

Season & Party Lighting Catalogue 2021-2022



Check price & stock

With a customer login you can check pricing and stock status, and use our webshop for easy online ordering. A real-time pricelist is available on our customer support page.

No customer login yet?

Use the contact form on our website or send us a mail to get you started.

Need more catalogues?

Let us know how many and we'll make sure you get them. The latest digital version of our catalogue is available via the downloads menu on our website.

sales@tronixlighting.com | +31 (0) 413-33 03 80.
We are happy to be of service for any questions or advice.

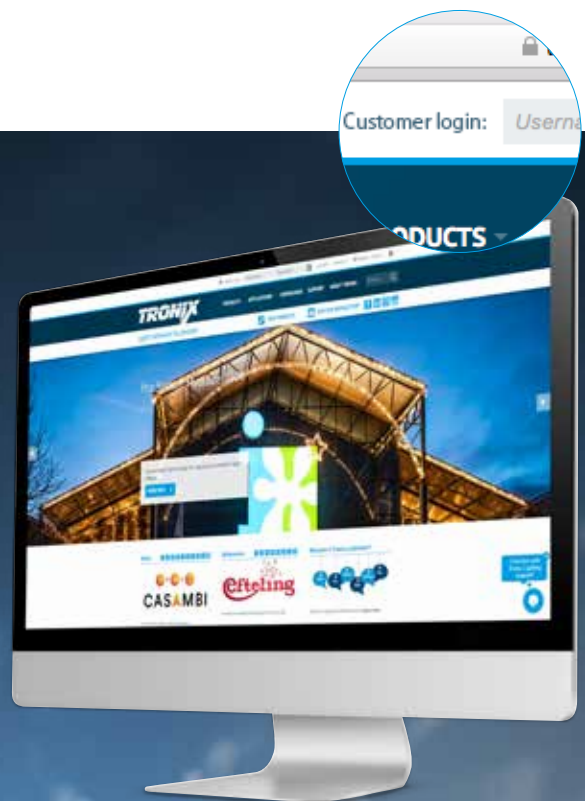

www.tronixlighting.com



6000 m²



2000 items



Fast delivery



Experience

About us



🇳🇱 **Tronix Lighting** is a Dutch family business that, as a stockholding supplier of Led lighting, has been specialized in lighting solutions for the professional market for the last 25 years. At this point, our product range offers a wide range of solutions for just any lighting demand you can think of, but decorative lighting has always been the heart of our company, the seed we once planted that has built us trust and position in the market. Over the years we have decorated many Efteling-'ish' type of buildings and objects with our professional ambient lighting, which is something we are really proud of. We believe in the power of caring, sharing and connecting. For and together with our customers, with expert and honest advice, tailor-made solutions and fast delivery times.

Season & Party Lighting from A-Z

The product range in this catalog is tailored for all-year-round decorative lighting purposes. For the simple reason that ambient lighting reaches further than the dark days alone and can serve any decorative purpose for 365 days a year! Whether it is decorating trees, buildings, streets and squares during Christmas or national holidays, a summer event, or a hotel that should always have an inviting appearance with beautiful lighting. So ambient lighting serves an important purpose all year round!

High quality indoor & outdoor lighting

Decorative lighting for outdoor use must meet high requirements: apart from being moisture- and weather resistant, it must also be able to take a blow or a punch, and have a multiple year life span. Holding our products in your hands, you will immediately feel the quality and flexibility of the cords and solid connecting plugs, easily convincing you that these are high quality professional products developed for sustainable use and user friendly installation. Our customers - including many installers of christmas lights and decoration specialists – can underline how important this is when having to process hundreds of meters of light strings and decoration every year!



Shopping Window with Pro System String Lights



Intratuin Shopping Center with Pro System String Lights

PHILIPS



LED Luminaire and Retrofit Bulbs Licensing Program

Member
Tronix Lighting BV



Tronix Lighting is een Hollands familiebedrijf dat als voorraadhoudende leverancier van Led verlichting al 25 jaar is gespecialiseerd in lichtoplossingen voor de professionele markt. Inmiddels dekt ons productaanbod alle denkbare lichttoepassingen, maar decoratieve verlichting blijft de kiem van ons bedrijf waarmee we vertrouwen en positie hebben opgebouwd in de markt. Door de jaren heen hebben we tal van Efteling-achtige panden en objecten van onze professionele Tronix sfeerverlichting mogen voorzien, en daar zijn we trots op! We geloven in de kracht van zorgen, delen en verbinden. Voor en samen met onze klanten, met deskundig en eerlijk advies, maatoplossingen en snelle levertijden.

Seizoens- en Feestverlichting van A-Z

Het productaanbod in deze catalogus is afgestemd op all-year-round decoratieve verlichtingsdoeleneinden. Om de eenvoudige reden dat sfeerverlichting verder reikt dan de donkere dagen alleen en 365 dagen per jaar een sfeervol doel kan dienen. Of het nu gaat om het decoreren van bomen, panden, straten en pleinen tijdens de kerstdagen en nationale feestdagen, het aankleden van een zomers event, of een hotel dat altijd mooi verlicht moet zijn. Sfeervolle verlichting dient het hele jaar door een belangrijk doel!

Hoge kwaliteit binnen- en buitenverlichting

Sfeerverlichting voor buiten moet aan hoge eisen voldoen: behalve vocht- en weersbestendig moet deze tegen een stootje kunnen en een aantal jaren meegaan. Zodra je onze producten in je handen hebt, voel je direct aan de kwaliteit en soepelheid van de snoeren en solide koppelstekkers dat het om professionele producten gaat, ontwikkeld voor duurzaam gebruik en gebruiksvriendelijke installatie. Onze klanten – waaronder veel installateurs van kerstverlichting en decoratiespecialisten – weten hoe belangrijk dit is als je jaarlijks honderden meters aan lichtsnoeren en decoratie verwerkt!



Tronix light decoration at residence in Uden - The Netherlands



6000 m² Tronix warehouse

CARE

We take care of our customers and help them do what they are good at. With a complete and high-quality product offering, holding stock, and providing the best support and aftercare.

Wij zorgen voor onze klanten en helpen hen om te doen waar ze goed in zijn. Met een compleet en hoogwaardig productaanbod, door voorraadhoudend te zijn en de beste ondersteuning en nazorg te bieden.

SHARE

Sharing knowledge means growing together. And 25 years of led expertise is something we want to share with our customers to help them better serve their end customers with maximum fitting lighting solutions.

Kennis delen betekent samen groeien. En 25 jaar Led expertise is iets wat we willen delen met onze klanten, om hen te helpen eindklanten (nog) beter van dienst te zijn met maximaal passende lichtoplossingen.

CONNECT

By connecting people and parties in the right way, new opportunities will arise. With an ever growing number of suppliers, it is important to look at the market as a larger whole. Working together instead of apart, and grant each other our unique business positions to serve end customers.

Door mensen en partijen op de juiste manier met elkaar te verbinden, ontstaan nieuwe kansen. Met een groeiend aantal leveranciers is het belangrijk om naar de markt als een groter geheel te kijken. Samenwerken in plaats van alleen, en elkaar onze unieke plek in de keten te gunnen in het voordeel van de eindklant.

TRONIX LIGHTING BV

Office

Vluchtoord 41, 5406 XP Uden
The Netherlands

Postal

Postbus 205, 5400 AE Uden
The Netherlands







Tel: +31 (0) 413 330380

E-mail: sales@tronixlighting.com

website: www.tronixlighting.com



A large number of articles are subject to an obligatory recycling fee for a lowest possible environmental impact; these costs are product related and specified on our site and your invoice.

1. PRO SYSTEM MODULAR 230V		8
2. PRO SYSTEM MODULAR 36V		24
3. TREE LIGHTING		34
4. MOTIFS		46
5. ROPE LIGHT		56
6. FESTOON CABLE LIGHT		64
7. LED CANDLES & STRINGS		70

Photography / Fotografie:

Fenna Gijswijt fotografie 

Hans Koster fotografie 

Adobe Stock Foto's

The images and information provided in this catalogue are composed with great care, but may be always subject to alterations. Tronix Lighting accepts no liability for misprints, errors or unforeseen changes.

De beelden en informatie zoals deze zijn weergegeven in deze catalogus zijn met zorg samengesteld maar blijven altijd onder voorbehoud. Tronix Lighting accepteert geen aansprakelijkheid voor drukfouten en onvoorziene wijzigingen.

“Never stop
amazing yourself”



IMPORTANT TO KNOW



CE APPROVED PRODUCTS

All our products come with a CE approval for EU-countries, complying with all legal regulations in the field of safety, health and the environment.



CE expires in the case of unauthorized modifications

In case of any changes or modifications made to our products, that are not specifically approved or recommended by Tronix, the CE approval expires and will no longer be valid.



LIGHT COLOR (KELVIN)

The Kelvin (K) value indicates the color temperature (CCT) of the Led. The lower the Kelvin value, the warmer the light. The higher the number of Kelvin, the 'colder' the light. The standard Kelvin values for Led lighting start at 2400K (Warm white) and runs up to 6500-7000K (Cold white).



Light color differences

Due to manufacturing tolerances, LED's may show small deviations in light color. Most of the time these are batch-related. This does not have any impact on product quality. Also, the light color can slightly change in time due to ageing. This is normal.



LIFESPAN

A good LED easily achieves a lifespan of 50.000 hours, however the actual lifetime of the Led strongly depends on the ambient temperature (in connection with cooling), and the electronics used. The more stable the strength of current, the longer the lifespan. The humidity level of the Led environment is also an influential factor. In the course of time, it is inevitable that the light output will eventually decrease to a maximum of 70%.



IP RATE

The IP value (Ingress Protection Rating) is expressed in 2 digits; the first number indicates the protection value against dust/touch, the second number the protection value against moisture. IP ratings for Led's vary from IP20 (poorly resistant to dust and moisture) to IP44 (water splash resistant) and up to IP67 - water resistant and 100% dust resistant.



CARTON QUANTITY

For all articles, the number of items that fits in the outer box is indicated by means of this symbol, which you will always find at the top of the product image. We call this the 'carton quantity', stating how many pieces of a particular product fit into the outer carton box. Good to know if you prefer full box deliveries or would like to keep a little more stock.



YEARS OF EXPERIENCE

Counting our many years of experience in developing (decorative) lighting, we have learned how to use our knowledge and expertise to bring high-quality products onto the market, meeting all European quality requirements and international technical standards. This means that our products are durable, high-quality in material and composition, as well as efficient and safe.

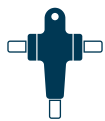

TRONIX EASY HANG-UP SYSTEM



Tronix Icicle Light is designed with an easy hang-up connection for quick application and fixing. This applies our connectable Icicle Lights from Pro System Modular 36V as well our 230V.



HIGH QUALITY RUBBER



For most decorative lighting products, Tronix uses high quality rubber cables, designed to provide high flexibility and withstand all weather conditions. The flexible rubber material is very easy to work with because it bends effortlessly in any direction e.g. when decorating a tree. Another advantage is that it does not break easily and 'works' with temperature.

BELANGRIJK OM TE WETEN

CE GECERTIFICEERDE PRODUCTEN

Al onze producten worden geleverd met voor de EU landen geldend CE-keurmerk. Deze voldoen daarmee aan alle wettelijke voorschriften op het gebied van veiligheid, gezondheid en het milieu.

! CE waarmerk vervalt bij ongeautoriseerde wijzigingen
In geval van wijzigingen of aanpassingen aan onze producten, die niet specifiek zijn goedgekeurd of aanbevolen door Tronix, vervalt de CE-goedkeuring en is deze niet langer geldig.

LEVENSDUUR

Een goede LED bereikt gemakkelijk een levensduur van 50.000 uur, maar de werkelijke levensduur van de led is sterk afhankelijk van de omgevingstemperatuur (in verband met koeling) en de gebruikte elektronica. Hoe stabiel de stroomsterkte, hoe langer de levensduur. De vochtigheidsgraad van de led-omgeving is ook een invloedrijke factor. In de loop van de tijd is het onvermijdelijk dat de lichtopbrengst uiteindelijk zal afnemen tot maximaal 70%.

OMDOOS AANTAL

Bij alle artikelen staat het aantal per omdoos vermeld aan de hand van dit symbooltje dat u steeds bovenaan de afbeelding aantreft. Dit betreft de 'carton quantity', oftewel het aantal items er van een bepaald artikel dat in een omdoos past. Handig om te weten als u graag wat meer op voorraad houdt of liever geen losse artikelen geleverd krijgt.

HANDIG TRONIX OPHANGSYSTEEM

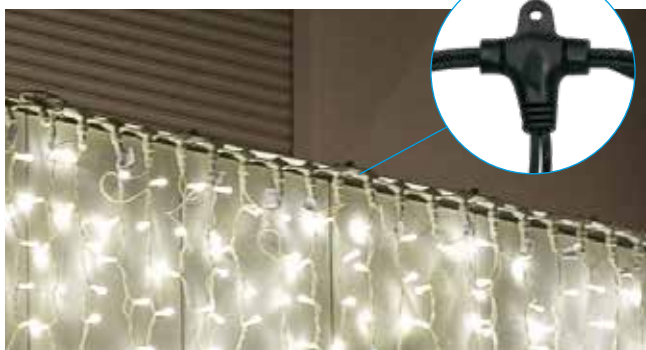

Tronix Icicle Light is ontworpen met een eenvoudig ophangstelsel voor een snelle en makkelijke manier van werken. Voor wat betreft de Icicle Lights zijn zowel de Pro System 230V als de 36V versies ermee uitgerust.

LED KLEUR (KELVIN)

De Kelvin (K) waarde geeft de kleurtemperatuur (CCT) van de Led aan. Hoe lager de Kelvin-waarde, hoe warmer het licht. Hoe hoger het aantal Kelvin, hoe 'kouder' het licht. De standaard Kelvin-waarde voor Led verlichting begint bij 2400K (warm wit) en loopt op tot 6500-7000K (koud wit).

! LED kleurverschillen
Vanwege productie toleranties kunnen Led's kleine afwijkingen in de lichtkleur vertonen. Meestal zijn deze batch-gerelateerd en heeft dit geen enkele invloed op de productkwaliteit. Ook kan de kleur van de Led na verloop van tijd enigszins veranderen door veroudering. Dit is een normaal verschijnsel.

IP RATE

De IP-waarde (Ingress Protection Rating) wordt uitgedrukt in 2 cijfers; het eerste cijfer geeft de beschermingswaarde aan tegen stof/aanraking, het tweede getal de beschermingswaarde tegen vocht. IP-waarden voor led's variëren van IP20 (slecht bestand tegen stof en vocht) tot IP44 (spatwaterbestendig) tot IP67 (waterbestendig en 100% stofbestendig).

25 JARENLANGE ERVARING

Met onze jarenlange ervaring in het ontwikkelen van (decoratieve) verlichting zijn we met onze kennis en expertise in staat om hoogwaardige producten in de markt te zetten die voldoen alle Europese kwaliteitseisen en internationale technische normeringen. Dit betekent dat onze producten niet alleen duurzaam en hoogwaardig in materiaal en compositie zijn, maar ook efficiënt en veilig.

HOGE KWALITEIT RUBBER



Voor de meeste decoratieve verlichtingsproducten maakt Tronix gebruik van rubberen kabels van hoge kwaliteit, ontworpen voor een hoge flexibiliteit en goede bestandheid tegen alle weersomstandigheden. Dit type materiaal is makkelijk om mee te werken omdat het heel buigzaam is en daarmee bij uitstek geschikt voor het decoreren van bomen en takken. Een ander voordeel van rubber is dat het 'werkt', oftewel dat het zich aanpast aan temperatuurverschillen en daarmee minder makkelijk breekt.

Pro System Modular 230V

Make your own light design:
choose your light components and
combine them any way you like

Whether you need to decorate a house, restaurant or department store – a window display, facade, column or tree – a balcony or a fence: the countless possibilities that Pro System 230V has to offer will absolutely do the trick and deliver that wow-effect you are looking for. So let your creativity flow freely and get started with your own light design!

Every object is unique and asks for a different approach when it comes to lighting it. So it is only logical that for maximum results, lighting products need to be customized in shape, size and color. And Tronix Pro System Modular 230V is your answer! A unique system that is different from conventional products in the sense that it offers no real 'finished' product. You make your own final product by composing individual components, giving you the flexibility you need to get maximum results and put your object literally in the spotlights.

With Tronix Pro System Modular you choose for an efficient and versatile approach with great benefits. With the countless possibilities and product combinations of this system you can capture effects where you need them and enjoy the smashing results.

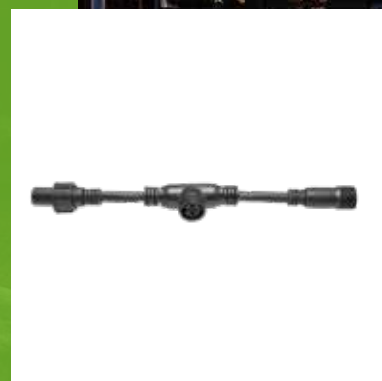



Intratuin Garden Center, with Pro System 230V String Lights- IDI Projects

Pro System Modular 230V | Introduction

CREATING YOUR OWN LIGHT DESIGN: HOW DOES IT WORK?

In terms of size and application: you can create light curtains of almost unlimited size so there is no object too big or too small. Up to 1200 points of light or 120m in length are possible with only one feed. Another advantage is that you can expand your system at any given moment in time.

But how do you start creating your personal light decoration? This is how it works:

Step 1 Choose your object(s)

Picture your object as a whole and decide which parts you want to put in the spotlight. Facades, windows, window displays, trees, staircases, balconies: anything you can think of that would be worth while decorating.

Step 2 Choose the wire color ○ ●

Tronix Pro System Modular offers a choice between black and white cable color. We advise you to stick with one color for all components you are planning to use. For Tree Lighting the common color is black.

Step 3 Choose the structure for your light plan

Take a look at the product components of Pro System Modular and find out which lighting solutions make the best fit with your lighting objects. Look for a total solution, bearing in mind that a window asks for a different lighting solution than a façade.

You can choose to make custom-made light curtains to cover windows, pillars, balconies, stairs and many other objects. You can integrate cone-shaped trees in your light curtain design by using a special tree string divider. You can make connections with 2D and 3D motifs for complete results. And you can use Icicle Lights for a classy decoration of facades.



Step 4 Choose the light color

Select the desired light color of the light strings and other product components.

- Warm white Plus+ (2400K)**
Very warm light for pleasant atmosphere. Popular to use for a.o. bars, restaurants and hotels and to emphasize wooden buildings or event areas.
- Warm white (3000K)**
Pleasant warm light, suitable for hotels, shopping malls, passages, to emphasize buildings, event areas, shops.
- Flashing (Warm) white**
For vivid and playful effects: use a combination of steady Warm White and Flashing White or Warm White led's.
- Cold white (6500K)**
Similar to daylight. Suitable for ice bars, events and to emphasize concrete buildings and shops.

Step 5 Choose your object(s)

Making light curtains

To make light curtains you need to find the right combination of main cables and light strings to get the result you are looking for. This is what you do:

- Calculate cable quantity for desired curtain width**
Establish the required width of your light curtain(s) and calculate how many main cables in which size you need to reach it. A light curtain is nothing more than the combination of main cables and String Lights. Main cables are connectable to achieve any desired size.

- Determine type and quantity of light strings for the right length**
Based on the desired drop-down length and available connectable and non-connectable string lights: split the total length into end strings and connection strings and decide how many light strings you need in which size.

Example: if you need a string with 9 meter length, you take a 6 meter connectable string and connect it with a 3 meter end string. Decide how many 'finished' strings you need for your main cables. These have – depending on their size – 6, 12 or 24 sockets and can hold an equal number of finished strings (1 string per socket).

- Need assistance?**
We are happy to help you out so please don't hesitate to contact us.



Introduction | Pro System Modular 230V

Choosing additional lighting components

- Decide whether you want to integrate cone tree lighting (with a Cone Tree divider, see page 13)
- Decide whether you want to integrate motifs in your light design and make a selection (see page 52-55).
- Decide if and where you need to integrate Icicle light to decorate facades (see page 20-21).

Choose the accessories you need for your light design

Walk through your light design and select the the power cables and accessories you need (see page 22-23). Make sure you don't forget to order extra power when required, or any extra accessories that you will need to make certain connections, like e.g. when integrating tree light, motifs, or T-sections.

Step
6

Connect all components and assemble

Make sure to close off any un-used (free) connections with an end cap.

Good luck with your design and enjoy the result!

proSYSTEM LED
MODULAR 230V



PRO SYSTEM MODULAR

Tronix Pro System Modular: a decorative, IP65 rated lighting range that gives you the flexibility to make your own customized product. With long durability, user friendliness and maximum light results:

Features

- IP65
- Round Led
- Advanced material composition for a long life span and easy to use
- Matching light colors with Rope Light for uniform light effects when integrated
- Compatible with Pro System Modular IP44 (previous range)

IP65



IP65 WITH ROUND LED

Residential building with Tronix Pro System Modular light curtains - ID Light, Nistelrode, the Netherlands

Pro System Modular 230V | Main Cables

MAIN CABLES FOR LIGHT STRINGS

Connectable main cables for light curtains (Power cable not included)



- The first step is to determine the cable colors of your system. Tronix offers choice between a white or black rubber cable.
- Then determine the quantity and size of the main cables you would need to reach the desired width for your light curtain.

Input voltage: 230V

IP rate: IP65

Material: Rubber

MAIN CABLES - SMALL

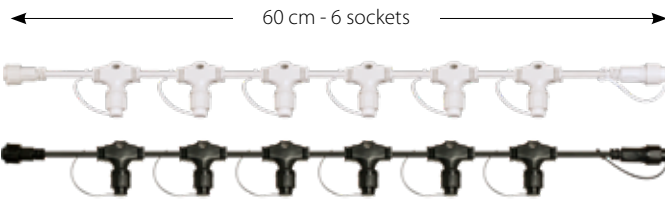

MAIN CABLES - MEDIUM

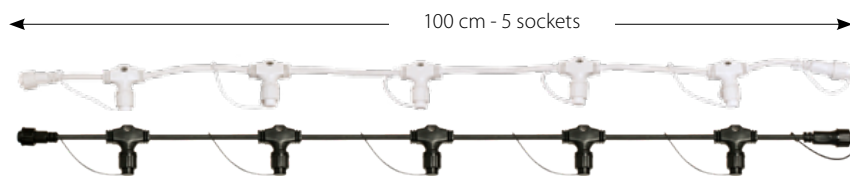

MAIN CABLES - MEDIUM

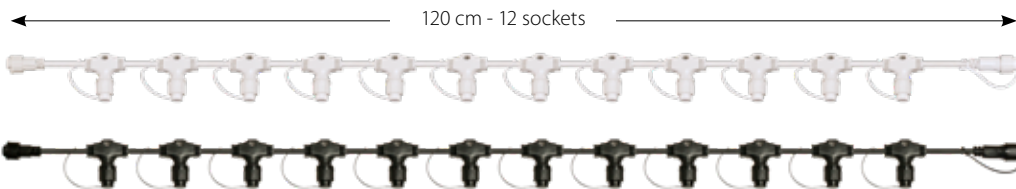

MAIN CABLES - LARGE



MAIN CABLES - XL



ART. NR.	DESCRIPTION	LENGTH	COLOR	SOCKETS	SOCKET DISTANCE	CARTON QTY.
010-113	Main Cable - Small	60 cm	○ White	6	10 cm	40
010-114	Main Cable - Small	60 cm	● Black	6	10 cm	40
010-007	Main Cable - Medium	100 cm	○ White	5	20 cm	20
010-006	Main Cable - Medium	100 cm	● Black	5	20 cm	20
010-105	Main Cable - Medium	120 cm	○ White	12	10 cm	20
010-106	Main Cable - Medium	120 cm	● Black	12	10 cm	20
010-107	Main Cable - Large	240 cm	○ White	24	10 cm	10
010-108	Main Cable - Large	240 cm	● Black	24	10 cm	10
010-115	Main Cable - XL	500 cm	● Black	5	100 cm	20

36V Modular Lighting System

Need to light a public area? Check out the possibilities with our 36V Modular Lighting System!

Create your light design with the safe, low voltage lighting components of Pro System Modular 36V. With transparent, black or white wire and choice between Warm White (3000K), Warm white+ (2400K) or Cold White (6500K)



WHICH POWER CABLES DO YOU NEED?

How much power and which power cables you need all depends on the amount and length of light strings that you need for your light design.

The first step is to make your selection of strings; the next is to determine how much power you need based on the total nr. of Led's. Have a look at the calculation examples and the complete overview of power-, extension cables and accessories on page 22-23

Main Cables | Pro System Modular 230V

MAIN CABLE DIVIDER FOR CONE TREES

Connectable divider for light decoration of cone shaped trees



- This connectable main cable tree divider makes it possible to easily decorate one or more cone shaped trees as part of your lighting project.
- For larger or wider cone shaped trees, you can connect a second or third divider and expand the connections by ten pieces at a time.
- Make sure to close off any unused connections with an end cap (check accessories). When decorating trees, the recommended cable color is black.
- Excluding power cable and light strings

Input voltage: 230V
Outlets: 10
IP rate: IP65
Material: Rubber (black)

Connectable: Yes (other dividers/
 main cables)
Power cable: not included
End caps: not included



Cone Tree Divider - 10 outlets
 Connectable with more dividers or other main cables



Illustration of divider with connected strings (10)



Visual impression using 1 divider with strings.
 Connect more dividers & strings for larger trees.

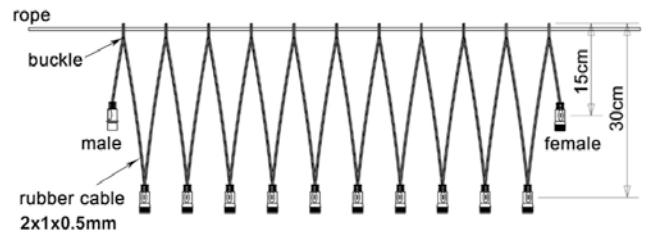

ART. NR.	DESCRIPTION	OUTLETS	CARTON QUANTITY
010-109	Cone light string divider	10	5

LIGHT STRINGS 10 PER DIVIDER	LIGHT CO- LOR (CCT)	6M - 1 STRING 60 LED'S P/S	PER DIVIDER	3M - 1 STRING 30 LED'S P/S	PER DIVIDER
Light string ● Cold white	○ 6500K	011-211	10 pcs (600 led's)	-	-
Light string ● Warm white	○ 3000K	011-218	10 pcs (600 led's)	011-118	10 pcs (300 led's)
Light string ● Warm white+	○ 2400K	011-232	10 pcs (600 led's)	011-125	10 pcs (300 led's)
Light string ● Warm white & Flash	○ 3000K/3000K	011-220	10 pcs (600 led's)	011-120	10 pcs (300 led's)

* For a complete overview of available light string sizes and colors - see page 14-15

ART. NR.	POWER CABLES & ACCESSORIES*	MAX. NR. LED'S
010-013	LED Power Cable Black EU - 2 Ampère	6.000
010-019	LED Power Cable Black EU - 5 Ampère	15.000
010-195	End cap Black (to close of unused sockets)	

* For a complete overview of Pro System 230V Accessories - see page 22-23



CALCULATION EXAMPLES:

- To decorate 5 medium-sized cone-shaped trees you need 5 dividers and 50 * 3M strings (30 led's per string). For a total of 1.500 Led's you need 1* Power Supply 2 Ampère.
- To decorate 5 small sized cone-shaped trees you need 5 dividers and 25 * 1,5M strings (set of 2 - 15 led's per string). For a total of 750 Led's you need 1* Power Supply 2 Ampère.
- To decorate 10 large cone-shaped trees you need 10 dividers and e.g. 100 * 6M strings (60 led's per string). For a total of 6.000 Led's you need 1* Power Supply 2 Ampère.
- To decorate 12 large cone/conifer trees you need 12 dividers and e.g. 120 * 6M strings (60 led's per string). For a total of 7.200 Led's you need 1* Power Supply 5 Ampère

Pro System Modular 230V | Connectable Strings

CONNECTABLE STRING LIGHTS - 10M

Compose your light curtain with our selection of strings



- Input voltage:** 230V
- Power:** 6,8 Watt
- Length:** 10 meter
- Nr. of strings:** 1
- IP rate:** IP65
- Material:** Rubber (black or white)
- Connectable:** Yes
(other dividers/main cables)
- Power cable:** not included
- End caps:** included
- Carton quantity:** 10



ART. NR.	WIRE COLOR	LIGHT COLOR	COLOR TEMP.	LED'S P/STRING
011-151	● Black	○ Cold white	6500K	100
011-158	● Black	○ Warm white	3000K	100
011-159	● Black	○ Warm white+	2400K	100
011-165	● Black	○* Warm white (90) & Warm white Flash (10)	3000K & 3000K	90/10
011-156	NEW ● Black	○* Warm white+ (80) & Cold white Flash (20)	2400K & 6500K	80/20
011-161	○ White	○ Cold white	6500K	100
011-168	NEW ○ White	○ Warm white	3000K	100
011-162	○ White	○ Warm white+	2400K	100
011-157	NEW ○ White	○* Warm white+ (80) & Cold white Flash (20)	2400K & 6500K	80/20

ART. NR.	WIRE COLOR	POWER CABLES*	MAX. NR. LED'S
010-013	● Black	LED Power Cable Black EU - 2 Ampère	6.000
010-019	● Black	LED Power Cable Black EU - 5 Ampère	15.000
010-012	○ White	LED Power Cable White EU - 2 Ampère	6.000
010-020	○ White	LED Power Cable White EU - 5 Ampère	15.000

Calculation example 1: For a 6 meter 3000K light curtain (black wire) and 10 meter length you need:

Main cable - Black - 240cm - 24 sockets	Art. nr. 010-108	2 pc	48 sockets
Main cable - Black - 120cm - 12 sockets	Art. nr. 010-106	1 pc	12 sockets
Light string 10m - Black - 3000K	Art. nr. 011-158	60 pcs	6000 Led's

Total amount of Led's to empower: 60 strings à 100 led's p/string = 6000 Led's

Power cable Black - 2 Ampère - max. 6000 Led's	Art. nr. 010-013	1 pc
--	------------------	------

Which and how many power cables you need depends on the total amount of led's that needs to be empowered. If this total is more than 15.000 led's (the maximum number you can empower on 1 power cable of 5 Ampère) you need to make 2 curtains



PRO SYSTEM MODULAR

Tronix Pro System Modular: a range of IP65 components, giving you the flexibility to make your own customized product. With a long durability, user friendliness and maximum light results:

Features

- IP65
- Round Led
- Advanced material composition for a long life span and easy to use
- Matching light colors with Rope Light for uniform light effects when integrated
- Compatible with Pro System Modular IP44 (previous range)

Connectable Strings | Pro System Modular 230V

CONNECTABLE STRING LIGHTS - 6M

Compose your light curtain with our selection of strings



- Input voltage:** 230V
- Power:** 4,6 Watt
- Length:** 6 meter
- Nr. of strings:** 1
- IP rate:** IP65
- LED distance:** 10 cm
- Material:** Rubber (black or white)
- Connectable:** Yes
(other dividers/main cables)
- Power cable:** not included
- End caps:** included
- Carton quantity:** 10

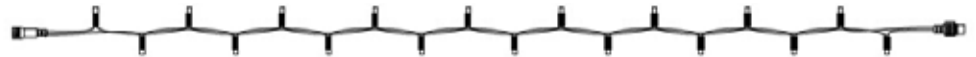

ART. NR.	WIRE COLOR	LIGHT COLOR	COLOR TEMP.	LED'S P/STRING
011-211	● Black	○ Cold white	6500K	60
011-218	● Black	○ Warm white	3000K	60
011-232	● Black	○ Warm white+	2400K	60
011-220	● Black	○* Warm white (54) & Warm white Flash (6)	3000K & 3000K	54/6
011-233	● Black	○* Warm white+ (48) & Cold white Flash (12)	2400K & 6500K	48/12
011-221	○ White	○ Cold white	6500K	60
011-228	○ White	○ Warm white	3000K	60
011-231	○ White	○ Warm white+	2400K	60
011-234	○ White	○* Warm white+ (48) & Cold white Flash (12)	2400K & 6500K	48/12

ART. NR.	WIRE COLOR	POWER CABLES*	MAX. NR. LED'S
010-013	● Black	LED Power Cable Black EU - 2 Ampère	6.000
010-019	● Black	LED Power Cable Black EU - 5 Ampère	15.000
010-012	○ White	LED Power Cable White EU - 2 Ampère	6.000
010-020	○ White	LED Power Cable White EU - 5 Ampère	15.000



Calculation example 2: For a 12 meter 2400K light curtain (white wire) with 13 meter drop-down:

Main cable - White - 240cm	Art. nr. 010-107	5 pcs	120 sockets
Light string 10m white wire - 2400K - 100 Led's p/string	Art. nr. 011-162	120 pcs	12000 led's
End strings 3m white wire - 2400K - 30 Led's p/string	Art. nr. 011-124	120 pcs	3600 led's (total of 15.600 led's)

Total amount of Led's to empower: 120 strings à 130 led's p/string = 15.600 Led's (not possible to empower with one power supply)

Conclusion: for a curtain this size you need to split it in two parts and use an extra power supply

The easiest way is to split the curtain in two equal parts and use matching power supplies for each part. The 'split' in curtains does not have to be noticeable when you empower the curtains on the far left and the far right end.

For each curtain (total 2)

	Art. nr.	Curtain 1	Curtain 2	Per curtain
Main cable - White - 240cm	010-107	2 pcs	2 pcs	48 sockets
Main cable - White - 120cm	010-105	1 pcs	1 pcs	12 sockets
Light string 10m white wire - 2400K - 100 Led's p/string	011-162	60 pcs	60 pcs	6000 Led's
End strings 3m white wire - 2400K - 30 Led's p/string	011-124	60 pcs	60 pcs	1800 Led's

Total amount of Led's to empower per curtain: 60 strings à 130 led's p/string = 7.800 Led's

Power cable White - 5 Ampère - max. 15.000 Led's	Art. nr. 010-020	2 pcs
--	------------------	-------

Pro System Modular 230V | End Strings

END STRING | 3M | 1 STRING

Non connectable cascade strings for custom-made light curtains



- Input voltage:** 230V
- Power:** 2,3 Watt
- Length:** 3 meter
- Nr. of strings:** 1
- IP rate:** IP65
- LED distance:** 10 cm
- Material:** Rubber (black or white)
- Connectable:** No
- Power cable:** not included
- End caps:** included
- Carton quantity:** 20

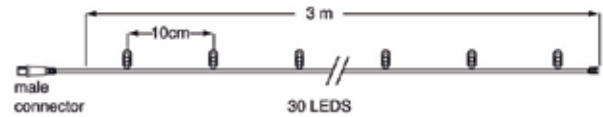

ART. NR.	WIRE COLOR	LIGHT COLOR	COLOR TEMP.	LED'S P/STRING
011-118	● Black	○ Warm white	3000K	30
011-125	● Black	○ Warm white +	2400K	30
011-120	● Black	○* Warm white (27) & Warm white Flash (3)	3000K & 3000K	27/3
011-116 NEW	● Black	○* Warm white+ (24) & Cold white Flash (6)	2400K & 6500K	24/6
011-128	○ White	○ Warm white	3000K	30
011-124	○ White	○ Warm white +	2400K	30
011-117 NEW	○ White	○* Warm white+ (24) & Cold white Flash (6)	2400K & 6500K	24/6

ART. NR.	WIRE COLOR	POWER CABLES*	MAX. NR. LED'S
010-013	● Black	LED Power Cable Black EU - 2 Ampère	6.000
010-019	● Black	LED Power Cable Black EU - 5 Ampère	15.000
010-012	○ White	LED Power Cable White EU - 2 Ampère	6.000
010-020	○ White	LED Power Cable White EU - 5 Ampère	15.000



EASY INTEGRATION OF 2D/3D MOTIFS IN YOUR LIGHT DESIGN:

Tronix offers a selection of motifs with a special connection plug for easy integration with Pro System Modular 230V. 3D decorative light balls as well as twinkling stars and snowflakes can be combined with light strings and curtains to give an extra dimension to your light design.

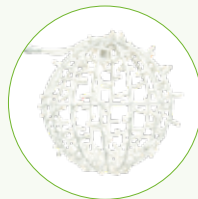

Decorative light balls in 4 sizes
White or Warm white with Flash



1 male plug for connecting the ball to the power cable
1 female plug to connect it to a set light strings



Y-connector for coupling with Pro System 230V
See accessories P22-23

End Strings | Pro System Modular 230V

END STRING | 1,5M | 2 STRINGS

Non-connectable cascade strings for custom-made light curtains



proSYSTEM LED MODULAR 230V

- Input voltage:** 230V
- Power:** 2,3 Watt
- Length:** 1,5 meter
- Nr. of strings:** 2
- IP rate:** IP65
- LED distance:** 10 cm
- Material:** Rubber (black or white)
- Connectable:** No
- Power cable:** not included
- End caps:** included
- Carton quantity:** 20



ART. NR.	WIRE COLOR	LIGHT COLOR	COLOR TEMP.	LED'S P/STRING
011-171	● Black	○ Warm white	3000K	2 x 15
011-173 NEW	○ White	○ Cold white	6500K	2 x 15
011-172	○ White	○ Warm white	3000K	2 x 15
011-183 NEW	○ White	○ Warm white+	2400K	2 x 15

END STRING | 0,8M | 4 STRINGS

Non-connectable cascade strings for custom-made light curtains



proSYSTEM LED MODULAR 230V

- Input voltage:** 230V
- Power:** 2,4 Watt
- Length:** 0,8 meter
- Nr. of strings:** 4
- IP rate:** IP65
- LED distance:** 10 cm
- Material:** Rubber (black or white)
- Connectable:** No
- Power cable:** not included
- End caps:** included
- Carton quantity:** 18



ART. NR.	WIRE COLOR	LIGHT COLOR	COLOR TEMP.	LED'S P/STRING
011-176	● Black	○ Warm white	3000K	4 x 8
011-186 NEW	● Black	○ Warm white+	2400K	4 x 8
011-175	○ White	○ Warm white	3000K	4 x 8
011-177 NEW	○ White	○ Cold white	6500K	4 x 8

ART. NR.	WIRE COLOR	POWER CABLES FOR 3/1,5/0,8M END STRINGS	MAX. NR. LED'S
010-013	● Black	LED Power Cable Black EU - 2 Ampère	6.000
010-019	● Black	LED Power Cable Black EU - 5 Ampère	15.000
010-012	○ White	LED Power Cable White EU - 2 Ampère	6.000
010-020	○ White	LED Power Cable White EU - 5 Ampère	15.000

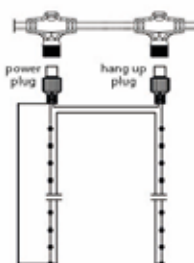
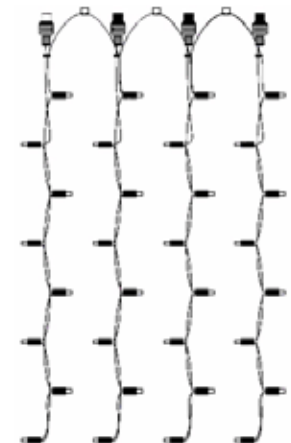

END STRINGS 1,5M & 0,8M

One plug for power, the other one for hang-up only (no contact/power)

Pro System Modular 230V | Cluster Lights 2M

CLUSTER LIGHT | 2M | CONNECTABLE

Light string containing side branches with small lights for easy decoration of tree branches, facades or other objects. Apply hanging down in series or connect them in any desired way for a custom-made light design.



proSYSTEM
MODULAR LED 230V

Input voltage: 230V

Power: 7 Watt

Length: 200 cm

IP rate: IP65

Connectable: Yes

Power cable: not included

Led's total: 120

led distance: 1,67 cm

Material: Rubber (black or white)

End caps: Included

Carton quantity: 10

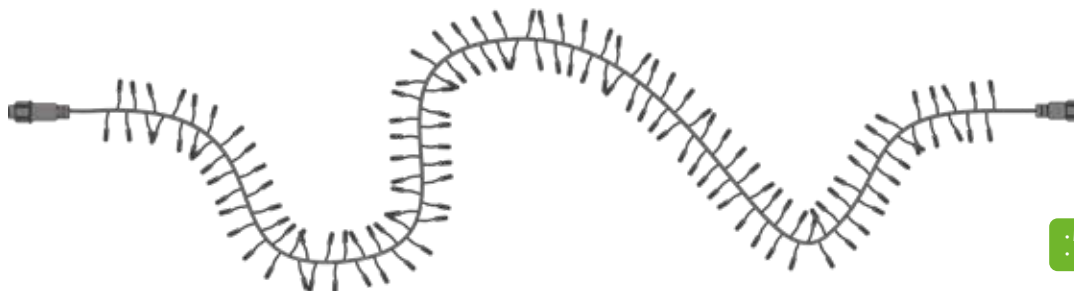

• MALE AND FEMALE CONNECTOR
• 1 STRING TOTAL - 120 LED'S

ART. NR.	WIRE COLOR	LIGHT COLOR	COLOR TEMP.	LED'S
012-001	● Black	○ Cold white	6500K	120
012-002	● Black	○ Warm white	3000K	120
012-003	● Black	○ Warm white+	2400K	120
012-009 NEW	● Black	○* Warm white+ (96) & Cold white Flash (24)	2400K & 6500K	96/24
012-011	○ White	○ Cold white	6500K	120
012-012	○ White	○ Warm white	3000K	120
012-013	○ White	○ Warm white+	2400K	120
012-019 NEW	○ White	○* Warm white+ (96) & Cold white Flash (24)	2400K & 6500K	96/24

Cluster Lights 3M | Pro System Modular 230V

CLUSTER LIGHT | 3M | CONNECTABLE

Light string containing side branches with small lights for easy decoration of tree branches, facades or other objects. Apply hanging down in series or connect them in any desired way for a custom-made light design.



- Input voltage:** 230V
- Power:** 10,5 Watt
- Length:** 300 cm
- IP rate:** IP65
- Connectable:** Yes
- Power cable:** not included
- Led's total:** 180
- led distance:** 1,67 cm
- Material:** Rubber (black or white)
- End caps:** Included
- Carton quantity:** 10

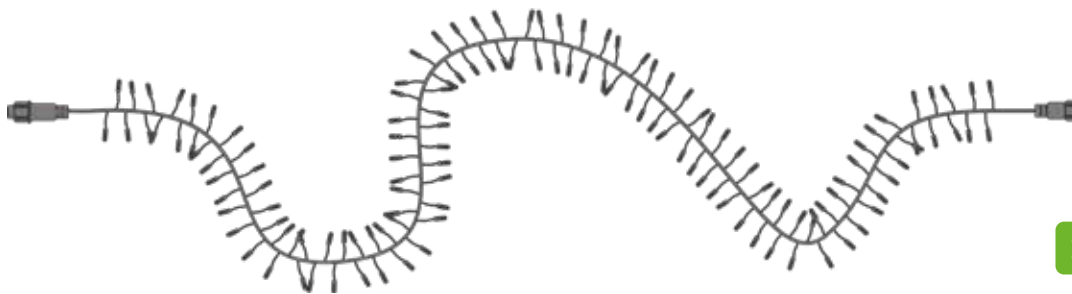

• MALE AND FEMALE CONNECTOR
• 1 STRING TOTAL - 180 LED'S

ART. NR.	WIRE COLOR	LIGHT COLOR	COLOR TEMP.	LED'S
012-021	● Black	○ Cold white	6500K	180
012-022	● Black	○ Warm white	3000K	180
012-023	● Black	○ Warm white+	2400K	180
012-031	○ White	○ Cold white	6500K	180
012-032	○ White	○ Warm white	3000K	180
012-033	○ White	○ Warm white+	2400K	180



CLUSTER LIGHT: CHAMPION IN VERSATILITY

Versatility is the key word for these popular decorative lights, recognizable by a 'clustered' look because of the abundance of magical mini LED lights located on the side branches of the string. Application is as versatile as it gets: for easy decoration of christmas trees or tree branches, facades or windows, or to accentuate any other object you can think of, such as doors, gates, or railings.



Designed to connect for custom-made designs and large projects

Being part of Tronix Pro System Modular, our connectable Cluster Light strings are especially designed to be integrated in light designs for large objects and trees (>3 meters). Apply them hanging down in series, or connect in any other desired way for custom-made and spectacular light designs.

Pro System Modular 230V | Icicle Lights

ICICLE LIGHT PRO 2M X 0,4M | CONNECTABLE

For horizontal applications, stand alone use or between main cables

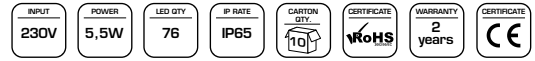

- Input voltage:** 230V
- Power:** 5,5 Watt
- Length:** 200 x 40 cm
- IP rate:** IP65
- Connectable:** Yes
- Power cable:** not included
- Nr. of strings:** 20
- Led's per string:** 3-4-5
- Led's total per set:** 76
- Material:** Rubber (black or white)
- End caps:** Not included
- Carton quantity:** 10

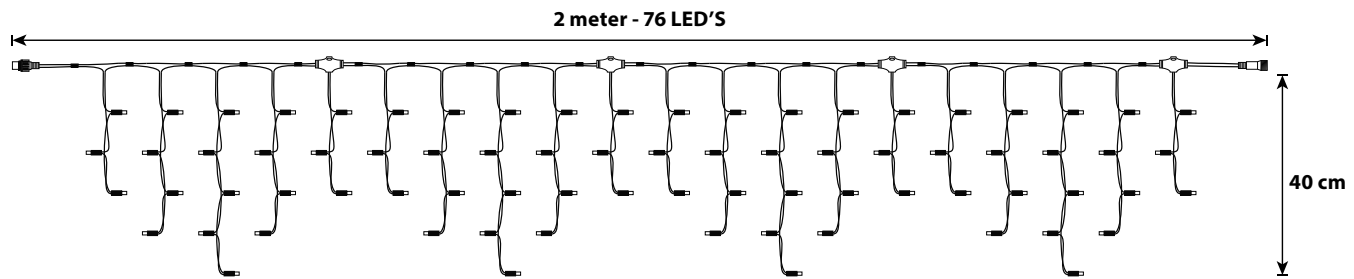

• MALE AND FEMALE CONNECTOR
• 20 STRING TOTAL - 76 LED'S

ART. NR.	WIRE COLOR	LIGHT COLOR	COLOR TEMP.	LED'S
007-141	● Black	○ Cold white	6500K	76
007-008	● Black	○ Warm white	3000K	76
007-020	● Black	○ Warm white+	2400K	76
007-025	● Black	○ Warm white (72) & Warm white Flash (4)	3000K & 3000K	72/4
007-029	● Black	○ Warm white+ (68) & Cold white Flash (8)	2400K & 6500K	68/8
007-140	○ White	○ Cold white	6500K	76
007-018	○ White	○ Warm white	3000K	76
007-019	○ White	○ Warm white+	2400K	76
007-026	○ White	○ Warm white (72) & Warm white Flash (4)	3000K & 3000K	72/4
007-030	○ White	○ Warm white+ (68) & Cold white Flash (8)	2400K & 6500K	68/8

Icicle Lights | Pro System Modular 230V

ICICLE LIGHT PRO 2M X 0,8M | CONNECTABLE

For horizontal applications, stand alone use or between main cables



- Input voltage:** 230V
- Power:** 11 Watt
- Length:** 200 x 80 cm
- IP rate:** IP65
- Connectable:** Yes
- Power cable:** not included
- Nr. of strings:** 20
- Led's per string:** 6-8-10
- Led's total per set:** 152
- Material:** Rubber (black or white)
- End caps:** Not included
- Carton quantity:** 10

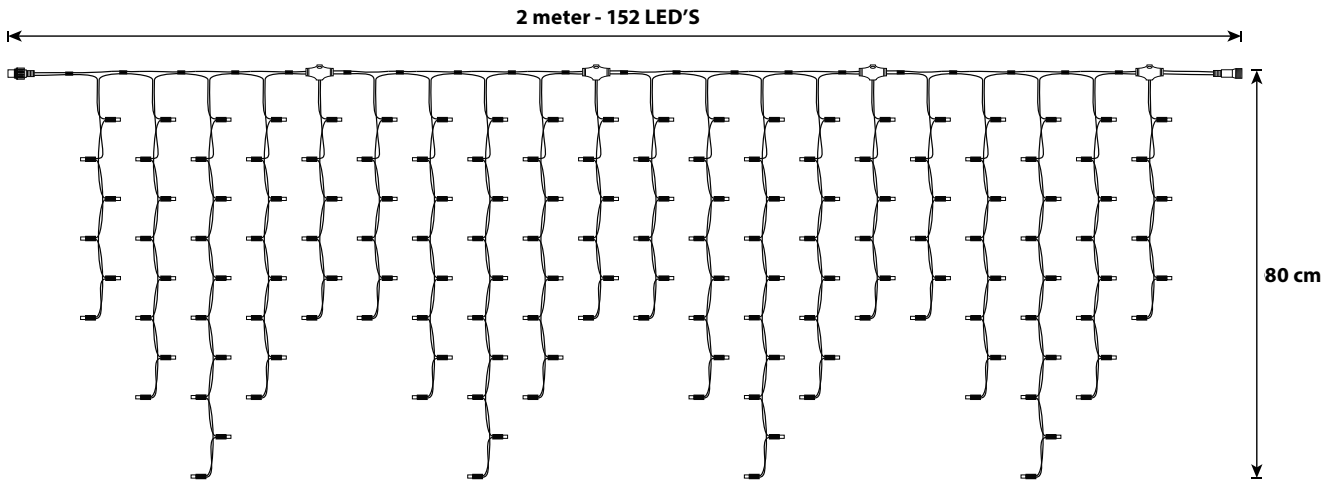

• MALE AND FEMALE CONNECTOR
• 20 STRING TOTAL - 152 LED'S

ART. NR.	WIRE COLOR	LIGHT COLOR	COLOR TEMP.	LED'S
007-050	● Black	○ Cold white	6500K	152
007-048	● Black	○ Warm white	3000K	152
007-052	● Black	○ Warm white+	2400K	152
007-053	● Black	○* Warm white (144) & Warm white Flash (8)	3000K & 3000K	144/8
007-049	○ White	○ Cold white	6500K	152
007-058	○ White	○ Warm white	3000K	152
007-051	○ White	○ Warm white+	2400K	152
007-054	○ White	○* Warm white (144) & Warm white Flash (8)	3000K & 3000K	144/8

Pro System Modular 230V | Accessories



ART. NR.	POWER CABLE BLACK 2 & 5 AMPÈRE
Ⓐ 010-013	● LED Power Cable Black EU - 2 Ampère (6.000 Led's)
Ⓐ 010-019	● LED Power Cable Black EU - 5 Ampère (15.000 Led's)

ART. NR.	POWER CABLE WHITE 2 & 5 AMPÈRE
Ⓑ 010-012	○ LED Power Cable White EU - 2 Ampère (6.000 Led's)
Ⓑ 010-020	○ LED Power Cable White EU - 5 Ampère (15.000 Led's)

ART. NR.	EXTENSION CABLE BLACK 0,5M - 5M
Ⓒ 010-201	● Extension Cable Black - 0,5 meter
Ⓒ 010-203	● Extension Cable Black - 1 meter
Ⓒ 010-205	● Extension Cable Black - 2 meter
Ⓒ 010-207	● Extension Cable Black - 3 meter
Ⓒ 010-209	● Extension Cable Black - 5 meter

ART. NR.	EXTENSION CABLE WHITE 0,5M - 5M
Ⓓ 010-200	○ Extension Cable White - 0,5 meter
Ⓓ 010-202	○ Extension Cable White - 1 meter
Ⓓ 010-204	○ Extension Cable White - 2 meter
Ⓓ 010-206	○ Extension Cable White - 3 meter
Ⓓ 010-208	○ Extension Cable White - 5 meter

ART. NR.	END CAPS BLACK & WHITE
Ⓔ 010-195	● End cap black
Ⓔ 010-196	○ End cap white

Accessories | Pro System Modular 230V

proSYSTEM LED
MODULAR 230V

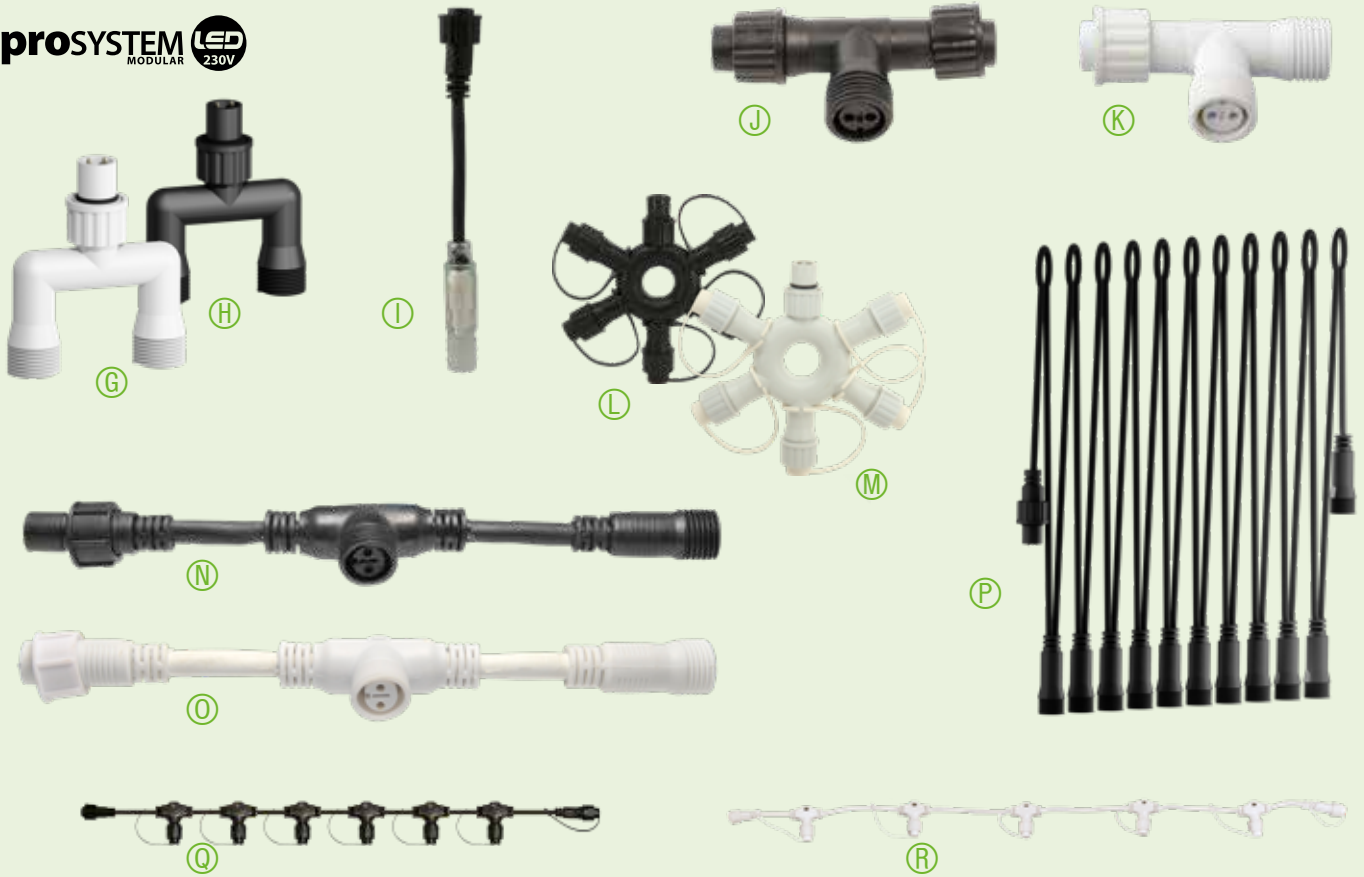

ART. NR.	CONNECTORS
Ⓒ 010-199	○ Y-connector White
Ⓗ 010-198	● Y-connector Black
Ⓙ 010-004	● T-section-Connector Compact Black (2 pcs)
Ⓚ 010-005	○ T-section-Connector Compact White (2 pcs)
Ⓛ 010-189	● Ring connector 5-way Black
Ⓜ 010-188	○ Ring connector 5-way White
Ⓝ 010-023	● T-Connector Flexible Black 25 cm
Ⓞ 010-022	○ T-Connector Flexible White 25 cm
Ⓟ 010-006	● 5-Connector String 1 m Black
Ⓡ 010-007	○ 5-Connector String 1 m White

ART. NR.	SPECIAL ACCESSORIES
Ⓛ 010-197	● Connector 15 cm for Rope Light 13mm Black
Ⓟ 010-109	● Cone Tree divider with 10 connector strings 30 cm Black Connectable (see P13)

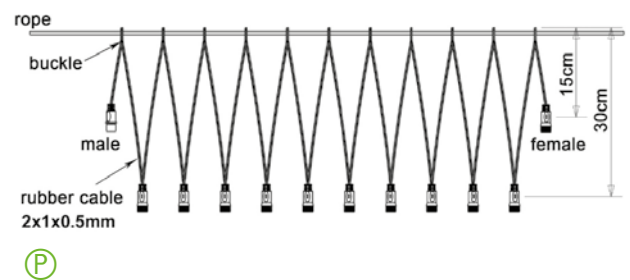
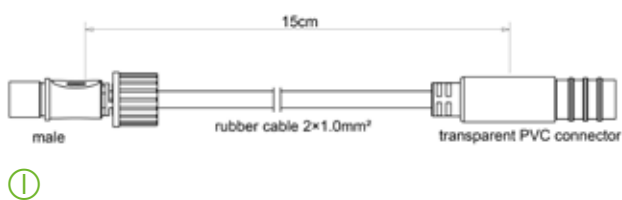

Pro System Modular 36V

Low voltage modular lighting system to create safe light designs in public places like community parks, malls and squares

Already familiar with Tronix Pro System Modular 230V Then you know about its endless possibilities in light design and applications, not be limited by anything but your own imagination! Define your object, get creative and choose the right lighting components to create any desired light result.

When it comes to lighting places where people shop, meet or spend their leisure time, safety comes first. This is why Tronix - based on the success of Pro System Modular 230V - has introduced a 36V version to meet professional lighting requirements in the public segment.

Tronix Pro System Modular 36V offering choice between 3M, 6M and 10M connectable light strings, or Icicle Lights in a length of 40 cm and 80 cm in two shades of warm white. To integrate Motifs and Rope light in your light design please use Pro System Modular 230V.



NEW

36V Modular Lighting System for safe and attractive lighting in public places

Create your light design with the safe, low voltage lighting components of Pro System Modular 36V. Now available with White or Black wire, and choice between Warm White 3000K, Warm White+ (2400K) or Cold White (6500K)

proSYSTEM 
MODULAR

Pro System Modular 36V | Introduction

HOW TO CREATE SAFE & ATTRACTIVE LIGHT DESIGNS IN PUBLIC AREAS

In terms of size and application: you can create light curtains of almost unlimited size so there is no object too big or too small. Up to 1200 points of light or 120m in length are possible with only one feed. Another advantage is that you can expand your system at any given moment in time. But how do you start creating your personal light decoration? This is how it works:

Step 1 Choose your object(s)

Picture your object as a whole and decide which parts you want to put in the spotlight. Facades, windows, window displays, trees, staircases, balconies: anything you can think of that would be worth while decorating.

Step 2 Choose the wire color ○ ○ ●

Tronix Pro System Modular 36V offers a choice between transparent, black and white cable color. We advise you to stick with one color for all components you are planning to use. For Tree Lighting the common color is black.

Step 3 Choose the structure for your light plan

Take a look at the product components of Pro System Modular and find out which lighting solutions make the best fit with your lighting objects. Look for a total solution, bearing in mind that a window asks for a different lighting solution than a façade.

You can choose to make custom-made light curtains to cover windows, pillars, balconies, stairs and many other objects. You can integrate coneshaped trees in your light curtain design by using a special tree string divider. You can make connections with 2D and 3D motifs for complete results. And you can use Icicle Lights for a classy decoration of facades.

Step 4 Choose your light color

Warm white Plus+ (2400K)

Very warm light for pleasant atmosphere. Popular to use for a.o. bars, restaurants and hotels and to emphasize wooden buildings or event areas.

Warm white (3000K)

Pleasant warm light, suitable for hotels, shopping malls, passages, to emphasize buildings, event areas, shops.

Cold white (6500K)

Similar to daylight. Suitable for ice bars, events and to emphasize concrete buildings and shops.

Step 5 Choose your components

Making light curtains

To make light curtains you need to find the right combination of main cables and light strings to get the result you are looking for. This is what you do:



Calculate cable quantity for desired curtain width

Establish the required width of your light curtain(s) and calculate how many main cables in which size you need to reach it. A light curtain is nothing more than the combination of main cables and light strings. 36V main cables are available in 1,2, 2,4 or 4 meter and are connectable, using 2 or 5 meter extension cables to achieve the desired width.



Determine type and quantity of light strings for the right length

Based on the desired drop-down length and a choice between 3, 6 or 10 meter light strings light strings, you can determine how many light strings you need in which size. You can make dropdowns of 6, 10, 12, 16, 20 meter strings and so on.

Example: if you need a string with 26 meter length, you take two 10 meter connectable strings and connect them with a 6 meter string, using an end cap to finish. Decide how many 'finished' strings you need for your main cables (containing 12 or 24 sockets) that can hold an equal number of finished strings (1 string per socket).

Choosing additional lighting components

- Decide if and where you need to integrate Icicle light to decorate facades or balconies (see P30-31).

Choose the accessories you need for your light design

Walk through your light design and select the the power cables and accessories you need (see end of chapter). Make sure you don't forget to order extra power when required, or e.g. a 2-way or 5-way divider to connect more strings on one feed.

Step 6 Connect all components and assemble

Make sure to close off any un-used (free) connections with an end cap.

Good luck with your design and enjoy the result!



Need assistance?

We are happy to help you out so please don't hesitate to contact us.

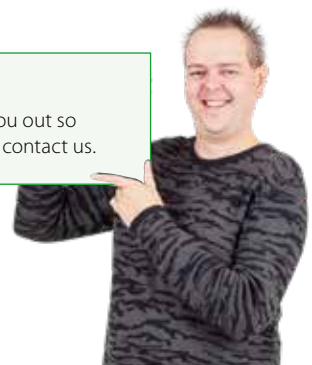

Main Cables | Pro System Modular 36V

MAIN CABLES FOR 36V LIGHT STRINGS

Connectable main cables for light curtains



- The first step is to determine the cable colors of your system. Tronix offers choice between a transparent or black rubber cable.
- Then determine the quantity and size of the main cables you would need to reach the desired width for your light curtain.

Input voltage: 36V

Length: 120, 240 or 400 cm

IP rate: IP65

Material: PVC

MAIN CABLE 36V - 1,2 METER



MAIN CABLE 36V - 2,4 METER



MAIN CABLE - BLACK



36V Modular Lighting System
 Need to light a public area? Check out the possibilities with our 36V Modular Lighting System!

Create your light design with the safe, low voltage lighting components of Pro System Modular 36V. With transparent, black or white wire and choice between Warm White (3000K), Warm white+ (2400K) or Cold White (6500K)

ART. NR.	DESCRIPTION	LENGTH	COLOR	SOCKETS	SOCKET DISTANCE	CARTON QUANTITY
018-050	PS36 Main Cable	120 cm	○ Transparent	12	10 cm	25
018-052	PS36 Main Cable	240 cm	○ Transparent	24	10 cm	10
018-036	NEW PS36 Main Cable	400 cm	● Black	10	40 cm	10

Pro System Modular 36V | Connectable Strings

CONNECTABLE LIGHT STRINGS - 10M

Compose your 36V light curtain with our selection of connectable light strings.



- Input voltage:** 36V
- Power:** 6,8 Watt
- Length:** 10 meter
- Nr. of strings:** 1
- Led's per string:** 100
- IP rate:** IP65
- LED distance:** 10 cm
- Material:** PVC (transparent)
- Connectable:** Yes
- Power supply:** not included
- End caps:** included
- Carton quantity:** 10



ART. NR.	LENGTH	WIRE COLOR	LIGHT COLOR	COLOR TEMP. (CCT)	LED'S P/STRING
018-138	10 meter	Transparent	○ Warm white	3000K	100
018-139	10 meter	Transparent	○ Warm white+	2400K	100

Led Power Supply for 36V light curtains | IP65



ART. NR.	POWER SUPPLIES FOR 36V STRINGS
018-004	PS36 LED Power Supply 15 Watt
018-005	PS36 LED Power Supply 30 Watt
018-001	PS36 LED Power Supply 60 Watt
018-002	PS36 LED Power Supply 100 Watt
018-003	PS36 LED Power Supply 200 Watt

PRO SYSTEM MODULAR

Tronix Pro System Modular: a range of IP44 and IP65 components, giving you the flexibility to make your own customized product. With a long durability, user friendliness and maximum light results:

Features

- IP65 - Transparent
- IP44 - Black & White (connection same as transparent)
- Round Led
- Advanced material composition for a long life span and easy to use

Connectable Strings | Pro System Modular 36V

CONNECTABLE LIGHT STRINGS - 6M

Compose your 36V light curtain with our selection of connectable light strings. Power supply not included.



- Input voltage:** 36V
- Power:** 4,6 Watt
- Length:** 6 meter
- Nr. of strings:** 1
- Led's per string:** 60
- IP rate:** IP65
- LED distance:** 10 cm
- Material:** PVC (transparent)
- Connectable:** Yes
- Power supply:** not included
- End caps:** included
- Carton quantity:** 18



ART. NR.	LENGTH	WIRE COLOR	LIGHT COLOR	COLOR TEMP. (CCT)	LED'S P/STRING
018-118	6 meter	Transparent	○ Warm white	3000K	60
018-119	6 meter	Transparent	○ Warm white+	2400K	60



Calculation example 1: For a 12 meter 2400K light curtain (white wire) with 12 meter drop-down:

Main cable - Transparent - 240cm	Art. nr. 018-052	5 pcs	120 sockets
Light string 6m Transparent wire - 2400K - 60 Led's p/string	Art. nr. 018-119	240 pcs	14.400 led's

Total amount of Led's to empower: 120 strings à 120 led's p/string = 14.400 Led's

To realize this you need: 4 x Power Supply 200W | Art. nr. 018-003

Calculation example 2: For a 40 meter Icicle Light in 2400K with 40cm dropdown

Iciclelight 36V - Warm White+ 2400K - 2m x 40 cm	Art. nr. 018-209	20 pcs
--	------------------	--------

Total amount of Led's to empower: 20 x 92 led's per set = 1.840 Led's.

To realize this you need: 1 x power supply 100W | Art. nr. 018-002

Pro System Modular 36V | Icicle Lights

ICICLE LIGHT 36V | 2M X 0,4M | CONNECTABLE

For horizontal applications, to use standalone or between main cables.
Power supply not included.

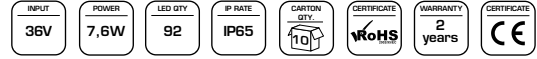

- Input voltage:** 36V
- Power:** 7,6 Watt
- Length:** 200 x 40 cm
- IP rate:** IP65
- Connectable:** Yes
- Power supply:** not included
- Nr. of strings:** 20
- Led's per string:** 3-5-7
- Led's total per set:** 92
- Material:** PVC (transparent)
- Carton quantity:** 10

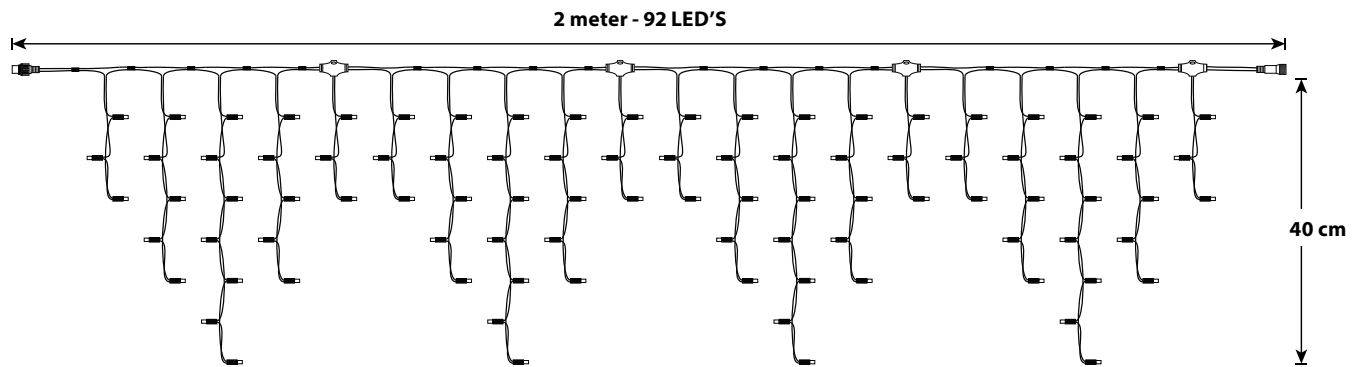

• MALE AND FEMALE CONNECTOR
• 20 STRINGS TOTAL - 92 LED'S

ART. NR.	LENGTH	WIRE COLOR	LIGHT COLOR	COLOR TEMP. (CCT)	LED'S
018-208	200 x 40 cm	Transparent	○ Warm White	3000K	92
018-209	200 x 40 cm	Transparent	○ Warm White+	2400K	92

Icicle Lights | Pro System Modular 36V

ICICLE LIGHT 36V | 2M X 0,8M | CONNECTABLE

For horizontal applications, to use standalone or between main cables.
Power supply not included.

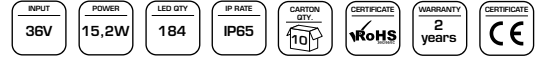

- Input voltage:** 36V
- Power:** 15,2 Watt
- Length:** 200 x 80 cm
- IP rate:** IP65
- Connectable:** Yes
- Power supply:** not included
- Nr. of strings:** 20
- Led's per string:** 6-10-14
- Led's total per set:** 184
- Material:** PVC (transparent)
- Carton quantity:** 10

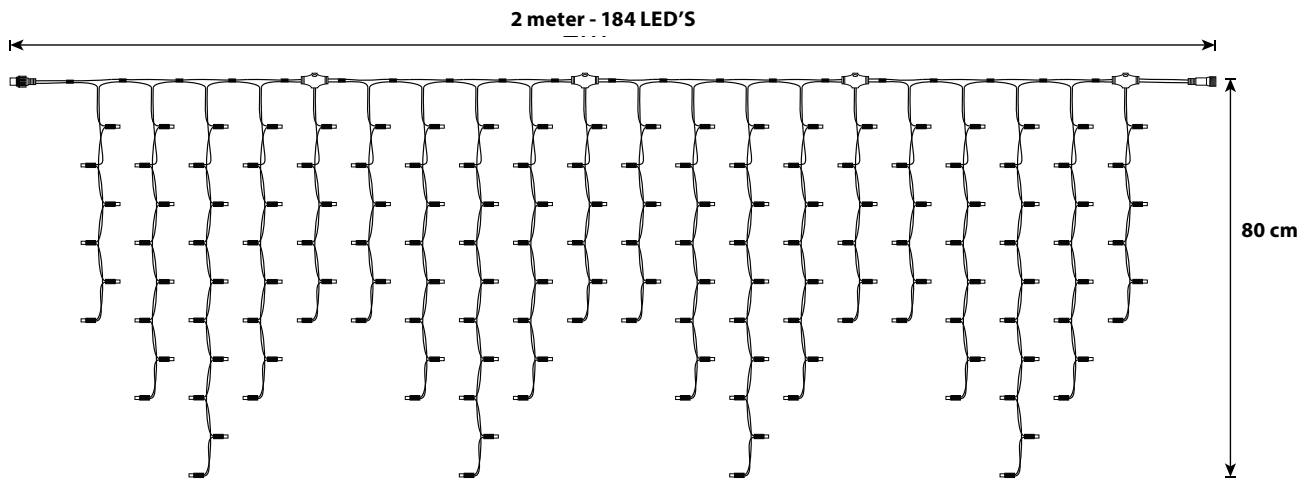
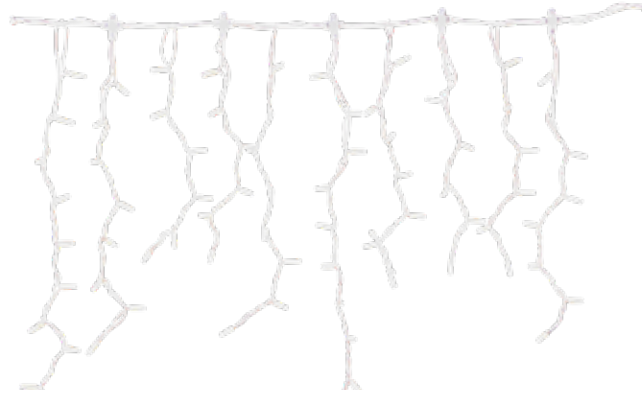

• MALE AND FEMALE CONNECTOR
• 20 STRINGS TOTAL - 184 LED'S

ART. NR.	LENGTH	WIRE COLOR	LIGHT COLOR	COLOR TEMP. (CCT)	LED'S
018-218	200 x 80 cm	Transparent	☉ Warm white	3000K	184
018-219	200 x 80 cm	Transparent	○ Warm white+	2400K	184



LED Icicle lights: for eye catching decors all year round

Led Icicle lights create a magical decor at any time of the year, not only at Christmas! There are lots of other ways to use these versatile lights all year round.

They have a professional look that adds beauty to any lighting display. Since they are shaped like icicles, LED icicle lights look great decorating the eaves of buildings where actual icicles commonly are found. These dangling LED lights are also perfect hanging from mantles, deck railings, gutters, fences, and more. Just use your imagination and you'll come up with many ideas to use them all year long.

Pro System Modular 36V | Connectable Strings

CONNECTABLE LIGHT STRINGS - 10M

Compose your 36V light curtain with our selection of connectable light strings.

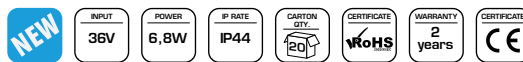

proSYSTEM
MODULAR LED 36V

- Input voltage:** 36V
- Power:** 6,8 Watt
- Length:** 10 meter
- Nr. of strings:** 1
- Led's per string:** 100
- IP rate:** IP44
- LED distance:** 10 cm
- Material:** PVC
- Connectable:** Yes
- Power supply:** not included
- End caps:** included
- Carton quantity:** 20



ART. NR.	WIRE COLOR	LIGHT COLOR	COLOR TEMP. (CCT)	LED'S P/STRING
018-520	● Black	○ Cold white	6500K	100
018-521	● Black	○ Warm white	3000K	100
018-522	● Black	○ Warm white+	2400K	100
018-560	○ White	○ Cold white	6500K	100
018-561	○ White	○ Warm white	3000K	100
018-562	○ White	○ Warm white+	2400K	100

NEW PRO SYSTEM MODULAR 2.0

Tronix Pro System Modular 2.0: Two new colors added at the existing transparent 36V Pro system line, an extended range of existing products but with even more design options.

2.0 features

- IP44
- Flat (instead of round) Led
- With even thinner wiring than our 36V Transparent and 230V Black & White products, this one stands out on flexibility without compromising on quality.

IP44

Connectable Strings | Pro System Modular 36V

CONNECTABLE LIGHT STRINGS - 3M

Compose your 36V light curtain with our selection of connectable light strings. Power supply not included.

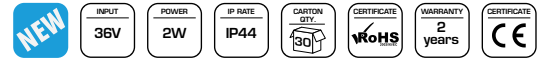

- Input voltage:** 36V
- Power:** 2 Watt
- Length:** 3 meter
- Nr. of strings:** 1
- Led's per string:** 30
- IP rate:** IP44
- LED distance:** 10 cm
- Material:** PVC
- Connectable:** Yes
- Power supply:** not included
- End caps:** included
- Carton quantity:** 30



ART. NR.	WIRE COLOR	LIGHT COLOR	COLOR TEMP. (CCT)	LED'S P/STRING
018-500	● Black	○ Cold white	6500K	30
018-501	● Black	○ Warm white	3000K	30
018-502	● Black	○ Warm white+	2400K	30
018-540	○ White	○ Cold white	6500K	30
018-541	○ White	○ Warm white	3000K	30
018-542	○ White	○ Warm white+	2400K	30



Calculation example 1: For a 12 meter 2400K light curtain (black wire) with 3 meter drop-down:

Main cable - Black - 400cm	Art. nr. 018-036	3 pcs	30 sockets
Light string 3m Black wire - 2400K - 30 Led's p/string	Art. nr. 018-502	30 pcs	900 led's

Total amount of Led's to empower: 30 strings à 30 led's p/string = 900 Led's
To realize this you need: 1 x Power Supply 60W | Art. nr. 018-001

Calculation example 2: For a 120 meter light string in 2400K

Light string 36V - Warm White+ 2400K - 10 m	Art. nr. 018-522	15 pcs
---	------------------	--------

Total amount of Led's to empower: 15 x 100 led's per set = 1,500 Led's.
To realize this you need: 1 x power supply 100W | Art. nr. 018-002



A



B



C



D



E



F



G



H



I



J



K

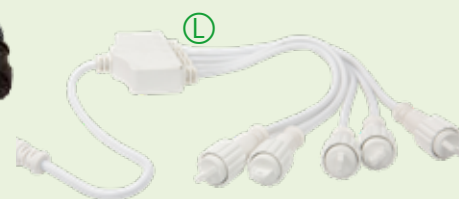

L

ART. NR.	EXTENSION CABLE TRANSPARANT 2M - 5M
A 018-014	○ Extension Cable - 2 meter
A 018-015	○ Extension Cable - 5 meter

ART. NR.	EXTENSION CABLE BLACK 2M - 5M
B 018-034 NEW	● Extension Cable - 2 meter
B 018-035 NEW	● Extension Cable - 5 meter

ART. NR.	EXTENSION CABLE WHITE 2M - 5M
C 018-024 NEW	○ Extension Cable - 2 meter
C 018-025 NEW	○ Extension Cable - 5 meter

ART. NR.	END CAP
D 018-011	○ Transparant End Cap
E 018-031 NEW	● Black End Cap
F 018-021 NEW	○ White End Cap

ART. NR.	2-WAY DIVIDER
G 018-012	○ Transparant 2-Way Divider
H 018-032 NEW	● Black 2-Way Divider
I 018-022 NEW	○ White 2-Way Divider

ART. NR.	5-WAY DIVIDER
J 018-013	○ Transparant 5-Way Divider
K 018-033 NEW	● Black 5-Way Divider
L 018-023 NEW	○ White 5-Way Divider

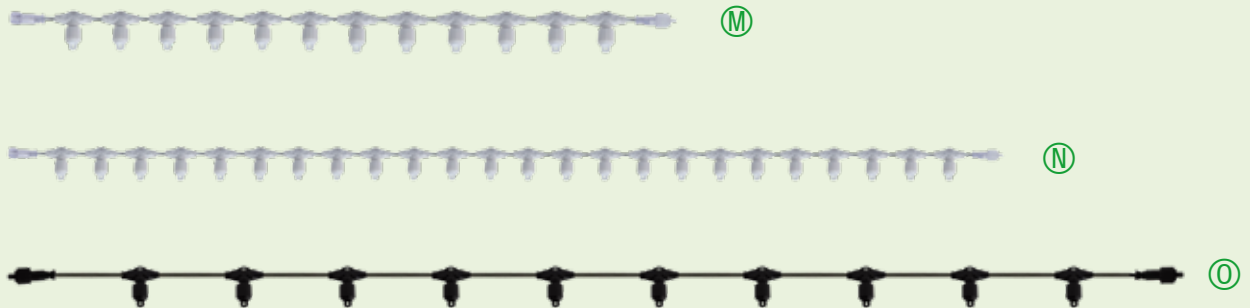

ART. NR.	5MAIN CABLES 120-400 CM
(M) 018-050	○ Transparant Main Cable 120 cm 12 sockets
(N) 018-052	○ Transparant Main cable 240 cm 24 sockets
(O) 018-036	NEW ● Black Main Cable 400 cm 10 sockets

ART. NR.	5POWER SUPPLIES FOR 36V STRINGS
(P) 018-004	NEW PS36 LED Power Supply 15 Watt 30M or 300 LEDS
(Q) 018-005	NEW PS36 LED Power Supply 30 Watt 60M or 600 LEDS
(R) 018-001	PS36 LED Power Supply 60 Watt 120M or 1200 LEDS
(S) 018-002	PS36 LED Power Supply 100 Watt 200M or 2000 LEDS
(T) 018-003	PS36 LED Power Supply 200 Watt 400M or 4000 LEDS

LED Tree Lighting 24/36V

The ultimate bringer of great and safe ambiance in streets, public places and gardens

Wanting shopping streets, squares and gardens to look extra attractive? And is safety important? Decorating them with low voltage Tronix Tree Light is your answer.

From small to big trees and from cone to crown shaped trees, our product offering in Tree Lighting offers a wide range of possibilities. Following the contours of the tree and its branches, the results are always amazing.

When it comes to decorating your tree(s) in a safe, efficient and most beautiful way, Tronix offers three Tree Lighting product groups to meet your demands.

Tronix Led's have a transparent housing which creates a beautiful "all around" appearance. The lights can be interchanged, when one is broken, the other lights will keep working. The tree lighting are powered by a transformer that is fixed at the bottom of the crown of the tree. The transformer is suitable for outdoor use and can easily be removed after the season.

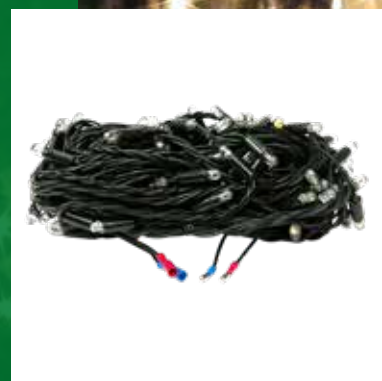
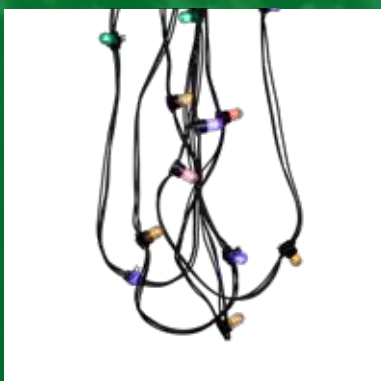



NEW

36V Tree Lighting for safe
ambiance in public places
and gardens

The new 36V Tree Light Pro integrates with Pro System Modular 36V, offering even more choice when it comes to creating your own safe light design. Available in Warm White 3000K, Warm White+ (2400K) or Cold White (6500K), and 4, 10 or 21 meters.

Tree Lighting | Light Design Tool

CONE-SHAPED TREES | GUIDELINES FOR DECORATING

Decoration basic

Decoration normal

Decoration intense

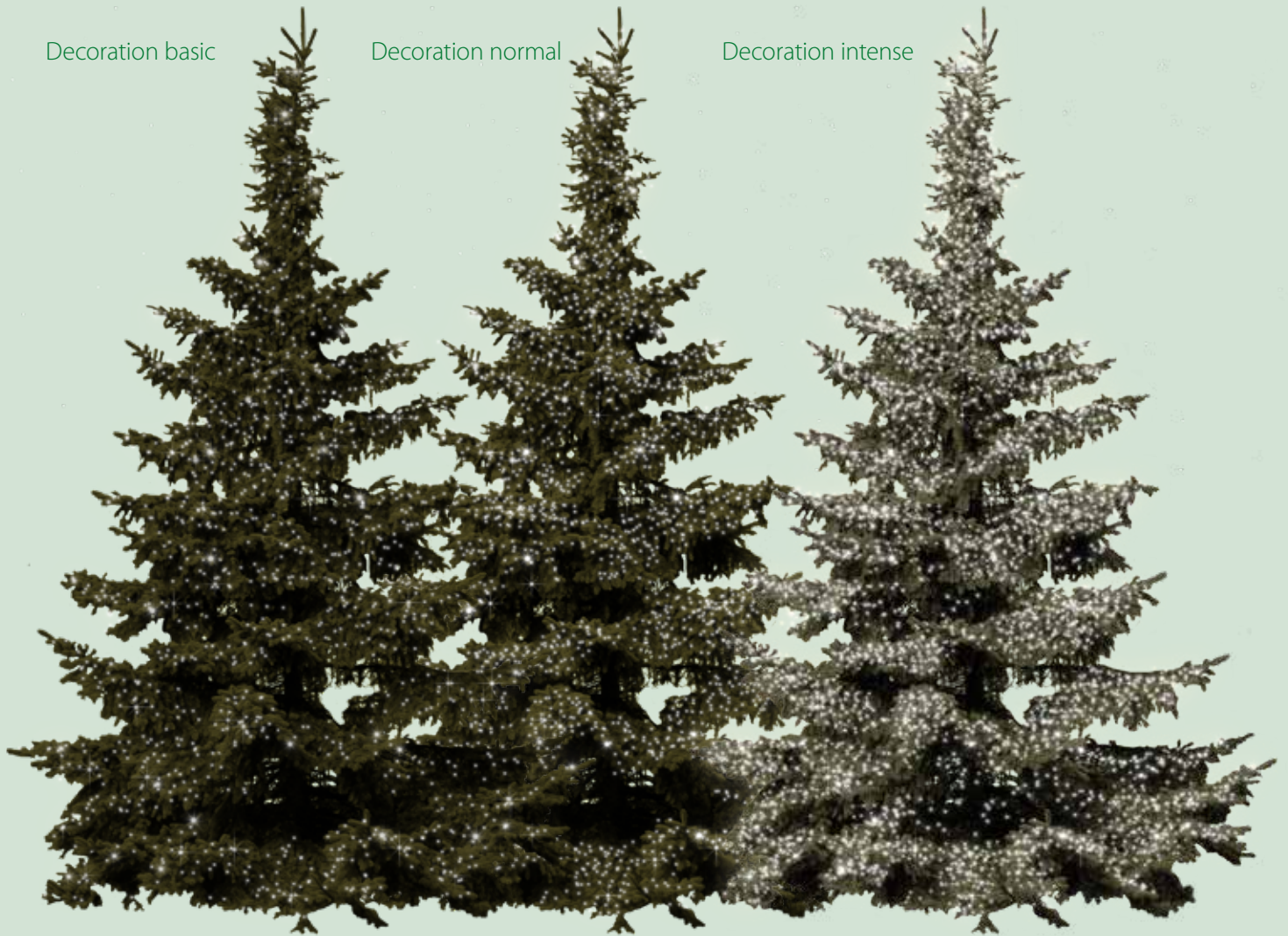

TREE HEIGHT [M]	DECORATION BASIC [M]	DECORATION NORMAL [M]	DECORATION INTENSE [M]
Cone shaped tree 1,5m	6	8	11
Cone shaped tree 2m	11	16	21
Cone shaped tree 2,5m	18	26	35
Cone shaped tree 3m	27	40	53
Cone shaped tree 4m	51	77	102
Cone shaped tree 5m	85	128	170
Cone shaped tree 6m	130	194	259
Cone shaped tree 7m	184	276	368
Cone shaped tree 8m	251	376	501
Cone shaped tree 9m	328	492	656
Cone shaped tree 10m	418	627	836
Cone shaped tree 12,5m	699	1048	1397
Cone shaped tree 15m	1062	1593	2124
Cone shaped tree 20m	2058	3087	4116

* These figures are only indicative and very dependent on the growth of the tree

CROWN-SHAPED TREES | GUIDELINES FOR DECORATING

Decoration basic

Decoration intense



TREE CROWN Ø [M]	DECORATION BASIC [M]	DECORATION NORMAL [M]	DECORATION INTENSE [M]
Crown shaped tree 1m	5	8	10
Crown shaped tree 1,2	8	12	15
Crown shaped tree 1,5m	13	19	25
Crown shaped tree 2m	23	35	46
Crown shaped tree 2,5m	38	57	76
Crown shaped tree 3m	57	85	113
Crown shaped tree 4m	106	159	212
Crown shaped tree 5m	173	259	345
Crown shaped tree 6m	258	387	516
Crown shaped tree 7m	362	543	724
Crown shaped tree 8m	486	728	971
Crown shaped tree 9m	629	943	1257
Crown shaped tree 10m	793	1189	1585
Crown shaped tree 15m	1934	2901	3868

* These figures are only indicative and very dependent on the growth of the tree

Tree Lighting 24V | Easy decoration of larger trees

On the next few pages you can use our light design tool to help you determine the light string quantity for any size tree. The String Light Pro is a 63M low voltage and connectable light string to decorate any larger tree.

SEE P41/42 TO DISCOVER OUR FULL RANGE OF REGULAR OR IN-LINE STRING LIGHT

Here's a few tips & tricks from a tree light professional to help you use and install Tronix String Light Pro in a such a way that best results in decorative effects and product sustainability are guaranteed.

2 ways to mount String Light Pro:

1. Rotated around the branch

One way is to rotated around a branch, whereby the lighting must be rotated loosely around the branch. If it is too tight, the tree can pull the lighting apart as it grows.

2. Upright mounting following the branch

Another way is to tie the light string neatly to the tree branch in an upright position, using our rubber tie tubes (Art.Nr. 535-090) to keep the wire in place. This method will have a "neater" appearance because the lighting is mounted In-Line with the branch.

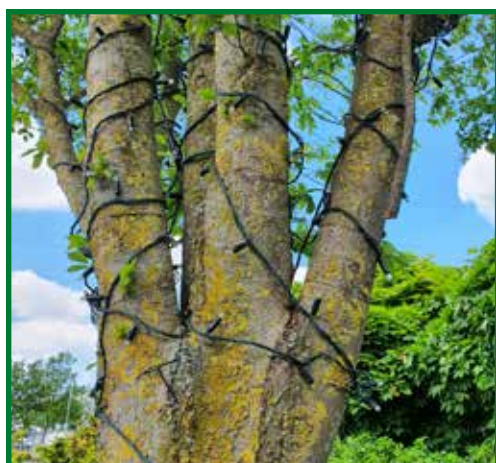

1 Loosely rotated around the branch



2 Mounted in upright position following the branch



Placing the driver in the crown of the tree is the safest solution (e.g. in public areas)



Using elastic tie tube Art. nr. 535-090 to tie strings together or attach them to the branch

Important to know

- With fast growing trees, such as plane trees or young trees, it is important to check after 1 or 2 years if there still is enough space between the wire and the branch.
- Approximate time that the lighting can remain in the tree is about 5 years (due to natural growth or trimming)
- It is recommendable to hire a professional to install your tree lighting. To make sure it happens in the best possible way. They have the expertise and often dispose of reach trucks.
- Wires can be tied together with Tronix connectors Art. nr. 595-030/595-031 or by using Tronix dividers Art. nr. 535-005 or 535-020.

Check P41 for an overview of all available String Light Pro 24V accessories

Don't forget

- 1 To always leave enough room between the wire and the branch
- 2 To use Tronix elastic tie tube for tight results and best protection of the tree
- 3 Only to use cheap tie wraps for loose wrapping or short term use
- 4 Not to pull the light strings over edges or sharp parts during (dis)assembly
- 5 For best protection against moisture, always mount connectors in an upright position



? Need help or advice?

Don't hesitate to contact us, we are glad to be of assistance.

String Light Modular 24V | Tree Lighting

TREE LIGHT PROFESSIONAL 24V | 63M | REGULAR

63 meter tree light string with 420 Led's for decorating larger trees.

Regular version with vertically positioned side branche.



- Input voltage:** 24V
- Power:** 25 Watt
- Led quantity:** 420
- Led distance:** 15 cm
- Connectable:** Yes (max. 63 meter in one line)
- Power supply:** Not included
- Cutting distance:** 90 cm
- IP rate:** IP65
- Wire color:** Green
- Carton quantity:** 8



ART. NR.	WIRE COLOR	LIGHT COLOR	CCT	LED QTY
025-021	● Green	○ Cold white	6500K	420
025-018	● Green	○ Warm white	3000K	420
025-019	● Green	○ Warm white+	2400K	420

ACCESSORIES FOR TREE LIGHT PROFESSIONAL 24V



2-WAY DIVIDER (5 PCS)
Art. nr. 535-005



5-WAY DIVIDER (2 PCS)
Art. nr. 535-020



EXTENSION CABLE 4M (2 PC)
Art. nr. 535-025



AMP DIVIDER
Art.nr. 535-050 (2,3mm/100pcs)
Art.nr. 535-051 (4,2mm/25pcs)



ELASTIC TIE TUBE 50M
to protect tree branches
Art. nr. 535-090



CONNECTOR FEMALE - BAG 100 PCS.
Art. nr. 535-032 (Red)
Art. nr. 535-033 (Blue)



CONNECTOR MALE BAG 100 PCS.
Art. nr. 535-030 (Red)
Art. nr. 535-031 (Blue)



POWER SUPPLY 24V | 30W
Art. nr. 215-300



POWER SUPPLY 24V | 60W
Art. nr. 215-301



POWER SUPPLY 24V | 30W
Art. nr. 215-302



POWER SUPPLY 24V | 200W
Art.nr. 215-318

ART. NR.	POWER SUPPLIES 24V	SIZE L X W X H	WIRE LENGTH IN OUT	CONNECTION TYPE
215-300	Power supply 24V IP67 30 Watt	165 x 30 x 20 mm	100 cm 100 cm	Shuko Power plug
215-301	Power supply 24V IP67 60 Watt	165 x 40 x 30 mm	100 cm 100 cm	Shuko Power Plug
215-302	Power supply 24V IP67 100 Watt	180 x 50 x 35 mm	100 cm 100 cm	Shuko Power Plug
215-318	Power supply 24V IP67 200 Watt	225 x 70 x 40 mm	26,5 cm 25 cm	Stripped wire

Tree Lighting | String Light Pro 36V

STRING LIGHT PROFESSIONAL 36V | 4M

4 meter tree light string for decorating small to larger trees.

With male & female connector

Input voltage: 36V

Power: 1,5 Watt

Led quantity: 30

Led distance: 15 cm

Connectable: Yes (max. 63 meter in one line)

Power supply: Not included

Cutting distance: 150 cm

IP rate: IP65

Wire color: Green

Carton quantity: 10

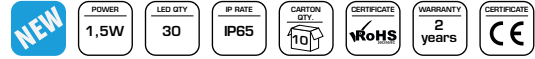

ART. NR.	WIRE COLOR	LIGHT COLOR	CCT	LED QTY
025-141	● Green	○ Cold white	6500K	30
025-138	● Green	○ Warm white	3000K	30
025-139	● Green	○ Warm white+	2400K	30

STRING LIGHT PROFESSIONAL 36V | 10M

10 meter tree light string for decorating small to larger trees.

With male & female connector

Input voltage: 36V

Power: 3 Watt

Led quantity: 70

Led distance: 15 cm

Connectable: Yes (max. 63 meter in one line)

Power supply: Not included

Cutting distance: 150 cm

IP rate: IP65

Wire color: Green

Carton quantity: 20

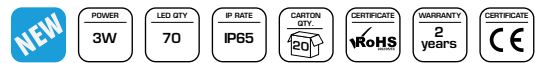

ART. NR.	WIRE COLOR	LIGHT COLOR	CCT	LED QTY
025-131	● Green	○ Cold white	6500K	70
025-128	● Green	○ Warm white	3000K	70
025-129	● Green	○ Warm white+	2400K	70

LOW VOLTAGE MODULAR STRING LIGHT 4/10/21M

Create your own design

- Safe low voltage, ideal for public places
- Connectable at two sides (in and out)
- Easy to use
- Choice in length & color for custom-made light designs

String Light Pro 36V | Tree Lighting

STRING LIGHT PROFESSIONAL 36V | 21M

21 meter tree light string for decorating small to larger trees.

With male & female connector

Input voltage: 36V

Power: 6 Watt

Led quantity: 140

Led distance: 15 cm

Connectable: Yes (max. 63 meter in one line)

Power supply: Not included

Cutting distance: 150 cm

IP rate: IP65

Wire color: Green

Carton quantity: 10

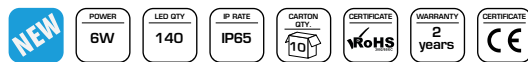

ART. NR.	WIRE COLOR	LIGHT COLOR	CCT	LED QTY
025-121	● Green	○ Cold white	6500K	140
025-118	● Green	○ Warm white	3000K	140
025-119	● Green	○ Warm white+	2400K	140

ACCESSORIES FOR TREE LIGHT PROFESSIONAL 36V



2-WAY DIVIDER
Art. nr. 018-032



5-WAY DIVIDER
Art. nr. 018-033



EXTENSION CABLE 2M
Art. nr. 018-034



EXTENSION CABLE 5M
Art. nr. 018-035



ELASTIC TIE TUBE 50M
to protect tree branches
Art. nr. 535-090



MAIN CABLE 4M | 10 SOCKETS
For vertical hanging light strings
Art. nr. 018-036



END CAP
Art. nr. 018-031



POWER SUPPLY 36V | 15W
Art. nr. 018-004



POWER SUPPLY 36V | 30W
Art. nr. 018-005



POWER SUPPLY 36V | 60W
Art. nr. 018-001



POWER SUPPLY 36V | 100W
Art. nr. 018-002



POWER SUPPLY 36V | 200W
Art. nr. 018-003

ART. NR.	POWER SUPPLIES 36V	SIZE L X W X H	CONNECTION TYPE	MAX. CONNECT
018-004	Power supply 36V IP67 15 Watt	109 x 30 x 20 mm	Schuko ungrounded	30M or 300 Leds
018-005	Power supply 36V IP67 30 Watt	182 x 30 x 20 mm	Schuko ungrounded	60M or 600 Leds
018-001	Power supply 36V IP67 60 Watt	160 x 50 x 35 mm	Schuko ungrounded	120M or 1200 Leds
018-002	Power supply 36V IP67 100 Watt	180 x 50 x 35 mm	Schuko ungrounded	200M or 2000 Leds
018-003	Power supply 36V IP67 200 Watt	205 x 75 x 45 mm	Schuko ungrounded	400M or 4000 Leds

Tree Lighting | Tips & Tricks

DECORATING TREES: TIPS & TRICKS

When decorating trees with lights, there are some basic measurements that you need to take into account, such as size and diameter of the tree trunk as well as the branches you wish to decorate. Other considerations are the intensity of light decoration - influenced by light string quantity and led distance. On the next few pages you can use our light design tool to help you determine the light string quantity for any size tree.

Trees are often decorated incorrectly in terms of working method and applying the String Light in the most suitable manner.

Tips & Tricks:

Work from the down side of the tree branch

When applying the light strings onto/around the tree, keep in mind that for the viewers on the ground, the lights will be best visible when applied on the down (not the upper side) of the tree branch. This often goes wrong because from an installer's point of view, standing on a platform of a height worker, they will do the exact opposite.

Don't wrap the wire but make it follow the branches

When aiming to leave the lights in the tree for a longer period of time, make sure to apply the wire in the correct way: following the branch in a straight line instead of being (too tightly) winded around the tree. See also the illustration below. Select the desired light color of the light strings and other product components.



Important

Don't:

Never wind the wire around the branch like is done in the picture below. The branch will grow or sometimes even expand because of temperature changes. As you can see, the wire will be tightened around the branch as a result, causing it to break or be damaged.

Do:

Better lead the wire in line with the branch and use a rubber tie tube (Art. nr. 535-090) to keep the wire in place. Plastic tie-wraps are only suitable for short term use as they will eventually bring harm to the tree.



To connect 2 String Lights:

- 1 Screw on the connection part at the end of the plug
- 2 Open the connection part, put the plug cable away
- 3 Screw on the end cap
- 4 Pull out the sealing plug
- 5 Connect the two strings to each other
- 6 Screw on the connection part.



LED efficiency and possibilities

Over the last few years, LED development has finally conquered the area of Christmas lighting. Slowly the world has started to realize that modern Led technology has been opening a lot of doors in terms of color shades and versatility in application. On top of Led's having an extremely low energy consumption and a much longer life of course.



High quality for solid results and durability

The outer light chains are designed in a very robust and excellent quality. The LEDs are sealed towards the cable and covered with a protective tube. The cables are made of rubber or a PVC alloy that is resistant to UV radiation. In addition, the wire is IP65 water resistant. Following a safe working method ensures a long lifespan of Tronix String Light.

Important:

Make sure not to pull the light strings over edges or sharp parts during assembly and disassembly. This may cause damage to the wire.



? Need help or advice? Don't hesitate to contact us. we are glad to be of assistance.



Decorated tree with 2400K Tree Light Pro Light strings - ID Light Nistelrode, the Netherlands

Tree Lighting | Belt Light

BELT LIGHT | 230V | 10M | INDOOR & OUTDOOR

Available in Warm white+, Warm white or Multicolor (red, yellow, blue, green, white).
Connectable up to 10 pcs, including Schuko power cable 010-013.

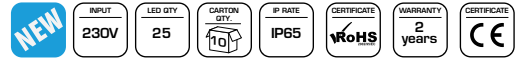

Input voltage: 230V

Connectable: Yes

Dimmable: Yes, triac

IP rate: IP65

Wire color: Black

Light color: Warm White+, Warm White or Multicolor (steady)

Power cable: 150 cm Schuko Power Cable included

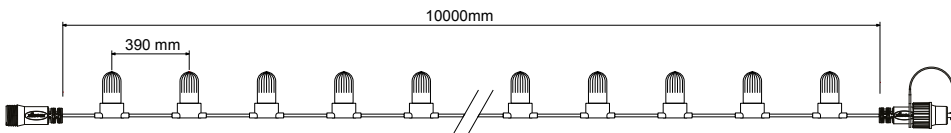

ART. NR.	INPUT	WIRE COLOR	POWER	LIGHT COLOR	LED QTY	MAX. TO CONNECT	CARTON QUANTITY
024-078	230V	● Black (Rubber)	4,6 Watt	○ Warm white 3000K	25	10 Belt Lights (1 power cable)	10
024-079	230V	● Black (Rubber)	4,6 Watt	○ Warm White+ 2400K	25	10 Belt Lights (1 power cable)	10
024-070	230V	● Black (Rubber)	4,6 Watt	● Multicolor + white	25	10 Belt Lights (1 power cable)	10





RUBBER

BELT LIGHT: ALL YEAR ROUND APPLICABILITY

Belt Light can be used as a string light for trees in the Christmas season, but also as a festive, multi-functional Partylight during summer. Being fully connectable with Pro System Modular 230V, Tronix Belt Light can easily be integrated in your own creative light design.

Designed for flexibility

The Beltlight String has a rubber cable designed for flexibility and good resistance to all weather conditions. This type of material is easy to work with because it's highly flexible and therefore ideally suited for hang-up between two objects, or for easy tree decoration with single bulb hang-up attachments. With PVC, non-breakable bulbs.



Multicolor Belt Light

Web Light | Tree Lighting

WEB LIGHT | 24V OR 230V | INDOOR & OUTDOOR

Connectable (max. 20 sets)



Input voltage: 24V (including transformer) or 230V

Connectable: Yes

IP rate: IP65

Wire color: Green or Black (rubber)

Light color: Warm White

Power cable: 1,80 meter (included)

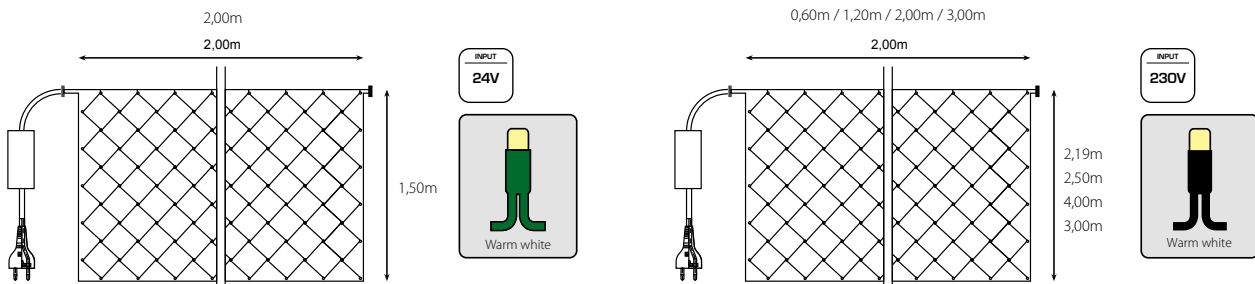

ART. NR. - 24V	INPUT	WIRE COLOR	POWER	LIGHT COLOR	SIZE	LED QTY	MAX. TO CONNECT	CARTON QUANTITY
033-008	24V	● Green (PVC)	17 Watt	○ Warm white 3200K	200 x 150 cm	156	8 sets	8
ART. NR. - 230V	INPUT	WIRE COLOR	POWER	LIGHT COLOR	SIZE	LED QTY	MAX. TO CONNECT	CARTON QUANTITY
033-028	230V	● Black (Rubber)	40 Watt	○ Warm white 3200K	250 x 120 cm	406	12 sets	4
033-038	230V	● Black (Rubber)	65 Watt	○ Warm White 3200K	400 x 200 cm	648	8 sets	2
033-048	230V	● Black (Rubber)	75 Watt	○ Warm White 3200K	300 x 300 cm	750	6 sets	1

ACCESSORIES FOR WEB LIGHT 230V

For LED Web Light Plug & Play accessories we refer to the available items as shown on P22-23 (picture C, D, J, K, N, O)



TRONIX WEB LIGHT FOR EASY WRAPPING OF TREE AND COLUMNS

Tronix Web Light with LED technology in 230V or 24V is very easy to use and will get you astonishing results with minimum effort. These easy to use web curtains can be wrapped around trees, bushes, columns or any other wrappable object. The regularity of the arranged LED's ensure a special effect, turning them into unique lighting projects. Stable rubber cables give this product a high level of safety and resistance to moisture and sun. With a protection rate IP65 this product is suitable for indoor and outdoor applications.

2D & 3D Motifs

Elegant designs for hanging, standing and laying down to suit any decorative purpose or personal taste.

Decorating a building, garden or public square doesn't stop at lighting trees, bushes and windows! Go for a finishing touch with our elegant 3D & 2D decorative motifs, such as Snowflakes, Comets or Stars that can easily be integrated with your light design for an ultimate wow-effect.

Our 3D decorative light balls are an absolute show-stopper and unique in appearance. Available in three sizes and two shades of white and an elegant flash, they are great to use in combination with any light string design, but can just as easily be laid flat on a roof for an elegant gesture. Positioning them randomly on the ground will give an instant winter wonderland effect, and placing them onto a big flower pot will turn into a piece of art.

Tronix 3D Star Cone Trees on the other hand, are perfect choice to enhance the entrance of your building, making visitors immediately feel at home. When placed on each side of the entrance they turn into an absolute eye-catcher.





Beautifully decorated Residential building with Tronix Motifs in different sizes - Uden, the Netherlands

3D Motifs



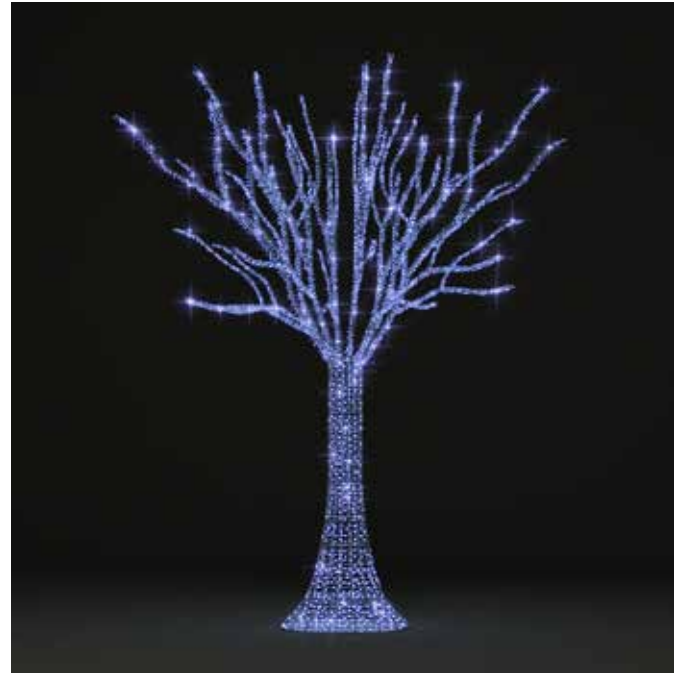

DESIGN YOUR OWN MOTIF

Are you searching for that one beautiful star or snowflake you saw somewhere in a decorated street? Do you need a specific size motif for your project? Ask us for the possibilities for custom-made 2D/3D decorative motif designs at sales@tronixlighting.com or T +31 (0) 413 -33 03 80

- Step 1:** Share your idea
- Step 2:** Receive drawing for approval
- Step 3:** Receive sample (adjustments)
- Step 4:** Approve sample
- Step 5:** Deliver end product

Leadtime : 8-10 weeks

3D Motifs | Connectable

3D LIGHT DECORATION BALLS BLACK OR WHITE | SMALL

Extra small (20cm) with in- and outgoing connection for integration in 230v decorative light curtains and designs. Power cable not included!

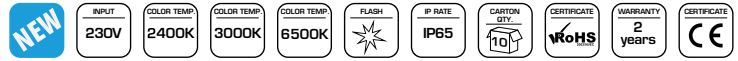

- Input voltage:** 230V
- Size:** Diameter 20 cm
- Wire color:** White or black
- Light color:** 2400K, 3000K or 6500K
- Connection plug:** Included (in/out)
- IP Rate:** IP65
- Power cable:** Not included
- Material:** Steel construction (white or black powder coated)
- Carton quantity:** 10



ART. NR.	SIZE	FRAME & WIRE COLOR	LIGHT COLOR	POWER	LED QTY (STEADY/FLASH)
571-061	Ø 20 cm x 20 cm	○ White	○ 6500K Cold white & flash	3,5 Watt	40 (34/6)
571-078	Ø 20 cm x 20 cm	● Black	○ 3000K Warm white & flash	3,5 Watt	40 (34/6)
571-079	Ø 20 cm x 20 cm	● Black	○ 2400K Extra warm white & flash	3,5 Watt	40 (34/6)

ACCESSORIES	ART. NR. WHITE	ART. NR. BLACK
Power cable - 1,5 meter Schuko (max. 6000 led's)	○ 010-012	● 010-013
Main cable XL - 5 meter	○ -	● 010-115
Extension cable - 0,5 meter	○ 010-200	● 010-201
Extension cable - 1 meter	○ 010-202	● 010-203
Extension cable - 2 meter	○ 010-204	● 010-205
Extension cable - 3 meter	○ 010-206	● 010-207
Extension cable - 5 meter	○ 010-208	● 010-209
Y-connector	○ 010-199	● 010-198

* For all Pro System Modular 230V accessories, see P 22-23.

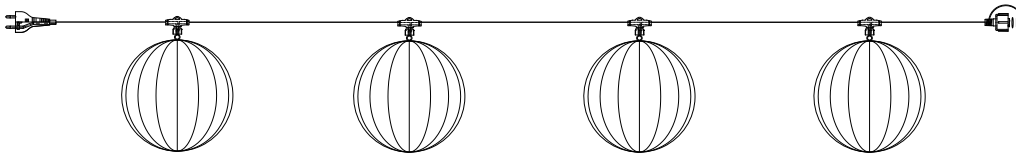
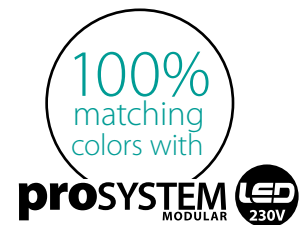

TIP:

Use a XL Main Cable 010-115 with Small 3D Motifs to decorate large Christmas trees.



APPLICATIONS WITH SMALL 3D BALLS

- Attach the small motif to a XL Main Cable and use them as a String Light to decorate big Christmas trees
- Use them in combination with other sizes 3D Balls for street light decoration
- Hang them from tree branches
- Decorate a winter event with motifs hanging from the ceiling
- Use them in combination with other 230V Pro System Modular items to create a custom-made design

Connectable & Foldable | 3D Motifs

3D LIGHT DECORATION BALLS BLACK OR WHITE | 3000K FLASH | FOLDABLE

In 3 sizes with in- and outgoing connection for integration in 230V decorative light curtains and designs. Power cable not included!

Foldable design for easy handling and transport

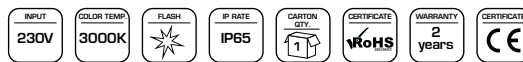

- Input voltage:** 230V
- Size:** Diameter 80 cm, 50 cm or 35 cm
- Wire color:** White or black
- Light color:** 3000K with flash
- Connection plug:** Included (in/out)
- IP Rate:** IP65
- Power cable:** Not included
- Material:** Steel construction (white or black powder coated)
- Carton quantity:** 1



ART. NR.	SIZE	FRAME & WIRE COLOR	LIGHT COLOR	POWER	LED QTY (STEADY/FLASH)
571-009	Ø 35 cm x 35 cm	○ White	○ 3000K Warm white & flash	6,5 Watt	84 (70/14)
571-010	Ø 35 cm x 35 cm	● Black	○ 3000K Warm white & flash	6,5 Watt	84 (70/14)
571-019	Ø 50 cm x 50 cm	○ White	○ 3000K Warm white & flash	10 Watt	189 (158/31)
571-020	Ø 50 cm x 50 cm	● Black	○ 3000K Warm white & flash	10 Watt	189 (158/31)
571-029	Ø 80 cm x 80 cm	○ White	○ 3000K Warm white & flash	20 Watt	336 (280/56)
571-030	Ø 80 cm x 80 cm	● Black	○ 3000K Warm white & flash	20 Watt	336 (280/56)

ACCESSORIES	ART. NR. WHITE	ART. NR. BLACK
Power cable - 1,5 meter Schuko (max. 6000 led's)	○ 010-012	● 010-013
Extension cable - 0,5 meter	○ 010-200	● 010-201
Extension cable - 1 meter	○ 010-202	● 010-203
Extension cable - 2 meter	○ 010-204	● 010-205
Extension cable - 3 meter	○ 010-206	● 010-207
Extension cable - 5 meter	○ 010-208	● 010-209
Y-connector	○ 010-199	● 010-198

* For all Pro System Modular 230V accessories, see P 22-23.

100%
matching
colors with



EXTENSION CABLE WHITE

5 sizes



POWER CABLE 1,5M

Art. nr. ○010-012 ●010-013

Y CONNECTOR

Art. nr. ○010-199 ●010-198



Tronix Decorative Light Balls are provided with 1 male plug for connecting the ball to the power cable, and 1 female plug to connect it to a set light strings or a light string curtain that might be hanging down from a window or is used to make a bridge from one side of a street or building to the other.

2D Motifs | Connectable

CRYSTAL SNOWFLAKE MOTIF | 60CM | CONNECTABLE

With sturdy aluminium frame and connection for easy integration with light curtains and designs.

Input voltage: 230V

Power: 13 Watt

Light color: Warm white + or Cold white

Color Temp. (CCT): 2400K or 6500K

LED quantity: 36 p/m

Dimension: 60 x 52 cm

Power Cable: not included

IP Rate: IP44

Carton quantity: 5

ART. NR.	LIGHT COLOR	COLOR TEMP. (CCT)	SIZE
580-020	Cold white	○ 6500K	60 x 52 cm
580-021	Warm white +	○ 2400K	60 x 52 cm



proSYSTEM MODULAR LED 230V



TWINKLE STAR MOTIF 8-POINT | 60CM | CONNECTABLE

With sturdy aluminium frame and connection for easy integration with light curtains and designs.

Input voltage: 230V

Power: 5,4 Watt

Light color: Warm white + or Cold white

Color Temp. (CCT): 2400K or 6500K

LED quantity: 36 p/m

Dimension: 60 x 60 cm

Power Cable: not included

IP Rate: IP44

Carton quantity: 5

ART. NR.	LIGHT COLOR	COLOR TEMP. (CCT)	SIZE
580-022	Cold white	○ 6500K	60 x 60 cm
580-023	Warm white +	○ 2400K	60 x 60 cm



proSYSTEM MODULAR LED 230V



TWINKLE STAR MOTIF 5-POINT | 60CM | CONNECTABLE

With sturdy aluminium frame and connection for easy integration with light curtains and designs.

Input voltage: 230V

Power: 6,7 Watt

Color: Warm white + or Cold white

Color Temp. (CCT): 2400K or 6500K

LED quantity: 36 p/m

Dimension: 60 x 57 cm

Power Cable: not included

IP Rate: IP44

Carton quantity: 5

ART. NR.	LIGHT COLOR	COLOR TEMP. (CCT)	SIZE
580-024	Cold white	○ 6500K	60 x 57 cm
580-025	Warm white +	○ 2400K	60 x 57 cm



proSYSTEM MODULAR LED 230V



CRYSTAL SNOWFLAKE MOTIF | NEON | CONNECTABLE

With sturdy aluminium frame and connection for easy integration with light curtains and designs.
Steel frame outlined with led neon rope light (no visible light dots).

- Input voltage:** 230V
- Power:** 10 Watt
- Light color:** Warm white
- Color Temp. (CCT):** 3000K
- LED quantity:** 162
- Dimension:** 50 x 43 cm
- Power Cable:** Not included
- IP Rate:** IP44
- Carton quantity:** 5

ART. NR.	LIGHT COLOR	COLOR TEMP. (CCT)	SIZE
580-032	Warm white	○ 3000K	50 x 43 cm



TWINKLE STAR MOTIF 8-POINT | NEON | CONNECTABLE

With sturdy aluminium frame and connection for easy integration with light curtains and designs.
Steel frame outlined with led neon rope light (no visible light dots).

- Input voltage:** 230V
- Power:** 6,7 Watt
- Light color:** Warm white
- Color Temp. (CCT):** 3000K
- LED quantity:** 120
- Dimension:** 50 x 43 cm
- Power Cable:** not included
- IP Rate:** IP44
- Carton quantity:** 5

ART. NR.	LIGHT COLOR	COLOR TEMP. (CCT)	SIZE
580-030	Warm white	○ 3000K	50 x 43 cm



INTEGRATE THESE MOTIFS IN PRO SYSTEM MODULAR 230V LIGHT DESIGNS

All models on this page have an easy connection plug for creative combinations with the products and light curtain possibilities as shown in the first chapter "Pro System Modular 230V". With the accessories shown on page 22-23 you can add motifs and make your personal light design complete.

Non-connectable | 2D Motifs

COMET 85 X 45CM | WW | NON-CONNECTABLE

Steel frame outlined with led rope light



Input voltage: 230V
Color: Warm white
Color Temp. (CCT): 3000K
Dimension: 85 x 45 cm
Power Cable: 1,50 Meter (included)
IP Rate: IP44
Carton quantity: 5



ART. NR.	LIGHT COLOR	COLOR TEMP. (CCT)	SIZE
570-010	Warm white	<input type="radio"/> 3000K	85 x 45 cm

STAR 53CM | WHITE | NON-CONNECTABLE

Steel frame outlined with led rope light



Input voltage: 230V
Color: White
Color Temp. (CCT): 5000K
Dimension: 53 x 53 cm
Power Cable: 1,50 Meter (included)
IP Rate: IP44
Carton quantity: 5



ART. NR.	LIGHT COLOR	COLOR TEMP. (CCT)	SIZE
570-026	Cold white	<input type="radio"/> 5000K	53 x 53 cm



APPLICATIONS WITH SNOWFLAKES

- Use them in combination with light strings for street light decoration
- Secure Snowflake motifs onto railings or alongside steps or stairways
- Position them upright on the top of a roof
- Attach snowflake to gates or fences
- Hang them from tree branches
- Decorate a winter event with snowflakes hanging from the ceiling or attached to walls

Cone Tree | 3D Motifs

LED STAR CONE TREE | 200 x Ø78 CM | GREEN CARPET

Standard green covering with steady white- & twinkling white led's. Built up in 1M segments.



Input voltage: 230V

Power: 84W

Dimension: 200 x Ø 78 cm (floor size)

Rope light: 26m

Led total stars: 1006 (26 m rope light)

Led total dots: 70 (50 steady, 20 twinkle)

IP Rate: IP44

Carton quantity: 1

ART. NR.	LIGHT COLOR	LED'S TOTAL	SIZE
580-069	Cold white	1006	200 x ø78 cm



HOW TO USE

Elegant beauty meets rugged durability with this LED Star cone tree. This tree can be used as a statement piece for a stunning christmas display, as centre piece on a square or as an elegant piece for your entrance. Sets up easily, ready to display either indoors or outdoors and built up in 1 m segments for easy storage.

Stars - With a total of 26M ropelight there are 1006 LED's (all steady)

Dots - In total this tree has 70 LED dots, 50 steady and 20 twinkle.

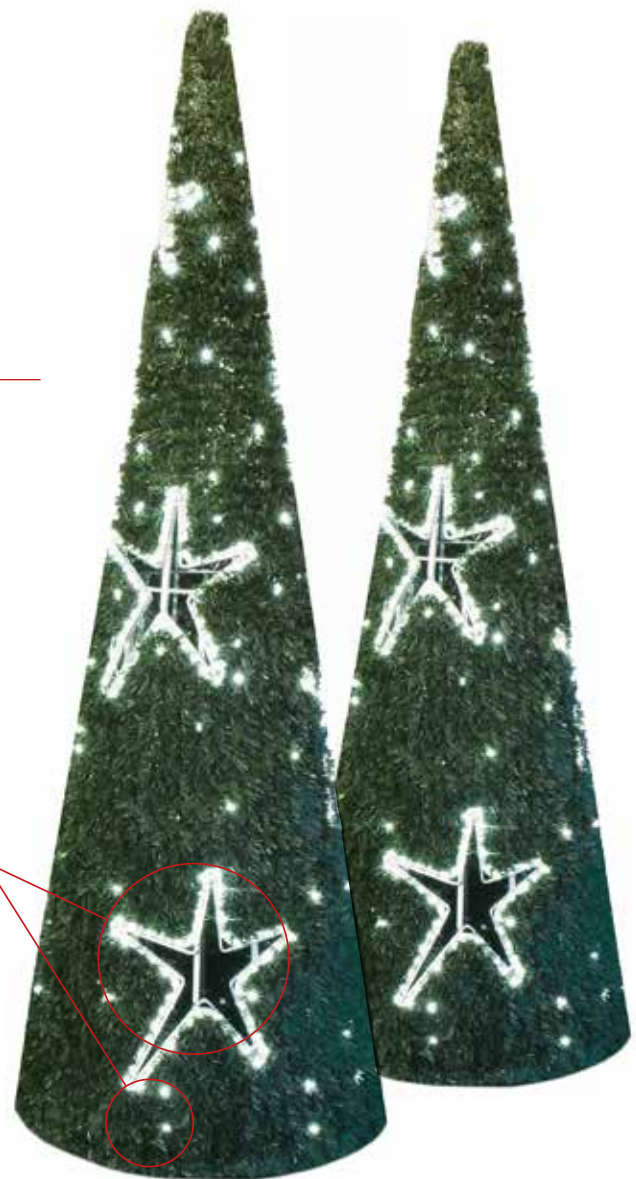

Rope Light

Easy and cost-effective outlining tool for decorative accent lighting

Rope Light is a beautiful decorative lighting product, perfect for any event or special occasion and fit to be used all year round due to their versatility and durability. Rope Light is ideal for outlining your pool or patio, bar decoration, wrapping columns, outlining structures or any other accent lighting task indoor or outdoor.

Tronix has an amazing selection of LED and Incandescent Rope Lights to fit your needs, offering large choice in color and matching accessories for fast and custom-made results. From holiday lighting to all-year round decorations, Tronix has the rope lighting solution that will work for you.





Tronix Rope Light integrates with Pro System Modular light designs in 100% matching colors!

Standardly delivered in the light colors 2400K, 3000K and 6500K, our Rope Light integrates perfectly with Pro System Modular products, resulting in spectacular and uniform light results.

proSYSTEM 
MODULAR

Rope Light | 230V

LED ROPE LIGHT | 230V | 50/51M

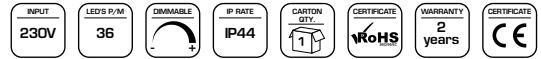

Input voltage: 230V
LED type: DIP LED
LED structure: Vertical / horizontal
Dimmable: Yes
IP rate: IP44
Length: 50/51 meter
Diameter: 13 mm
Max. to connect: 50/51 meter
Power cable: Included (Schuko Ungrounded Plug)
Carton quantity: 1

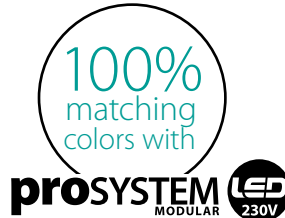

ART. NR.	LIGHT COLOR	LENGTH	LED STRUCTURE	POWER	✂	LED QTY
055-001	☼ Cold white	51 meter	Vertical	3,2 Watt/Meter	150 cm	36 LED p/m
055-011	○ White + Twinkle	51 meter	Vertical	3,2 Watt/Meter	150 cm	36 LED p/m (4 twinkle)
055-008	○ Warm white (3000K)	51 meter	Vertical	3,2 Watt/Meter	150 cm	36 LED p/m
055-010	○ Warm white+ (2400K)	50 meter	Vertical	3,2 Watt/Meter	150 cm	36 LED p/m
055-000	🌈 Multi-Color	50 meter	Vertical	2,4 Watt/Meter	200 cm	36 LED p/m

ART. NR.	LIGHT COLOR	LENGTH	LED STRUCTURE	POWER	✂	LED QTY
055-101	○ Cold white (6500K)	50 meter	Horizontal	3,2 Watt/Meter	100 cm	36 LED p/m
055-108	○ Warm white (3000K)	50 meter	Horizontal	3,2 Watt/Meter	100 cm	36 LED p/m
055-110	○ Warm white+ (2400K)	50 meter	Horizontal	3,2 Watt/Meter	100 cm	36 LED p/m



Vertical structure



Horizontal structure

ART. NR. ACCESSORIES - 230V LED ROPE LIGHT

065-005 Power Cable EU for 230V LED Ropelight & End Cap - IP44 | 1,5M



Power cable EU
Art. nr. 065-005

Vertical LED Structure

Horizontal LED Structure

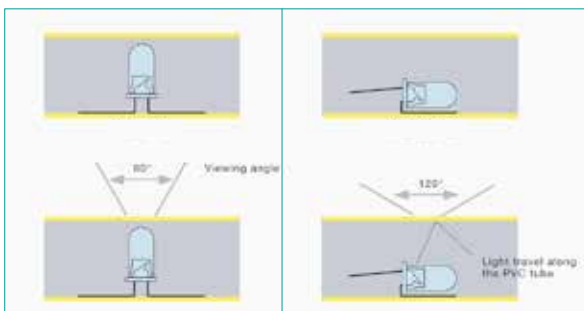

230V | Rope Light

LED ROPE LIGHT | 230V | 50M

With colored PVC. When the Rope Light is switched off, it still retains its color.



- Input voltage:** 230V
- LED type:** DIP LED
- LED structure:** Horizontal
- Dimmable:** Yes
- IP rate:** IP44
- Length:** 50 meter
- Diameter:** 13 mm
- Max. to connect:** 50 meter
- Power cable:** Included (Schuko Ungrounded Plug)
- Carton quantity:** 1

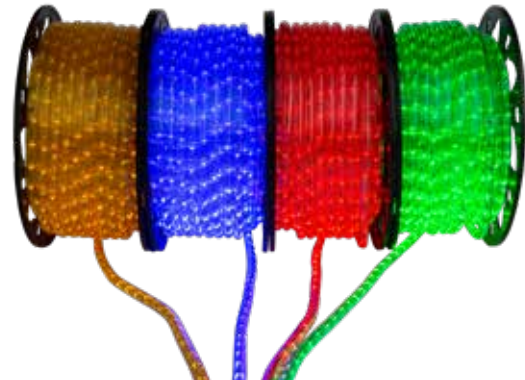

ART. NR.	LIGHT COLOR	LENGTH	LED STRUCTURE	POWER	✂	LED QTY
055-102	● Blue	50 meter	Horizontal	3,2 Watt/Meter	100 cm	36 LED p/m
055-103	● Green	50 meter	Horizontal	3,2 Watt/Meter	100 cm	36 LED p/m
055-104	● Red	50 meter	Horizontal	2,4 Watt/Meter	100 cm	36 LED p/m
055-105	● Yellow	50 meter	Horizontal	2,4 Watt/Meter	100 cm	36 LED p/m

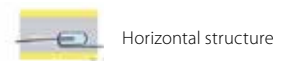

ART. NR. ACCESSORIES - 230V LED ROPE LIGHT

065-005	Power Cable EU for 230V LED Ropelight & End Cap - IP44 1,5M
485-160	PVC Channel To guide the direction of Rope Light 2M
485-165	PET Channel UV-, Chlorine-, Salt-, & Water resistant 2M
485-170	Aluminium Channel High quality with high light output 2M



Power Cable EU
Art. nr. 065-005

PVC Channel
Art. nr. 485-160

PET Channel
Art. nr. 485-165

Aluminium Channel
Art. nr. 485-170

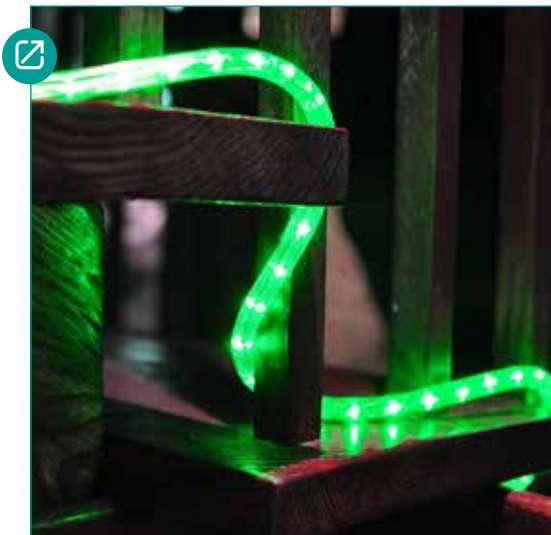

ROPE LIGHT 2.0: COLOR ALWAYS VISIBLE

Tronix introduces Rope Light with colored PVC in the colors green, yellow, blue and red. Rope Lights are perfect when it comes to creating big light designs. Why choosing colored PVC instead of regular Rope Light? They always keep their color, also when switched off to make sure your light creation will be visible at all times.

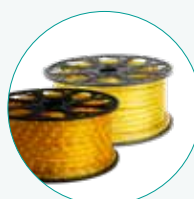

Available in 4 different colors: green, yellow, blue and red



IP44, 230V with Schuko ungrounded Power cable included



Retains their color when being switched off so always visible light creations

Rope Light | 12/24V

LED ROPE LIGHT | 24V | 30M

24V Rope Light available in 6 colors - including power cable



Input voltage: 24V
LED qty: 36 LED p/m
LED type: DIP LED
LED structure: Vertical / horizontal
Dimmable: Yes
IP rate: IP44
Length: 30 meter
Diameter: 13 mm
Max. to connect: 30 meter
Power cable: Included (Stripped wire)
Carton quantity: 1



ART. NR.	LIGHT COLOR	POWER	✂	LED STRUCTURE	LED QTY
050-001	○ Cold white (6500K)	2,9 Watt/Meter	17 cm	Vertical	36 LED p/m
050-008	○ Warm white (3000K)	2,9 Watt/Meter	17 cm	Vertical	36 LED p/m
050-010	○ Warm white+ (2400K)	2,9 Watt/Meter	17 cm	Vertical	36 LED p/m
050-002	● Blue	2,9 Watt/Meter	17 cm	Vertical	36 LED p/m
050-003	● Green	2,9 Watt/Meter	17 cm	Vertical	36 LED p/m
050-004	● Red	1,7 Watt/Meter	28 cm	Vertical	36 LED p/m
050-005	● Amber	1,7 Watt/Meter	28 cm	Vertical	36 LED p/m

ART. NR.	LIGHT COLOR	POWER	✂	LED STRUCTURE	LED QTY
050-101	○ Cold white (6500K)	2,9 Watt/Meter	17 cm	Horizontal	36 LED p/m
050-108	○ Warm white (3000K)	2,9 Watt/Meter	17 cm	Horizontal	36 LED p/m
050-110	○ Warm white+ (2400K)	2,9 Watt/Meter	17 cm	Horizontal	36 LED p/m

ART. NR. ACCESSORIES - 24V & 12V LED ROPE LIGHT

065-010 Connection Set for 12/24V Ropelight with End Cap & Heat shrinkable tube - IP44 | 1,5M | Stripped wire



Connection Set 24V/12V
Art. nr. 065-010

LED ROPE LIGHT | 12V | 15M

12V Rope Light available in 2 colors - including power cable



Input voltage: 12V
LED qty: 36 LED p/m
LED type: DIP LED
LED structure: Vertical
Dimmable: Yes
IP rate: IP44
Length: 15 meter
Diameter: 13 mm
Max. to connect: 15 meter
Power cable: Included (Stripped wire)
Carton quantity: 5



ART. NR.	LIGHT COLOR	POWER	✂	LED STRUCTURE	LED QTY
045-001	○ Cold white (6500K)	2,9 Watt/Meter	8,3 cm	Vertical	36 LED p/m
045-008	○ Warm white (3000K)	2,9 Watt/Meter	8,3 cm	Vertical	36 LED p/m

ART. NR. ACCESSORIES - 24V LED ROPE LIGHT

065-010 Connection Set for 12/24V Ropelight with End Cap & Heat shrinkable tube - IP44 | 1,5M | Stripped wire



Connection Set 24V/12V
Art. nr. 065-010

GENERAL ACCESSORIES FOR 13MM ROPE LIGHT

Suitable for LED Rope Light 13 mm

ART. NR. GENERAL ACCESSORIES

055-510 Rope Light unrolling tool

ART. NR. CHANNELS FOR 13MM ROPE LIGHT - BUNCH QTY 50 PCS

485-160 PVC Channel 2M

485-165 PET Channel 2M - UV/Chlorine/Salt Water-Resistant

485-170 Aluminium Channel 2M - UV resistant but sensitive to extension with heat

ART. NR. MOUNTING CLIPS FOR 13MM ROPE LIGHT

485-070 Mounting Clip 25 pcs in a bag

485-065 Crocodile clip 100 pcs in a bag

ART. NR. CONNECTORS FOR 13MM ROPE LIGHT

CARTON QTY.

485-050 Splice Connectors & Glue - 2 pc 50 x 2

485-085 Invisible Splice Connector - 1 pc 100

485-090 Male Pin Connector - 1 pc 100

485-105 T-Connector - 1 pc 50

485-110 X-Connector - 1 pc 50

485-100 End Cap - 1 pc 100

485-055 Glue Tube - 1 pc 50

485-113 Heat shrinkable tube + glue - 10 pcs 100 x 10



Rope Light unrolling tool
Art nr.: 055-510



PVC CHANNEL

To guide the direction of Rope Light
Art. nr. 485-160



PET CHANNEL

UV-, Chlorine-, Salt- & Water Resistant
channel to guide the direction of Rope Light
Art. nr. 485-165



ALUMINIUM CHANNEL

High quality channel for rope light
direction with high light output because
of more reflection
Art. nr. 485-170



MOUNTING CLIP

Can be screwed into any surface to fix and
direct rope light in any direction
Art. nr. 485-070



COUPLING SET

To connect Rope Lights. Also used to
reconnect when replacing a damaged
piece of Rope Light.
Art. nr. 485-050



INVISIBLE SPLICE CONNECTOR

Invisible Splice Connector
Connector is less noticeable
Art. nr. 485-085



MALE PIN

Art. nr. 485-090



T-CONNECTOR

3 connectors with one run to make
T-sections in your design
Art. nr. 485-105



X-CONNECTOR

Four runs meet in one intersec-
tion to make cross-sections
Art. nr. 485-110



END CAP

To seal the end of a (cutted) tube
Art. nr. 485-100



PVC GLUE

To glue on the end cap
Art. nr. 485-055



HEAT SHRINKABLE TUBE (10 PCS)

To make Rope Light (extra)
waterproof
Art. nr. 485-113



CROCODILE CLIP

100 pieces
Art. nr. 485-065

Rope Light | Instructions

HOW TO USE ROPE LIGHT

Tronix Rope Light 230V is delivered with a Europlug and 24V/12V comes with stripped wire suitable for DC power supply. Tronix Rope Light comes with a fixed end cap.



Before you start:

- Make sure that the main voltage is not connected during installation
- Make sure that the main voltage of the Rope Light is the same as the main voltage of the power supply.
- Led Rope Light 230V comes with a power cable with standard converter. For 24/12V Rope Light, make sure to use stabilized DC power supply to avoid that the Led's will start to flicker.

Check the **Rope Light instruction manual for more detailed instructions** included with the product and available at www.tronixlighting.com

Unrolling

To protect and avoid damage to the wire it is very important to unroll the rope light from the reel in the right way. Please make sure to position the reel in such a way that the rope light can be rolled off in a straight line instead of having to make circles. This prevents loops or swaying which could damage the internal wiring.

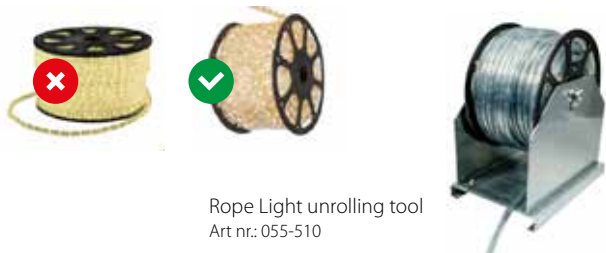

Rolling off Rope Light in the wrong way may cause unrepairable damage to the product!

Preheat before use

Sometimes it is necessary to preheat the rope light for easy installation and best results.

- In case of a low product or outside temperature we advise to preheat the rope light to ease installation and safeguard product quality.
- In case you want to make several bends/curves for your lighting project it is very important to preheat the rope for best results.



- Disconnect the main supply before starting the assembly and unroll (part of) the ropelight before starting to work with the material. You can do this by connecting the required length to the main supply, allowing the Rope Light to burn for a couple of minutes until it is flexible.
- Never connect the main voltage while the light tube is still on the reel; the heat development can cause fire!

For all Tronix Rope Light Connectors & Accessories – check page 63

We offer large choice in Rope Light connectors and other accessories to splice, cut and connect Rope Light in any desired way to make sure that you have everything you need for your lighting project and achieve the best results.

Cutting Rope Light

- First make absolutely sure that the main voltage is not connected!
- Measure the desired length and cut at the nearest cutting mark - **picture 1**.
- Use a pair of sharp cutting pliers and make sure the edge is smooth and at the right angles - **picture 2**.
- After cutting, remove any excess copper wire. There is no difference in how to cut LED rope light. The distance between the cut marks vary, depending on the rope light. To achieve maximum chasing effects, 3, 4 and 5 wire rope light need to be connected to a controller.



1. Cut rope light only at marks



2. Cut rope light neatly



Only cut the Rope Light at the identification mark, otherwise part of the tube will be permanently useless.

Connecting Rope Light

- Remember that the two pieces of rope light you want to connect, must be the same in voltage and wire count (2-wire, 3-wire etc.)
- When connecting LED Rope Light 230V/24V/12V to a transformer, always use a power cable with a converter, otherwise the LED's will start to flicker. For low voltage it is best to use a stabilized DC power supply; in this case you don't need a converter.
- Bring the holes at rope light end in the same position with the prongs ("teeth") of the connector – **picture 3** – then firmly press the pieces together.
- Tronix offers many different connectors – **picture 4** – each one unique for connecting rope in any requested shape or design.
- All rope light accessories must correspond with the shape and diameter of rope light you want to use.
- **TIP:** if a section of the rope light malfunctions (in time), simply remove the unlit section and place the working sections back together with a connector



3. Connecting rope light



4. Insert connector and press



T-Connector



X-Connector



Male Pin Connector



Invisible Splice Connector



Heat Shrinkable Tubes

Bending Rope Light

- Make sure to preheat the Rope Light a little bit to make easier curves
- It is very important to bend Rope Light perpendicular - straight up or down - at the wires. Make absolutely sure to bend rope light in the right direction – pictures 5 & 6 – to make sure that the two internal wires make the same curve.

! Avoid at all times that the inner side wire needs to make a very sharp curve. Bending rope light incorrectly can cause damage to the internal wiring. Please check picture 5 and 6



5. Bending wrong way



6. Bending right way

Applying and fixing Rope Light

There are many ways to apply rope light: you can use it to wrap objects like pillars or trees, or for a glamorous outline of your bar, swimming pool or fence. Or just hang it using suitable fixing points to create any dimension you like. Fixing Rope Light requires minimal experience, you just need the right accessories (see page 61). Whichever accessory you use, make sure there is proper mounting in each foot of the rope light, with additional mounting at every corner and curve. Depending on the application and specific circumstances different fixing materials are available. Use tie-wraps along a steel wire or preshaped frame; for outdoor usage take the UV-durable quality. Consider the following accessories when deciding how to mount rope light. These will help you learn how to secure rope light in no time at all.



ROPE LIGHT CHANNEL

To guide the direction of the rope light. Mostly used for straight paths. Gives a professional look.



MOUNTING CLIP

To direct the rope light even better in curvy areas or corners.



ZIP TIES

To secure rope lighting onto metal railings or any surface suitable for zip tie. Pull tightly and cut excess sticking out from the tie

Power

After the rope light has been designed, be sure to place a power connector at one end – picture 7 – so the rope light can be plugged into an outlet. Where the run of rope light completes, simply place an end cap – picture 8. Always seal the end of the (cutted) tube with an end cap. The end cap must be glued on with pvc or silicon glue



7. Rope Light Power Connector



8. Rope Light End Cap

- !**
- Make sure there is enough ventilation so that any possible heat can flow off
 - Do not assemble on surfaces that can vibrate or rattle violently due to severe wind
 - Rope Light spanned over roads or large surfaces must be allowed some movement with the wind
 - When applying Rope Light on a flat surface, make sure the part of the tube producing the most light is facing front!
 - Recommended fixation distance for clips & zip ties (tie wraps): horizontal 20 cm and vertical 30 cm.
 - Make sure the rope light does not make any twists in the process
 - Aluminium channels may be subject to expansion, meaning that 2m channels can differ in length with several millimeters. Make sure to keep about 4mm of space between two channels.



Power Cord
LED rope lights will include an inline rectifier integrated into the power cord.

Power Connector
Attaches the power cord to the rope light.

Rope Light
Inner wires run length of rope light, connecting bulbs. Rope light can be cut in certain intervals, look for cut marks on outer tubing

End Cap
Protect exposed end from debris.

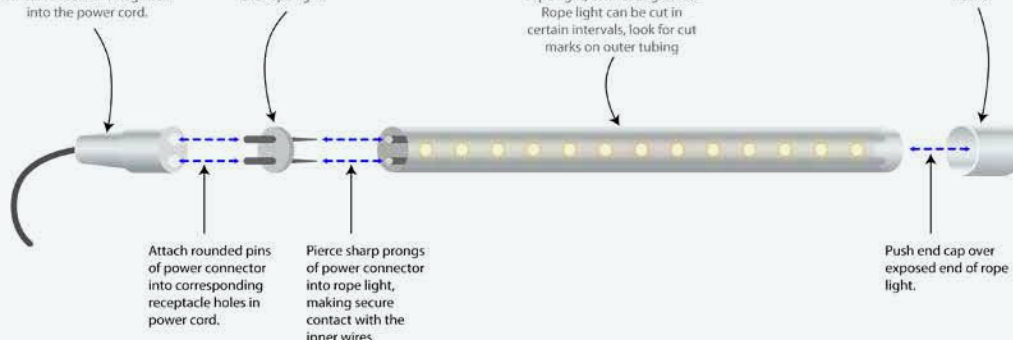

Festoon Cable Light

Makes an attractive picture of every party or event!

Are you looking for ambient Warm white or very colorful party lighting for your indoor or outdoor event? Then the so-called 'Festoon Cable light' with special LED Festoon cable lamps would be an excellent and popular choice. You just hang this multi-use party light cable gracefully from one tree, wall, party tent - or any other object - to the other, plug it into the socket and the party can begin!

Looking at the Tronix LED Festoon Cable light range, you can choose between a ready-to-use set with a mix of colored lamps, or individual Festoon cables that still need to be combined with Warm white or colored lights. Tronix Festoon cables are made of high-quality black rubber, with the E27 fittings pre-mounted on the cable with a rubber sealing ring. The standard cable is provided with a plug and end piece making it ready for use.

Our choice in lamps is also versatile. The hood of our special LED Festoon cable lamps is made of a strong polycarbonate material, making them shock-resistant. But other lamps can also be very suitable depending on the application. Consider for example our ambient filament lamps with a warm vintage look to be combined with one or a mix of different lamp types for a stylish or more playful effect.

For custom-made projects, all parts can be delivered separately to make any desirable length and to decide how many fittings per meter should be applied onto the cable. All in all a very suitable product for any party or in-/outdoor event, and that you will be able to enjoy for many years!

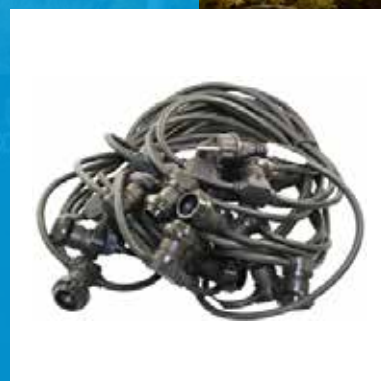
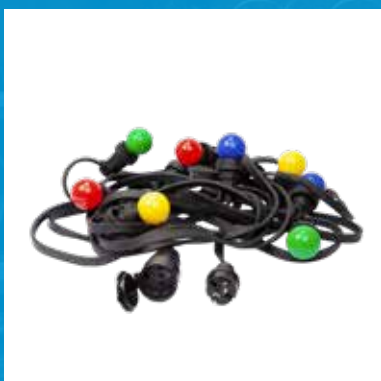



Outdoor café decorated with Tronix Festoon cable Light - Uden, the Netherlands

Festoon Cable Light

FESTOON LIGHT PROFI SET | 20 METER 20 MOULDED SOCKETS | EXCLUDING LAMPS

Professional set with high quality moulded sockets



- Input voltage:** 230V
- Socket qty:** 20
- Socket space:** 100 cm
- IP rate:** IP44
- Cable:** 2 x 1,5 mm²
- Cable length:** 20 m
- Fitting:** E27
- Length from plug to first bulb:** 50 cm
- Festoon cable color:** Black
- Festoon cable material:** Rubber
- Carton quantity:** 2



ART. NR.	LENGTH	CABLE COLOR	SOCKET QTY	SOCKET SPACE	LAMPS INCLUDED	CARTON QUANTITY
585-038	20 meter	● Black	20	100 cm	No	2

BELT LIGHT | 230V | 10M | INDOOR & OUTDOOR

Available in Warm white+, Warm white or Multicolor (red, yellow, blue, green, white).
Connectable up to 10 pcs, including Schuko power cable 010-013.



- Input voltage:** 230V
- Power:** 4,6W
- Led qty:** 25
- Led space:** 30 cm
- IP rate:** IP65
- Cable:** 2 x 0,5 mm²
- Cable Length:** 10 m
- Connectable:** Yes
- Dimmable:** Yes, triac
- Belt Light cable color:** Black
- Belt Light cable material:** Rubber
- Light color:** Warm White+, Warm White or Multicolor (steady)
- Power cable:** 150 cm Schuko Power Cable included

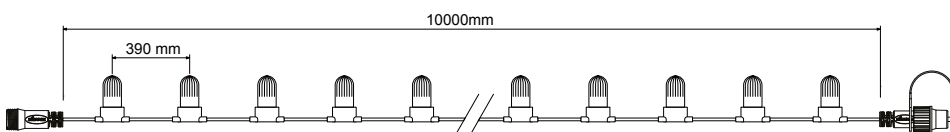

ART. NR.	LENGTH	CABLE COLOR	LED QTY	SOCKET SPACE	LAMPS INCLUDED	CARTON QUANTITY
024-078	10 meter	● Black	○ Warm white 3000K	25	39 cm	Yes 10
024-079	10 meter	● Black	○ Warm White+ 2400K	25	39 cm	Yes 10
024-070	10 meter	● Black	○ Multicolor + white	25	39 cm	Yes 10

Festoon Cable Light

FESTOON CABLE | PRE-MOUNTED SOCKETS

Festoon cable with pre-mounted sockets and with plug & contra plug



Input voltage: 230V

Socket space: 50/100 cm

Cable: 2 x 1,5 mm²

Length from plug to first bulb: 50 cm/100 cm

IP rate: IP44

Flat cable color: Black

Flat cable material: Rubber



ART. NR.	LENGTH	CABLE COLOR	SOCKET QTY	SOCKET SPACE	LAMPS INCLUDED	CARTON QUANTITY
585-036	10 meter	● Black	10	100 cm	No	4
585-022	NEW 20 meter	● Black	40	50 cm	No	2
585-037	20 meter	● Black	19	100 cm	No	2
585-027	50 meter	● Black	100	50 cm	No	1
585-023	100 meter	● Black	100	100 cm	No	1

ART. NR. FESTOON CABLE ACCESSORIES

585-020	Festoon cable with undergrounded Schuko plug and contra plug without sockets 25M
585-006	Festoon cable with undergrounded Schuko plug and contra plug without sockets 100M
585-025	Sockets E27 - set of 20 pcs
585-026	Sockets E27 - set of 100 pcs
585-029	End cap with hook
585-030	Festoon cable connector
585-031	Festoon cable Schuko plug
585-032	Festoon cable Contra Schuko plug



FESTOON CABLE 25 METER OR 100 METER

Art. nr 585-020 / 585-006



E27 SOCKET COMPONENTS

Set of 20 or 100 pcs.
Art. nr 585-025 / 585-026



END CAP WITH HOOK

Art. nr 585-029



FESTOON CABLE CONNECTOR

Art. nr 585-030



FESTOON CABLE | SCHUKO PLUG

Art. nr 585-031



FESTOON CABLE | CONTRA SCHUKO PLUG

Art. nr 585-032

Festoon Cable Light | Lamps

LED P45 | 1 OR 2 WATT | PC CAP

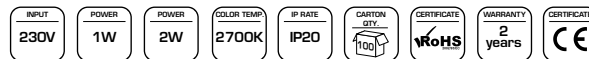

Input voltage: 230V
Power: 1 Watt or 2 Watt
Color temperature: 2700K
Color: Warm white
Diameter: 45 mm
Length: 69 mm
Dimmable: No
Material: Polycarbonate (plastic)
Carton quantity: 100 pcs
Connection type: E27



ART. NR.	LIGHT COLOR	COLOR TEMP. (CCT)	POWER	POWER FACTOR	LUMEN	BEAM	LED QUANTITY
165-000	○ Warm white	2700K	1 Watt	n.a	51 Lm	190°	6
165-009	○ Warm white	2700K	2 Watt	n.a	85 Lm	190°	10

LED P45 | 1 WATT | PC CAP



Input voltage: 240V
Power: 1 Watt
IP rate: IP20 (IP44 when applied)
LED quantity: 6
LED type: SMD
Dimmable: No
Material: Polycarbonate (plastic)
Carton quantity: 100 pcs
Connection type: E27



ART. NR.	LIGHT COLOR	COLOR TEMPERATURE	POWER	IP RATE	LUMEN	BEAM ANGLE	LED QUANTITY
165-031	○ Cold white	6000K	1 Watt	IP44	62 Lm	190°	6
165-038	○ Warm white	2700K	1 Watt	IP44	50 Lm	190°	6
165-032	● Blue	n.a.	1 Watt	IP44	n.a.	190°	6
165-033	● Green	n.a.	1 Watt	IP44	n.a.	190°	6
165-034	● Red	n.a.	1 Watt	IP44	n.a.	190°	6
165-035	● Yellow	n.a.	1 Watt	IP44	n.a.	190°	6
165-036	● Orange	n.a.	1 Watt	IP44	n.a.	190°	6

Quality guaranteed | Festoon Cable Light



SAFETY & DURABILITY FIRST

There is a huge difference between professional Festoon Party Light - the Tronix kind - and the much cheaper party lighting products you can find online or at any DIY or discount store. Professionals know this, but end customers often don't. For safe use, long-term durability, and flexibility in custom-made results it is important to pay attention to this. When looking for sustainable product solutions to count on all-year round, poor product decisions will ultimately make you regret putting price first.

WARRANTY 3 YEARS



We fully confide in our products and know that we can guarantee our customers the best quality. That's why we provide full warranty for three years.

 We hebben het volste vertrouwen in onze producten en weten dat we onze klanten hoge kwaliteit kunnen garanderen. Daarom geven we 3 jaar garantie.

WEATHER RESISTANCE



Combined with our 165-series PC cap 1W light bulbs, Tronix Festoon Cable withstands extreme weather conditions such as rain, hail and snow, and all kinds of 'wind carried' debris. We use high quality rubber that remains strong and flexible because it 'adapts' to temperature differences, resulting in high resilience and a maximum resistance to weather influences. In addition, all festoon light fittings are equipped with rubber sealing rings to ensure a waterproof connection. With fittings and lamps hanging downwards – as will normally be the case, you can always count on a waterproof product performance.

 In combinatie met onze 165-serie PC-kap 1W lampen, is Tronix prikkabel bestand tegen extreme weersomstandigheden zoals regen, hagel en allerlei soorten 'windgedragen' vuil. We gebruiken rubber van hoge kwaliteit dat sterk en flexibel blijft omdat het zich 'aanpast' aan temperatuurverschillen voor hoge veerkracht en hoge bestendigheid tegen weersinvloeden. De fittingen hebben bovendien rubberen afdichtingen voor een hoogst haalbare waterdichtheid.

CE CERTIFIED PRODUCT



Maximum safety guaranteed with CE and RoHS certified Tronix Festoon light, complying with all European safety, health and environment regulations.

 Maximale veiligheid gegarandeerd met onze CE en RoHS gecertificeerde Festoon Prikkabelverlichting, die voldoet aan alle Europese veiligheids-, gezondheids- en milieuriichtlijnen.

HIGH QUALITY RUBBER



For Festoon Lighting products, Tronix uses high quality rubber cables designed for high flexibility and good resistance to all weather conditions. This type of material is easy to work with because it is very flexible and therefore ideally suited for hang-up between two objects, or to decorate an object. Another advantage of rubber is that it "works", so it adapts to temperature differences and breaks less easily.

 Voor Festoon Prikkabelverlichting maakt Tronix gebruik van hoge kwaliteit rubberen kabels, ontworpen voor hoge flexibiliteit en bestendigheid tegen wisselende weersomstandigheden. Dit type materiaal is makkelijk om mee te werken omdat het heel buigzaam is en daarmee bij uitstek geschikt om 'golvend' of als een 'slinger' op te hangen, of voor het decoreren van objecten. Een ander voordeel van rubber is dat het 'werkt', oftewel dat het zich aanpast aan temperatuurverschillen en daarmee minder makkelijk breekt.

WATERPROOF COUPLINGS



Tronix professional festoon light cables are equipped with very user-friendly and safe rubber sealing rings on all the sockets/fittings. Firmly turning the led lamp into the fitting, a safe waterproof connection is created between the fitting and the lamp.

 De fittingen op onze professionele prikkabels zijn voorzien van rubberen afdichtingsringen. Deze zorgen voor een waterdichte afsluiting tussen de fitting en de lamp wanneer deze op stevige wijze wordt aangedraaid.

CUSTOM-MADE RESULTS



Custom-made light designs are possible with a large choice in cable length - 10 up to 100 meter - and a wide range of accessories for extension and coupling.

 Maatwerk in lichtdesign is mogelijk met een grote keuze in kabellengte - 10 tot 100 meter - en een uitgebreide assortiment aan accessoires voor verlenging en doorkoppeling.

TIPS:

- Use Tronix P45 (colored) bulbs with PolyCarbonate cap: hard to break, easy to transport and storage while mounted.
- Make sure to mount the led lamps firmly into the sockets before hanging the Festoon Light: it's much easier on the ground.

LLYSS Candles & Strings

Ambient & stylish light decoration wherever safety and efficiency come first

LLYSS stands for ambient, hazard-free and efficient lighting. Our show-stopper: Rechargeable IP44 LED candle lights with a connectable loading station, making it possible to charge up to 36 candles at the same time on one single adaptor. Ideal for the hospitality business, events branche or any other public place that asks for great but safe ambient light.

Enjoy the ambiance of real candlelight up to 20 hours and safe from wind and fire. With a slowly flickering, warm white glowing LED, they look so real that you will not be able to tell the difference with a regular tealight. Use them in just any decorative holder, fitting your personal taste or decorative background. Tall or short, wide or narrow, glass or pvc, transparent or colored: start combining to discover the wide variety in ambient light effects.

For a finishing ambient touch, use LLYSS light strings to decorate tables, trees or any other objects for that little extra magic.





LED Candle Modular System
with remote control and IP44
water resistance.

Presenting LLYSS LED Candles 2.0: a refined IP44 version of our rechargeable candles leading to more user benefits: better outdoor use, reduced charging time, the ability to charge more candles at the same time, 20 burning hours, more flexibility in product choice, and... remote control!



The ambiance of real candlelight at Michelin star restaurant Oonivoo, the Netherlands

LLYSS | LED Candles Modular

CREATING YOUR OWN LED CANDLE SET IN 5 SIMPLE STEPS

LLYSS ledlights are an ambient and safe alternative to the impractical and hazardous tealight. They save any catering entrepreneur a lot of time and money because they are rechargeable, easy to use, long-lasting with up to 20 safe and windproof burning hours. In addition, they fit any type or color deco holder for any desired mood effect.

How you assemble a LLYSS Candle Set to fit your own needs? Easy, just follow these 5 steps:

Step 1 Choose your candle color

LLYSS Led Candles are available in the colors Black and White. When choosing your candle color, keep in mind that the color and material of the candle deco holder will also have an effect on the color appearance of the candle. E.g. when a candle holder has a dark transparent color, it would be wiser to choose for a dark candle. In any other case, a white colored candle is always a good option.

Step 2 Choose the amount of candles you need

To offer customers maximum flexibility, the candles are available in sets of 6. They have a long burning time: up to 20 hours on one single load. When used in a café or restaurant, the candles need a (full) recharge every other day, which is something to consider when deciding on the number of candles you want to order.

Step 3 Choose charger base type & quantity

We offer two sizes charger bases: one for 6 candles and one for 12 candles. The charger base is universal and suitable for both black and white led candles.

Modular System: LLYSS chargers come with a small connection cable, making it possible to connect multiple charger bases in a row on one single adaptor! Up to 4x Base-6pcs and 3x Base-12 pcs.

Step 4 Calculate adaptor quantity

On a single adaptor you can connect up to maximum 4x 6-pcs base and 3x 12-pcs base to charge up to 36 candles in one time. Choose the amount of adaptors, based on your amount of candles. E.g. if you want to charge 100 candles simultaneously, you need 8x 12-pcs chargers and 1x 6-pcs charger. For charging you will then need 3 adaptors in total: 2 to each charge 3x 12 pcs-base, and one to charge 2x 12 pcs-base and a 1x 6-pcs base.

Step 5 Add a remote control

It only takes one remote control to switch all candles off or on with one single click. An essential feature for intensive and daily use in restaurants, hotels, wellness resorts and any other place that requires ambiance but where saving time and money is just as important.



IP44 rating for moist protection

The led candles are splash proof. Ideal for outdoor areas such as terraces, outdoor parties or gardens. Take the candle holder into account. Make sure that rainwater can drain and don't let the candle holder fills with water.



Authentic candle light color and flicker

With a slowly flickering, yellowish glowing light, LLYSS ledlights look so real that you will hardly be able to tell the difference with real candle light. It even beats it!



Lithium-ion battery for a long life

The candles have a Lithium-ion rechargeable battery. These have a long lifespan, making sure that you can enjoy your candles for an extra long time.



Safe alternative to the impractical firethreatening tealight

No chance of burning your fingers, staining table cloths or chairs with LLYSS Led Candles. A great product for the hospitality industry where everything revolves around ambiance, but safety and efficiency always come first.



NEW LLYSS LED CANDLES IP44

A refined range of our popular Tronix Led Candles rebranded under the name LLYSS. With enhancements on durability, productivity, personal preferences and flexibility. Create your own custom-made set with our new modular options!

2.0 features

- IP44 for protected outdoor use
- **Modular Charger Base System:** charge up to 36 candles in one load
- **Lithium-ion battery** for a long service life
- Improved light color and flicker to match the effect of a traditional tea light
- **Remote control** function: switching them all off with one single click!
- **Tumble Switch:** tumble or turn to manually switch on/off

LED Candles Modular | LLYSS

LLYSS | 6X | IP44 | LED TEALIGHT

6x rechargeable Led Candle in black or white.

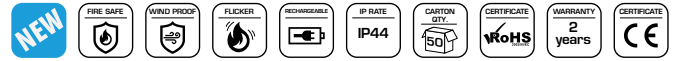

- Charger base:** Excluded
- Adaptor:** Excluded
- Remote control:** Excluded (optional)
- Led Candles:** 6 pcs
- Flame Color:** Warm white
- Operation time:** 20 hours
- Charging time:** 10 hours
- IP rate:** IP44
- Carton qty:** 50 x 6pcs



ART. NR.	COLOR	COLOR TEMP. (CCT)	LED CANDLE QTY	OPERATING TIME	CHARGING TIME
700-040	○ White	2300K	6	20 hrs	10 hrs
700-041	● Black	2300K	6	20 hrs	10 hrs



Set example: 2x 700-041, 2x 700-045,
1x 700-047

• MAX. 4 CHARGER BASES 700-045



Set example: 4x 700-040, 2x 700-046,
1x 700-047

• MAX. 3 CHARGER BASES 700-046





The atmosphere of real candlelight - Oonivoo Uden, the Netherlands

LED Candles Modular | LLYSS

LLYSS | CHARGER BASE FOR 6 OR 12 TEALIGHTS

Charger Base including 1x connecting cable



- Input:** 230V
- Adaptor:** Excluded
- Led Candles:** Excluded
- Charging time:** 10 hours
- IP rate:** IP20
- Carton qty:** 20



ART. NR.	FOR LED CANDLE	CHARGING TIME	MAX TO CONNECT
700-045	6	10 hrs	4 pcs
700-046	12	10hrs	3 pcs

LLYSS | ADAPTOR FOR CHARGER BASE

One Adaptor for max 4x Charger Bases 700-045, or max 3x Charger Bases 700-046



- Input:** 230V
- Charger Base:** Excluded
- Led Candles:** Excluded
- Charging time:** 10 hours
- IP rate:** IP20
- Carton qty:** 50



ART. NR.	FOR LED CANDLE	CHARGING TIME
700-047	6	10 hrs

LLYSS | REMOTE CONTROL

One remote control to switch on/off an endless amount of candles



- IP rate:** IP20
- Carton qty:** 100

ART. NR.	FOR LED CANDLE
700-049	Endless

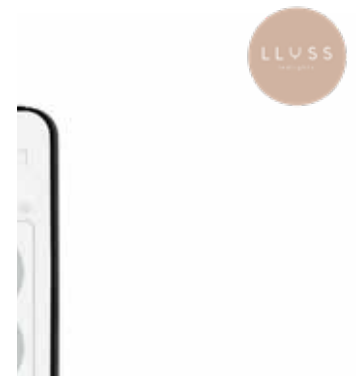





Terrace ambiance with LED candles - Van der Valk Uden, the Netherlands



Decoration with 3000K Cluster lights

LLYSS | CLUSTER 3,5M | 3000K | PLUG & PLAY

Plug & Play cluster light with eight different settings (Flash, Twinkle, on/off, steady).



Input voltage: 230V
Power: 3,6 Watt
Led quantity: 384
Led distance: 8 mm
Connectable: No
Power supply: Included
IP rate: IP44
Wire color: Black
Carton quantity: 16



ART. NR.	WIRE COLOR	LIGHT COLOR	CCT	LED QTY
740-021	● Black	☉ Warm white	3000K	384

LLYSS | 8,9M | 6500K/MULTICOLOR | PLUG & PLAY

Plug & Play Multicolor Light string with 2-button controller for eight different speed and color programs. Available in the colors Red, green, blue, yellow and white.



Input voltage: 230V
Power: 3,6 Watt
Led quantity: 384
Led distance: 8 mm
Connectable: No
Power supply: Included
IP rate: IP44
Wire color: Black
Carton quantity: 24



ART. NR.	WIRE COLOR	LIGHT COLOR	CCT	LED QTY
740-001	● Black	☉ Cold white + Multicolor	6500K + RGBY	120



MULTICOLOR LIGHT STRING: CHAMPION IN ATMOSPHERE

With 8 light programs, this Multicolor String Light offers plenty of variety. There is a button on the adapter for easy switching between programs: Steady on, slo-mo, slow fade, sequential, chasing flash, twinkle flash, waves or a combination.

Designed for instant mood lighting

Use the multicolor String Light both indoors and outdoors to cheerfully decorate (Christmas) trees or a garden fence during the holidays. The String is Plug & Play and ideal when in need of a ready-to-use product. For outdoor use, make sure that both plug and socket are protected against rain/moisture.

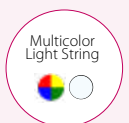

Register

007-008.....	20	010-197.....	23	011-220.....	13	018-501.....	33	165-035.....	70
007-018.....	20	010-198.....	23	011-220.....	15	018-502.....	33	165-036.....	70
007-019.....	20	010-198.....	52	011-221.....	15	018-520.....	32	165-038.....	70
007-020.....	20	010-198.....	53	011-228.....	15	018-521.....	32	215-300.....	41
007-025.....	20	010-199.....	23	011-231.....	15	018-522.....	32	215-301.....	41
007-026.....	20	010-199.....	52	011-232.....	13	018-540.....	33	215-302.....	41
007-029.....	20	010-199.....	53	011-232.....	15	018-541.....	33	215-318.....	41
007-030.....	20	010-200.....	22	011-233.....	15	018-542.....	33	485-050.....	63
007-048.....	21	010-200.....	52	011-234.....	15	018-560.....	32	485-055.....	63
007-049.....	21	010-200.....	53	012-001.....	18	018-561.....	32	485-065.....	63
007-050.....	21	010-201.....	22	012-002.....	18	018-562.....	32	485-070.....	63
007-051.....	21	010-201.....	52	012-003.....	18	024-070.....	46	485-085.....	63
007-052.....	21	010-201.....	53	012-009.....	18	024-070.....	68	485-090.....	63
007-053.....	21	010-202.....	22	012-011.....	18	024-078.....	46	485-100.....	63
007-054.....	21	010-202.....	52	012-012.....	18	024-078.....	68	485-105.....	63
007-058.....	21	010-202.....	53	012-013.....	18	024-079.....	46	485-110.....	63
007-140.....	20	010-203.....	22	012-019.....	18	024-079.....	68	485-113.....	63
007-141.....	20	010-203.....	52	012-021.....	19	025-018.....	41	485-160.....	61
010-004.....	23	010-203.....	53	012-022.....	19	025-019.....	41	485-160.....	63
010-005.....	23	010-204.....	22	012-023.....	19	025-021.....	41	485-165.....	61
010-006.....	12	010-204.....	52	012-031.....	19	025-118.....	43	485-165.....	63
010-006.....	23	010-204.....	53	012-032.....	19	025-119.....	43	485-170.....	61
010-007.....	12	010-205.....	22	012-033.....	19	025-121.....	43	485-170.....	63
010-007.....	23	010-205.....	52	018-001.....	28	025-128.....	42	570-010.....	56
010-012.....	14	010-205.....	53	018-001.....	35	025-129.....	42	570-026.....	56
010-012.....	15	010-206.....	22	018-001.....	43	025-131.....	42	571-009.....	53
010-012.....	16	010-206.....	52	018-002.....	28	025-138.....	42	571-010.....	53
010-012.....	17	010-206.....	53	018-002.....	35	025-139.....	42	571-019.....	53
010-012.....	22	010-207.....	22	018-002.....	43	025-141.....	42	571-020.....	53
010-012.....	52	010-207.....	52	018-003.....	28	033-008.....	47	571-029.....	53
010-012.....	53	010-207.....	53	018-003.....	35	033-028.....	47	571-029.....	53
010-013.....	13	010-208.....	22	018-003.....	43	033-038.....	47	571-030.....	53
010-013.....	14	010-208.....	52	018-004.....	28	033-048.....	47	571-061.....	52
010-013.....	15	010-208.....	53	018-004.....	35	045-001.....	62	571-078.....	52
010-013.....	16	010-209.....	22	018-004.....	43	045-008.....	62	571-079.....	52
010-013.....	17	010-209.....	52	018-005.....	28	050-001.....	62	580-020.....	54
010-013.....	22	010-209.....	53	018-005.....	35	050-002.....	62	580-021.....	54
010-013.....	52	011-116.....	16	018-005.....	43	050-003.....	62	580-022.....	54
010-013.....	53	011-117.....	16	018-011.....	34	050-004.....	62	580-023.....	54
010-019.....	13	011-118.....	13	018-012.....	34	050-005.....	62	580-024.....	54
010-019.....	14	011-118.....	16	018-013.....	34	050-008.....	62	580-025.....	54
010-019.....	15	011-120.....	13	018-014.....	34	050-010.....	62	580-030.....	55
010-019.....	16	011-120.....	16	018-015.....	34	050-101.....	62	580-032.....	55
010-019.....	17	011-124.....	16	018-021.....	34	050-108.....	62	580-069.....	57
010-019.....	22	011-125.....	13	018-022.....	34	050-110.....	62	585-006.....	69
010-020.....	14	011-125.....	16	018-023.....	34	055-000.....	60	585-020.....	69
010-020.....	15	011-128.....	16	018-024.....	34	055-001.....	60	585-022.....	69
010-020.....	16	011-151.....	14	018-025.....	34	055-010.....	60	585-023.....	69
010-020.....	17	011-156.....	14	018-031.....	34	055-008.....	60	585-025.....	69
010-020.....	22	011-157.....	14	018-032.....	34	055-011.....	60	585-026.....	69
010-022.....	23	011-158.....	14	018-033.....	34	055-101.....	60	585-027.....	69
010-023.....	23	011-159.....	14	018-034.....	34	055-102.....	61	585-029.....	69
010-105.....	12	011-161.....	14	018-035.....	34	055-103.....	61	585-030.....	69
010-106.....	12	011-162.....	14	018-036.....	27	055-104.....	61	585-031.....	69
010-107.....	12	011-165.....	14	018-036.....	35	055-108.....	60	585-032.....	69
010-108.....	12	011-168.....	14	018-050.....	27	055-110.....	60	585-036.....	69
010-109.....	13	011-171.....	17	018-050.....	35	055-510.....	63	585-037.....	69
010-109.....	23	011-172.....	17	018-052.....	27	065-005.....	60	585-038.....	68
010-113.....	12	011-173.....	17	018-052.....	35	065-005.....	61	700-040.....	75
010-114.....	12	011-175.....	17	018-118.....	29	065-010.....	62	700-041.....	75
010-115.....	12	011-176.....	17	018-119.....	29	065-010.....	62	700-045.....	77
010-115.....	52	011-177.....	17	018-138.....	28	165-000.....	70	700-046.....	77
010-188.....	23	011-183.....	17	018-139.....	28	165-009.....	70	700-047.....	77
010-189.....	23	011-186.....	17	018-208.....	30	165-031.....	70	700-049.....	77
010-195.....	13	011-211.....	13	018-209.....	30	165-032.....	70	740-001.....	81
010-195.....	22	011-211.....	15	018-218.....	31	165-033.....	70	740-021.....	81
010-196.....	22	011-218.....	13	018-219.....	31	165-034.....	70		
		011-218.....	15	018-500.....	33				

