

OPPLE
LIGHTING.

October 2022
LED Portfolio

OPPLE.COM

OPPLE Lighting.

Dear valued customers,

I am proud to present you our new catalog, full of innovations that once again underline our promise; **“OPPLE makes affordable, high quality and innovative LED lighting”**.

Besides our proven products, the focus remains on expanding the OPPLE Smart Lighting portfolio, easy to install and user friendly. We want to make it easy for you with the Smart Converters, a simple and innovative addition to the product range. With these you can integrate any DALI, TRIAC or 1-10V dimmable fixtures into our Smart system and with the new Smart Switch Module we can even make your existing wall switches Smart.

In the outdoor lighting portfolio, our luminaires are also getting smarter. For example, the new Road lighting fixture Stratus is fully integrable into any Smart City Control system through its universal Zhaga connector. Also check out the Urban portfolio with great new products.

At OPPLE, your success is our goal. We keep it simple, respond quickly, do what we promise. The colleagues at OPPLE make it happen!

LET'S TEAM OP!



Jeroen Janssen
Managing Director
OPPLE Lighting Europe



Who we are

OPPLE in Europe started as a small team early 2014.

We are stronger than ever, more professional, more experienced, with high energy and our pure dedication to serve and surprise our customers - that's who we are, that is our ambition, that's why we do it.







Smart 12

Indoor 30

Outdoor 120

Lamps & Tools 150

Technical Data 164

Glossary 182





SMART

SMART LIGHTING

	Smart Connect Box	17
	Smart Sensor (Passive Infrared)	18
	Smart Sensor (Microwave)	20
	Smart Switch	22
	Smart Multi Switch Module > NEW	23
	Smart Relay	24
	Smart Relay DIM > NEW	25
	Smart DALI Converter > NEW	26
	Smart 1-10V Converter > NEW	27

INDOOR

PANELS (RECESSED AND SUSPENDED)

	Panel Grille	30
	Panel Monza	32
	Panel Sydney	34
	Slim Panel Performer UGR19 G5	36
	Slim Panel EcoMax G4 > NEW	40
	Slim Panel EcoMax UGR22 G2	42
	Slim Panel Basic G3 > NEW	44
	Lima	46
	Panel Suspended Zenith	48



DOWNLIGHTS





	Downlight Performer HG	50
	Downlight Performer MW > NEW VERSION	54
	Downlight Compact	58
	Downlight Slim EcoMax	60

SPOTS

	Spot Performer 3C Compact	62
	Spot Performer 3C	64
	Spot EcoMax 3C	66
	Spot Performer Swing	68
	Recessed Spot Round Adjustable HQ	70
	Recessed Spot Ava G2 > NEW VERSIONS	72
	Recessed Spot Chiara	74

WALL AND CEILING LUMINAIRES



	Wall-Mounted Performer <i>Also suitable for outdoor applications</i>	76
---	---	----

	Wall-Mounted EcoMax G2	78
	Ceiling Light Luna	80
	Ceiling Light Apollo	82
	Ceiling Light Apollo Basic	84
	Porchlight EcoMax <i>Also suitable for outdoor applications</i>	86



LINEAR LUMINAIRES

	Linear EcoMax	88
	T5 Batten EcoMax	90
	T5 Batten S with switch	92

HIGHBAYS

	Highbay Performer G4	94
	Highbay EcoMax G2	98

WATERPROOFS

	Waterproof Special <i>Also suitable for outdoor applications</i>	100
	Waterproof Performer G3	102



	Waterproof Classic	106
---	--------------------	-----

	Waterproof EcoMax G2	110
---	----------------------	-----

	Waterproof Basic	112
---	------------------	-----

TRUNKING

	Trunking	114
---	----------	-----

OUTDOOR

ROADLIGHTS

	Roadlight Stratus > NEW	120
---	--------------------------------	-----

	Roadlight EcoMax	122
---	------------------	-----

STREETLIGHTS

	Streetlight G2	124
---	----------------	-----

URBAN

	Post Top > NEW VERSIONS	126
---	--------------------------------	-----

	Bollard Performer	128
---	-------------------	-----

	Bollard Luke > NEW	130
---	---------------------------	-----

	Spot Projector	132
---	----------------	-----

	Wall Spot	134
---	-----------	-----

	Wall Light Lucia > NEW	136
---	-------------------------------	-----

FLOODLIGHTS

	Flood HO	138
---	----------	-----

	Floodlight Performer	140
--	----------------------	-----

	Floodlight Modulo Performer	142
---	-----------------------------	-----

	Floodlight EcoMax G2 Medium Power	144
---	--------------------------------------	-----

	Floodlight EcoMax G2 Low Power	146
---	-----------------------------------	-----

LAMPS & TOOLS

FILAMENTS

	Filament	150
--	----------	-----



REFLECTORS



Reflector EcoMax GU10 152

TUBES



T8 Tube 154

MODULES



Module Clio G2 156

LIGHT MASTER



Light Master G3 158

Accessories 160

TECHNICAL DATA

Cut-Out Conversion List	164
Adapter Rings Overview	165
Connection Specifications	166
IP Rated Product Overview	170
Trunking - Module allocation	171
Highbay MD Controller	172
Roadlight / Streetlight - Possible pole distances	174
Flood HO - Configuration examples	178

GLOSSARY

Definition of terms	182
Glossary	184

OPPLE ONLINE



@OppleLightingEurope

Check our website OPPLE.COM for the latest overview of our complete portfolio and related specifications.

TOOLS

- ▶ Fast Lighting Calculation
- ▶ Trunking Configurator

DOWNLOAD CENTER

- ▶ Family sheets
- ▶ Installation instructions
- ▶ Photometric data
- ▶ Energy labels
- ▶ Connection specifications
- ▶ Dimmer compatibility list
- ▶ Guarantee & Warranty policy
- ▶ Terms & conditions
- ▶ 3D (BIM) Models
- ▶ Dialux
- ▶ Relux



OPPLE.COM







Smart 12
Indoor 30
Outdoor 120
Lamps & Tools 150
Technical Data 164
Glossary 182

OPPLE Smart Lighting

With OPPLE Smart Lighting you can count on:

- Completely wireless control of lighting utilizing Bluetooth Low Energy Mesh
- Dynamic lighting without extra wiring
- Quick and easy installation, not need for a gateway
- Maximum energy savings thanks to the use of Smart Sensors
- Various scenes/moods can be set
- Unique features like daylight balance, the corridor mode, movement sensors and smart relays
- Maximum security thanks to coded signals and strict user management
- An excellent and affordable Smart Lighting system



Smart Classic

Smart Lighting for small & medium sized applications

- App based
- Simple and fast
- Bluetooth Mesh
- Scene setting
- Wireless sensors and switches
- Daylight control and corridor mode
- Independent from building



Smart Connect Box

Smart Lighting towards fully integrated solutions

- Gateway and web UI based
- Full remote control
- Bluetooth Mesh & DALI control
- Wireless sensors and switches
- Extensive configuration options
- Energy and occupancy monitoring
- Connection to BMS possible
- Unlimited project size



Available as Tunable White

- Varying colours in the same fixture
- Warm white to cool white (2700K - 6500K)
- Easy to install and control via the Smart Lighting system
- Healthcare and 24hrs applications

Compatibility with 3rd party luminaires

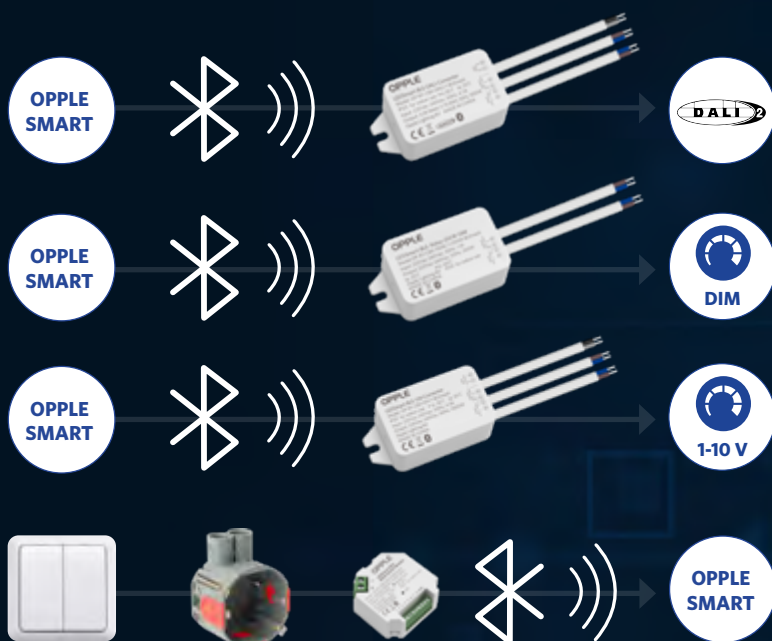

Smart Lighting Portfolio

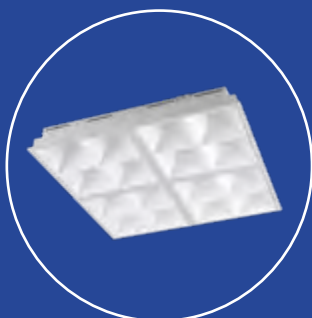

Panel Grille
→ page 30



Panel Monza
→ page 32



Panel Sydney
→ page 34

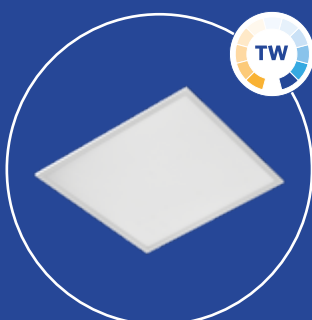

Slim Panel Performer UGR19 G5
→ page 36

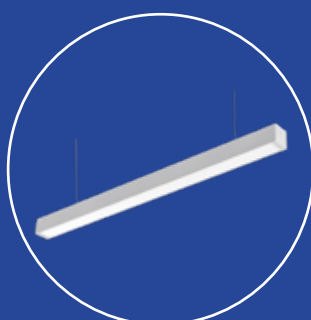

Lima
→ page 46

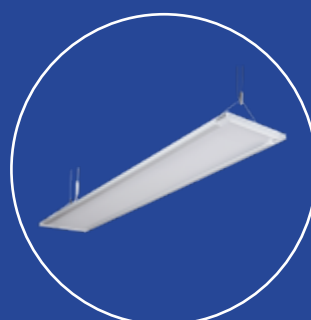

Panel Suspended Zenith
→ page 48



Downlight Performer HG
→ page 50



Downlight Performer MW
→ page 54



Spot Performer 3C Compact
→ page 62



Spot Performer Swing
→ page 68

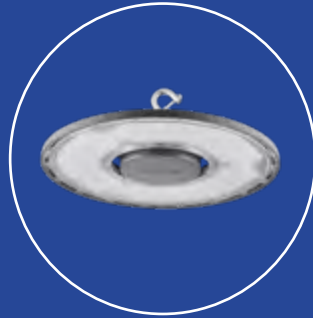

Highbay Performer G4
→ page 94



Waterproof Performer G3
→ page 102



Smart Connect Box
→ page 17



Smart Sensor
(Passive Infrared)
→ page 18



Smart Sensor (Microwave)
→ page 20



Smart Switch
→ page 22



Smart Multi Switch Module
→ page 23



Smart Relay
→ page 24



Smart Relay DIM
→ page 25



Smart DALI Converter
→ page 26



Smart 1-10V Converter
→ page 27

OPPLE Smart Connect Box

The Smart Connect box is an optional extra piece of hardware, that unlocks extra features of the Smart Lighting System. An extremely versatile device that facilitates the connection of your Smart Lighting system with the outside world.

The idea is simple: after connecting the Smart Connect Box to the network in your building, you can communicate remotely with all the Smart luminaires, sensors, and switches. The Smart Connect Box offers especially great benefits for larger buildings with multiple floors.

The benefits

- Maps out data clearly on energy consumption, temperature, humidity and occupancy detection for each building, floor and room.
- Always and everywhere in control: operate your building's lighting from a remote location.
- All DALI luminaires can be linked and operated via Smart Switch or Smart Sensor.
- Scheduler: luminaire automatic on-/off switch at a specific time or date.
- Links multiple Smart Projects in a single project.
- Completely compatible with the existing OPPLE Smart Lighting system.
- Full logic configuration of the system (IFTTT rules) is possible.
- Copy-paste function for Lighting scenes and automation rules from room to room.



Monitoring data remotely

All OPPLE Smart Lighting system devices can communicate with each other, however the Smart Connect Box now makes it possible for you to connect with and control your lighting system remotely. A great benefit of the Smart Connect Box is that you can monitor information very simply. The OPPLE Cloud offers insights into all sorts of data regarding your building, which you have at your disposal via your laptop or tablet in real time.

Mapping out energy consumption

The Smart Connect Box can generate graphs for each building, floor and room. Revealing the energy consumption within a certain period, the climate and at what times occupancy is detected. The Smart Connect Box makes it a simple matter to switch luminaires on or off or set them automatically with the scheduler. This makes the Smart Connect Box an ideal solution for facility managers for the management of large buildings. Targets for green activities such as energy consumption reduction are simpler to achieve.

It is a simple matter to connect the Smart Connect Box to your OPPLE Smart Lighting system. There is nothing for you to change or replace in your current Smart Lighting system.

OPPLE "Classic" Smart Lighting vs Connect Box	"Classic" Smart Lighting system	Smart Connect Box system
Use of Smart Switch	✓	✓
Use of Smart Sensor	✓	✓
Daylight Control	✓	✓
Multiple managers/users per project	✓	✓
Show actual occupancy	✓	✓
Show actual temperature/humidity	✓	✓
Multiple installers per project	✗	✓
Control > 100 devices at once	✗	✓
Switch lighting at specific time/date	✗	✓
Control your lighting installation remotely	✗	✓
Energy use graph	✗	✓
Temperature/humidity graph	✗	✓
Occupancy graph per area	✗	✓





Smart Connect Box

- Monitor energy consumption per building, floor or room
- Remote control of your Smart Lighting project
- Control any type of DALI luminaire via Smart Switch, Smart Sensor or Smart Web Interface
- Scheduler: automatically turn on/off luminaires at a specific time or date
- Connect multiple Smart Projects into one big project
- Fully compatible with the existing OPPLE Smart Lighting luminaires and accessories



Specifications

Item Code	Item Description
560000005700	Smart Connect Box

Technical Specifications	
Power consumption	Max 14W
Finishing	Grey
Protection Class	II
Communication	Wired: Ethernet (RJ45), DALI, RS-485 Wireless: Bluetooth® Low Energy Mesh
Integrated DALI power supply	Yes

Electrical Supply	
Nominal voltage	220-240 V AC
Frequency	50/60 Hz
Output voltage	16 V DC
Output current	Max 0.2A

Ambient Conditions	
Operating temperature	-20~+40°C
Storage environment	-25~+50°C



Dimensional drawing (mm)

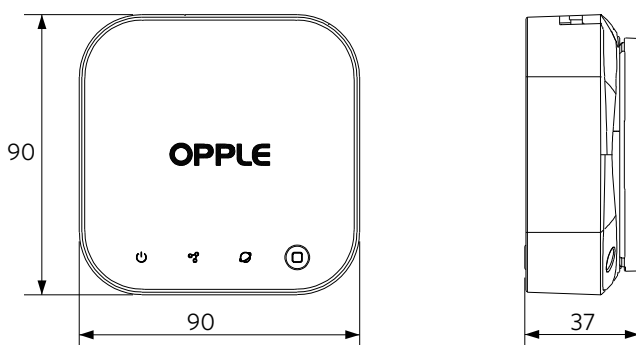

560000005700 - Smart Connect Box





Smart Sensor (Passive Infrared)

- Compact Bluetooth® presence detector for use in OPPLE Smart Lighting System
- Large detection area of Ø 10m
- Recommended mounting height 2-3,5m
- Suitable for the OPPLE Smart Daylight regulation
- Very easy to set up with the OPPLE Smart Lighting App, or Smart Connect Box through the web user interface
- Including temperature- and humidity sensors
- Complete wireless communication via Bluetooth® Low Energy (BLE)



Specifications

Item Code	Item Description	Sensor range
140063563	LEDSmartlight-Rc-Sensor	10m

Accessories



560098000600
LEDSmart-Sensor Surface-Module-WH

Technical Specifications	
IP-class	IP20
IK-class	IK02
Finishing	White RAL9003
Communication	Opplé Bluetooth® Low Energy Mesh
Protection Class	II
Detection diameter (when installed at 2-3.5m height)	Max Ø 10m Max Ø 5m when sitting
Detection angle	360°
Detection technology	Passive Infrared (PIR)
Switch-off delay time	1min-60min
Daylight balance	Yes
Temperature sensor	Yes
Humidity sensor	Yes

Electrical Supply	
Power consumption	1.2W
Nominal voltage	220-240 V AC
Frequency	50/60 Hz

Mechanical Properties	
Material housing	PC

Ambient conditions	
Operating Temperature	-25-+30°C



Dimensional drawing (mm)

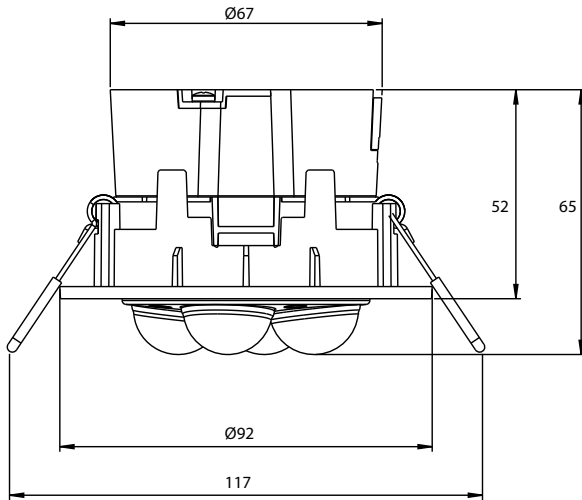

560098000600 - LEDSmart-Sensor Surface-Module-WH

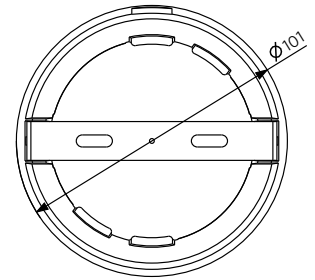
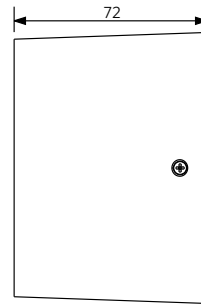

560098000600 - LEDSmart-Sensor Surface-Module-WH

Installation opening drawing (mm)

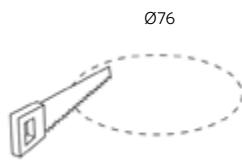

LEDSmartlight-Rc-Sensor

Detection range (for micro-movements)

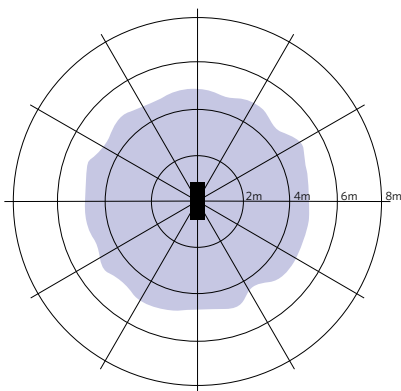

Installation - Low Ceiling
Suggested installation height 2-3m





Smart Sensor (Microwave)

- Compact Bluetooth® presence detector for use in OPPLE Smart Lighting System
- Large detection area of Ø 20m
- Very easy to set up with the OPPLE Smart Lighting App, or Smart Connect Box through the web user interface
- Suitable for high ceiling applications (max detection height of 13m)
- Adjustable detection area for low/high ceiling applications
- Complete wireless communication via Bluetooth® Low Energy (BLE)



Specifications

Item Code	Item Description	Sensor range
560000008400	LEDsmartlight-Rc-MW-Sensor	20 m

Accessories



IP20

560098000600
LEDsmart-Sensor Surface-Module-WH



IP65 IK07

560006000900
LEDsmart-Sensor IP65-Base-Module
Excluding sensor



IP65 IK07

560006001000
LEDsmart-Sensor IP65-Module
Excluding sensor

Technical Specifications	
IP-class	IP20 / IP65*
IK-class	IK02 / IK07*
Finishing	White RAL9003
Communication	Opplé Bluetooth® Low Energy Mesh
Protection Class	II
Detection diameter (when installed at 2.5-13m height)	Max Ø 20m
Detection angle	360°
Detection technology	Microwave (MW)
Switch-off delay time	1min-60min
Daylight balance	No
Temperature sensor	No
Humidity sensor	No

Electrical Supply	
Power consumption	2.2W
Nominal voltage	220-240 V AC
Frequency	50/60 Hz

Mechanical Properties	
Material housing	PC

Ambient conditions	
Operating Temperature	-30~+55°C

5 YEARS WARRANTY



* Only in combination with IP65 accessory modules



Dimensional drawing (mm)

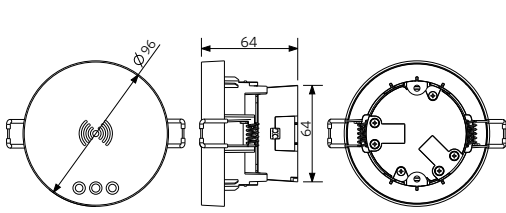

560000008400 - LEDSmartlight-Rc-MW-Sensor

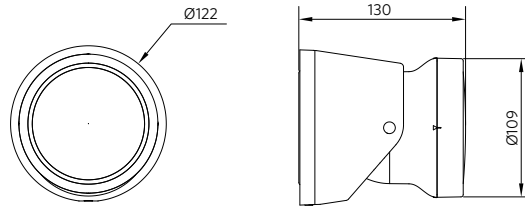

560006000900 - LEDSmart-Sensor IP65-Base-Module

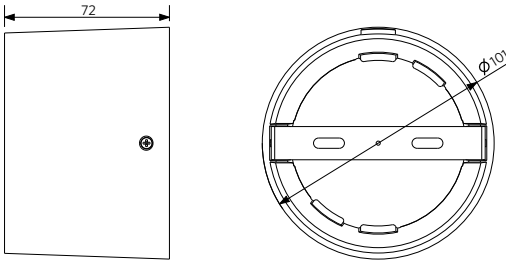

560098000600 - LEDSmart-Sensor Surface-Module-WH

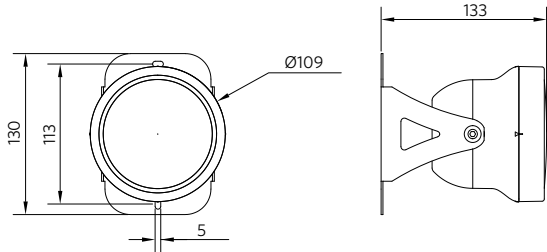

560006001000 - LEDSmart-Sensor IP65-Module

Detection range

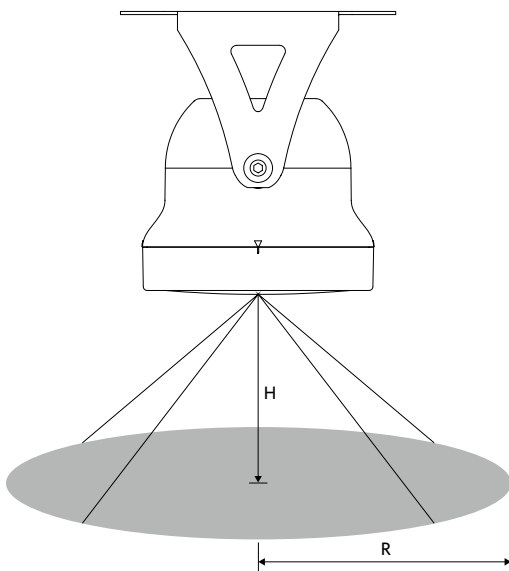

Installation opening drawing (mm)

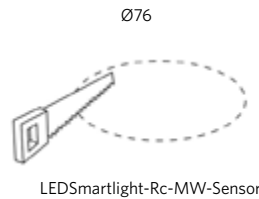

LEDSmartlight-Rc-MW-Sensor

Recommended Height (m)	Sensitivity Setting	Detection Radius (m)
3	Low	7
8	Middle	9
9	High	10
12	High	7

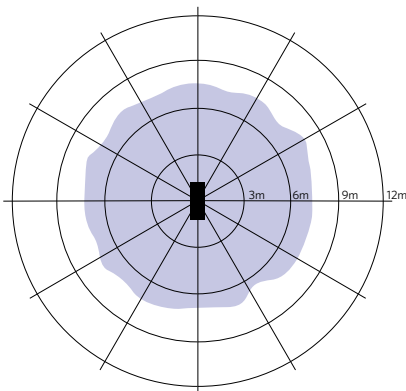

Installation - Low Ceiling
Suggested installation height 3m

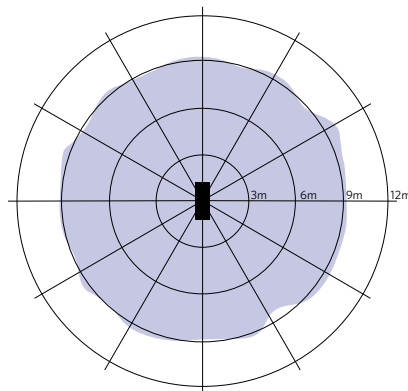

Installation - Medium Ceiling
Suggested installation height 8m

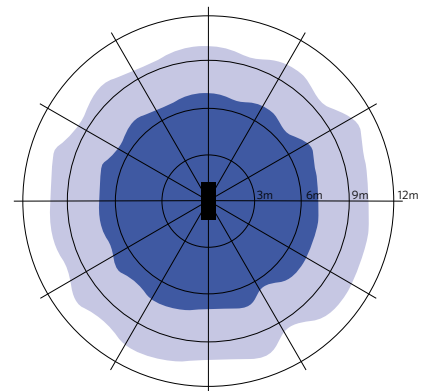

Installation - High Ceiling
Suggested installation height 9-12m





Smart Switch

- Smart Relay for use in the OPPLE Smart Lighting System
- Simple wireless control of each type/brand of luminaire
- Compatible with OPPLE Smart Sensors and OPPLE Smart Switches
- Very easy to set up with the OPPLE Smart Lighting App, Smart Connect Box or Smart Web Interface
- Including built-in energy meter, to read out in the app or web user interface
- Complete wireless communication via Bluetooth® Low Energy (BLE)
- Also suitable for control of Class I luminaires



Specifications

Item Code	Item Description
140063564	LEDSmartlight-Switch

Technical Specifications	
IP-class	IP20
IK-class	IK02
Finishing	White RAL9003
Communication	Opplé Bluetooth® Low Energy Mesh

Electrical Supply	
Nominal voltage	3
Type of battery (incl.)	CR2430
Min. lifespan battery	2 years

5 YEARS WARRANTY



Mechanical Properties	
Material housing	PC

Dimensional drawing (mm)

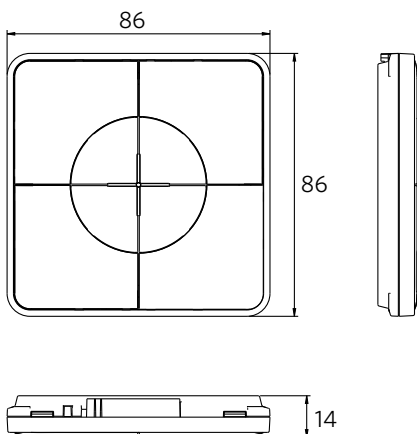

140063564 - LEDSmartlight-Switch

Can be installed using the supplied screws or affixing strips, or directly to the wall socket.





Smart Relay

- Smart Relay for use in the OPPLE Smart Lighting System
- Simple wireless control of each type/brand of luminaire
- Compatible with OPPLE Smart Sensors and OPPLE Smart Switches
- Very easy to set up with the OPPLE Smart Lighting App, Smart Connect Box or Smart Web Interface
- Including built-in energy meter, to read out in the app or web user interface
- Complete wireless communication via Bluetooth® Low Energy (BLE)
- Also suitable for control of Class I luminaires



Specifications

Item Code	Item Description
506006003100	LEDSmart-Relay-500W

Technical Specifications	
IP-class	IP20
Protection Class	II
Finishing	White RAL9003
Communication	Opplé Bluetooth® Low Energy Mesh
Max. switching capacity	500 W LED
Max. load	500 W

Electrical Supply	
Nominal voltage	220-240 V AC
Max. inrush or surge current I _p (20 ms)	120 A
Frequency	50/60 Hz
Connection cable	0.75-2.5mm ²



Mechanical Properties	
Material housing	PC

Ambient conditions	
Application Temperature	+25°C

Dimensional drawing (mm)

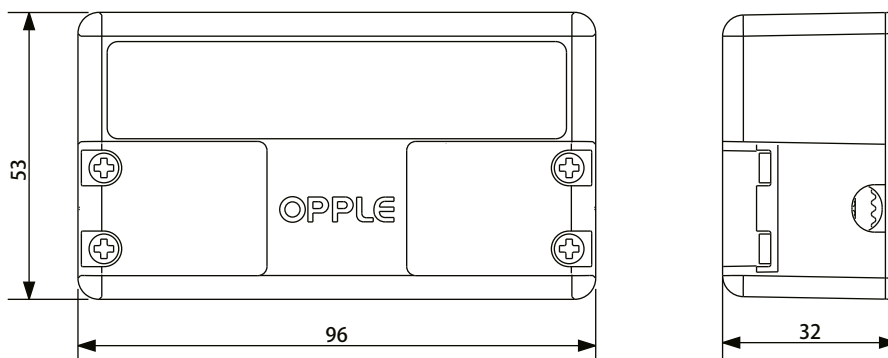

506006003100 - LEDSmart-Relay-500W





- Smart Relay with DIM function for use in the OPPLE Smart Lighting System
- Simple wireless control, including TRIAC dimming to dim any type/brand of luminaire
- Compatible with OPPLE Smart Sensors & OPPLE Smart Switch
- Including built-in energy meter, to read out in the app or web user interface
- Complete wireless communication via Bluetooth® Low Energy (BLE)



Specifications

Item Code	Item Description
821017001200	LEDSmart-BLE-Relay-250W-DIM

Technical Specifications	
IP-class	IP20
Protection	II
Finishing	White RAL9003
Communication	Opplé Bluetooth® Low Energy Mesh
Dimming method	Triac
Max. switching capacity	250 W LED
Max. load	250 W

Mechanical Properties	
Material housing	PC

Electrical Supply	
Nominal voltage	220-240 V AC
Frequency	50 Hz
Connection cable	0.75mm ²
Cable Length	12 cm

Ambient conditions	
Application Temperature	+25°C
Operating Temperature	-20-+45°C



Dimensional drawing (mm)

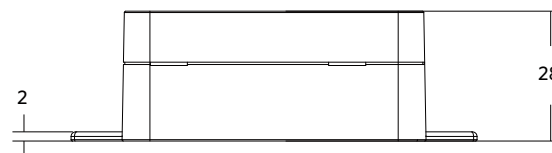
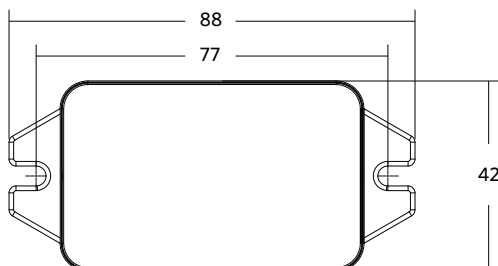



- Compact BLE to DALI converter for use in OPPLE Smart Lighting System
- Integrate any brand of DALI luminaire into the OPPLE Smart Lighting System
- Control of up to 64 DALI luminaires with Smart Switch or Smart App (DALI Broadcast commands)
- Compatible with OPPLE Smart Sensors & OPPLE Smart Switch
- Very easy to set up with the OPPLE Smart Lighting App, or Smart Connect Box through the web user interface
- Complete wireless communication via Bluetooth® Low Energy (BLE)



Specifications

Item Code	Item Description
821017001300	LEDSmart-BLE-DALI-Converter

Technical Specifications

IP-class	IP20
Protection	II
Finishing	White RAL9003
Communication	Oppl Bluetooth® Low Energy Mesh
Dimming method	DALI Broadcast
Integrated DALI power supply	Yes

Mechanical Properties

Material housing	PC
------------------	----

Electrical Supply

Nominal voltage	220-240 V AC
Frequency	50 Hz
Connection cable	0.75mm ²
Cable Length	12 cm

Ambient conditions

Application Temperature	+25°C
Operating Temperature	-20-+45°C



Dimensional drawing (mm)

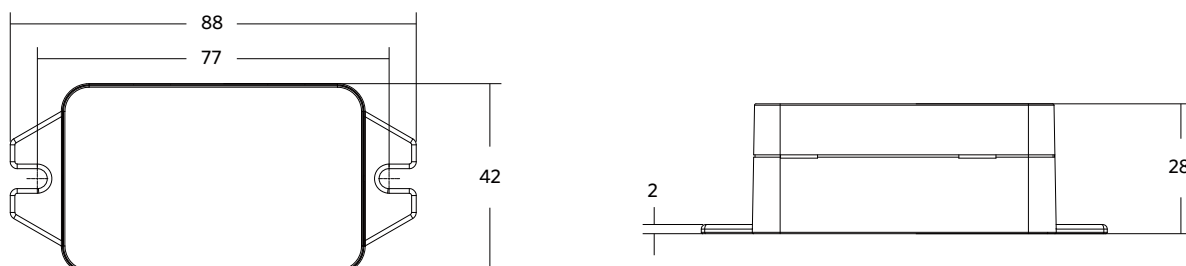

821017001300 - LEDSmart-BLE-DALI-Converter





- Compact BLE to 1-10V converter for use in OPPLE Smart Lighting System
- Integrate any brand of 1-10V luminaire into the OPPLE Smart Lighting System
- Full control of one or more 1-10V luminaires with Smart Switch or Smart App
- Compatible with OPPLE Smart Sensors & OPPLE Smart Switch
- Very easy to set up with the OPPLE Smart Lighting App, or Smart Connect Box through the web user interface
- Complete wireless communication via Bluetooth® Low Energy (BLE)



Specifications

Item Code	Item Description
821017001400	LEDSmart-BLE-10V-Converter

Technical Specifications	
IP-class	IP20
Protection	II
Finishing	White RAL9003
Communication	Opble Bluetooth® Low Energy Mesh
Dimming method	1-10V

Electrical Supply	
Nominal voltage	220-240 V AC
Frequency	50 Hz
Connection cable	0.75mm ²
Cable Length	12 cm



Mechanical Properties	
Material housing	PC

Ambient conditions	
Application Temperature	+25°C
Operating Temperature	-20-+45°C

Dimensional drawing (mm)

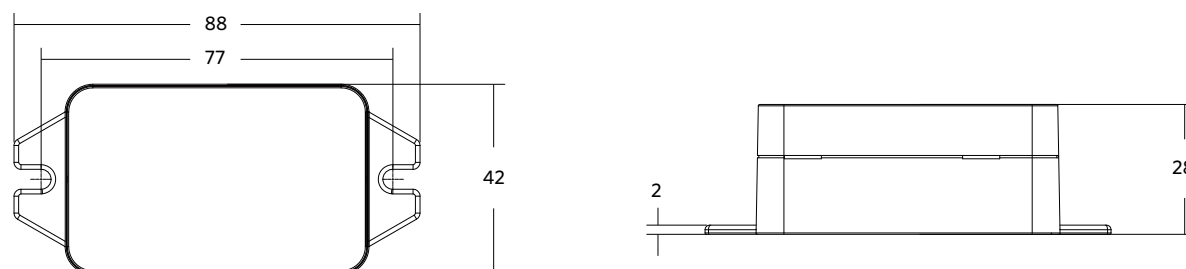

821017001400 - LEDSmart-BLE-10V-Converter







Smart 12

Indoor 30

Outdoor 120

Lamps & Tools 150

Technical Data 164

Glossary 182





Panel Grille

- Design low glare LED panel
- Direct replacement for existing T5 and T8 fixtures
- Comfortable lighting for study and work environment (UGR < 16)
- System efficacy up to 130 lm/W
- Significantly lower energy consumption up to 65%







Specifications

Item Code	Item Description	Equivalent to (W)	Power (W)	Lumen	Efficacy (lm/W)	CCT (K)	Weight (kg/pc)
DALI2							
140046181	LEDPanelRc-G Sq598-33W-DALI-3000-WH-CT	TL 4x18W	33	4200	127	3000	4.85
140046182	LEDPanelRc-G Sq598-33W-DALI-4000-WH-CT	TL 4x18W	33	4300	130	4000	4.85
140046185	LEDPanelRc-G Re298-33W-DALI-3000-WH-CT	TL 2x36W	33	4200	127	3000	5.33
140046186	LEDPanelRc-G Re298-33W-DALI-4000-WH-CT	TL 2x36W	33	4300	130	4000	4.90
Smart							
542008007900	LEDPanelRc-G Sq598-33W-BLE-3000-WH-CT	TL 4x18W	33	4200	127	3000	4.85
542008008000	LEDPanelRc-G Sq598-33W-BLE-4000-WH-CT	TL 4x18W	33	4300	130	4000	4.85
542008008100	LEDPanelRc-G Re298-33W-BLE-3000-WH-CT	TL 2x36W	33	4200	127	3000	5.33
542008008200	LEDPanelRc-G Re298-33W-BLE-4000-WH-CT	TL 2x36W	33	4300	130	4000	5.33

Available on request with Wieland GST18 or WAGO WINSTA connector, or Euro/Schuko plug. Emergency lighting available on request. BLE versions in surface mounting frames might lead to limited BLE signal strength.

Accessories

Surface Mounting Frame	Recessed Mounting Frame		
			
140044055 LEDPanelRc-G Re298-Surface Module-CT	542098009600 LEDPanelRc Sq600-Frame-WH	542098009800 LEDPanelRc Re300-Frame-WH	140060852 LEDFixture-Ceiling-Cable-Kit- 0.5m



5 YEARS WARRANTY



Technical Specifications	
Lifetime (L70)	70,000 h
Lifetime (L80)	50,000 h
On-/Off-cycles	100,000
Colour consistency (SDCM)	3
Dimmability	DALI / BLE
Beam angle	90°
Finishing	White RAL9003
Colour rendering index (CRI)	≥ 80
UGR	≤ 16
Degree of protection (IP)	IP20
Impact strength	IK02
Protection class	I
Risk group (EN 62471)	RG0
With control gear	Yes
Glow wire test	650°C
Driver failure rate (at 5,000 hrs)	<1 %
Power factor	≥ 0.9

Electrical Supply	
Frequency	50/60 Hz
Nominal voltage	220-240 V AC
DC input voltage	See catalogue appendix Connection Specifications

Mechanical Properties	
Housing material	Coated Steel
Optical material	Polycarbonate

Ambient Conditions	
Operating temperature	-10-+40°C
Application temperature	+25°C
Storage environment	-25-+50°C

Dimensional Drawing (mm)

LEDPanelRc-G Sq598

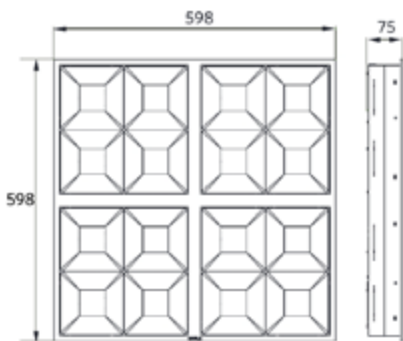

LEDPanelRc-G Re298

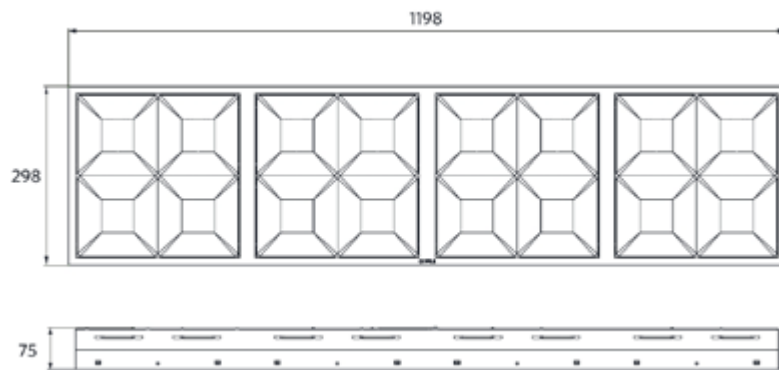



Panel Monza

- Architectural LED panel with direct/indirect light
- Unique low glare optics
- High efficacy up to 120 lm/W
- Suitable for office applications, UGR<19
- Perfect replacement of traditional CFL 55W panels - offering up to 50% energy saving
- DALI2 driver compatible with 230V push dimming



Specifications

Item Code	Item Description	Equivalent to (W)	Power (W)	Lumen	Efficacy (lm/W)	CCT (K)	Weight (kg/pc)
On-Off							
542003016800	LEDPanelRc-Mo Sq595-35W-3000-WH-U19	CFL 1x55W	35	4025	115	3000	4.18
542003016900	LEDPanelRc-Mo Sq595-35W-4000-WH-U19	CFL 1x55W	35	4200	120	4000	4.18
DALI2							
542003015200	LEDPanelRc-Mo Sq595-35W-DALI-3000-WH-U19	CFL 1x55W	35	4025	115	3000	4.22
542003015300	LEDPanelRc-Mo Sq595-35W-DALI-4000-WH-U19	CFL 1x55W	35	4200	120	4000	4.22
Smart							
542003015600	LEDPanelRc-Mo Sq595-35W-BLE-3000-WH-U19	CFL 1x55W	35	4025	115	3000	4.23
542003015700	LEDPanelRc-Mo Sq595-35W-BLE-4000-WH-U19	CFL 1x55W	35	4200	120	4000	4.23
1-10V							
542003016000	LEDPanelRc-Mo Sq595-35W-10V-3000-WH-U19	CFL 1x55W	35	4025	115	3000	4.22
542003016100	LEDPanelRc-Mo Sq595-35W-10V-4000-WH-U19	CFL 1x55W	35	4200	120	4000	4.22

Available on request with Wieland GST18 or WAGO WINSTA connector, or Euro/Schuko plug. DALI2 versions are compatible with central emergency lighting according to EN 50172.

Accessories

Recessed Mounting Frame



542098009600
LEDPanelRc Sq600-Frame-WH



542098000800
LEDPanelRC-SI U19 EM-kit 1h

542098000900
LEDPanelRC-SI U19 EM-kit 3h



140060852
LEDFixture-Ceiling-Cable-Kit-0.5m



542098030700
Junction-Box-WH



5 YEARS WARRANTY



Technical Specifications	
Lifetime (L70)	70,000 h
Lifetime (L80)	60,000 h
Lifetime (L90)	50,000 h
On-/Off-cycles	100,000
Colour consistency (SDCM)	3
Dimmability	On-Off / BLE / 1-10V / DALI2
Beam angle	90°
Finishing	White RAL9016
Colour rendering index (CRI)	≥ 80
UGR	≤ 19
Degree of protection (IP)	IP20
Impact strength	IK02
Protection class	II
Risk group (EN 62471)	RG0
With control gear	Yes
Glow wire test	650°C
Driver failure rate (at 5,000 hrs)	<1 %
Power factor	≥ 0.9

Electrical Supply	
Frequency	50/60 Hz
Nominal voltage	220-240 V AC
DC input voltage	See catalogue appendix Connection Specifications
230V Cable length	1 m

Mechanical Properties	
Housing material	Steel
Optical material	PMMA
Cover material	Polystyrene (PS)

Ambient Conditions	
Operating temperature	-10-+40°C
Application temperature	+25°C
Storage environment	-25-+50°C

Dimensional Drawing (mm)

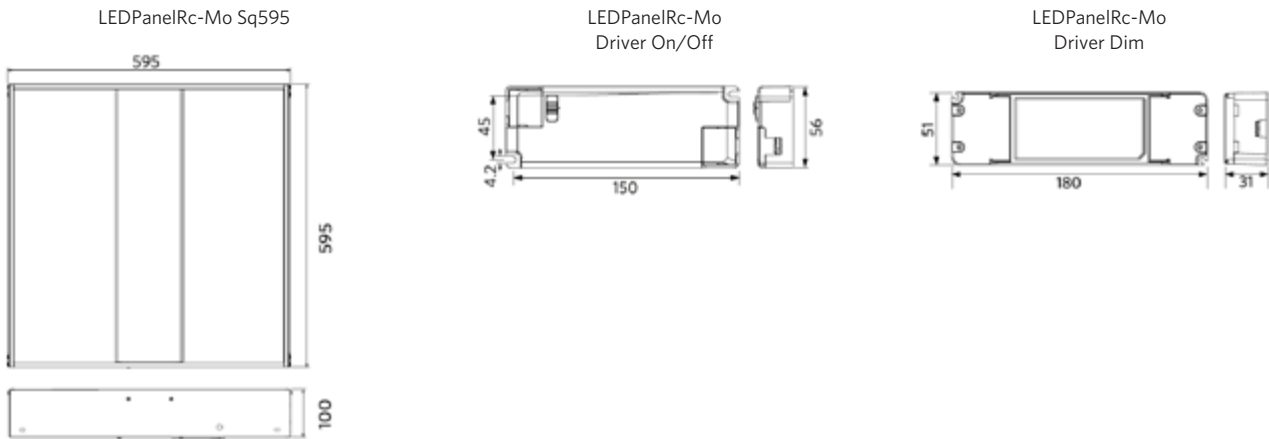



- Powerful LED panel, ideal for clutter-free ceilings
- Homogenous light distribution, with low glare optics
- Robust full metal housing
- High efficacy up to 108 lm/W
- Suitable for office applications, UGR<19
- DALI2 driver compatible with 230V push dimming



Specifications

Item Code	Item Description	Equivalent to (W)	Power (W)	Lumen	Efficacy (lm/W)	CCT (K)	Weight (kg/pc)
On-Off							
542008000900	LEDPanelRc-Sy Sq595-35W-3000-WH-U19	TL 4x18W	35	3600	103	3000	3.28
542008001000	LEDPanelRc-Sy Sq595-35W-4000-WH-U19	TL 4x18W	35	3800	108	4000	3.28
542008001100	LEDPanelRc-Sy Re295-35W-3000-WH-U19	TL 2x36W	35	3600	103	3000	3.40
542008001200	LEDPanelRc-Sy Re295-35W-4000-WH-U19	TL 2x36W	35	3800	108	4000	3.40
DALI2							
542008001300	LEDPanelRc-Sy Sq595-35W-DALI-3000-WH-U19	TL 4x18W	35	3600	103	3000	3.32
542008001400	LEDPanelRc-Sy Sq595-35W-DALI-4000-WH-U19	TL 4x18W	35	3800	108	4000	3.32
542008001500	LEDPanelRc-Sy Re295-35W-DALI-3000-WH-U19	TL 2x36W	35	3600	103	3000	3.44
542008001600	LEDPanelRc-Sy Re295-35W-DALI-4000-WH-U19	TL 2x36W	35	3800	108	4000	3.44
Smart							
542008002100	LEDPanelRc-Sy Sq595-35W-BLE-3000-WH-U19	TL 4x18W	35	3600	103	3000	3.33
542008002200	LEDPanelRc-Sy Sq595-35W-BLE-4000-WH-U19	TL 4x18W	35	3800	108	4000	3.33
542008002300	LEDPanelRc-Sy Re295-35W-BLE-3000-WH-U19	TL 2x36W	35	3600	103	3000	3.45
542008002400	LEDPanelRc-Sy Re295-35W-BLE-4000-WH-U19	TL 2x36W	35	3800	108	4000	3.45
1-10V							
542008001700	LEDPanelRc-Sy Sq595-35W-10V-3000-WH-U19	TL 4x18W	35	3600	103	3000	3.32
542008001800	LEDPanelRc-Sy Sq595-35W-10V-4000-WH-U19	TL 4x18W	35	3800	108	4000	3.32
542008001900	LEDPanelRc-Sy Re295-35W-10V-3000-WH-U19	TL 2x36W	35	3600	103	3000	3.44
542008002000	LEDPanelRc-Sy Re295-35W-10V-4000-WH-U19	TL 2x36W	35	3800	108	4000	3.44

Available on request with Wieland GST18 or WAGO WINSTA connector, or Euro/Schuko plug. DALI2 versions are compatible with central emergency lighting according to EN 50172. BLE versions in surface mounting frames might lead to limited BLE signal strength.



Accessories

Surface Mounting Frame

Recessed Mounting Frame



140055484
LEDPanelRc-Si Sq600-Surface-Module-WH-CT



140055486
LEDPanelRc-Si Re300-Surface-Module-WH-CT



542098017600
LEDPanelRc2 Sq600-Surface-Kit-WH



542098017700
LEDPanelRc2 Re300-Surface-Kit-WH



542098009600
LEDPanelRc Sq600-Frame-WH



542098009800
LEDPanelRc Re300-Frame-WH



140053150
LEDPanelRc-Si-E Mounting-Springs



140055365
LEDPanel-Si-E Suspension-Kit



542098000800
LEDPanelRC-Si U19 EM-kit 1h



140060852
LEDFixture-Ceiling-Cable-Kit-0.5m



542098030700
Junction-Box-WH

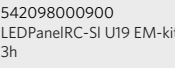

542098000900
LEDPanelRC-Si U19 EM-kit 3h

Technical Specifications

Lifetime (L70)	70,000 h
Lifetime (L80)	50,000 h
On-/Off-cycles	100,000
Colour consistency (SDCM)	3
Dimmability	On-Off / BLE / 1-10V / DALI2
Beam angle	80°
Finishing	White RAL9003
Colour rendering index (CRI)	≥ 80
UGR	≤ 19
Degree of protection (IP)	IP20
Impact strength	IK02
Protection class	II
Risk group (EN 62471)	RG0
With control gear	Yes
Glow wire test	850°C
Driver failure rate (at 5,000 hrs)	<1%
Power factor	≥ 0.9

Electrical Supply

Frequency	50/60 Hz
Nominal voltage	220-240 V AC
DC input voltage	See catalogue appendix Connection Specifications
230V Cable length	1 m

Mechanical Properties

Housing material	Steel
Optical material	Polycarbonate

Ambient Conditions

Operating temperature	-10--+40°C
Application temperature	+25°C
Storage environment	-25--+50°C



Dimensional Drawing (mm)

LEDPanelRc-Sy Sq595

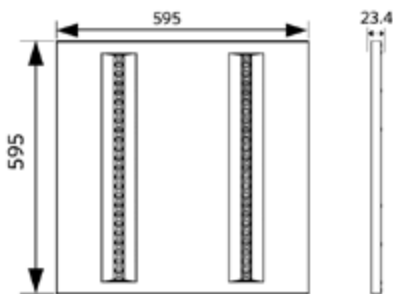

LEDPanelRc-Sy Re295

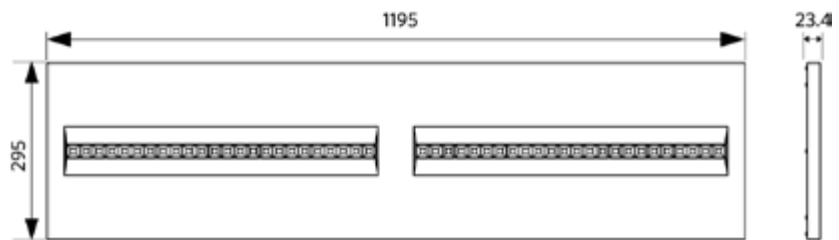

LEDPanelRc-Sy Driver On/Off

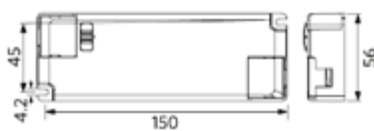

LEDPanelRc-Sy Driver Dim





Slim Panel Performer UGR19 G5

- High quality LED Slim Panel, suitable for offices (UGR19)
- Tunable white Smart version available (2700-6500K)
- Improved output up to 4420lm
- Standard IP54 (front side) (except Tunable white versions)
- Selectable light output on driver (except Bluetooth versions)
- Recessed, suspended and surface mounting possible
- Up to 60% lower energy consumption vs TL
- DALI2 driver compatible with 230V push dimming

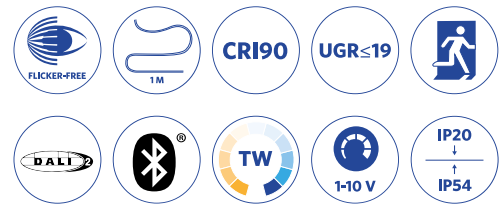

Specifications

Item Code	Item Description	Equivalent to (W)	Power (W)	Lumen	Efficacy (lm/W)	CCT (K)	Colour rendering index (CRI)	Weight (kg/pc)
On-Off								
542004068200	LEDPanelRc-S5 Sq595-30W-830-U19	TL 4x18W	30	3750	125	3000	≥ 80	2.49
542004068300	LEDPanelRc-S5 Sq595-30W-840-U19	TL 4x18W	30	3900	130	4000	≥ 80	2.49
542004068400	LEDPanelRc-S5 Re295-30W-830-U19	TL 2x36W	30	3750	125	3000	≥ 80	2.46
542004068500	LEDPanelRc-S5 Re295-30W-840-U19	TL 2x36W	30	3900	130	4000	≥ 80	2.46
542004071000	LEDPanelRc-S5 Sq595-34W-830-U19	TL 4x18W	34	4250	125	3000	≥ 80	2.49
542004071100	LEDPanelRc-S5 Sq595-34W-840-U19	TL 4x18W	34	4420	130	4000	≥ 80	2.49
542004074600	LEDPanelRc-S5 Sq595-34W-940-U19	TL 4x18W	34	3910	115	4000	≥ 90	2.49
542004071200	LEDPanelRc-S5 Re295-34W-830-U19	TL 2x36W	34	4250	125	3000	≥ 80	2.46
542004071300	LEDPanelRc-S5 Re295-34W-840-U19	TL 2x36W	34	4420	130	4000	≥ 80	2.46
542004074800	LEDPanelRc-S5 Re295-34W-940-U19	TL 2x36W	34	3910	115	4000	≥ 90	2.46
DALI2								
542004068900	LEDPanelRc-S5 Sq595-30W-DALI-830-U19	TL 4x18W	30	3750	125	3000	≥ 80	2.49
542004069000	LEDPanelRc-S5 Sq595-30W-DALI-840-U19	TL 4x18W	30	3900	130	4000	≥ 80	2.49
542004069100	LEDPanelRc-S5 Re295-30W-DALI-830-U19	TL 2x36W	30	3750	125	3000	≥ 80	2.46
542004069200	LEDPanelRc-S5 Re295-30W-DALI-840-U19	TL 2x36W	30	3900	130	4000	≥ 80	2.46



Item Code	Item Description	Equivalent to (W)	Power (W)	Lumen	Efficacy (lm/W)	CCT (K)	Colour rendering index (CRI)	Weight (kg/pc)
DALI2								
542004071700	LEDPanelRc-S5 Sq595-34W-DALI-830-U19	TL 4x18W	34	4250	125	3000	≥ 80	2.49
542004071800	LEDPanelRc-S5 Sq595-34W-DALI-840-U19	TL 4x18W	34	4420	130	4000	≥ 80	2.49
542004075200	LEDPanelRc-S5 Sq595-34W-DALI-940-U19	TL 4x18W	34	3910	115	4000	≥ 90	2.49
542004071900	LEDPanelRc-S5 Re295-34W-DALI-830-U19	TL 2x36W	34	4250	125	3000	≥ 80	2.46
542004072000	LEDPanelRc-S5 Re295-34W-DALI-840-U19	TL 2x36W	34	4420	130	4000	≥ 80	2.46
542004075400	LEDPanelRc-S5 Re295-34W-DALI-940-U19	TL 2x36W	34	3910	115	4000	≥ 90	2.46
Smart								
542004069600	LEDPanelRc-S5 Sq595-30W-BLE-830-U19	TL 4x18W	30	3750	125	3000	≥ 80	2.49
542004069700	LEDPanelRc-S5 Sq595-30W-BLE-840-U19	TL 4x18W	30	3900	130	4000	≥ 80	2.49
542004069800	LEDPanelRc-S5 Re295-30W-BLE-830-U19	TL 2x36W	30	3750	125	3000	≥ 80	2.46
542004069900	LEDPanelRc-S5 Re295-30W-BLE-840-U19	TL 2x36W	30	3900	130	4000	≥ 80	2.46
542004072400	LEDPanelRc-S5 Sq595-34W-BLE-830-U19	TL 4x18W	34	4250	125	3000	≥ 80	2.49
542004072500	LEDPanelRc-S5 Sq595-34W-BLE-840-U19	TL 4x18W	34	4420	130	4000	≥ 80	2.49
542004075800	LEDPanelRc-S5 Sq595-34W-BLE-940-U19	TL 4x18W	34	3910	115	4000	≥ 90	2.49
542004072600	LEDPanelRc-S5 Re295-34W-BLE-830-U19	TL 2x36W	34	4250	125	3000	≥ 80	2.46
542004072700	LEDPanelRc-S5 Re295-34W-BLE-840-U19	TL 2x36W	34	4420	130	4000	≥ 80	2.46
542004076000	LEDPanelRc-S5 Re295-34W-BLE-940-U19	TL 2x36W	34	3910	115	4000	≥ 90	2.46
Smart Tunable White								
542004067600	LEDPanelRc-S5 Sq595-34W-BLE-TW-U19	TL 4x18W	34	4100	120	2700-6500	≥ 80	2.49
1-10V								
542004070300	LEDPanelRc-S5 Sq595-30W-10V-830-U19	TL 4x18W	30	3750	125	3000	≥ 80	2.49
542004070400	LEDPanelRc-S5 Sq595-30W-10V-840-U19	TL 4x18W	30	3900	130	4000	≥ 80	2.49
542004070500	LEDPanelRc-S5 Re295-30W-10V-830-U19	TL 2x36W	30	3750	125	3000	≥ 80	2.46
542004070600	LEDPanelRc-S5 Re295-30W-10V-840-U19	TL 2x36W	30	3900	130	4000	≥ 80	2.46
542004073100	LEDPanelRc-S5 Sq595-34W-10V-830-U19	TL 4x18W	34	4250	125	3000	≥ 80	2.49
542004073200	LEDPanelRc-S5 Sq595-34W-10V-840-U19	TL 4x18W	34	4420	130	4000	≥ 80	2.49
542004076400	LEDPanelRc-S5 Sq595-34W-10V-940-U19	TL 4x18W	34	3910	115	4000	≥ 90	2.49
542004073300	LEDPanelRc-S5 Re295-34W-10V-830-U19	TL 2x36W	34	4250	125	3000	≥ 80	2.46
542004073400	LEDPanelRc-S5 Re295-34W-10V-840-U19	TL 2x36W	34	4420	130	4000	≥ 80	2.46
542004076600	LEDPanelRc-S5 Re295-34W-10V-940-U19	TL 2x36W	34	3910	115	4000	≥ 90	2.46

Available on request with Wieland GST18 or WAGO WINSTA connector, or Euro/Schuko plug. DALI2 versions are compatible with central emergency lighting according to EN 50172. BLE versions in surface mounting frames might lead to limited BLE signal strength.

Accessories

Surface Mounting Frame			Recessed Mounting Frame		
					
140055484 LEDPanelRc-SI Sq600-Surface-Module-WH-CT	140055486 LEDPanelRc-SI Re300-Surface-Module-WH-CT	542098017600 LEDPanelRc2 Sq600-Surface-Kit-WH	542098017700 LEDPanelRc2 Re300-Surface-Kit-WH	542098009600 LEDPanelRc Sq600-Frame-WH	542098009800 LEDPanelRc Re300-Frame-WH
					
140057770 LEDPanelRc-SI Mounting-Springs-595	542098006900 LEDPanel-S4 Suspension-Kit	542098000800 LEDPanelRc-SI U19 EM-kit 1h	140060852 LEDFixture-Ceiling-Cable-Kit-0.5m	542098030700 Junction-Box-WH	
		542098000900 LEDPanelRc-SI U19 EM-kit 3h			

5 YEARS WARRANTY



Technical Specifications	
Lifetime (L70)	100,000 h
Lifetime (L80)	70,000 h
Lifetime (L90)	50,000 h
On-/Off-cycles	100,000
Colour consistency (SDCM)	3
Dimmability	On-Off / DALI / BLE / 1-10V
Beam angle	85°
Finishing	White RAL9003
UGR	≤ 19
IP front side	IP20 (TW) / IP54
IP recessed part	IP20
Impact strength	IK04
Protection class	II
Risk group (EN 62471)	RG0
With control gear	Yes
Glow wire test	650°C
Driver failure rate (at 5,000 hrs)	<1 %
Power factor	≥ 0.9

Electrical Supply	
Frequency	50/60 Hz
Nominal voltage	220-240 V AC
DC input voltage	See catalogue appendix Connection Specifications
230V Cable length	1 m

Mechanical Properties	
Housing material	Aluminium
Optical material	PMMA
Cover material	Polystyrene (PS)

Ambient Conditions	
Operating temperature	-20-+40°C
Application temperature	+25°C
Storage environment	-25-+50°C

Dimensional Drawing (mm)

LEDPanelRc-S5 Sq595

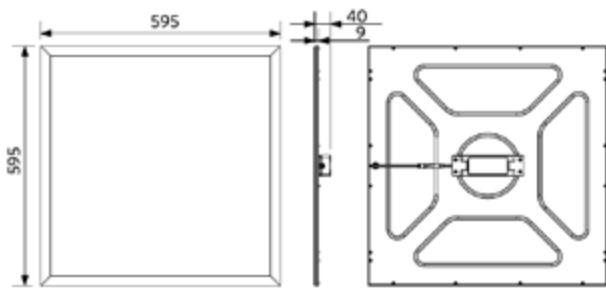

LEDPanelRc-S5 Re295

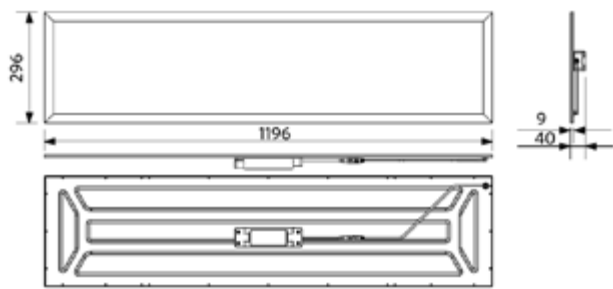

LEDPanelRc-S5
Driver On/Off



LEDPanelRc-S5
Driver Dim



LEDPanelRc-S5
Driver Tunable White







Slim Panel EcoMax G4

- LED Slim Panel, suitable for offices (UGR19)
- DALI2 dimmable versions available
- Improved efficacy up to 130lm/W
- Suitable for recessed and suspended applications
- Recessed ceiling frame and surface module kit available as accessory



Specifications

Item Code	Item Description	Equivalent to (W)	Power (W)	Lumen	Efficacy (lm/W)	CCT (K)	Weight (kg/pc)
On-Off							
542003098500	LEDPanelS-E4 Sq595-32W-830-U19	TL 4x18W	32	4000	125	3000	1.91
542003098600	LEDPanelS-E4 Sq595-32W-840-U19	TL 4x18W	32	4100	130	4000	1.91
542003098900	LEDPanelS-E4 Re295-32W-830-U19	TL 2x36W	32	4000	125	3000	1.82
542003099000	LEDPanelS-E4 Re295-32W-840-U19	TL 2x36W	32	4100	130	4000	1.82
DALI2							
542003099100	LEDPanelS-E4 Sq595-32W-DALI-830-U19	TL 4x18W	32	4000	125	3000	1.98
542003099200	LEDPanelS-E4 Sq595-32W-DALI-840-U19	TL 4x18W	32	4100	130	4000	1.98
542003099500	LEDPanelS-E4 Re295-32W-DALI-830-U19	TL 2x36W	32	4000	125	3000	1.89
542003099600	LEDPanelS-E4 Re295-32W-DALI-840-U19	TL 2x36W	32	4100	130	4000	1.89

Available on request with Wieland GST18 or WAGO WINSTA connector, or Euro/Schuko plug.

Accessories

Surface Mounting Frame		Recessed Mounting Frame			
542098017600 LEDPanelRc2 Sq600-Surface-Kit-WH	542098017700 LEDPanelRc2 Re300-Surface-Kit-WH	542098009600 LEDPanelRc Sq600-Frame-WH	542098009800 LEDPanelRc Re300-Frame-WH	542003021800 LEDPanelRc-S-B2 Mounting-Springs	542098033000 LEDPanelRc-S-B2 Re298 Mounting-Springs
542003021700 LEDPanelRc-S-B2 Suspension-Kit	542098000800 LEDPanelRC-SI U19 EM-kit 1h	542098000900 LEDPanelRC-SI U19 EM-kit 3h	542098030700 Junction-Box-WH	140060852 LEDFixture-Ceiling-Cable-Kit-0.5m	



5 YEARS WARRANTY



Technical Specifications	
Lifetime (L70)	60,000 h
Lifetime (L80)	50,000 h
On-/Off-cycles	100,000
Colour consistency (SDCM)	4
Dimmability	On-Off / DALI2
Beam angle	90°
Finishing	White RAL9003
Colour rendering index (CRI)	≥ 80
UGR	≤ 19
Degree of protection (IP)	IP20
Impact strength	IK02
Protection class	II
Risk group (EN 62471)	RG0
With control gear	Yes
Glow wire test	650°C
Driver failure rate (at 5,000 hrs)	<1 %
Power factor	≥ 0.9

Electrical Supply	
Frequency	50/60 Hz
Nominal voltage	220-240 V AC
DC input voltage	See catalogue appendix Connection Specifications
230V Cable length	1 m

Mechanical Properties	
Housing material	Aluminium
Optical material	Polystyrene (PS)
Cover material	Polystyrene (PS)

Ambient Conditions	
Operating temperature	-10-+45°C
Application temperature	+25°C
Storage environment	-25-+50°C

Dimensional Drawing (mm)

LEDPanelS-E4 Sq595-32W

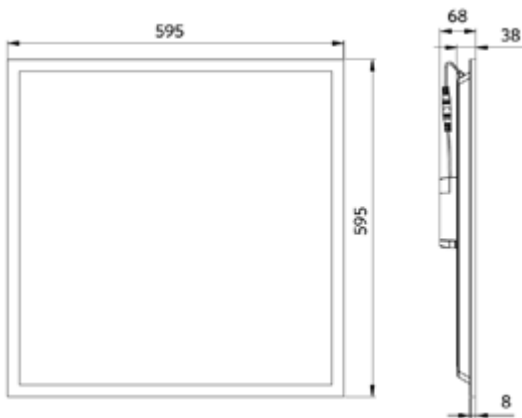

LEDPanelS-E4 Re295-32W

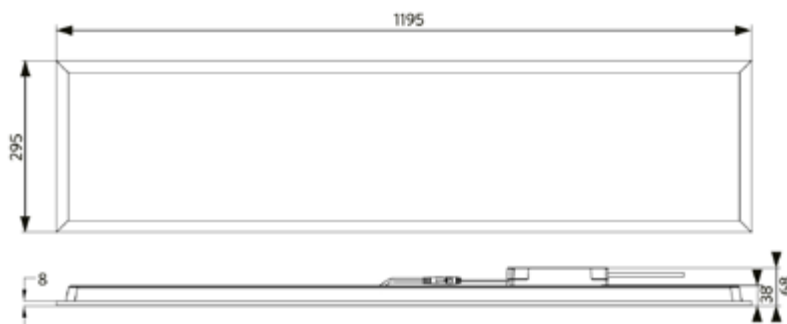

LEDPanelS-E4 Driver

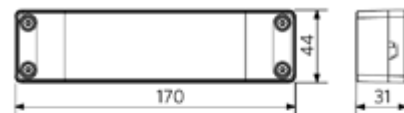



Slim Panel EcoMax UGR22 G2

- High quality LED Slim Panel
- Slim design, suitable for suspension with optional accessory
- High efficacy up to 115 lm/W
- Up to 55% lower energy consumption vs TL
- Multiple accessories available



Specifications

Item Code	Item Description	Equivalent to (W)	Power (W)	Lumen	Efficacy (lm/W)	CCT (K)	Weight (kg/pc)
On-Off							
140062700	LEDPanelRc-S-E2 Sq595-34W-3000-WH-U22	TL 4x18W	34	3700	110	3000	2.40
140062701	LEDPanelRc-S-E2 Sq595-34W-4000-WH-U22	TL 4x18W	34	3900	115	4000	2.40
140062706	LEDPanelRc-S-E2 Re295-34W-3000-WH-U22	TL 2x36W	34	3700	110	3000	2.50
140062707	LEDPanelRc-S-E2 Re295-34W-4000-WH-U22	TL 2x36W	34	3900	115	4000	2.50

Available on request with Wieland GST18 or WAGO WINSTA connector, or Euro/Schuko plug.

Accessories

Surface Mounting Frame

Recessed Mounting Frame



140055484
LEDPanelRc-SI Sq600-Surface-Module-WH-CT



140055486
LEDPanelRc-SI Re300-Surface-Module-WH-CT



542098017600
LEDPanelRc2 Sq600-Surface-Kit-WH



542098017700
LEDPanelRc2 Re300-Surface-Kit-WH



542098009600
LEDPanelRc Sq600-Frame-WH



542098009800
LEDPanelRc Re300-Frame-WH



140053150
LEDPanelRc-SI-E Mounting-Springs



140055365
LEDPanel-SI-E Suspension-Kit



542098000800
LEDPanelRC-SI U19 EM-kit 1h

542098000900
LEDPanelRC-SI U19 EM-kit 3h



140060852
LEDFixture-Ceiling-Cable-Kit-0.5m



542098030700
Junction-Box-WH



5 YEARS WARRANTY



Technical Specifications	
Lifetime (L70)	50,000 h
Lifetime (L80)	30,000 h
On-/Off-cycles	100,000
Colour consistency (SDCM)	4
Dimmability	On-Off
Beam angle	120°
Finishing	White RAL9003
Colour rendering index (CRI)	≥ 80
UGR	≤ 22
Degree of protection (IP)	IP20
Impact strength	IK02
Protection class	II
Risk group (EN 62471)	RG0
With control gear	Yes
Glow wire test	650°C
Driver failure rate (at 5,000 hrs)	<1 %
Power factor	≥ 0.9

Electrical Supply	
Frequency	50/60 Hz
Nominal voltage	220-240 V AC
DC input voltage	No
230V Cable length	1 m

Mechanical Properties	
Housing material	Aluminium
Optical material	Polystyrene (PS)
Cover material	Polycarbonate

Ambient Conditions	
Operating temperature	-10-+40°C
Application temperature	+25°C
Storage environment	-25-+50°C

Dimensional Drawing (mm)

LEDPanelRc-S-E2 Sq595

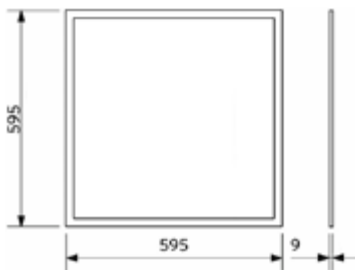

LEDPanelRc-S-E2 Re295

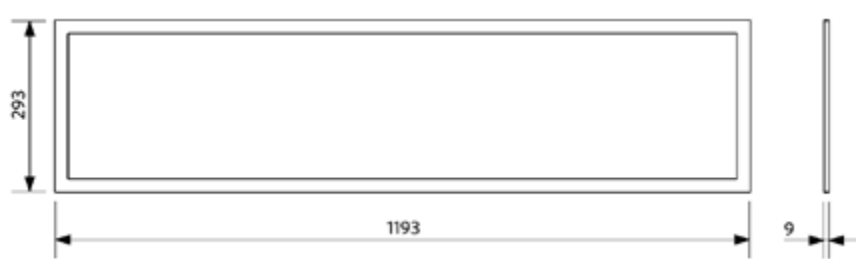

LEDPanelRc-S-E2 Driver

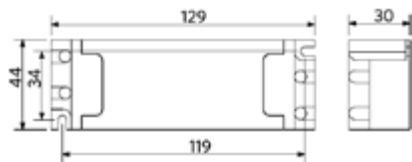



- Cost effective LED Slim Panel, available in UGR22 and UGR19
- High efficacy up to 120 lm/W
- Energy saving up to 55%
- Suitable for recessed and suspended applications
- Recessed ceiling frame and surface module kit available as accessory
- Replacement for conventional 4x18W or 2x36W luminaire



Specifications

Item Code	Item Description	Equivalent to (W)	Power (W)	Lumen	Efficacy (lm/W)	UGR	CCT (K)	Beam angle	Weight (kg/pc)
On-Off									
542003096300	LEDPanelS-B3 Sq595-32W-830-U19	TL 4x18W	32	3630	115	≤19	3000	90°	1.91
542003096400	LEDPanelS-B3 Sq595-32W-840-U19	TL 4x18W	32	3840	120	≤19	4000	90°	1.91
542003096100	LEDPanelS-B3 Sq595-32W-830	TL 4x18W	32	3630	115	≤22	3000	120°	1.51
542003096200	LEDPanelS-B3 Sq595-32W-840	TL 4x18W	32	3840	120	≤22	4000	120°	1.51
542003097100	LEDPanelS-B3 Re295-32W-830-U19	TL 2x36W	32	3630	115	≤19	3000	90°	1.82
542003097200	LEDPanelS-B3 Re295-32W-840-U19	TL 2x36W	32	3840	120	≤19	4000	90°	1.82
542003096900	LEDPanelS-B3 Re295-32W-830	TL 2x36W	32	3630	115	≤22	3000	120°	1.43
542003097000	LEDPanelS-B3 Re295-32W-840	TL 2x36W	32	3840	120	≤22	4000	120°	1.43

Accessories

Surface Mounting Frame		Recessed Mounting Frame			
542098017600 LEDPanelRc2 Sq600-Surface-Kit-WH	542098017700 LEDPanelRc2 Re300-Surface-Kit-WH	542098009600 LEDPanelRc Sq600-Frame-WH	542098009800 LEDPanelRc Re300-Frame-WH	542003021800 LEDPanelRc-S-B2 Mounting-Springs	542098033000 LEDPanelRc-S-B2 Re298 Mounting-Springs
542003021700 LEDPanelRc-S-B2 Suspension-Kit	542098030700 Junction-Box-WH	542098000800 LEDPanelRC-SI U19 EM-kit 1h	542098000900 LEDPanelRC-SI U19 EM-kit 3h	140060852 LEDFixture-Ceiling-Cable-Kit-0.5m	



3 YEARS WARRANTY



Technical Specifications

Lifetime (L70)	50,000 h
Lifetime (L80)	30,000 h
On-/Off-cycles	100,000
Colour consistency (SDCM)	5
Dimmability	On-Off
Finishing	White RAL9003
Colour rendering index (CRI)	≥ 80
Degree of protection (IP)	IP20
Impact strength	IK02
Protection class	II
Risk group (EN 62471)	RG0
With control gear	Yes
Glow wire test	650°C
Driver failure rate (at 5,000 hrs)	<1%
Power factor	≥ 0.9

Electrical Supply

Frequency	50/60 Hz
Nominal voltage	220-240 V AC
DC input voltage	See catalogue appendix Connection Specifications
230V Cable length	0.3 m

Mechanical Properties

Housing material	Aluminium
Optical material	Polystyrene (PS)
Cover material	Polystyrene (PS)

Ambient Conditions

Operating temperature	-10-+45°C
Application temperature	+25°C
Storage environment	-25-+50°C

Dimensional Drawing (mm)

LEDPanelS-B3 Sq595-32W

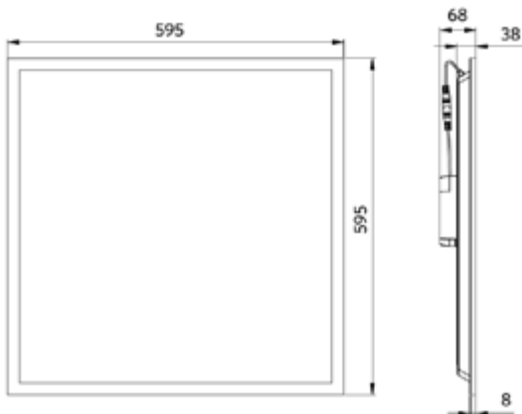

LEDPanelS-B3 Re295-32W

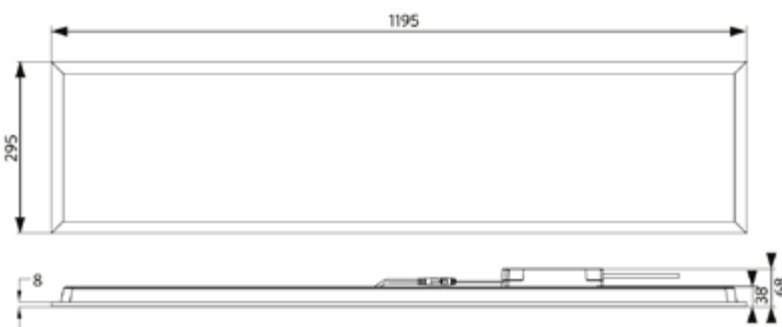

LEDPanelS-B3 Driver

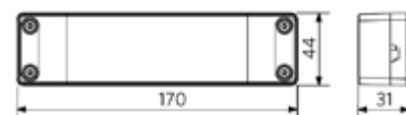



Lima

- Stylish linear luminaire with high quality aluminum housing, suitable for surface mounting and suspended use
- Suitable for use in office
- Suspension kit including transparent cable as accessory
- Connection kit accessory to create continuous lines available
- DALI or Smart Lighting (BLE) dimmable



Specifications

Item Code	Item Description	Equivalent to (W)	Power (W)	Lumen	Efficacy (lm/W)	UGR	CCT (K)	Weight (kg/pc)
DALI								
542005000500	LEDLima L12-15W-3000-U19-DALI	TL 1x28W	15	1725	115	≤19	3000	2.55
542005000600	LEDLima L12-15W-4000-U19-DALI	TL 1x28W	15	1800	120	≤19	4000	2.55
542005000700	LEDLima L15-18W-3000-U19-DALI	TL 1x35W	18	2070	115	≤19	3000	3.08
542005000800	LEDLima L15-18W-4000-U19-DALI	TL 1x35W	18	2160	120	≤19	4000	3.08
542005001300	LEDLima L12-30W-3000-DALI	TL 1x54W	30	3300	110	≤22	3000	2.55
542005001400	LEDLima L12-30W-4000-DALI	TL 1x54W	30	3450	115	≤22	4000	2.55
542005001500	LEDLima L15-36W-3000-DALI	TL 1x80W	36	3960	110	≤22	3000	3.08
542005001600	LEDLima L15-36W-4000-DALI	TL 1x80W	36	4140	115	≤22	4000	3.08
Smart								
542005004900	LEDLima L12-15W-3000-U19-BLE	TL 1x28W	15	1725	115	≤19	3000	2.55
542005004800	LEDLima L12-15W-4000-U19-BLE	TL 1x28W	15	1800	120	≤19	4000	2.55
542005004700	LEDLima L15-18W-3000-U19-BLE	TL 1x35W	18	2070	115	≤19	3000	3.08
542005004600	LEDLima L15-18W-4000-U19-BLE	TL 1x35W	18	2160	120	≤19	4000	3.08
542005004500	LEDLima L12-30W-3000-BLE	TL 1x54W	30	3300	110	≤22	3000	2.55
542005004400	LEDLima L12-30W-4000-BLE	TL 1x54W	30	3450	115	≤22	4000	2.55
542005004300	LEDLima L15-36W-3000-BLE	TL 1x80W	36	3960	110	≤22	3000	3.08
542005004200	LEDLima L15-36W-4000-BLE	TL 1x80W	36	4140	115	≤22	4000	3.08
Emergency version 1 hour, DALI								
549004002400	LEDLima L12-15W-3000-U19-DALI-EM1	TL 1x28W	15	1725	115	≤19	3000	2.85
549004002500	LEDLima L12-15W-4000-U19-DALI-EM1	TL 1x28W	15	1800	120	≤19	4000	2.85
549004002600	LEDLima L15-18W-3000-U19-DALI-EM1	TL 1x35W	18	2070	115	≤19	3000	3.38
549004002700	LEDLima L15-18W-4000-U19-DALI-EM1	TL 1x35W	18	2160	120	≤19	4000	3.38
549004002800	LEDLima L12-30W-3000-DALI-EM1	TL 1x54W	30	3300	110	≤22	3000	2.85
549004002900	LEDLima L12-30W-4000-DALI-EM1	TL 1x54W	30	3450	115	≤22	4000	2.85
549004003000	LEDLima L15-36W-3000-DALI-EM1	TL 1x80W	36	3960	110	≤22	3000	3.38
549004003100	LEDLima L15-36W-4000-DALI-EM1	TL 1x80W	36	4140	115	≤22	4000	3.38
Emergency version 3 hours, DALI								
549004003200	LEDLima L12-15W-3000-U19-DALI-EM3	TL 1x28W	15	1725	115	≤19	3000	2.95
549004003300	LEDLima L12-15W-4000-U19-DALI-EM3	TL 1x28W	15	1800	120	≤19	4000	2.95
549004003400	LEDLima L15-18W-3000-U19-DALI-EM3	TL 1x35W	18	2070	115	≤19	3000	3.48
549004003500	LEDLima L15-18W-4000-U19-DALI-EM3	TL 1x35W	18	2160	120	≤19	4000	3.48



Item Code	Item Description	Equivalent to (W)	Power (W)	Lumen	Efficacy (lm/W)	UGR	CCT (K)	Weight (kg/pc)
Emergency version 3 hours, DALI								
549004003600	LEDLima L12-30W-3000-DALI-EM3	TL 1x54W	30	3300	110	≤22	3000	2.95
549004003700	LEDLima L12-30W-4000-DALI-EM3	TL 1x54W	30	3450	115	≤22	4000	2.95
549004003800	LEDLima L15-36W-3000-DALI-EM3	TL 1x80W	36	3960	110	≤22	3000	3.48
549004003900	LEDLima L15-36W-4000-DALI-EM3	TL 1x80W	36	4140	115	≤22	4000	3.48

Accessories



599006009000
LEDLima Suspension-Kit



599006008900
LEDLima Connection-Kit

Suspension length: 1.5m.

Technical Specifications

Lifetime (L70)	70,000 h
Lifetime (L80)	50,000 h
On-/Off-cycles	100,000
Dimmability	DALI / BLE
Beam angle	70°
Finishing	Aluminum
Colour rendering index (CRI)	≥ 80
Degree of protection (IP)	IP20
Impact strength	IK02
Protection class	I
Risk group (EN 62471)	RG0
With control gear	Yes
Glow wire test	650°C
Driver failure rate (at 5,000 hrs)	<0.5 %
Power factor	≥ 0.9

Electrical Supply

Frequency	50/60 Hz
Nominal voltage	220-240 V AC
DC input voltage	See catalogue appendix Connection Specifications

Mechanical Properties

Housing material	Aluminium
Optical material	Polycarbonate

Ambient Conditions

Operating temperature	-10-+45°C
Application temperature	+25°C
Storage environment	-25-+50°C

5 YEARS WARRANTY



Dimensional Drawing (mm)

LEDLima L12

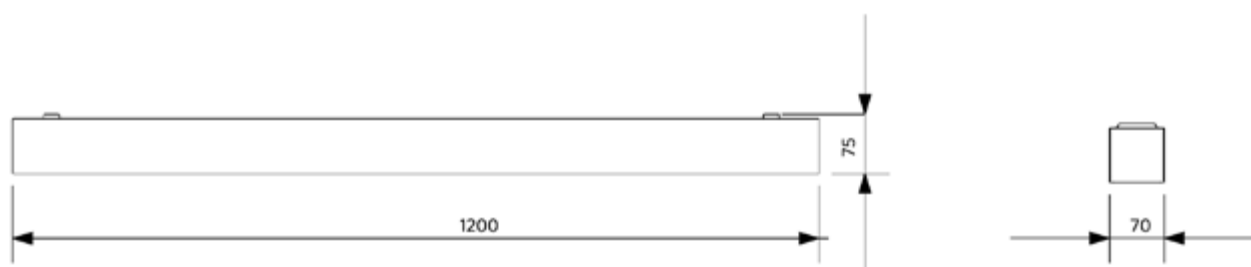

LEDLima L15





Panel Suspended Zenith

- Special design luminaire distributes light both up and down, combining comfort and efficiency
- High lumen output and high efficacy of 105 lm/W
- Light up your offices and meeting rooms in an architectural way
- Save up to 50% energy compared to fluorescent solutions
- Standard including suspension kit (2.5m) and separate aluminum colored driver housing
- DALI2 and Smart Lighting (BLE) versions available
- DALI2 driver compatible with 230V push dimming



Specifications

Item Code	Item Description	Equivalent to (W)	Power (W)	Lumen	Efficacy (lm/W)	CCT (K)	Weight (kg/pc)
DALI2							
140054053	LEDPanelSp-Z L1222-75W-DALI-3000-AL	TL 2x58W	75	7875	105	3000	3.90
140054054	LEDPanelSp-Z L1222-75W-DALI-4000-AL	TL 2x58W	75	7875	105	4000	3.90
Smart							
542006001000	LEDPanelSp-Z L1222-75W-BLE-3000-AL	TL 2x58W	75	7875	105	3000	3.90
542006000900	LEDPanelSp-Z L1222-75W-BLE-4000-AL	TL 2x58W	75	7875	105	4000	3.90

All codes include the required suspension kit. Suspension length 2.5m.
Available on request with Wieland GST18 or WAGO WINSTA connector, or Euro/Schuko plug.

Technical Specifications		Electrical Supply	
Lifetime (L70)	60,000 h	Frequency	50/60 Hz
Lifetime (L80)	40,000 h	Nominal voltage	220-240 V AC
On-/Off-cycles	100,000	DC input voltage	See catalogue appendix
Colour consistency (SDCM)	3	Connection	Specifications
Dimmability	BLE / DALI2	Mechanical Properties	
Beam angle	112° up (50%) + down (50%)	Housing material	Aluminium
Finishing	Aluminum	Optical material	PMMA
Colour rendering index (CRI)	≥ 80	Cover material	Semi-opaque PMMA
UGR	≤ 19	Ambient Conditions	
Degree of protection (IP)	IP20	Operating temperature	-20-+45°C
Impact strength	IK02	Application temperature	+25°C
Protection class	II	Storage environment	-25-+50°C
Risk group (EN 62471)	RG0		
With control gear	Yes		
Glow wire test	650°C		
Driver failure rate (at 5,000 hrs)	<1 %		
Power factor	≥ 0.9		

5 YEARS WARRANTY



Dimensional Drawing (mm)

LEDPanelSp-Z

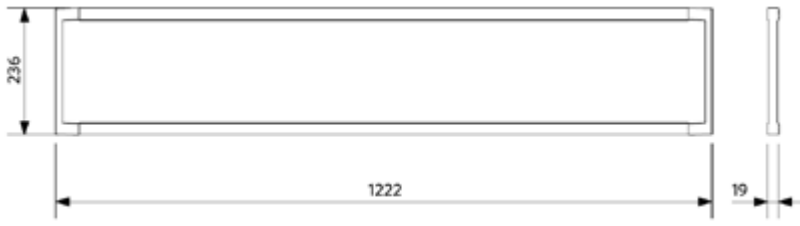

LEDPanelSp-Z
Driver

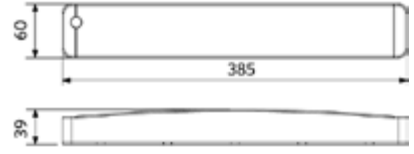



Downlight Performer HG

- Advanced high quality LED downlight
- Unique optical lens concept with high gloss (HG) reflector and low glare
- Low luminaire height (max 73mm)
- Tunable white Smart version available (2700-6500K)
- Direct replacement for compact fluorescent downlights - saving over 60% of energy costs
- IP44 on light emitting side
- Provided with protective foil in order to protect the optics against dust and dirt during the installation
- DALI2 driver compatible with 230V push dimming



Specifications

Item Code	Item Description	Equivalent to (W)	Power (W)	Lumen	Efficacy (lm/W)	UGR	CCT (K)	Colour rendering index (CRI)	Weight (kg/pc)
On-Off									
140057154	LEDDownlightRc-P-HG R150-11.5W-3000	CFL 1x18W	11.5	1240	108	≤ 19	3000	≥ 80	0.45
140057155	LEDDownlightRc-P-HG R150-11.5W-4000	CFL 1x18W	11.5	1265	110	≤ 19	4000	≥ 80	0.45
140057152	LEDDownlightRc-P-HG R200-15W-3000	CFL 1x26W	15	1620	108	≤ 19	3000	≥ 80	0.76
140057153	LEDDownlightRc-P-HG R200-15W-4000	CFL 1x26W	15	1650	110	≤ 19	4000	≥ 80	0.76
140057156	LEDDownlightRc-P-HG R200-23W-3000	CFL 2x26W	23	2480	108	≤ 19	3000	≥ 80	0.76
140057157	LEDDownlightRc-P-HG R200-23W-4000	CFL 2x26W	23	2530	110	≤ 19	4000	≥ 80	0.76
540001084000	LEDDownlightRc-P-HG R200-23W-940	CFL 2x26W	23	2530	110	≤ 19	4000	≥ 90	0.76
140057158	LEDDownlightRc-P-HG R200-33W-3000	CFL 2x32W	33	3560	108	≤ 22	3000	≥ 80	0.76
140057159	LEDDownlightRc-P-HG R200-33W-4000	CFL 2x32W	33	3630	110	≤ 22	4000	≥ 80	0.76
DALI2									
140057162	LEDDownlightRc-P-HG R150-11.5W-DALI-3000	CFL 1x18W	11.5	1240	108	≤ 19	3000	≥ 80	0.45
140057163	LEDDownlightRc-P-HG R150-11.5W-DALI-4000	CFL 1x18W	11.5	1265	110	≤ 19	4000	≥ 80	0.45
140057160	LEDDownlightRc-P-HG R200-15W-DALI-3000	CFL 1x26W	15	1620	108	≤ 19	3000	≥ 80	0.76
140057161	LEDDownlightRc-P-HG R200-15W-DALI-4000	CFL 1x26W	15	1650	110	≤ 19	4000	≥ 80	0.76
140057164	LEDDownlightRc-P-HG R200-23W-DALI-3000	CFL 2x26W	23	2480	108	≤ 19	3000	≥ 80	0.76
140057165	LEDDownlightRc-P-HG R200-23W-DALI-4000	CFL 2x26W	23	2530	110	≤ 19	4000	≥ 80	0.76
540001084800	LEDDownlightRc-P-HG R200-23W-DALI-940	CFL 2x26W	23	2530	110	≤ 19	4000	≥ 90	0.76
140057166	LEDDownlightRc-P-HG R200-33W-DALI-3000	CFL 2x32W	33	3560	108	≤ 22	3000	≥ 80	0.76
140057167	LEDDownlightRc-P-HG R200-33W-DALI-4000	CFL 2x32W	33	3630	110	≤ 22	4000	≥ 80	0.76

Item Code	Item Description	Equivalent to (W)	Power (W)	Lumen	Efficacy (lm/W)	UGR	CCT (K)	Colour rendering index (CRI)	Weight (kg/pc)
Smart									
140063611	LEDDownlightRc-P-HG R150-11.5W-BLE-3000	CFL 1x18W	11.5	1240	108	≤19	3000	≥ 80	0.53
140063612	LEDDownlightRc-P-HG R150-11.5W-BLE-4000	CFL 1x18W	11.5	1265	110	≤19	4000	≥ 80	0.53
140063613	LEDDownlightRc-P-HG R200-15W-BLE-3000	CFL 1x26W	15	1620	108	≤19	3000	≥ 80	0.84
140063614	LEDDownlightRc-P-HG R200-15W-BLE-4000	CFL 1x26W	15	1650	110	≤19	4000	≥ 80	0.84
140063615	LEDDownlightRc-P-HG R200-23W-BLE-3000	CFL 2x26W	23	2480	108	≤19	3000	≥ 80	0.84
140063616	LEDDownlightRc-P-HG R200-23W-BLE-4000	CFL 2x26W	23	2530	110	≤19	4000	≥ 80	0.84
540001085600	LEDDownlightRc-P-HG R200-23W-BLE-940	CFL 2x26W	23	2530	110	≤19	4000	≥ 90	0.84
140063617	LEDDownlightRc-P-HG R200-33W-BLE-3000	CFL 2x32W	33	3560	108	≤22	3000	≥ 80	0.84
140063618	LEDDownlightRc-P-HG R200-33W-BLE-4000	CFL 2x32W	33	3630	110	≤22	4000	≥ 80	0.84
Smart Tunable White									
540001184800	LEDDownlightRc-P-HG R200-25W-BLE-TW	CFL 2x26W	25	2650	106	≤19	2700-6500	≥ 80	0.92

Available on request with Wieland GST18 or WAGO WINSTA connector, or Euro/Schuko plug. DALI2 versions are compatible with central emergency lighting according to EN 50172.

Accessories



140060646
LEDDownlightRc-P-HZ-
Adapter-150-175



140061242
LEDDownlightRc-P-R150-
Surface-Module-WH



549098001300
LEDDownlightRc-P EM-kit 1h



542098000800
LEDPanelRC-SI U19 EM-kit 1h



542098030700
Junction-Box-WH

140060647
LEDDownlightRc-P-SI-E-
Adapter-200-225

140061243
LEDDownlightRc-P-R200-
Surface-Module-WH

549098001400
LEDDownlightRc-P EM-kit 3h

542098000900
LEDPanelRC-SI U19 EM-kit 3h

140060648
LEDDownlightRc-P-SI-E-
Adapter-200-250

See appendix Adapter Rings Overview for adapter ring dimensional drawings.

Technical Specifications

Lifetime (L70)	70,000 h
Lifetime (L80)	50,000 h
On-/Off-cycles	100,000
Colour consistency (SDCM)	3
Dimmability	On-Off / DALI / BLE
Beam angle	70°
Finishing	White RAL9003
IP front side	IP44
IP recessed part	IP20
Impact strength	IK02
Protection class	II
Risk group (EN 62471)	RG0 / RG1 (23W & 33W)
With control gear	Yes
Glow wire test	650°C
Driver failure rate (at 5,000 hrs)	<1 %
Power factor	≥ 0.9

Electrical Supply

Frequency	50/60 Hz
Nominal voltage	220-240 V AC
DC input voltage	See catalogue appendix Connection Specifications
230V Cable length	0.3 m

Mechanical Properties

Housing material	Die-casted Aluminum
Optical material	Polycarbonate

Ambient Conditions

Operating temperature	-10-+40°C
Application temperature	+25°C
Storage environment	-25-+50°C

5 YEARS WARRANTY



Dimensional Drawing (mm)

LEDDownlightRc-P-HG R150

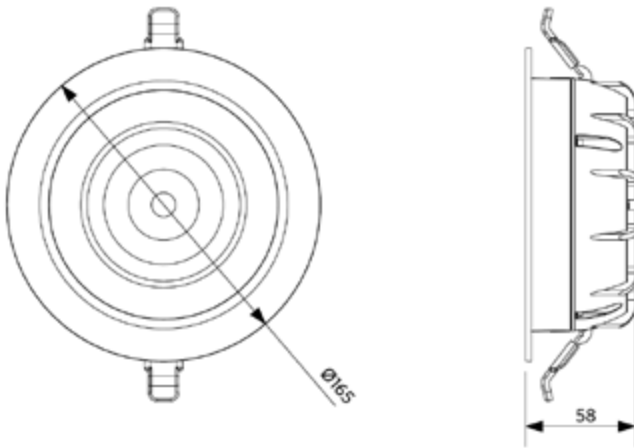

LEDDownlight Driver



LEDDownlightRc-P-HG R200

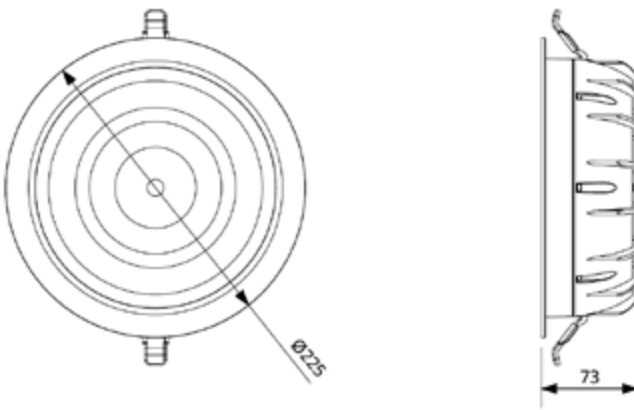

LEDDownlight Driver Tunable White

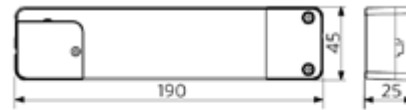

LEDDownlightRc-P-R150-Surface-Module

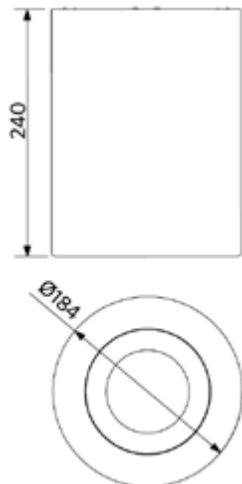

LEDDownlightRc-P-R200-Surface-Module

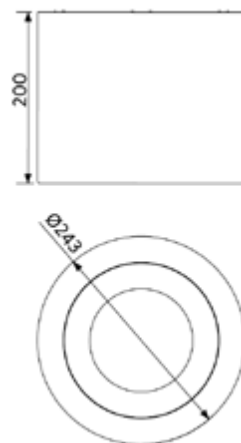

Installation Opening Drawing (mm)

LEDDownlightRc-P-HG R150
Ø150



LEDDownlightRc-P-HG R200
Ø200





SMART

INDOOR

OUTDOOR

LAMPS & TOOLS

TECHNICAL DATA

GLOSSARY





Downlight Performer MW

- NEW: High output version available (44W)
- Advanced high quality LED downlight
- Unique optical lens concept with matte white (MW) reflector and low glare
- Low luminaire height (max 73mm)
- Tunable white Smart version available (2700-6500K)
- Direct replacement for compact fluorescent downlights - saving over 60% of energy costs
- IP44 on light emitting side
- Provided with protective foil in order to protect the optics against dust and dirt during the installation
- DALI2 driver compatible with 230V push dimming



Specifications

Item Code	Item Description	Equivalent to (W)	Power (W)	Lumen	Efficacy (lm/W)	UGR	CCT (K)	Colour rendering index (CRI)	Weight (kg/pc)
On-Off									
140057170	LEDDownlightRc-P-MW R150-11.5W-3000	CFL 1x18W	11.5	1240	108	≤ 22	3000	≥ 80	0.45
140057171	LEDDownlightRc-P-MW R150-11.5W-4000	CFL 1x18W	11.5	1265	110	≤ 22	4000	≥ 80	0.45
140057168	LEDDownlightRc-P-MW R200-15W-3000	CFL 1x26W	15	1620	108	≤ 19	3000	≥ 80	0.76
140057169	LEDDownlightRc-P-MW R200-15W-4000	CFL 1x26W	15	1650	110	≤ 19	4000	≥ 80	0.76
140057172	LEDDownlightRc-P-MW R200-23W-3000	CFL 2x26W	23	2480	108	≤ 22	3000	≥ 80	0.76
140057173	LEDDownlightRc-P-MW R200-23W-4000	CFL 2x26W	23	2530	110	≤ 22	4000	≥ 80	0.76
540001086400	LEDDownlightRc-P-MW R200-23W-940	CFL 2x26W	23	2530	110	≤ 22	4000	≥ 90	0.76
140057174	LEDDownlightRc-P-MW R200-33W-3000	CFL 2x32W	33	3560	108	≤ 22	3000	≥ 80	0.76
140057175	LEDDownlightRc-P-MW R200-33W-4000	CFL 2x32W	33	3630	110	≤ 22	4000	≥ 80	0.76
540001031800	LEDDownlightRc-P-MW R200-44W-4000	HID 70W	44	5500	106	≤ 22	4000	≥ 80	0.82
DALI2									
140057178	LEDDownlightRc-P-MW R150-11.5W-DALI-3000	CFL 1x18W	11.5	1240	108	≤ 22	3000	≥ 80	0.45
140057179	LEDDownlightRc-P-MW R150-11.5W-DALI-4000	CFL 1x18W	11.5	1265	110	≤ 22	4000	≥ 80	0.45
140057176	LEDDownlightRc-P-MW R200-15W-DALI-3000	CFL 1x26W	15	1620	108	≤ 19	3000	≥ 80	0.76
140057177	LEDDownlightRc-P-MW R200-15W-DALI-4000	CFL 1x26W	15	1650	110	≤ 19	4000	≥ 80	0.76
140057180	LEDDownlightRc-P-MW R200-23W-DALI-3000	CFL 2x26W	23	2480	108	≤ 22	3000	≥ 80	0.76
140057181	LEDDownlightRc-P-MW R200-23W-DALI-4000	CFL 2x26W	23	2530	110	≤ 22	4000	≥ 80	0.76
540001087200	LEDDownlightRc-P-MW R200-23W-DALI-940	CFL 2x26W	23	2530	110	≤ 22	4000	≥ 90	0.76
140057182	LEDDownlightRc-P-MW R200-33W-DALI-3000	CFL 2x32W	33	3560	108	≤ 22	3000	≥ 80	0.76
140057183	LEDDownlightRc-P-MW R200-33W-DALI-4000	CFL 2x32W	33	3630	110	≤ 22	4000	≥ 80	0.76



Item Code	Item Description	Equivalent to (W)	Power (W)	Lumen	Efficacy (lm/W)	UGR	CCT (K)	Colour rendering index (CRI)	Weight (kg/pc)
Smart									
140063619	LEDDownlightRc-P-MW R150-11.5W-BLE-3000	CFL 1x18W	11.5	1240	108	≤22	3000	≥ 80	0.53
140063620	LEDDownlightRc-P-MW R150-11.5W-BLE-4000	CFL 1x18W	11.5	1265	110	≤22	4000	≥ 80	0.53
140063621	LEDDownlightRc-P-MW R200-15W-BLE-3000	CFL 1x26W	15	1620	108	≤19	3000	≥ 80	0.84
140063622	LEDDownlightRc-P-MW R200-15W-BLE-4000	CFL 1x26W	15	1650	110	≤19	4000	≥ 80	0.84
140063623	LEDDownlightRc-P-MW R200-23W-BLE-3000	CFL 2x26W	23	2480	108	≤22	3000	≥ 80	0.84
140063624	LEDDownlightRc-P-MW R200-23W-BLE-4000	CFL 2x26W	23	2530	110	≤22	4000	≥ 80	0.84
540001088000	LEDDownlightRc-P-MW R200-23W-BLE-940	CFL 2x26W	23	2530	110	≤22	4000	≥ 90	0.84
140063625	LEDDownlightRc-P-MW R200-33W-BLE-3000	CFL 2x32W	33	3560	108	≤22	3000	≥ 80	0.84
140063626	LEDDownlightRc-P-MW R200-33W-BLE-4000	CFL 2x32W	33	3630	110	≤22	4000	≥ 80	0.84
Smart Tunable White									
540001184900	LEDDownlightRc-P-MW R200-25W-BLE-TW	CFL 2x26W	25	2650	106	≤22	2700-6500	≥ 80	0.92

Available on request with Wieland GST18 or WAGO WINSTA connector, or Euro/Schuko plug. DALI2 versions are compatible with central emergency lighting according to EN 50172.

Accessories



140060646
LEDDownlightRc-P-HZ-Adapter-150-175



140061242
LEDDownlightRc-P-R150-Surface-Module-WH



549098001300
LEDDownlightRc-P EM-kit 1h



542098000800
LEDPanelRC-SI U19 EM-kit 1h



542098030700
Junction-Box-WH

140060647
LEDDownlightRc-P-SI-E-Adapter-200-225

140061243
LEDDownlightRc-P-R200-Surface-Module-WH

549098001400
LEDDownlightRc-P EM-kit 3h

542098000900
LEDPanelRC-SI U19 EM-kit 3h

140060648
LEDDownlightRc-P-SI-E-Adapter-200-250

See appendix Adapter Rings Overview for adapter ring dimensional drawings.

Technical Specifications		Electrical Supply	
Lifetime (L70)	70,000 h	Frequency	50/60 Hz
Lifetime (L80)	50,000 h	Nominal voltage	220-240 V AC
On-/Off-cycles	100,000	DC input voltage	See catalogue appendix Connection Specifications
Colour consistency (SDCM)	3	230V Cable length	0.3 m
Dimmability	On-Off / DALI / BLE	Mechanical Properties	
Beam angle	70°	Housing material	Die-casted Aluminum
Finishing	White RAL9003	Optical material	Polycarbonate
IP front side	IP44	Ambient Conditions	
IP recessed part	IP20	Operating temperature	-10-+40°C
Impact strength	IK02	Application temperature	+25°C
Protection class	II	Storage environment	-25-+50°C
Risk group (EN 62471)	RG0 / RG1 (23W, 33W & 44W)		
With control gear	Yes		
Glow wire test	650°C		
Driver failure rate (at 5,000 hrs)	<1 %		
Power factor	≥ 0.9		

5 YEARS WARRANTY



Dimensional Drawing (mm)

LEDDownlightRc-P-MW R150

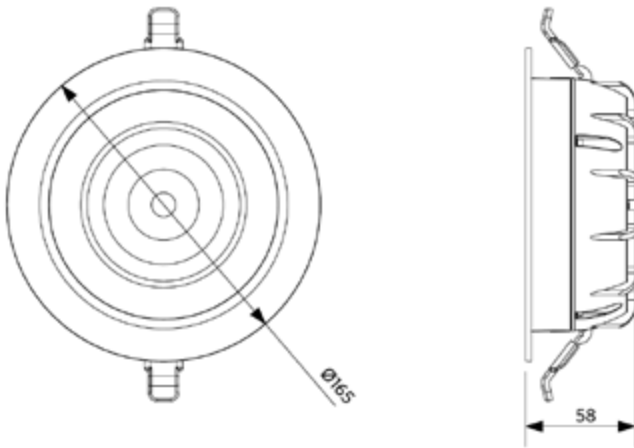

LEDDownlight Driver

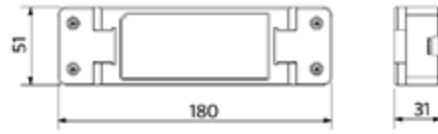

LEDDownlightRc-P-MW R200

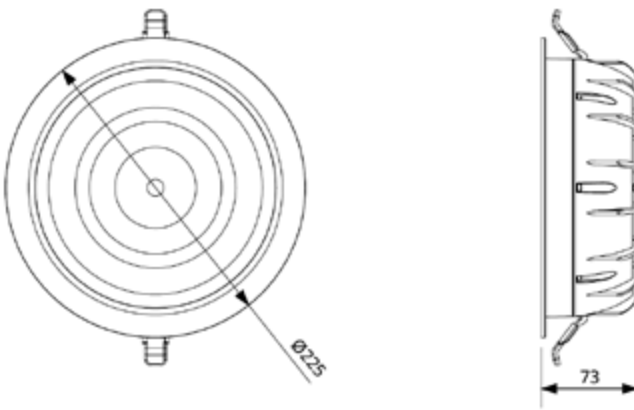

LEDDownlight Driver Tunable White

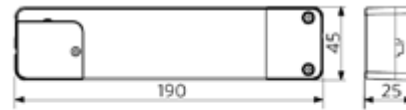

LEDDownlightRc-P-R150-Surface-Module

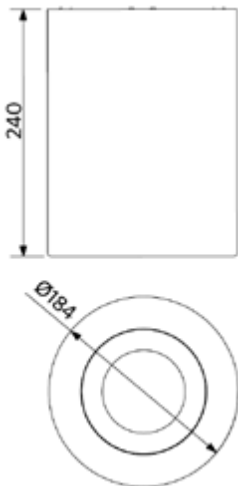

LEDDownlightRc-P-R200-Surface-Module

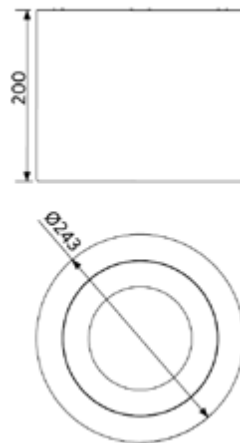

Installation Opening Drawing (mm)

LEDDownlightRc-P-MW R150
Ø150



LEDDownlightRc-P-MW R200
Ø200







Downlight Compact

- Stylish and compact LED downlight
- Sturdy full metal housing
- Integrated driver for easier installation
- Low height of only 35mm
- High efficacy up to 100 lm/W
- IP44 on light emitting side
- Full range: 4 powers and 4 sizes



Specifications

Item Code	Item Description	Equivalent to (W)	Power (W)	Lumen	Efficacy (lm/W)	CCT (K)	Weight (kg/pc)
On-Off							
540001290900	LEDDownlightCo-E Rd100-9W-830	CFL 1x18W	9	810	90	3000	0.12
540001291000	LEDDownlightCo-E Rd100-9W-840	CFL 1x18W	9	855	95	4000	0.12
540001291100	LEDDownlightCo-E Rd125-14W-830	CFL 1x26W	14	1190	85	3000	0.14
540001291200	LEDDownlightCo-E Rd125-14W-840	CFL 1x26W	14	1260	90	4000	0.14
540001291300	LEDDownlightCo-E Rd150-18W-830	CFL 1x26W	18	1620	90	3000	0.20
540001291400	LEDDownlightCo-E Rd150-18W-840	CFL 1x26W	18	1710	95	4000	0.20
540001291500	LEDDownlightCo-E Rd200-24W-830	CFL 2x26W	24	2280	95	3000	0.32
540001291600	LEDDownlightCo-E Rd200-24W-840	CFL 2x26W	24	2400	100	4000	0.32

Accessories



140060650
LEDDownlightRc-HZdim-Adapter-125-150



140060652
LEDDownlightRc-HZdim-Adapter-200-225



542098030700
Junction-Box-WH

140060646
LEDDownlightRc-P-HZ-Adapter-150-175

140060649
LEDDownlightRc-HZdim-Adapter-200-250

See appendix Adapter Rings Overview for adapter ring dimensional drawings.



5 YEARS WARRANTY



Technical Specifications	
Lifetime (L70)	50,000 h
Lifetime (L80)	30,000 h
On-/Off-cycles	100,000
Colour consistency (SDCM)	3
Dimmability	On-Off
Beam angle	100°
Finishing	White RAL9003
Colour rendering index (CRI)	≥ 80
IP front side	IP44
IP recessed part	IP20
Impact strength	IK02
Protection class	II
Risk group (EN 62471)	RG0
With control gear	Yes
Glow wire test	650°C
Driver failure rate (at 5,000 hrs)	<1 %
Displacement factor (DF)	≥ 0.9

Electrical Supply	
Frequency	50/60 Hz
Nominal voltage	220-240 V AC
DC input voltage	No
230V Cable length	0.3 m

Mechanical Properties	
Housing material	Aluminium
Optical material	Polycarbonate

Ambient Conditions	
Operating temperature	-10-+45°C
Application temperature	+25°C
Storage environment	-25-+45°C

Dimensional Drawing (mm)

LEDDownlightCo-E Rd100

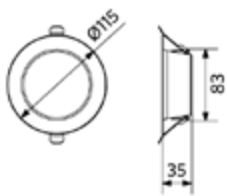

LEDDownlightCo-E Rd125

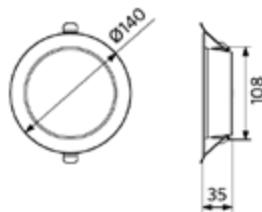

LEDDownlightCo-E Rd150

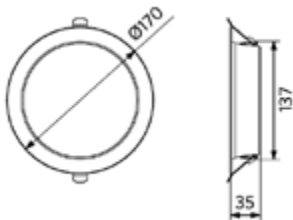

LEDDownlightCo-E Rd200

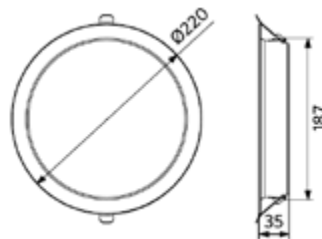

Installation Opening Drawing (mm)

LEDDownlightCo-E Rd100
Ø100



LEDDownlightCo-E Rd125
Ø125



LEDDownlightCo-E Rd150
Ø150



LEDDownlightCo-E Rd200
Ø200





Downlight Slim EcoMax

- Slim LED Downlight
- Very flat design, only 34mm height
- Available in both round and square version
- Integrated driver for easier installation
- Two lumen packages
- High efficacy of 85 lm/w
- Suitable for retrofitting due to available adapter ring sizes
- IP44 on light emitting side



Specifications

Item Code	Item Description	Equivalent to (W)	Power (W)	Lumen	Efficacy (lm/W)	CCT (K)	Weight (kg/pc)
On-Off							
140056557	LEDDownlightRc-SI-E Rd150-12W-3000-WH	CFL 1x18W	12	1020	85	3000	0.25
140056558	LEDDownlightRc-SI-E Rd150-12W-4000-WH	CFL 1x18W	12	1020	85	4000	0.25
140056559	LEDDownlightRc-SI-E Rd200-24W-3000-WH	CFL 2x26W	24	2040	85	3000	0.41
140056560	LEDDownlightRc-SI-E Rd200-24W-4000-WH	CFL 2x26W	24	2040	85	4000	0.41
140056563	LEDDownlightRc-SI-E Sq200-24W-3000-WH	CFL 2x26W	24	2040	85	3000	0.55
140056564	LEDDownlightRc-SI-E Sq200-24W-4000-WH	CFL 2x26W	24	2040	85	4000	0.55

Available on request with Wieland GST18 or WAGO WINSTA connector, or Euro/Schuko plug.

Accessories



140060653
LEDDownlightRc-SI-E-Adapter-150-175



140060647
LEDDownlightRc-P-SI-E-Adapter-200-225

140060648
LEDDownlightRc-P-SI-E-Adapter-200-250



542098030700
Junction-Box-WH

See appendix Adapter Rings Overview for adapter ring dimensional drawings.



3 YEARS WARRANTY



Technical Specifications	
Lifetime (L70)	40,000 h
Lifetime (L80)	20,000 h
On-/Off-cycles	100,000
Colour consistency (SDCM)	3
Dimmability	On-Off
Beam angle	112°
Finishing	White RAL9003
Colour rendering index (CRI)	≥ 80
IP front side	IP44
IP recessed part	IP20
Impact strength	IK02
Protection class	II
Risk group (EN 62471)	RG0
With control gear	Yes
Glow wire test	650°C
Driver failure rate (at 5,000 hrs)	<1 %
Power factor	≥ 0.9

Electrical Supply	
Frequency	50/60 Hz
Nominal voltage	220-240 V AC
DC input voltage	No
230V Cable length	0.3 m

Mechanical Properties	
Housing material	Plastic
Optical material	Polycarbonate

Ambient Conditions	
Operating temperature	-10-+40°C
Application temperature	+25°C
Storage environment	-25-+50°C

Dimensional Drawing (mm)

LEDDownlightRc-SI-E Rd150

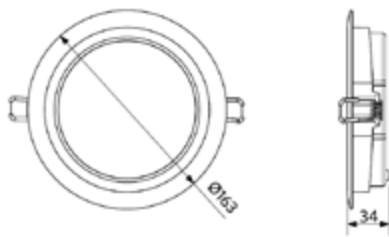

LEDDownlightRc-SI-E Rd200

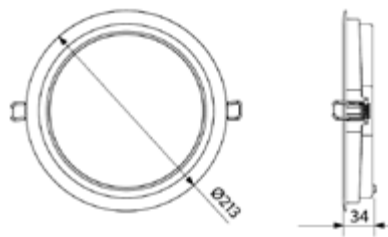

LEDDownlightRc-SI-E Sq200

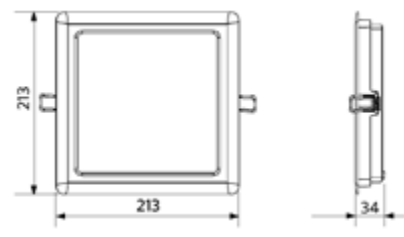

Installation Opening Drawing (mm)

LEDDownlightRc-SI-E Rd150
Ø150



LEDDownlightRc-SI-E Rd200
Ø200



LEDDownlightRc-SI-E Sq200
200 x 200





Spot Performer 3C Compact

- High performance compact track spot with high luminous efficiency and homogeneous light distribution
- Wireless dimmable Smart Lighting solution (BLE) available
- Various beam angles achievable with exchangeable reflectors
- Fitting common Global/Nordic Aluminum® 3C Tracks – and many other standard types
- Low glare due to matte black anti-glare ring
- Honeycomb filters available for further glare reduction
- Available in matte white (WH) and matte black (BL) versions



Specifications

Item Code	Item Description	Equivalent to (W)	Power (W)	Lumen	Efficacy (lm/W)	CCT (K)	Beam angle	Weight (kg/pc)
Dimmable (Triac)								
541001069000	LEDSpot3C-C-P 12W-Dim-3000-36D-WH	Halogen 100W	12	960	80	3000	36°	0.44
541001069300	LEDSpot3C-C-P 12W-Dim-4000-36D-WH	Halogen 100W	12	1020	85	4000	36°	0.44
541001069600	LEDSpot3C-C-P 12W-Dim-3000-36D-BL	Halogen 100W	12	960	80	3000	36°	0.44
541001069900	LEDSpot3C-C-P 12W-Dim-4000-36D-BL	Halogen 100W	12	1020	85	4000	36°	0.44
On-Off								
541001053900	LEDSpot3C-C-P 25W-3000-36D-WH	HID 35W	25	2125	85	3000	36°	0.74
541001053700	LEDSpot3C-C-P 25W-4000-36D-WH	HID 35W	25	2250	90	4000	36°	0.74
541001052700	LEDSpot3C-C-P 25W-3000-36D-BL	HID 35W	25	2125	85	3000	36°	0.94
541001053000	LEDSpot3C-C-P 25W-4000-36D-BL	HID 35W	25	2250	90	4000	36°	0.94
541001053500	LEDSpot3C-C-P 35W-3000-36D-WH	HID 50W	35	2975	85	3000	36°	0.94
541001053300	LEDSpot3C-C-P 35W-4000-36D-WH	HID 50W	35	3150	90	4000	36°	0.94
541001052800	LEDSpot3C-C-P 35W-3000-36D-BL	HID 50W	35	2975	85	3000	36°	0.94
541001052600	LEDSpot3C-C-P 35W-4000-36D-BL	HID 50W	35	3150	90	4000	36°	0.94
Smart								
541001094800	LEDSpot3C-C-P 37W-BLE-3000-36D-WH	HID 50W	37	2960	80	3000	36°	0.95
541001095000	LEDSpot3C-C-P 37W-BLE-4000-36D-WH	HID 50W	37	3145	85	4000	36°	0.95
541001095200	LEDSpot3C-C-P 37W-BLE-3000-36D-BL	HID 50W	37	2960	80	3000	36°	0.95
541001095400	LEDSpot3C-C-P 37W-BLE-4000-36D-BL	HID 50W	37	3145	85	4000	36°	0.95

Accessories



550098001000
LEDSpot3C-C-P R65-
Reflector-24D



550098000300
LEDSpot3C-C-P R85-
Reflector-24D



550098000500
LEDSpot3C-C-P R100-
Reflector-24D



599007083000
LEDSpot3C-C-P R65-
Honeycomb



599007082900
LEDSpot3C-C-P R85-
Honeycomb



599007082800
LEDSpot3C-C-P R100-
Honeycomb



5 YEARS WARRANTY



Technical Specifications	
Lifetime (L70)	70,000 h
Lifetime (L80)	50,000 h
On-/Off-cycles	100,000
Colour consistency (SDCM)	4
Dimmability	On-Off / Triac / BLE
Maximum tilt angle	85°
Finishing	Matte White / Matte Black
Colour rendering index (CRI)	≥ 90
Degree of protection (IP)	IP20
Impact strength	IK02 (BLE) / IK03
Protection class	II (BLE) / I
Risk group (EN 62471)	RG1
With control gear	Yes
Glow wire test	650°C
Driver failure rate (at 5,000 hrs)	<1 %
Power factor	≥ 0.9

Electrical Supply	
Frequency	50/60 Hz
Nominal voltage	220-240 V AC
DC input voltage	See catalogue appendix Connection Specifications

Mechanical Properties	
Housing material	Aluminium
Optical material	Coated Polycarbonate
Lens material	Polycarbonate

Ambient Conditions	
Operating temperature	-10-+40°C
Application temperature	+25°C
Storage environment	-25-+50°C

Dimensional Drawing (mm)

LEDspot3C-C-P 12W-Dim

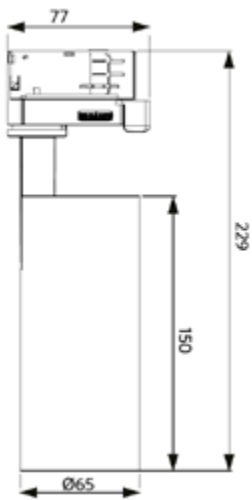

LEDspot3C-C-P 25W

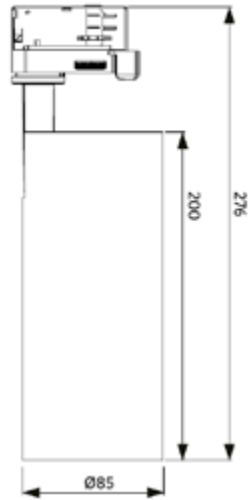

LEDspot3C-C-P 35W

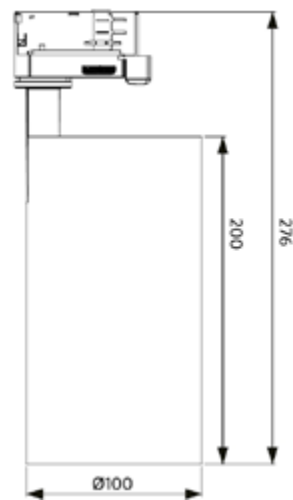

LEDspot3C-C-P 37W-BLE

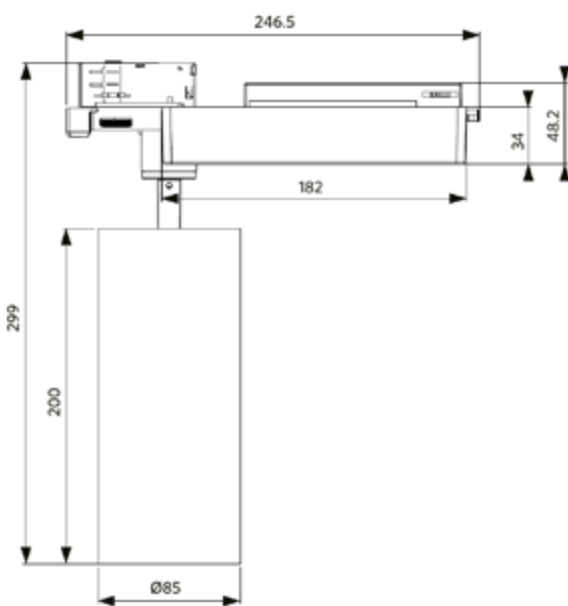



Spot Performer 3C

- Powerful track spot with attractive design with classic cylinder and box shapes that easily fits into shop architectures
- High lumen packages with high efficacy: up to 2,550 lm and 85 lm/W
- Fitting common Global/Nordic Aluminum® 3C Tracks - and many other standard types
- Low glare due to matte black anti-glare ring
- Available in matte white (WH) and matte black (BL) versions



Specifications

Item Code	Item Description	Equivalent to (W)	Power (W)	Lumen	Efficacy (lm/W)	CCT (K)	Beam angle	Weight (kg/pc)
On-Off								
140054439	LEDSpot3C-P 30W-3000-40D-WH	HID 50W	30	2400	80	3000	40°	1.20
140054447	LEDSpot3C-P 30W-4000-40D-WH	HID 50W	30	2550	85	4000	40°	1.20
140054443	LEDSpot3C-P 30W-3000-40D-BL	HID 50W	30	2400	80	3000	40°	1.20
140054451	LEDSpot3C-P 30W-4000-40D-BL	HID 50W	30	2550	85	4000	40°	1.20

Technical Specifications	
Lifetime (L70)	50,000 h
Lifetime (L80)	30,000 h
On-/Off-cycles	100,000
Colour consistency (SDCM)	3
Dimmability	On-Off
Maximum tilt angle	90°
Finishing	Matte White / Matte Black
Colour rendering index (CRI)	≥ 90
Degree of protection (IP)	IP20
Impact strength	IK02
Protection class	I
Risk group (EN 62471)	RG1
With control gear	Yes
Glow wire test	650°C
Driver failure rate (at 5,000 hrs)	<1%
Power factor	≥ 0.9

Electrical Supply	
Frequency	50/60 Hz
Nominal voltage	220-240 V AC
DC input voltage	See catalogue appendix Connection Specifications

Mechanical Properties	
Housing material	Die-casted Aluminum
Optical material	Coated Polycarbonate
Lens material	Polycarbonate

Ambient Conditions	
Operating temperature	-25-+40°C
Application temperature	+25°C
Storage environment	-25-+50°C



Dimensional Drawing (mm)

LEDspot3C-P 30W

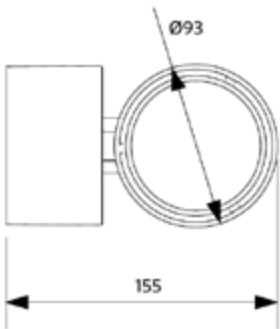
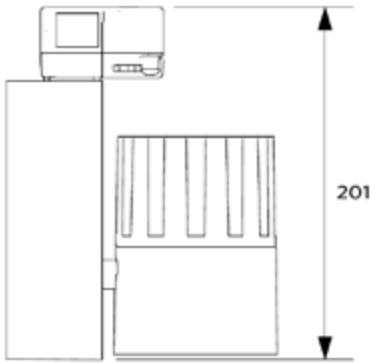



Spot EcoMax 3C



- High performance compact track spot with high luminous efficiency and homogeneous light distribution
- Simple but sleek design in cylindrical shape with no visible cooling fins
- Ideal for retail stores, showrooms, offices and homes thanks to its adjustable light head
- Fitting common Global/Nordic Aluminum® 3C Tracks - and many other standard types
- Available in matte white (WH) and matte black (BL) versions

Specifications

Item Code	Item Description	Equivalent to (W)	Power (W)	Lumen	Efficacy (lm/W)	CCT (K)	Beam angle	Weight (kg/pc)
On-Off								
541001044800	LEDSpot3C-E 30W-3000-24D-WH	HID 50W	30	2550	85	3000	24°	0.47
541001045000	LEDSpot3C-E 30W-4000-24D-WH	HID 50W	30	2700	90	4000	24°	0.47
541001044900	LEDSpot3C-E 30W-3000-24D-BL	HID 50W	30	2550	85	3000	24°	0.47
541001045100	LEDSpot3C-E 30W-4000-24D-BL	HID 50W	30	2700	90	4000	24°	0.47

Technical Specifications	
Lifetime (L70)	50,000 h
Lifetime (L80)	30,000 h
On-/Off-cycles	100,000
Colour consistency (SDCM)	3
Dimmability	On-Off
Maximum tilt angle	90°
Finishing	White / Black
Colour rendering index (CRI)	≥ 80
Degree of protection (IP)	IP20
Impact strength	IK02
Protection class	II
Risk group (EN 62471)	RG0
With control gear	Yes
Glow wire test	650°C
Driver failure rate (at 5,000 hrs)	<1 %
Power factor	≥ 0.9

Electrical Supply	
Frequency	50/60 Hz
Nominal voltage	220-240 V AC
DC input voltage	See catalogue appendix Connection Specifications

Mechanical Properties	
Housing material	Aluminium
Optical material	Coated Polycarbonate
Lens material	Polycarbonate

Ambient Conditions	
Operating temperature	-10--+40°C
Application temperature	+25°C
Storage environment	-25--+50°C

5 YEARS WARRANTY



Dimensional Drawing (mm)

LEDspot3C-E 30W

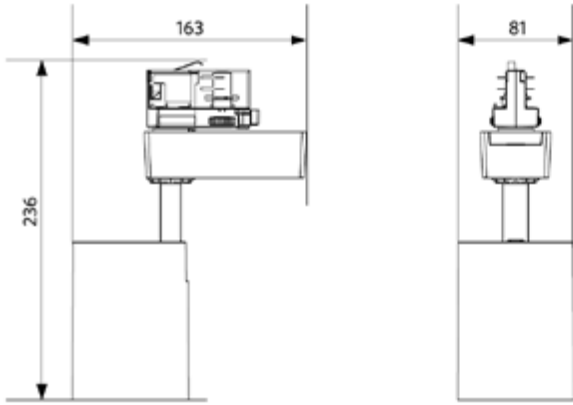



Spot Performer Swing

- Powerful recessed, rotatable and tiltable spot
- Clean and compact design ideal for retail shops, showrooms, and hospitality environments
- Die-cast aluminium housing
- Excellent colour rendering with CRI 90
- High efficiency up to 100 lm/W
- 35W version available as Smart Lighting (BLE) and DALI2 solution
- DALI2 driver compatible with 230V push dimming



Specifications

Item Code	Item Description	Equivalent to (W)	Power (W)	Lumen	Efficacy (lm/W)	CCT (K)	Beam angle	Weight (kg/pc)
On-Off								
541003067800	LEDSpotRS-P 20W-3000-60D-WH	HID 35W	20	1800	90	3000	60°	0.60
541003067900	LEDSpotRS-P 20W-4000-60D-WH	HID 35W	20	2000	100	4000	60°	0.60
541003068200	LEDSpotRS-P 35W-3000-60D-WH	HID 50W	35	3150	90	3000	60°	1.13
541003068300	LEDSpotRS-P 35W-4000-60D-WH	HID 50W	35	3500	100	4000	60°	1.13
DALI2								
541003101500	LEDSpotRS-P 35W-3000-60D-WH-DALI	HID 50W	35	3150	90	3000	60°	1.13
541003101600	LEDSpotRS-P 35W-4000-60D-WH-DALI	HID 50W	35	3500	100	4000	60°	1.13
Smart								
541003101900	LEDSpotRS-P 35W-3000-60D-WH-BLE	HID 50W	35	3150	90	3000	60°	1.13
541003102000	LEDSpotRS-P 35W-4000-60D-WH-BLE	HID 50W	35	3500	100	4000	60°	1.13
1-10V								
541003102300	LEDSpotRS-P 35W-3000-60D-WH-10V	HID 50W	35	3150	90	3000	60°	1.13
541003102400	LEDSpotRS-P 35W-4000-60D-WH-10V	HID 50W	35	3500	100	4000	60°	1.13

See appendix Adapter Rings Overview for adapter ring dimensional drawings.

Accessories



140060651
LEDDownlightRc-HZdim-Adapter-175-200



542098030700
Junction-Box-WH



5 YEARS WARRANTY



Technical Specifications	
Lifetime (L70)	70,000 h
Lifetime (L80)	50,000 h
On-/Off-cycles	100,000
Colour consistency (SDCM)	3
Dimmability	On-Off / DALI / BLE / 1-10V
Maximum tilt angle	40°
Finishing	White
Colour rendering index (CRI)	≥ 90
Degree of protection (IP)	IP20
Impact strength	IK03
Protection class	II
Risk group (EN 62471)	RG1
With control gear	Yes
Glow wire test	650°C
Driver failure rate (at 5,000 hrs)	<1 %
Power factor	≥ 0.9

Electrical Supply	
Frequency	50/60 Hz
Nominal voltage	220-240 V AC
DC input voltage	See catalogue appendix Connection Specifications
230V Cable length	0.3 m

Mechanical Properties	
Housing material	Aluminium
Optical material	Coated Polycarbonate

Ambient Conditions	
Operating temperature	-10-+45°C
Application temperature	+25°C
Storage environment	-25-+50°C

Dimensional Drawing (mm)

LEDspotRS -P 20W

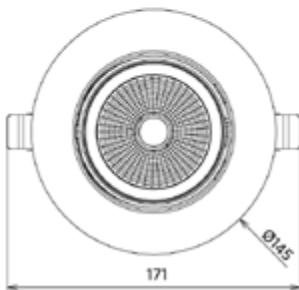
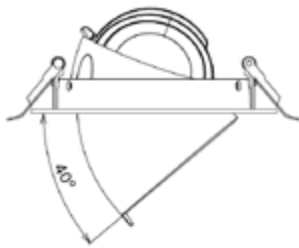

LEDspotRS -P 35W

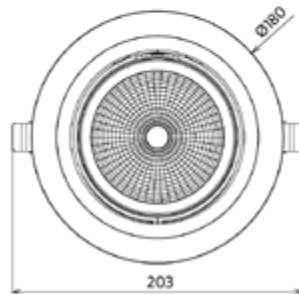
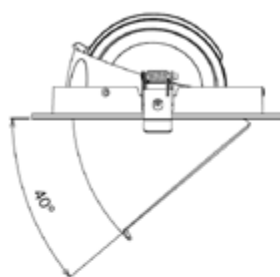

LEDspotRS -P 20W
Driver On/Off

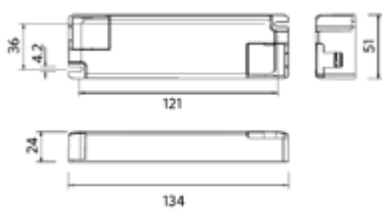

LEDspotRS -P 35W
Driver On/Off

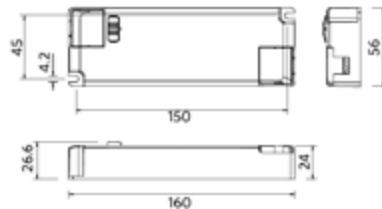

LEDspotRS -P 35W
Driver Dim

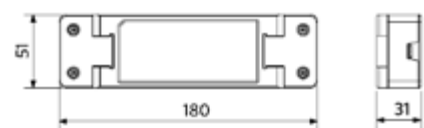

Installation Opening Drawing (mm)

LEDspotRS -P 20W
Ø120-130



LEDspotRS -P 35W
Ø160-175





Spot Round Adjustable HQ

- Attractive tiltable recessed spotlight with comfortable light beam
- Up to 85% lower energy consumption than halogen spotlights
- Unique light mixing technique and optics design, UGR16
- Good beam orientation adjustment, providing great flexibility
- Full IP44 solution (8W), including IP44 LED-driver
- Available in white and aluminum with light colors 2700K, 3000K and 4000K



Specifications

Item Code	Item Description	Equivalent to (W)	Power (W)	Lumen	Efficacy (lm/W)	CCT (K)	Degree of protection (IP)	Weight (kg/pc)
Dimmable (Triac)								
140061278	LEDSpotRA HQ2 8W-Dim-2700-40D-AL-IP44	Halogen 50W	8	640	80	2700	IP44	0.40
140061279	LEDSpotRA HQ2 8W-Dim-3000-40D-AL-IP44	Halogen 50W	8	640	80	3000	IP44	0.40
140061280	LEDSpotRA HQ2 8W-Dim-4000-40D-AL-IP44	Halogen 50W	8	680	85	4000	IP44	0.40
140061281	LEDSpotRA HQ2 8W-Dim-2700-40D-WH-IP44	Halogen 50W	8	640	80	2700	IP44	0.40
140061282	LEDSpotRA HQ2 8W-Dim-3000-40D-WH-IP44	Halogen 50W	8	640	80	3000	IP44	0.40
140061283	LEDSpotRA HQ2 8W-Dim-4000-40D-WH-IP44	Halogen 50W	8	680	85	4000	IP44	0.40

Accessories



542098030700
Junction-Box-WH



5 YEARS WARRANTY



Technical Specifications	
Lifetime (L70)	50,000 h
Lifetime (L80)	30,000 h
On-/Off-cycles	100,000
Colour consistency (SDCM)	3.4
Dimmability	Triac
Beam angle	40°
Maximum tilt angle	23°
Finishing	White RAL9003 / Brushed Aluminum RAL 9022
Colour rendering index (CRI)	≥ 80
UGR	≤ 16
Impact strength	IK02
Protection class	II
Risk group (EN 62471)	RG0
With control gear	Yes
Glow wire test	850°C
Driver failure rate (at 5,000 hrs)	<1 %
Power factor	≥ 0.9

Electrical Supply	
Frequency	50/60 Hz
Nominal voltage	220-240 V AC
DC input voltage	See catalogue appendix Connection Specifications
230V Cable length	0.3 m

Mechanical Properties	
Housing material	Aluminum + Polycarbonate
Optical material	Coated Polycarbonate

Ambient Conditions	
Operating temperature	-10-+40°C
Application temperature	+25°C
Storage environment	-25-+50°C

Dimensional Drawing (mm)

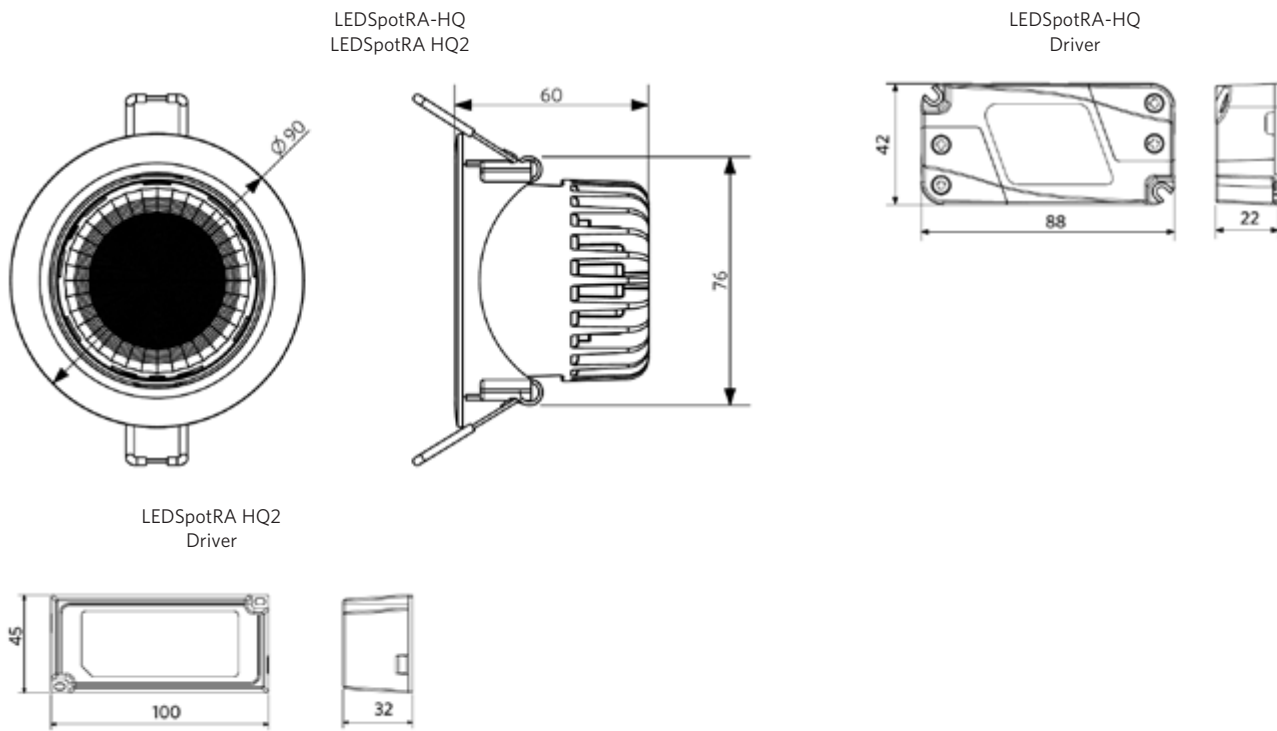

Installation Opening Drawing (mm)

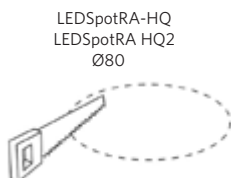



Spot Ava G2

- NEW: Available in black (BL) versions
- Modern recessed LED Spot with 25° tilting angle for perfect scene setting
- Standard fully IP44, ideal for damp applications like bathrooms
- Improved efficacy up to 77lm/W with highest light output up to 520lm
- Beam angle of 30° provides an accent lighting effect
- Comforting warm white light tone (2700K) perfect for creating cozy ambience
- Available in matte white (WH), brushed aluminium (BA) and black (BL) finishes



Specifications

Item Code	Item Description	Equivalent to (W)	Power (W)	Lumen	Efficacy (lm/W)	CCT (K)	Weight (kg/pc)
Dimmable (Triac)							
541003207300	LEDSpotRA-Ava-E2 5W-Dim-2700-30D-BA	Halogen 35W	5	385	77	2700	0.22
541003207100	LEDSpotRA-Ava-E2 5W-Dim-2700-30D-WH	Halogen 35W	5	385	77	2700	0.22
541003538200	LEDSpotRA-Ava-E2 5W-Dim-2700-30D-BL	Halogen 35W	5	385	77	2700	0.22
541003207700	LEDSpotRA-Ava-E2 7W-Dim-2700-30D-BA	Halogen 50W	7	520	74	2700	0.22
541003207500	LEDSpotRA-Ava-E2 7W-Dim-2700-30D-WH	Halogen 50W	7	520	74	2700	0.22
541003538400	LEDSpotRA-Ava-E2 7W-Dim-2700-30D-BL	Halogen 50W	7	520	74	2700	0.22

Accessories



542098030700
Junction-Box-WH



5 YEARS WARRANTY



Technical Specifications

Lifetime (L70)	50,000 h
Lifetime (L80)	30,000 h
On-/Off-cycles	100,000
Colour consistency (SDCM)	4
Dimmability	Triac
Beam angle	30°
Maximum tilt angle	25°
Finishing	Brushed Aluminum / Matte White / Black
Colour rendering index (CRI)	≥ 80
Degree of protection (IP)	IP44
Impact strength	IK02
Protection class	II
Risk group (EN 62471)	RG0
With control gear	Yes
Glow wire test	750°C
Driver failure rate (at 5,000 hrs)	<0.5 %
Power factor	≥ 0.9

Electrical Supply

Frequency	50/60 Hz
Nominal voltage	220-240 V AC
DC input voltage	No
230V Cable length	0.3 m

Mechanical Properties

Housing material	Aluminium
Optical material	Polycarbonate

Ambient Conditions

Operating temperature	-10-+45°C
Application temperature	+25°C
Storage environment	-25-+50°C

Dimensional Drawing (mm)

LEDSpotRA-Ava-E2

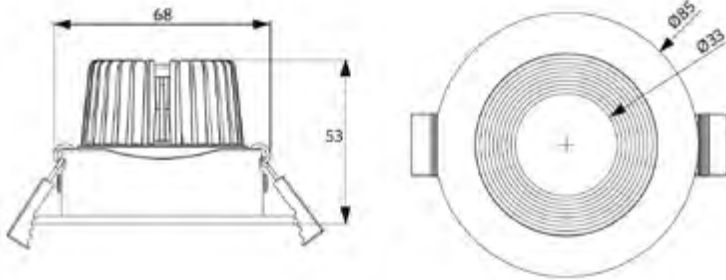

LEDSpotRA-Ava-E2 Driver

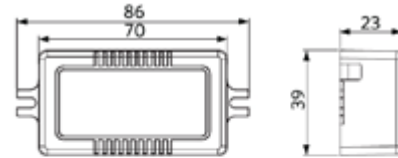

Installation Opening Drawing (mm)

LEDSpotRA-Ava-E2
Ø68-76





Spot Chiara

- Recessed LED spot with 25° tilting angle
- Clean beam thanks to newly designed micro faceted reflector
- Light free of multiple shadows for professional accent lighting
- Available in 2700K, 3000K and 4000K
- Universal cut-out of 68mm
- IP44 on the light emitting side
- Available in matte white (WH) and brushed aluminium (AL) finishes
- Over 85% savings of energy costs compared to halogen 35W and 50W



Specifications

Item Code	Item Description	Equivalent to (W)	Power (W)	Lumen	Efficacy (lm/W)	CCT (K)	Weight (kg/pc)
On-Off							
541003410800	LEDSpotRA-Chiara-E 6W-827-36D-AL	Halogen 35W	6	450	75	2700	0.09
541003410900	LEDSpotRA-Chiara-E 6W-827-36D-WH	Halogen 35W	6	450	75	2700	0.09
541003414200	LEDSpotRA-Chiara-E 6W-830-36D-AL	Halogen 35W	6	450	75	3000	0.09
541003414300	LEDSpotRA-Chiara-E 6W-830-36D-WH	Halogen 35W	6	450	75	3000	0.09
541003411000	LEDSpotRA-Chiara-E 6W-840-36D-AL	Halogen 35W	6	480	80	4000	0.09
541003411100	LEDSpotRA-Chiara-E 6W-840-36D-WH	Halogen 35W	6	480	80	4000	0.09
541003411200	LEDSpotRA-Chiara-E 8W-827-36D-AL	Halogen 50W	8	600	75	2700	0.09
541003411300	LEDSpotRA-Chiara-E 8W-827-36D-WH	Halogen 50W	8	600	75	2700	0.09
541003414400	LEDSpotRA-Chiara-E 8W-830-36D-AL	Halogen 50W	8	600	75	3000	0.09
541003414500	LEDSpotRA-Chiara-E 8W-830-36D-WH	Halogen 50W	8	600	75	3000	0.09
541003411400	LEDSpotRA-Chiara-E 8W-840-36D-AL	Halogen 50W	8	640	80	4000	0.09
541003411500	LEDSpotRA-Chiara-E 8W-840-36D-WH	Halogen 50W	8	640	80	4000	0.09

Accessories



542098030700
Junction-Box-WH



5 YEARS WARRANTY



Technical Specifications	
Lifetime (L70)	50,000 h
Lifetime (L80)	30,000 h
On-/Off-cycles	100,000
Colour consistency (SDCM)	4
Dimmability	On-Off
Beam angle	36°
Maximum tilt angle	25°
Finishing	Brushed Aluminum / Matte White
Colour rendering index (CRI)	≥ 80
IP front side	IP44
IP recessed part	IP20
Impact strength	IK02
Protection class	II
Risk group (EN 62471)	RG1
With control gear	Yes
Glow wire test	650°C
Driver failure rate (at 5,000 hrs)	<1 %
Displacement factor (DF)	≥ 0.9

Electrical Supply	
Frequency	50/60 Hz
Nominal voltage	220-240 V AC
DC input voltage	See catalogue appendix Connection Specifications
230V Cable length	0.3 m

Mechanical Properties	
Housing material	Polycarbonate (PC)
Optical material	Polycarbonate

Ambient Conditions	
Operating temperature	-10-+40°C
Application temperature	+25°C
Storage environment	-25-+50°C

Dimensional Drawing (mm)

LEDSpotRA-Chiara-E

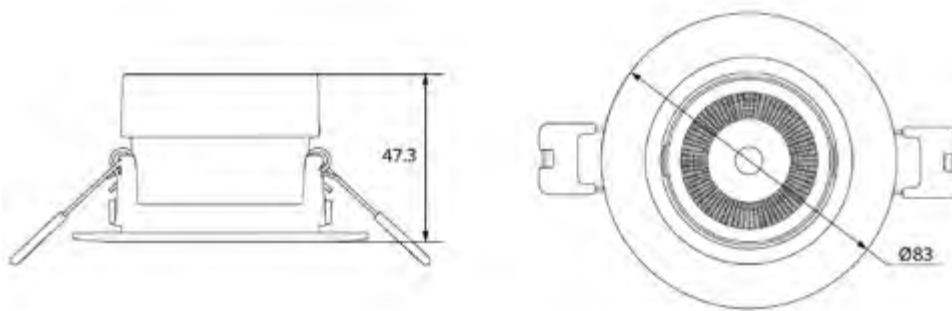

Installation Opening Drawing (mm)

LEDSpotRA-Chiara-E
Ø68-74





Wall-Mounted Performer

- Robust, waterproof IP65 LED luminaire with high degree impact protection (IK10)
- Well integrated in architecture thanks to its comfortable light distribution
- 3-step dimming functionality thanks to the integrated motion and daylight sensor (MD-versions)
- One Wall-Mounted with sensor (MD) can control up to 10 Wall-Mounted fixtures
- 1 hour and 3 hour emergency versions available (EM1/EM3)
- Integrated CCT switch for color selection (3000K-4000K)
- Designed to be easy to install and maintain with up to 2.5mm² through-wiring possibility
- Suitable for both indoor and outdoor applications
- Energy savings up to 60% compared to compact fluorescent based fixtures



Specifications

Item Code	Item Description	Equivalent to (W)	Power (W)	Lumen	Efficacy (lm/W)	CCT (K)	With sensor	Weight (kg/pc)
1-10V								
543011000600	LEDWall-Mounted-P Rd300-15W	CFL 2x18W	15	1750	115	3000/4000	No	1.30
543011000400	LEDWall-Mounted-P Rd300-21W	CFL 2x26W	21	2550	120	3000/4000	No	1.32
Motion Detection, Daylight Detection								
543011000500	LEDWall-Mounted-P Rd300-16W-MD	CFL 2x18W	16	1750	110	3000/4000	Yes	1.40
543011000300	LEDWall-Mounted-P Rd300-22W-MD	CFL 2x26W	22	2550	115	3000/4000	Yes	1.42
Emergency version 1 hour, 1-10V								
543011003600	LEDWall-Mounted-P Rd300-15W-EM1	CFL 2x18W	15	1750	115	3000/4000	No	1.48
543011003800	LEDWall-Mounted-P Rd300-21W-EM1	CFL 2x26W	21	2550	120	3000/4000	No	1.50
Emergency version 1 hour, Motion Detection, Daylight Detection								
543011003700	LEDWall-Mounted-P Rd300-16W-MD-EM1	CFL 2x18W	16	1750	110	3000/4000	Yes	1.58
543011003900	LEDWall-Mounted-P Rd300-22W-MD-EM1	CFL 2x26W	22	2550	115	3000/4000	Yes	1.60
Emergency version 3 hours, 1-10V								
543011003200	LEDWall-Mounted-P Rd300-15W-EM3	CFL 2x18W	15	1750	115	3000/4000	No	1.78
543011003400	LEDWall-Mounted-P Rd300-21W-EM3	CFL 2x26W	21	2550	120	3000/4000	No	1.80
Emergency version 3 hours, Motion Detection, Daylight Detection								
543011003300	LEDWall-Mounted-P Rd300-16W-MD-EM3	CFL 2x18W	16	1750	110	3000/4000	Yes	1.88
543011003500	LEDWall-Mounted-P Rd300-22W-MD-EM3	CFL 2x26W	22	2550	115	3000/4000	Yes	1.90



5 YEARS WARRANTY



Technical Specifications

Lifetime (L70)	50,000 h
Lifetime (L80)	30,000 h
On-/Off-cycles	100,000
Colour consistency (SDCM)	4
Dimmability	1-10V
Sensor type	No / Motion + Daylight detection (MD)
Sensor technology	No / Microwave
Finishing	White RAL9003
Colour rendering index (CRI)	≥ 80
Degree of protection (IP)	IP65
Impact strength	IK10
Protection class	II
Risk group (EN 62471)	RG0
With control gear	Yes
Glow wire test	850°C
Driver failure rate (at 5,000 hrs)	<0.5 %
Power factor	≥ 0.9

Electrical Supply

Frequency	50/60 Hz
Nominal voltage	220-240 V AC
DC input voltage	See catalogue appendix Connection Specifications

Mechanical Properties

Housing material	Polycarbonate (PC)
Optical material	Polycarbonate

Ambient Conditions

Operating temperature	-30-+50°C
Application temperature	+25°C
Storage environment	-30-+60°C

Dimensional Drawing (mm)

LEDWall-Mounted-P Rd300

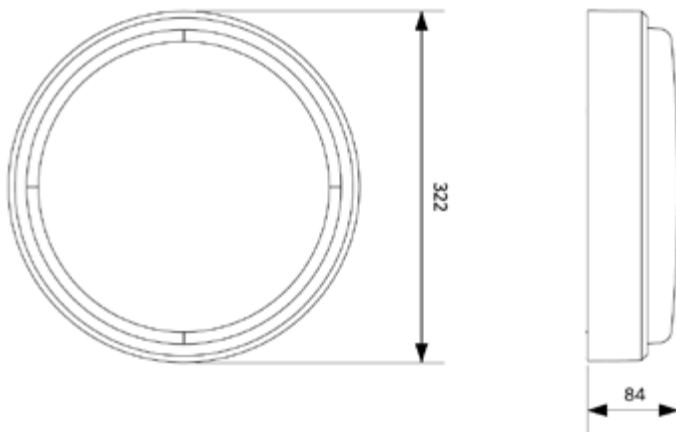

Motion sensors - Detection range

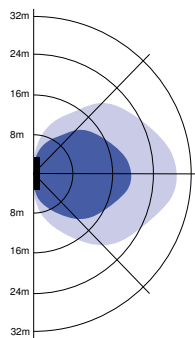

Installation - Wall mounted
Suggested installation height 1-4m

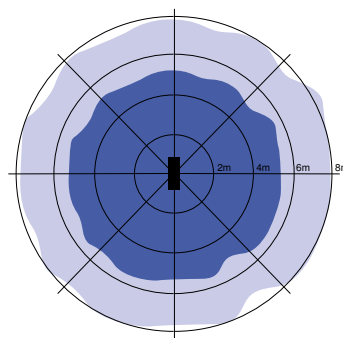

Installation - Ceiling mounted
Suggested installation height 2.5-10m

50% Sensitivity

100% Sensitivity





Wall-Mounted EcoMax G2

- Stylish, compact and sturdy wall mounted fixture (IP54+IK08)
- Easy wiring with through-wiring possibility
- Integrated CCT switch for color selection (3000K-4000K)
- Available with integrated motion & daylight sensor with 2-step dimming (MD-version)
- 3hr emergency available with auto-test functionality (EM-version)
- Energy savings up to 60% compared to compact fluorescent based fixtures



Specifications

Item Code	Item Description	Equivalent to (W)	Power (W)	Lumen	Efficacy (lm/W)	CCT (K)	With sensor	Weight (kg/pc)
On-Off								
522020001800	LEDWall-Mounted-E2 Rd275-14W	CFL 2x18W	14	1700	120	3000/4000	No	0.70
522020001600	LEDWall-Mounted-E2 Rd275-22W	CFL 2x26W	22	2500	115	3000/4000	No	0.70
Motion Detection, Daylight Detection								
522020001700	LEDWall-Mounted-E2 Rd275-14W-MD	CFL 2x18W	14	1700	120	3000/4000	Yes	0.76
522020001500	LEDWall-Mounted-E2 Rd275-22W-MD	CFL 2x26W	22	2500	115	3000/4000	Yes	0.76
Emergency version 3 hours, On-Off								
522020001400	LEDWall-Mounted-E2 Rd275-14W-EM3	CFL 2x18W	14	1700	120	3000/4000	No	0.80
522020001200	LEDWall-Mounted-E2 Rd275-22W-EM3	CFL 2x26W	22	2500	115	3000/4000	No	0.80
Emergency version 3 hours, Motion Detection, Daylight Detection								
522020001300	LEDWall-Mounted-E2 Rd275-14W-MD-EM3	CFL 2x18W	14	1700	120	3000/4000	Yes	0.86
522020001100	LEDWall-Mounted-E2 Rd275-22W-MD-EM3	CFL 2x26W	22	2500	115	3000/4000	Yes	0.86

Technical Specifications	
Lifetime (L70)	50,000 h
Lifetime (L80)	30,000 h
On-/Off-cycles	100,000
Colour consistency (SDCM)	4
Dimmability	On-Off / Sensor controlled
Sensor type	No / Motion + Daylight detection (MD)
Sensor technology	No / Microwave
Finishing	White RAL9016
Colour rendering index (CRI)	≥ 80
Degree of protection (IP)	IP54
Impact strength	IK08
Protection class	II
With control gear	Yes
Glow wire test	850°C
Driver failure rate (at 5,000 hrs)	<0.5 %
Power factor	≥ 0.9

Electrical Supply	
Frequency	50/60 Hz
Nominal voltage	220-240 V AC
DC input voltage	No

Mechanical Properties	
Housing material	Polypropylene (PP)
Optical material	Polypropylene (PP)

Ambient Conditions	
Operating temperature	-20-+45°C
Operating temperature EM	0-+45°C
Application temperature	+25°C
Storage environment	-20-+25°C
Storage environment EM	-20-+25°C

5 YEARS WARRANTY



Dimensional Drawing (mm)

LEDWall-Mounted-E2 Rd275

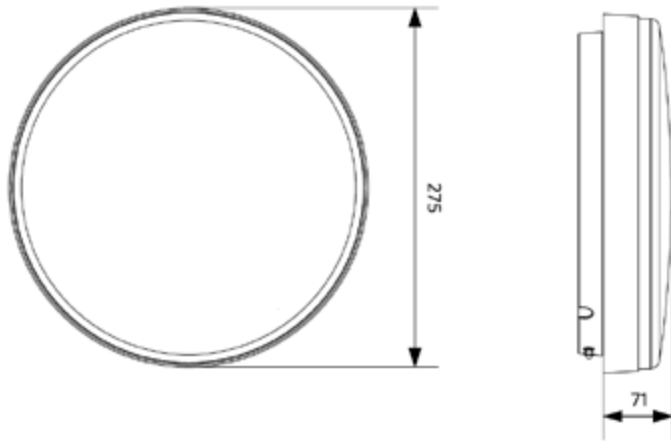

Motion sensors - Detection range

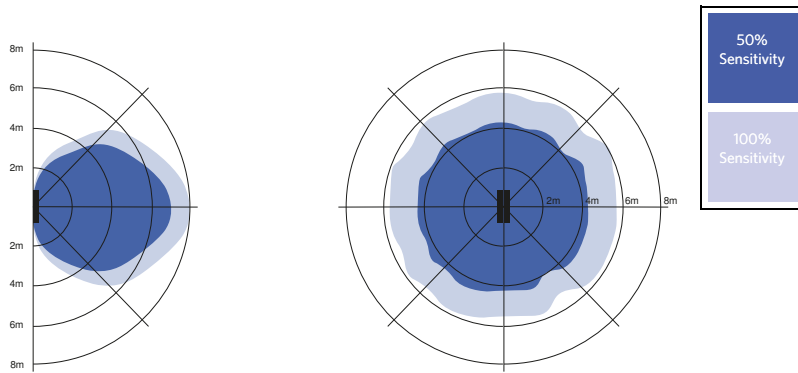

Installation - Wall mounted
Suggested installation height 1-3m

Installation - Ceiling mounted
Suggested installation height 2.5-6m





Ceiling Light Luna

- Stylish and compact ceiling luminaire
- Clean “twist-and-lock” mounting system
- High quality full metal body
- Low height of only 46mm
- High efficacy up to 95 lm/W
- Full range: 4 powers and 3 sizes
- Suitable for ceiling and wall mounting
- Available in black (BL) and white (WH)



Specifications

Item Code	Item Description	Equivalent to (W)	Power (W)	Lumen	Efficacy (lm/W)	CCT (K)	Weight (kg/pc)
On-Off							
540001295100	LEDceilingLu-E Rd87-9W-830-WH	CFL 1x18W	9	810	90	3000	0.10
540001295500	LEDceilingLu-E Rd87-9W-830-BL	CFL 1x18W	9	810	90	3000	0.10
540001296300	LEDceilingLu-E Rd87-9W-840-WH	CFL 1x18W	9	855	95	4000	0.10
540001295600	LEDceilingLu-E Rd87-9W-840-BL	CFL 1x18W	9	855	95	4000	0.10
540001295200	LEDceilingLu-E Rd112-14W-830-WH	CFL 1x26W	14	1190	85	3000	0.17
540001295700	LEDceilingLu-E Rd112-14W-830-BL	CFL 1x26W	14	1190	85	3000	0.17
540001296400	LEDceilingLu-E Rd112-14W-840-WH	CFL 1x26W	14	1260	90	4000	0.17
540001295800	LEDceilingLu-E Rd112-14W-840-BL	CFL 1x26W	14	1260	90	4000	0.17
540001295300	LEDceilingLu-E Rd142-18W-830-WH	CFL 2x18W	18	1620	90	3000	0.27
540001295900	LEDceilingLu-E Rd142-18W-830-BL	CFL 2x18W	18	1620	90	3000	0.27
540001296500	LEDceilingLu-E Rd142-18W-840-WH	CFL 2x18W	18	1710	95	4000	0.27
540001296000	LEDceilingLu-E Rd142-18W-840-BL	CFL 2x18W	18	1710	95	4000	0.27
540001295400	LEDceilingLu-E Rd142-24W-830-WH	CFL 2x26W	24	2040	85	3000	0.27
540001296100	LEDceilingLu-E Rd142-24W-830-BL	CFL 2x26W	24	2040	85	3000	0.27
540001296600	LEDceilingLu-E Rd142-24W-840-WH	CFL 2x26W	24	2160	90	4000	0.27
540001296200	LEDceilingLu-E Rd142-24W-840-BL	CFL 2x26W	24	2160	90	4000	0.27

Accessories



542098030700
Junction-Box-WH



5 YEARS WARRANTY



Technical Specifications	
Lifetime (L70)	50,000 h
Lifetime (L80)	30,000 h
On-/Off-cycles	100,000
Dimmability	On-Off
Beam angle	100°
Finishing	White RAL9003 / Black
Colour rendering index (CRI)	≥ 80
Degree of protection (IP)	IP20
Impact strength	IK02
Protection class	II
Risk group (EN 62471)	RG0
With control gear	Yes
Displacement factor (DF)	≥ 0.9

Electrical Supply	
Frequency	50/60 Hz
Nominal voltage	220-240 V AC
DC input voltage	No

Mechanical Properties	
Housing material	Aluminium
Optical material	Polycarbonate

Ambient Conditions	
Operating temperature	-10-+45°C
Application temperature	+25°C
Storage environment	-25-+50°C

Dimensional Drawing (mm)

LEDCeilingLu-E Rd87

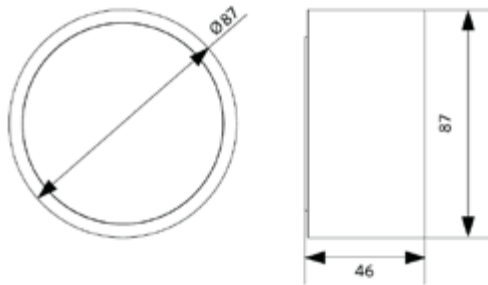

LEDCeilingLu-E Rd112

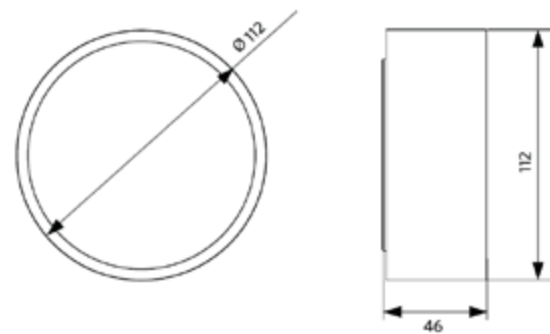

LEDCeilingLu-E Rd142

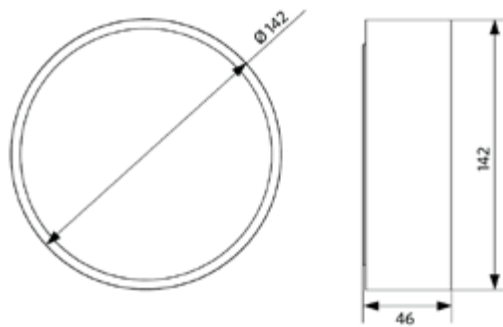



Ceiling Light Apollo



- Professional wall/ceiling luminaire with comfortable diffused light
- Easy installation on wall or ceiling
- Bracket accessory available for easy mounting on existing installations (no new screw holes needed)
- Module Clio inside
- Uniform, diffused light, creating a pleasant atmosphere
- IP44 versions also suitable for bathrooms and comparable spaces
- Energy saving up to 80% in comparison to a traditional light source

Specifications

Item Code	Item Description	Equivalent to (W)	Power (W)	Lumen	Efficacy (lm/W)	CCT (K)	Degree of protection (IP)	Weight (kg/pc)
On-Off								
520020000100	LED HC300 12W 2700K Apollo III	GLS 75W	12	1150	96	2700	IP20	0.43
520020000200	LED HC300 12W 4000K Apollo III	GLS 75W	12	1250	104	4000	IP20	0.43
520021000300	LED HC350 16W 2700K IP44 Apollo III	GLS 100W	16	1450	91	2700	IP44	0.59
520021000400	LED HC350 16W 4000K IP44 Apollo III	GLS 100W	16	1580	99	4000	IP44	0.59
Dimmable (Triac)								
520021000700	LED HC350 22W DIM 2700K IP44 Apollo	GLS 100W	22	1955	89	2700	IP44	0.64
520021000800	LED HC350 22W DIM 4000K IP44 Apollo	GLS 100W	22	2040	93	4000	IP44	0.64

Accessories



140060553
LED Module sensor CT



520098000200
LED Apollo HC300 bracket



520098001800
LED Apollo HC350 bracket

Sensor only for use without dimmer. Sensor range 12m.
HC300 Bracket sold per 2. HC350 Bracket sold per 3.



3 YEARS WARRANTY



Technical Specifications

Lifetime (L70)	30,000 h
Lifetime (L80)	20,000 h
On-/Off-cycles	100,000
Dimmability	On-Off / Triac
Beam angle	120°
Finishing	White RAL9003
Colour rendering index (CRI)	≥ 80
Impact strength	IK03
Protection class	I
Risk group (EN 62471)	RG0
With control gear	Yes

Electrical Supply

Frequency	50/60 Hz
Nominal voltage	220-240 V AC
DC input voltage	No

Mechanical Properties

Housing material	Steel
Optical material	Polycarbonate

Ambient Conditions

Operating temperature	-20~+45°C
Application temperature	+25°C
Storage environment	-25~+50°C

Dimensional Drawing (mm)

LED HC300 12W

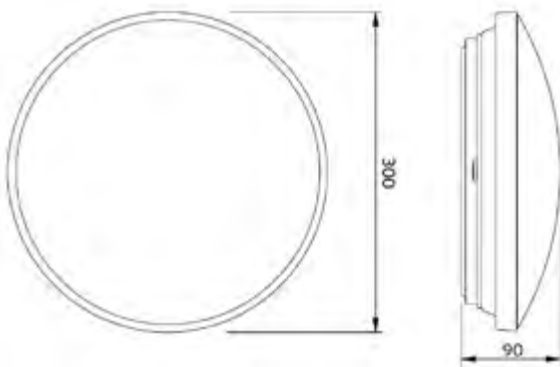

LED HC350 16W
LED HC350 22W

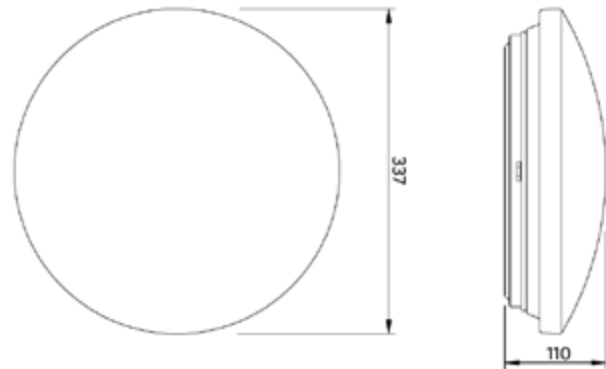

LED Module sensor CT

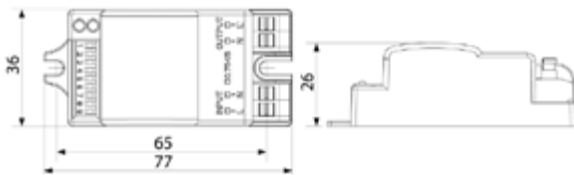

LED Apollo HC300 bracket

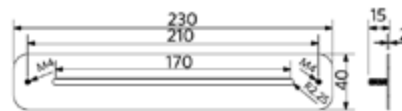

LED Apollo HC350 bracket

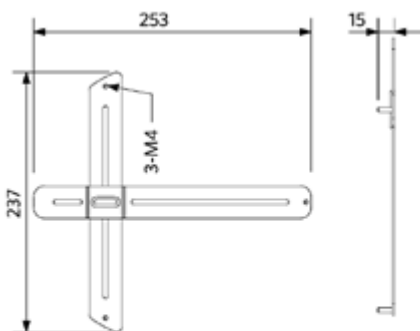



Ceiling Light Apollo Basic

- Cost effective wall/ceiling luminaire with comfortable diffused light
- IP44, suitable for bathrooms and comparable spaces
- Available in 3 lumen packages and 2 colors
- Energy saving up to 80% in comparison to a traditional light source



Specifications

Item Code	Item Description	Equivalent to (W)	Power (W)	Lumen	Efficacy (lm/W)	CCT (K)	Weight (kg/pc)
On-Off							
520028005600	LED HC260 11W 2700K Apollo B	GLS 75W	11	950	86	2700	0.27
520028005700	LED HC260 11W 4000K Apollo B	GLS 75W	11	1050	95	4000	0.27
520021004400	LED HC350 17W 2700K Apollo B	GLS 100W	17	1500	88	2700	0.56
520021004500	LED HC350 17W 4000K Apollo B	GLS 100W	17	1600	94	4000	0.56
520021004600	LED HC350 23W 2700K Apollo B	GLS 100W	23	2100	91	2700	0.56
520021004700	LED HC350 23W 4000K Apollo B	GLS 100W	23	2200	96	4000	0.56

Accessories



140060553
LED Module sensor CT



520098001800
LED Apollo HC350 bracket

Sensor only for 17W and 23W versions. Sensor range 12m.
HC350 Bracket sold per 3.

Technical Specifications		Electrical Supply	
Lifetime (L70)	30,000 h	Frequency	50/60 Hz
Lifetime (L80)	20,000 h	Nominal voltage	220-240 V AC
On-/Off-cycles	100,000	DC input voltage	No
Dimmability	On-Off	Mechanical Properties	
Beam angle	120°	Housing material	Steel
Finishing	White RAL9003	Optical material	Polycarbonate
Colour rendering index (CRI)	≥ 80	Ambient Conditions	
Degree of protection (IP)	IP44	Operating temperature	-20-+45°C
Impact strength	IK03	Application temperature	+25°C
Protection class	II	Storage environment	-25-+50°C
Risk group (EN 62471)	RG0		
With control gear	Yes		



Dimensional Drawing (mm)

LED HC260
11W

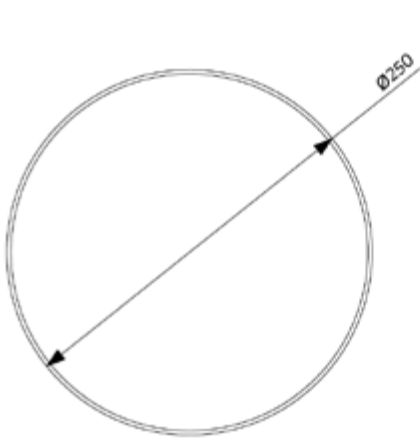

LED Apollo HC350 bracket

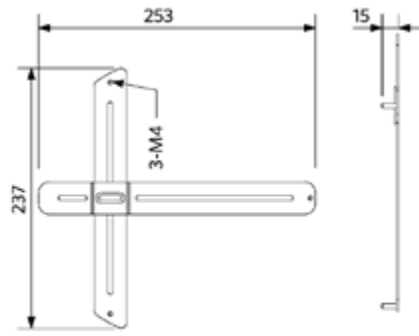

LED HC350
17W & 23W

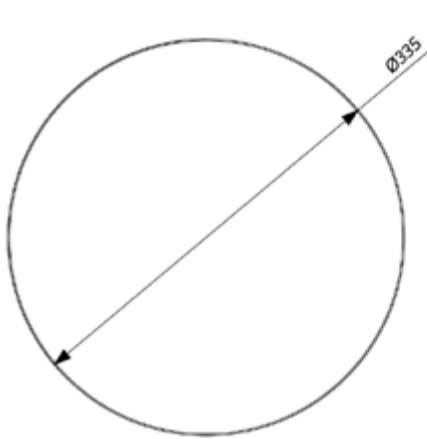

LED Module sensor CT

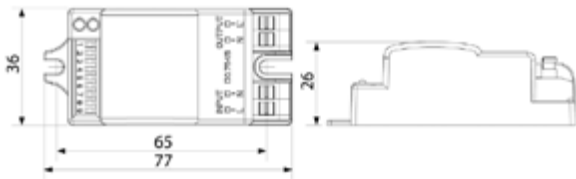



Porchlight EcoMax

- Easy solution for replacing and renovating existing solutions
- IP65 and high IK10 impact resistance for outdoor application
- Master Porchlight with integrated motion and daylight sensor (MD-versions), able to control up to 10 non-MD Porchlight fixtures
- To enhance safety perception, the Porchlight MD is always on at 20% light level at night, with a smooth increase to 100% output when motion is detected
- Detection range, hold time and daylight sensor settings can be easily customized via DIP switch
- Energy saving up to 50% compared to compact fluorescent based fixtures



Specifications

Item Code	Item Description	Equivalent to (W)	Power (W)	Lumen	Efficacy (lm/W)	CCT (K)	With sensor	Weight (kg/pc)
On-Off								
140064477	LEDPorch-E Re120-5W-3000K-WH	TL 8W	5	450	90	3000	No	0.80
140064478	LEDPorch-E Re120-5W-4000K-WH	TL 8W	5	500	100	4000	No	0.80
Motion Detection, Daylight Detection								
140064479	LEDPorch-E Re120-6W-3000K-MD-WH	TL 8W	6	480	80	3000	Yes	0.85
140064480	LEDPorch-E Re120-6W-4000K-MD-WH	TL 8W	6	510	85	4000	Yes	0.85
Emergency version 1 hour, On-Off								
549004004410	LEDPorch-E Re120-5W-3000K-EM1	TL 8W	5	450	90	3000	No	1.03
549004004310	LEDPorch-E Re120-5W-4000K-EM1	TL 8W	5	500	100	4000	No	1.03
Emergency version 1 hour, Motion Detection, Daylight Detection								
549004008310	LEDPorch-E Re120-6W-3000K-MD-EM1	TL 8W	6	480	80	3000	Yes	1.07
549004008210	LEDPorch-E Re120-6W-4000K-MD-EM1	TL 8W	6	510	85	4000	Yes	1.07



5 YEARS WARRANTY



Technical Specifications

Lifetime (L70)	50,000 h
Lifetime (L80)	30,000 h
On-/Off-cycles	100,000
Colour consistency (SDCM)	4
Dimmability	On-Off / Sensor controlled
Sensor type	No / Motion + Daylight detection (MD)
Sensor technology	No / Microwave
Finishing	White
Colour rendering index (CRI)	≥ 80
Degree of protection (IP)	IP65
Impact strength	IK10
Protection class	II
Risk group (EN 62471)	RG0
With control gear	Yes
Glow wire test	650°C
Driver failure rate (at 5,000 hrs)	<0.5 %
Power factor	≥ 0.9

Electrical Supply

Frequency	50/60 Hz
Nominal voltage	220-240 V AC
DC input voltage	See catalogue appendix Connection Specifications

Mechanical Properties

Material housing	Polycarbonate
Optical material	Polycarbonate

Ambient Conditions

Operating temperature	-30-+50°C
Application temperature	+25°C
Storage environment	-30-+60°C

Dimensional Drawing (mm)

LEDPorch-E Re120



Motion sensors - Detection range

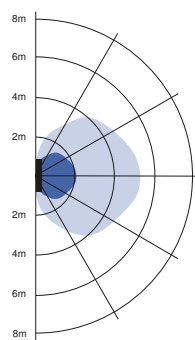

Installation - Wall mounted
Suggested installation height 1-2m

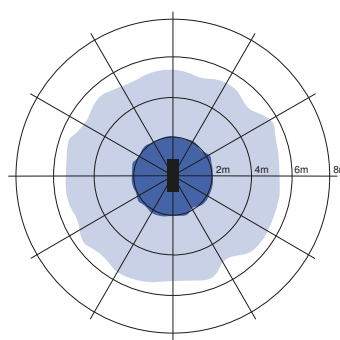

Installation - Ceiling mounted
Suggested installation height 2.5-4m

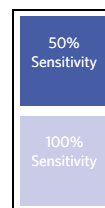



Linear EcoMax

- Easy to install LED linear solution
- Elegant but sturdy design: IP44 and IK06
- Comfortable light due to opal diffuser
- Central or side power connection
- Motion and daylight sensor accessory available
- Perfect 2x18W, 2x36W or 2x58W TL replacement



Specifications

Item Code	Item Description	Equivalent to (W)	Power (W)	Lumen	Efficacy (lm/W)	CCT (K)	Weight (kg/pc)
On-Off							
529001001000	LEDLinear-E CL06-20W-3000-WH	TL 2x18W	20	2100	105	3000	1.47
529001001100	LEDLinear-E CL06-20W-4000-WH	TL 2x18W	20	2300	115	4000	1.47
542005039700	LEDLinear-E CL12-40W-3000-WH	TL 2x36W	40	4320	108	3000	2.78
542005039800	LEDLinear-E CL12-40W-4000-WH	TL 2x36W	40	4720	118	4000	2.78
542005039900	LEDLinear-E CL15-53W-3000-WH	TL 2x58W	53	5930	112	3000	3.46
542005040000	LEDLinear-E CL15-53W-4000-WH	TL 2x58W	53	6360	120	4000	3.46
Emergency version 1 hour, On-Off							
549004010000	LEDLinear-E CL06-20W-3000-WH-EM1	TL 2x18W	20	2100	105	3000	1.77
549004010100	LEDLinear-E CL06-20W-4000-WH-EM1	TL 2x18W	20	2300	115	4000	1.77
549003003800	LEDLinear-E CL12-40W-3000-WH-EM1	TL 2x36W	40	4320	108	3000	3.03
549003003900	LEDLinear-E CL12-40W-4000-WH-EM1	TL 2x36W	40	4720	118	4000	3.03
549003004000	LEDLinear-E CL15-53W-3000-WH-EM1	TL 2x58W	53	5930	112	3000	3.73
549003004100	LEDLinear-E CL15-53W-4000-WH-EM1	TL 2x58W	53	6360	120	4000	3.73
Emergency version 3 hours, On-Off							
549004010200	LEDLinear-E CL06-20W-3000-WH-EM3	TL 2x18W	20	2100	105	3000	1.87
549004010300	LEDLinear-E CL06-20W-4000-WH-EM3	TL 2x18W	20	2300	115	4000	1.87
549003004200	LEDLinear-E CL12-40W-3000-WH-EM3	TL 2x36W	40	4320	108	3000	3.03
549003004300	LEDLinear-E CL12-40W-4000-WH-EM3	TL 2x36W	40	4720	118	4000	3.03
549003004400	LEDLinear-E CL15-53W-3000-WH-EM3	TL 2x58W	53	5930	112	3000	3.73
549003004500	LEDLinear-E CL15-53W-4000-WH-EM3	TL 2x58W	53	6360	120	4000	3.73

Accessories



140060553
LED Module sensor CT



5 YEARS WARRANTY



Technical Specifications	
Lifetime (L70)	70,000 h
Lifetime (L80)	50,000 h
On-/Off-cycles	100,000
Dimmability	On-Off
Beam angle	110°
Finishing	White RAL9003
Colour rendering index (CRI)	≥ 80
Degree of protection (IP)	IP44
Impact strength	IK06
Protection class	I
Risk group (EN 62471)	RG0
With control gear	Yes
Power factor	≥ 0.9

Electrical Supply	
Frequency	50/60 Hz
Nominal voltage	220-240 V AC
DC input voltage	No

Mechanical Properties	
Housing material	Steel
Optical material	PMMA

Ambient Conditions	
Operating temperature	-10-+40°C
Application temperature	+25°C
Storage environment	-25-+50°C

Dimensional Drawing (mm)

LEDLinear-E CL06

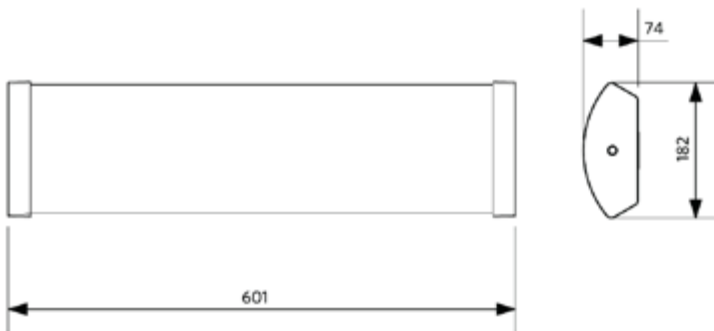

LEDLinear-E CL12

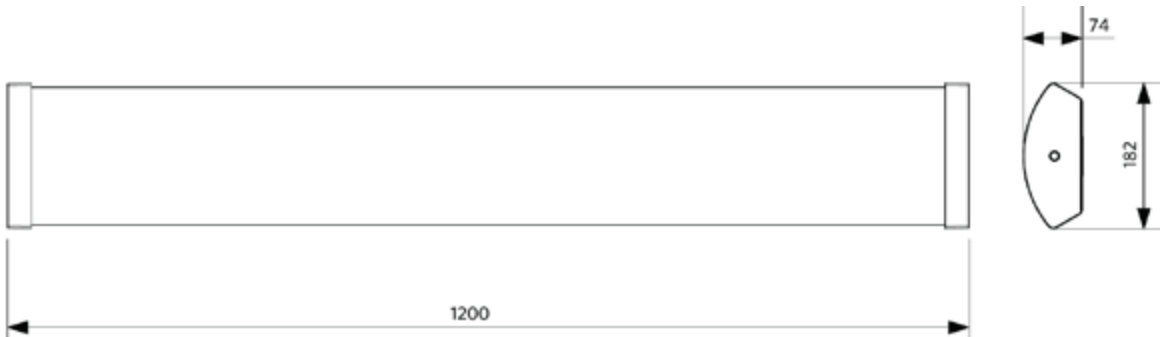

LEDLinear-E CL15

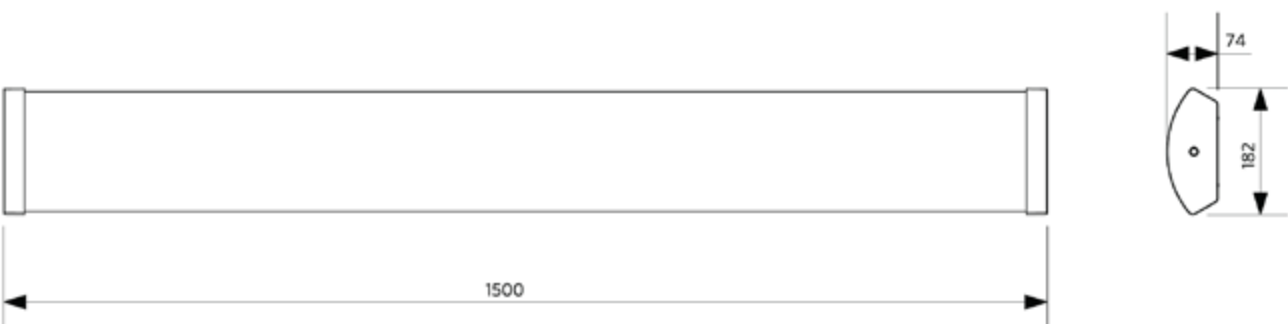



T5 Batten EcoMax

- Linear LED batten
- Uniform, diffused light, creating a pleasant atmosphere
- Trailing edge dimmable
- Up to 50% lower energy consumption
- Battens connect up to 15 meters
- Including power cable, mounting and connection pieces (fixed and flexible)
- With transparent end caps
- Free to position stainless steel mounting clips



Specifications

Item Code	Item Description	Equivalent to (W)	Power (W)	Lumen	Efficacy (lm/W)	CCT (K)	Weight (kg/pc)
On-Off							
140043898	LED E T5 batten 600 9W 3000K CT	TL 1x18W	9	900	100	3000	0.14
140043899	LED E T5 batten 600 9W 4000K CT	TL 1x18W	9	950	106	4000	0.14
140043900	LED E T5 batten 1200 18W 3000K CT	TL 1x36W	18	1850	103	3000	0.26
140043901	LED E T5 batten 1200 18W 4000K CT	TL 1x36W	18	1950	108	4000	0.26
Dimmable (Triac)							
140062784	LED P T5 batten 600 9W DIM 3000K CT	TL 1x18W	9	1100	122	3000	0.29
140062783	LED P T5 batten 600 9W DIM 4000K CT	TL 1x18W	9	1000	111	4000	0.29
140062786	LED P T5 batten 1200 18W DIM 3000K CT	TL 1x36W	18	2300	128	3000	0.41
140062785	LED P T5 batten 1200 18W DIM 4000K CT	TL 1x36W	18	2100	117	4000	0.41

Technical Specifications	
Lifetime (L70)	40,000 h
Lifetime (L80)	30,000 h
On-/Off-cycles	100,000
Dimmability	On-Off / Triac
Beam angle	140
Finishing	White
Colour rendering index (CRI)	≥ 80
Degree of protection (IP)	IP20
Protection class	II
Risk group (EN 62471)	RG0
With control gear	Yes
Power factor	≥ 0.9

Electrical Supply	
Frequency	50/60 Hz
Nominal voltage	220-240 V AC
DC input voltage	No
230V Cable length	1.5 m
230V Connection cable length	0.3 m

Mechanical Properties	
Material housing	Polycarbonate

Ambient Conditions	
Operating temperature	-20-+40°C
Application temperature	+25°C
Storage environment	-25-+50°C



Dimensional Drawing (mm)

LED E T5 batten 600
LED P T5 batten 600

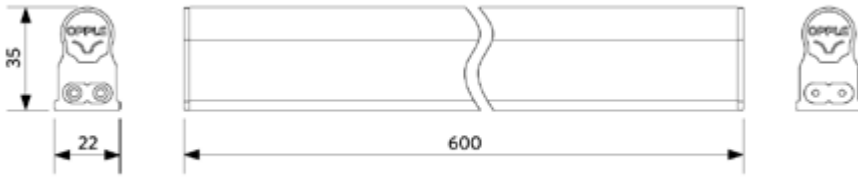

LED E T5 batten 1200
LED P T5 batten 1200

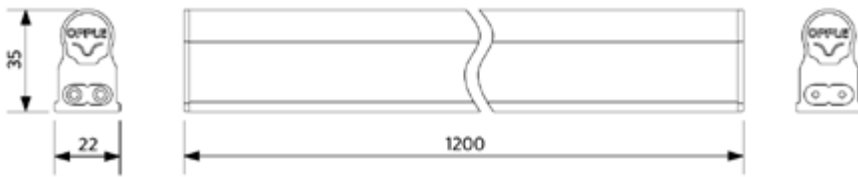

Accessories



Accessories included



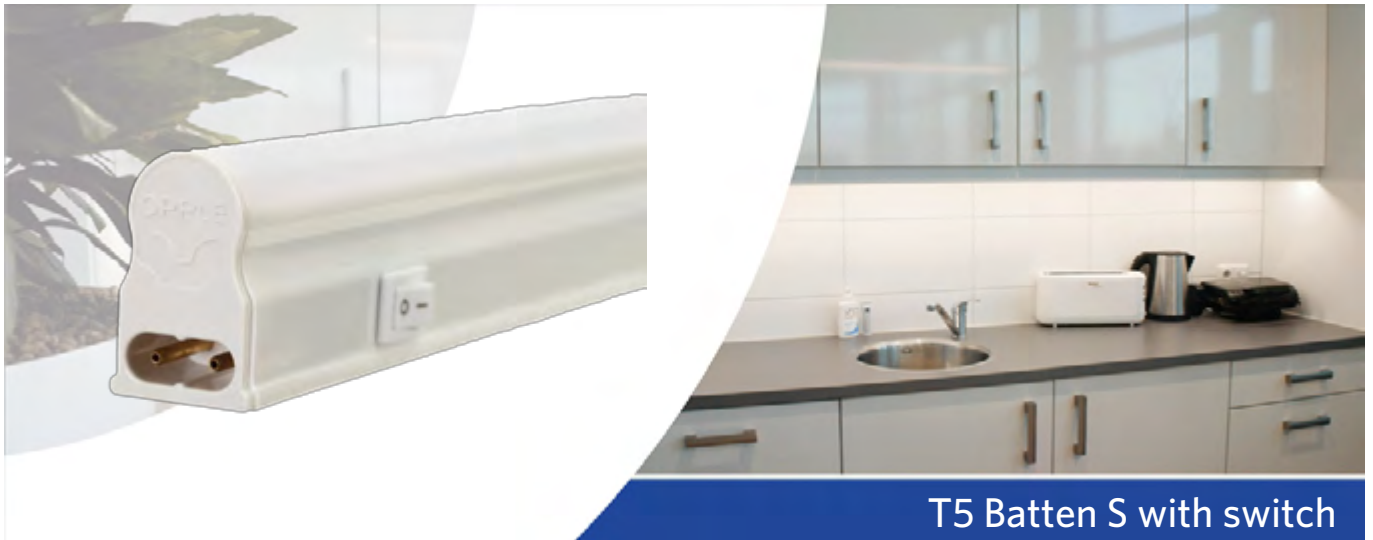

T5 Batten S with switch

- Linear LED batten with power switch
- Uniform, diffused light, creating a pleasant atmosphere
- Available in 300, 600, 900 and 1200 mm
- Battens connect up to 15 meters
- Including power cable, mounting and connection pieces (fixed and flexible)
- Including integrated switch
- Energy saving up to 50%
- Free to position stainless steel mounting clips



Specifications

Item Code	Item Description	Equivalent to (W)	Power (W)	Lumen	Efficacy (lm/W)	CCT (K)	Weight (kg/pc)
On-Off							
140043904	LED E T5 batten 300 4.5W S 3000K BL	TL 1x9W	4.5	450	100	3000	0.08
140044077	LED E T5 batten 300 4.5W S 4000K BL	TL 1x9W	4.5	500	111	4000	0.08
140043903	LED E T5 batten 600 9W S 3000K BL	TL 1x18W	9	900	100	3000	0.15
140044076	LED E T5 batten 600 9W S 4000K BL	TL 1x18W	9	950	106	4000	0.15
140043902	LED E T5 batten 900 11W S 3000K BL	TL 1x18W	11	1100	100	3000	0.20
140044075	LED E T5 batten 900 11W S 4000K BL	TL 1x18W	11	1200	109	4000	0.20
140044293	LED E T5 batten 1200 13W S 3000K BL	TL 1x30W	13	1300	100	3000	0.26
140044292	LED E T5 batten 1200 13W S 4000K BL	TL 1x30W	13	1400	108	4000	0.26

Technical Specifications	
Lifetime (L70)	40,000 h
Lifetime (L80)	30,000 h
On-/Off-cycles	100,000
Dimmability	On-Off
Beam angle	140
Finishing	White
Colour rendering index (CRI)	≥ 80
Degree of protection (IP)	IP20
Protection class	II
Risk group (EN 62471)	RG0
With control gear	Yes
Power factor	≥ 0.9

Electrical Supply	
Frequency	50/60 Hz
Nominal voltage	220-240 V AC
DC input voltage	No
230V Cable length	1.5 m
230V Connection cable length	0.3 m

Mechanical Properties	
Material housing	Polycarbonate

Ambient Conditions	
Operating temperature	-20-+40°C
Application temperature	+25°C
Storage environment	-25-+50°C



Dimensional Drawing (mm)

LED E T5 batten 300

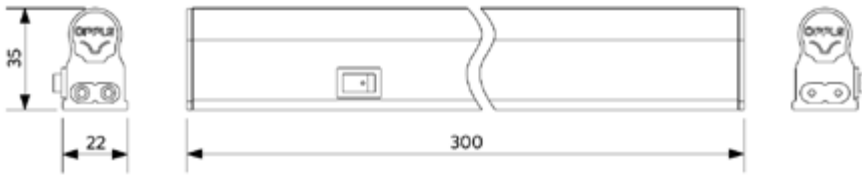

LED E T5 batten 600

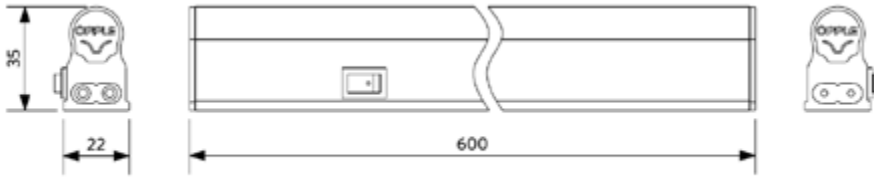

LED E T5 batten 900

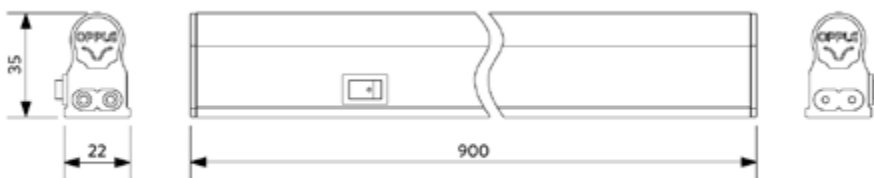

LED E T5 batten 1200

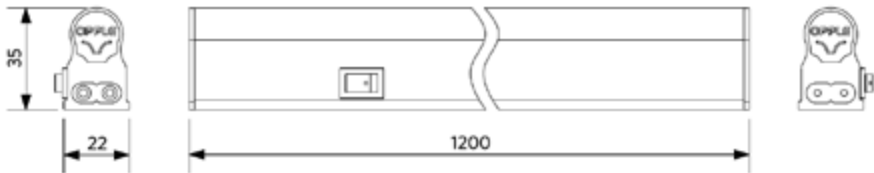

Accessories



Accessories included





Highbay Performer G4

- High quality LED Highbay solution with advanced ultra slim design
- Very high efficacy of 145 lm/W
- Available as Smart Lighting solution (BLE), DALI2 or motion sensor (MD)
- Three different beam angles: wide, medium and asymmetric
- Four lumen packages, up to 32,000 lm
- Equipped with IP68 connector



Specifications

Item Code	Item Description	Equivalent to (W)	Power (W)	Lumen	Efficacy (lm/W)	CCT (K)	Beam angle	Weight (kg/pc)
On-Off								
545001002600	LEDHighbay-P4 80W-4000-95D	HID 250W	80	11600	145	4000	95°	2.68
545001002500	LEDHighbay-P4 80W-4000-50D	HID 250W	80	11600	145	4000	50°	2.68
545001002700	LEDHighbay-P4 80W-4000-50x95D	HID 250W	80	11600	145	4000	50° x 95°	2.68
545001014700	LEDHighbay-P4 80W-5700-95D	HID 250W	80	11600	145	5700	95°	2.68
545001014600	LEDHighbay-P4 80W-5700-50D	HID 250W	80	11600	145	5700	50°	2.68
545001014800	LEDHighbay-P4 80W-5700-50x95D	HID 250W	80	11600	145	5700	50° x 95°	2.68
545001003200	LEDHighbay-P4 110W-4000-95D	HID 400W	110	16000	145	4000	95°	2.68
545001003100	LEDHighbay-P4 110W-4000-50D	HID 400W	110	16000	145	4000	50°	2.68
545001003300	LEDHighbay-P4 110W-4000-50x95D	HID 400W	110	16000	145	4000	50° x 95°	2.68
545001015000	LEDHighbay-P4 110W-5700-95D	HID 400W	110	16000	145	5700	95°	2.68
545001014900	LEDHighbay-P4 110W-5700-50D	HID 400W	110	16000	145	5700	50°	2.68
545001015100	LEDHighbay-P4 110W-5700-50x95D	HID 400W	110	16000	145	5700	50° x 95°	2.68
545001001200	LEDHighbay-P4 155W-4000-100D	HID 400W	155	22000	145	4000	100°	3.56
545001001100	LEDHighbay-P4 155W-4000-60D	HID 400W	155	22000	145	4000	60°	3.56
545001003700	LEDHighbay-P4 155W-4000-60x100D	HID 400W	155	22000	145	4000	60° x 100°	3.56
545001012400	LEDHighbay-P4 155W-5700-100D	HID 400W	155	22000	145	5700	100°	3.56
545001015200	LEDHighbay-P4 155W-5700-60D	HID 400W	155	22000	145	5700	60°	3.56
545001015300	LEDHighbay-P4 155W-5700-60x100D	HID 400W	155	22000	145	5700	60° x 100°	3.56
545001000900	LEDHighbay-P4 220W-4000-100D	HID 600W	220	32000	145	4000	100°	3.56
545001001000	LEDHighbay-P4 220W-4000-60D	HID 600W	220	32000	145	4000	60°	3.56
545001003900	LEDHighbay-P4 220W-4000-60x100D	HID 600W	220	32000	145	4000	60° x 100°	3.56
545001012300	LEDHighbay-P4 220W-5700-100D	HID 600W	220	32000	145	5700	100°	3.56
545001015400	LEDHighbay-P4 220W-5700-60D	HID 600W	220	32000	145	5700	60°	3.56
545001015500	LEDHighbay-P4 220W-5700-60x100D	HID 600W	220	32000	145	5700	60° x 100°	3.56
DALI2								
545001002900	LEDHighbay-P4 80W-DALI-4000-95D	HID 250W	80	11600	145	4000	95°	2.68
545001002800	LEDHighbay-P4 80W-DALI-4000-50D	HID 250W	80	11600	145	4000	50°	2.68
545001003000	LEDHighbay-P4 80W-DALI-4000-50x95D	HID 250W	80	11600	145	4000	50° x 95°	2.68
545001015700	LEDHighbay-P4 80W-DALI-5700-95D	HID 250W	80	11600	145	5700	95°	2.68
545001015600	LEDHighbay-P4 80W-DALI-5700-50D	HID 250W	80	11600	145	5700	50°	2.68
545001015800	LEDHighbay-P4 80W-DALI-5700-50x95D	HID 250W	80	11600	145	5700	50° x 95°	2.68



Item Code	Item Description	Equivalent to (W)	Power (W)	Lumen	Efficacy (lm/W)	CCT (K)	Beam angle	Weight (kg/pc)
DALI2								
545001003500	LEDHighbay-P4 110W-DALI-4000-95D	HID 400W	110	16000	145	4000	95°	2.68
545001003400	LEDHighbay-P4 110W-DALI-4000-50D	HID 400W	110	16000	145	4000	50°	2.68
545001003600	LEDHighbay-P4 110W-DALI-4000-50x95D	HID 400W	110	16000	145	4000	50° x 95°	2.68
545001016000	LEDHighbay-P4 110W-DALI-5700-95D	HID 400W	110	16000	145	5700	95°	2.68
545001015900	LEDHighbay-P4 110W-DALI-5700-50D	HID 400W	110	16000	145	5700	50°	2.68
545001016100	LEDHighbay-P4 110W-DALI-5700-50x95D	HID 400W	110	16000	145	5700	50° x 95°	2.68
545001001400	LEDHighbay-P4 155W-DALI-4000-100D	HID 400W	155	22000	145	4000	100°	3.56
545001001300	LEDHighbay-P4 155W-DALI-4000-60D	HID 400W	155	22000	145	4000	60°	3.56
545001003800	LEDHighbay-P4 155W-DALI-4000-60x100D	HID 400W	155	22000	145	4000	60° x 100°	3.56
545001016300	LEDHighbay-P4 155W-DALI-5700-100D	HID 400W	155	22000	145	5700	100°	3.56
545001016200	LEDHighbay-P4 155W-DALI-5700-60D	HID 400W	155	22000	145	5700	60°	3.56
545001016400	LEDHighbay-P4 155W-DALI-5700-60x100D	HID 400W	155	22000	145	5700	60° x 100°	3.56
545001001600	LEDHighbay-P4 220W-DALI-4000-100D	HID 600W	220	32000	145	4000	100°	3.56
545001001500	LEDHighbay-P4 220W-DALI-4000-60D	HID 600W	220	32000	145	4000	60°	3.56
545001004000	LEDHighbay-P4 220W-DALI-4000-60x100D	HID 600W	220	32000	145	4000	60° x 100°	3.56
545001016600	LEDHighbay-P4 220W-DALI-5700-100D	HID 600W	220	32000	145	5700	100°	3.56
545001016500	LEDHighbay-P4 220W-DALI-5700-60D	HID 600W	220	32000	145	5700	60°	3.56
545001016700	LEDHighbay-P4 220W-DALI-5700-60x100D	HID 600W	220	32000	145	5700	60° x 100°	3.56
Smart								
545001009800	LEDHighbay-P4 80W-4000-W-BLE	HID 250W	80	11600	145	4000	95°	2.68
545001009700	LEDHighbay-P4 80W-4000-N-BLE	HID 250W	80	11600	145	4000	50°	2.68
545001009600	LEDHighbay-P4 80W-4000-AS-BLE	HID 250W	80	11600	145	4000	50° x 95°	2.68
545001024400	LEDHighbay-P4 80W-5700-W-BLE	HID 250W	80	11600	145	5700	95°	2.68
545001024300	LEDHighbay-P4 80W-5700-N-BLE	HID 250W	80	11600	145	5700	50°	2.68
545001024500	LEDHighbay-P4 80W-5700-AS-BLE	HID 250W	80	11600	145	5700	50° x 95°	2.68
545001009400	LEDHighbay-P4 110W-4000-W-BLE	HID 400W	110	16000	145	4000	95°	2.68
545001009500	LEDHighbay-P4 110W-4000-N-BLE	HID 400W	110	16000	145	4000	50°	2.68
545001009300	LEDHighbay-P4 110W-4000-AS-BLE	HID 400W	110	16000	145	4000	50° x 95°	2.68
545001024700	LEDHighbay-P4 110W-5700-W-BLE	HID 400W	110	16000	145	5700	95°	2.68
545001024600	LEDHighbay-P4 110W-5700-N-BLE	HID 400W	110	16000	145	5700	50°	2.68
545001024800	LEDHighbay-P4 110W-5700-AS-BLE	HID 400W	110	16000	145	5700	50° x 95°	2.68
545001009100	LEDHighbay-P4 155W-4000-W-BLE	HID 400W	155	22000	145	4000	100°	3.56
545001009200	LEDHighbay-P4 155W-4000-N-BLE	HID 400W	155	22000	145	4000	60°	3.56
545001009000	LEDHighbay-P4 155W-4000-AS-BLE	HID 400W	155	22000	145	4000	60° x 100°	3.56
545001025000	LEDHighbay-P4 155W-5700-W-BLE	HID 400W	155	22000	145	5700	100°	3.56
545001024900	LEDHighbay-P4 155W-5700-N-BLE	HID 400W	155	22000	145	5700	60°	3.56
545001025100	LEDHighbay-P4 155W-5700-AS-BLE	HID 400W	155	22000	145	5700	60° x 100°	3.56
545001008800	LEDHighbay-P4 220W-4000-W-BLE	HID 600W	220	32000	145	4000	100°	3.56
545001008900	LEDHighbay-P4 220W-4000-N-BLE	HID 600W	220	32000	145	4000	60°	3.56
545001008700	LEDHighbay-P4 220W-4000-AS-BLE	HID 600W	220	32000	145	4000	60° x 100°	3.56
545001025300	LEDHighbay-P4 220W-5700-W-BLE	HID 600W	220	32000	145	5700	100°	3.56
545001025200	LEDHighbay-P4 220W-5700-N-BLE	HID 600W	220	32000	145	5700	60°	3.56
545001025400	LEDHighbay-P4 220W-5700-AS-BLE	HID 600W	220	32000	145	5700	60° x 100°	3.56
Motion Detection, Daylight Detection								
545001010300	LEDHighbay-P4 80W-4000-W-MD	HID 250W	80	11600	145	4000	95°	2.51
545001010100	LEDHighbay-P4 80W-4000-N-MD	HID 250W	80	11600	145	4000	50°	2.51
545001010400	LEDHighbay-P4 80W-4000-AS-MD	HID 250W	80	11600	145	4000	50° x 95°	2.51
545001010200	LEDHighbay-P4 110W-4000-W-MD	HID 400W	110	16000	145	4000	95°	2.51
545001010500	LEDHighbay-P4 110W-4000-N-MD	HID 400W	110	16000	145	4000	50°	2.51
545001010600	LEDHighbay-P4 110W-4000-AS-MD	HID 400W	110	16000	145	4000	50° x 95°	2.51
545001011500	LEDHighbay-P4 155W-4000-W-MD	HID 400W	155	22000	145	4000	100°	3.54
545001010700	LEDHighbay-P4 155W-4000-N-MD	HID 400W	155	22000	145	4000	60°	3.54
545001010800	LEDHighbay-P4 155W-4000-AS-MD	HID 400W	155	22000	145	4000	60° x 100°	3.54

DALI2 versions are compatible with central emergency lighting according to EN 50172. For more technical information, please go to the appendix.



Accessories



545098000500
LEDHighbay-P4 Bracket-D330



545098003500
LEDHighbay-P4 Reflector-D330



543098021900
LEDFixture-IP68-Connector-Kit-3



543098022000
LEDFixture-IP68-Connector-Kit-5



543098024500
LEDHighbay-P4-Remote Controller



545098003200
LEDHighbay-Pole and Adapter

545098000600
LEDHighbay-P4 Bracket-D420

545098003600
LEDHighbay-P4 Reflector-D420

545098003900
LEDHighbay-Pole

Highbay Pole and Adapter (545098003200) is only compatible with 80W and 110W versions. Highbay Pole (545098003900) is only compatible with 155W and 220W versions.

Remote Controller can only be used in combination with Motion Detection (MD) versions. Remote Controller sold excluding 2x AAA batteries. For more technical information (Remote Controller), please go to the appendix.

Technical Specifications		Electrical Supply	
Lifetime (L70)	70,000 h	Frequency	50/60 Hz
Lifetime (L80)	50,000 h	Nominal voltage	220-240 V AC
On-/Off-cycles	100,000	DC input voltage	See catalogue appendix
Colour consistency (SDCM)	4	Connection	Specifications
Dimmability	On-Off / DALI / BLE / Sensor controlled	230V Cable length	1 m
Sensor type	No / Motion + Daylight detection (MD)	Mechanical Properties	
Sensor technology	No / Microwave	Housing material	Aluminium
Finishing	Grey Pantone 417U	UV resistant	Yes
Colour rendering index (CRI)	≥ 80	Optical material	Polycarbonate
Degree of protection (IP)	IP66	Cover material	Polycarbonate
Impact strength	IK08	Ambient Conditions	
Protection class	I	Operating temperature	-30-+50°C
Risk group (EN 62471)	RG1	Application temperature	+25°C
With control gear	Yes	Storage environment	-30-+60°C
Glow wire test	850°C		
Driver failure rate (at 5,000 hrs)	<0.5 %		
Power factor	≥ 0.9		
Surge protection	4 kV		



Dimensional Drawing (mm)

LEDHighbay-P4
80W & 110W

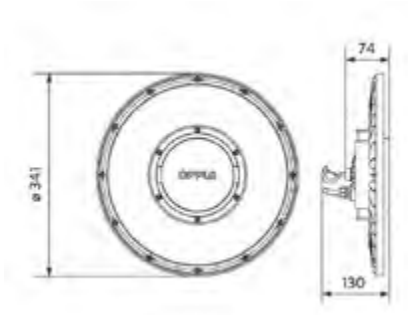

LEDHighbay-P4
80W & 110W Motion Detection

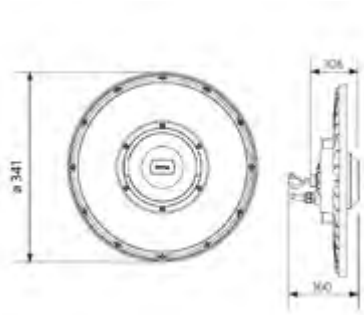

LEDHighbay-P4 Reflector-D330

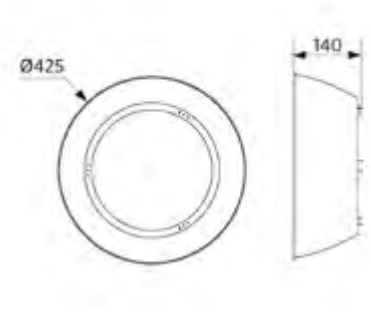

LEDHighbay-P4
155W & 220W

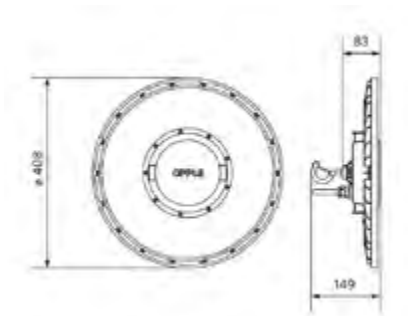

LEDHighbay-P4
155W & 220W Motion Detection

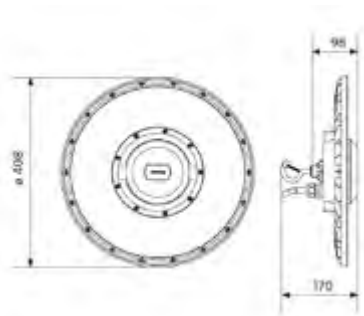

LEDHighbay-P4 Reflector-D420

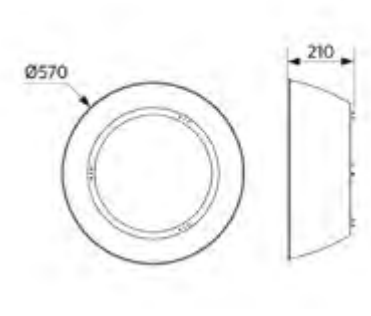

LEDHighbay-P4 Bracket-D330

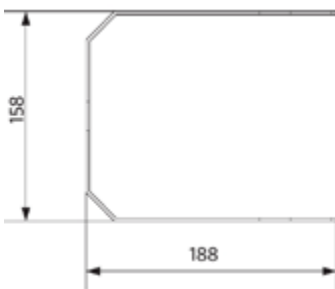

LEDHighbay-P4 Bracket-D420

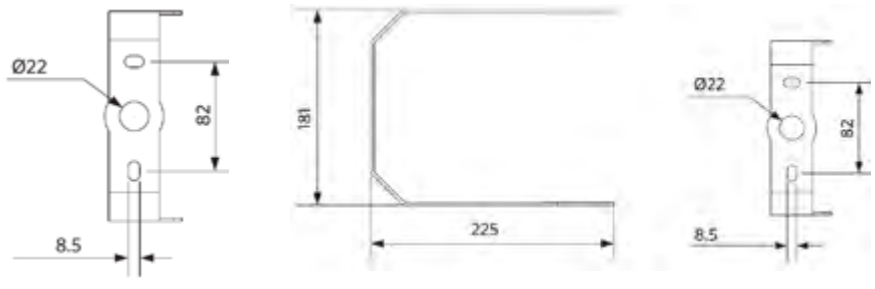

Motion sensors - Detection range

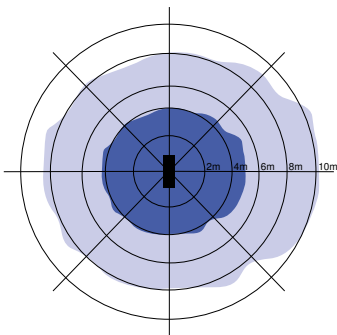

Installation - Low ceiling
Suggested installation height 9m

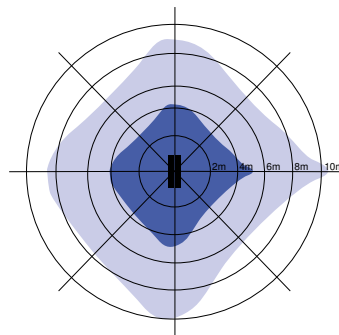

Installation - Medium ceiling
Suggested installation height 12m

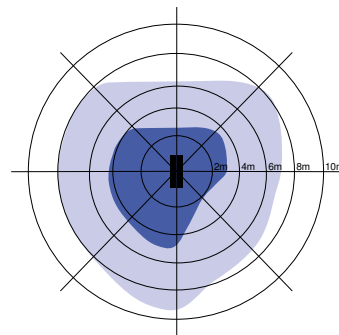

Installation - High ceiling
Suggested installation height 15m

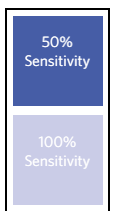



Highbay EcoMax G2

- Cost effective highbay solution
- Elegant slim design
- Improved efficacy up to 130 lm/W
- Five lumen packages, up to 31,200 lm
- Narrow beam versions available (200+240W)
- Up to 60% energy saving compared to HID solutions
- Reflectors, bracket and IP68 connector available as accessory



Specifications

Item Code	Item Description	Equivalent to (W)	Power (W)	Lumen	Efficacy (lm/W)	CCT (K)	Beam angle	Weight (kg/pc)
On-Off								
545001047200	LEDHighbay-E2 80W-840-W	HID 250W	80	10400	130	4000	90°	1.74
545001047400	LEDHighbay-E2 80W-857-W	HID 250W	80	10400	130	5700	90°	1.74
545001047600	LEDHighbay-E2 120W-840-W	HID 400W	120	15600	130	4000	90°	2.41
545001047800	LEDHighbay-E2 120W-857-W	HID 400W	120	15600	130	5700	90°	2.41
545001048000	LEDHighbay-E2 150W-840-W	HID 400W	150	19500	130	4000	90°	2.41
545001048200	LEDHighbay-E2 150W-857-W	HID 400W	150	19500	130	5700	90°	2.41
545001048300	LEDHighbay-E2 200W-840-N	HID 400W HO	200	26000	130	4000	65°	3.34
545001048400	LEDHighbay-E2 200W-840-W	HID 400W HO	200	26000	130	4000	90°	3.34
545001048600	LEDHighbay-E2 200W-857-W	HID 400W HO	200	26000	130	5700	90°	3.34
545001048700	LEDHighbay-E2 240W-840-N	HID 600W	240	31200	130	4000	65°	3.34
545001048800	LEDHighbay-E2 240W-840-W	HID 600W	240	31200	130	4000	90°	3.34
545001049000	LEDHighbay-E2 240W-857-W	HID 600W	240	31200	130	5700	90°	3.34

Accessories



545098006100
LEDHighbay-E2 Reflector-
Rd407



545098006200
LEDHighbay-E2 Reflector-
Rd507



545098006300
LEDHighbay-E2 Reflector-
Rd602



545098006000
LEDHighbay-E2 Bracket-L249



543098021900
LEDFixture-IP68-Connector-
Kit-3

Reflector Rd407 (545098006100) fits 80W versions, Reflector Rd507 (545098006200) fits 120W and 150W versions and Reflector Rd602 (545098006300) fits 200W and 240W versions.



5 YEARS WARRANTY



Technical Specifications	
Lifetime (L70)	50,000 h
Lifetime (L80)	30,000 h
On-/Off-cycles	100,000
Colour consistency (SDCM)	4
Dimmability	On-Off
Finishing	Grey Pantone 417U
Colour rendering index (CRI)	≥ 80
Degree of protection (IP)	IP65
Impact strength	IK08
Protection class	I
Risk group (EN 62471)	RG1
With control gear	Yes
Glow wire test	850°C
Driver failure rate (at 5,000 hrs)	<1 %
Power factor	≥ 0.9
Surge protection	4 kV

Electrical Supply	
Frequency	50/60 Hz
Nominal voltage	220-240 V AC
DC input voltage	No
230V Cable length	1 m

Mechanical Properties	
Housing material	Aluminium
Optical material	Polycarbonate
Cover material	Polycarbonate

Ambient Conditions	
Operating temperature	-30-+50°C
Application temperature	+25°C
Storage environment	-30-+50°C

Dimensional Drawing (mm)

LEDHighbay-E2 80W

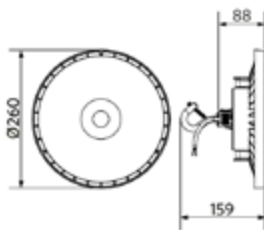

LEDHighbay-E2
120W & 150W

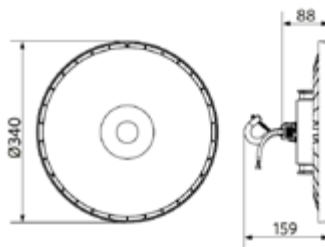

LEDHighbay-E2
200W & 240W

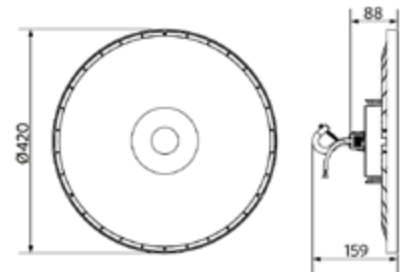

LEDHighbay-E2 Reflector-Rd407

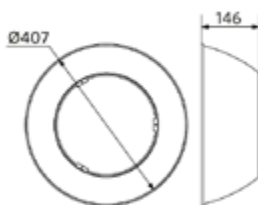

LEDHighbay-E2 Reflector-Rd507

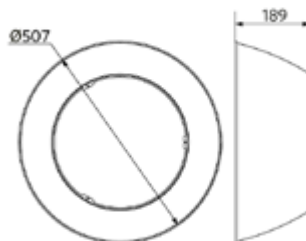

LEDHighbay-E2 Reflector-Rd602

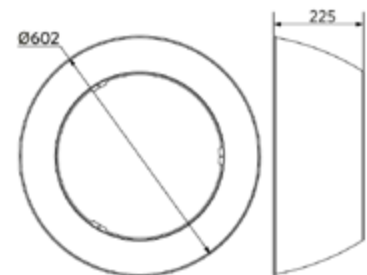

LEDHighbay-E2 Bracket-L249

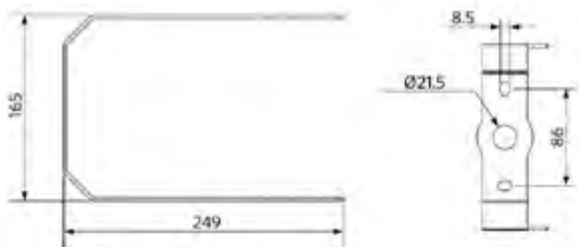



Waterproof Special

- Tubular waterproof luminaire with extra high IP rating
- Suitable for outdoor application thanks to IP67/IP69K rating
- Ammonium-resistant, suitable for livestock applications
- Comfortable homogeneous light distribution
- Easy installation due to free to position stainless steel mounting brackets
- High efficacy of up to 135 lm/W
- Equipped with 3x2.5mm² throughwiring



Specifications

Item Code	Item Description	Equivalent to (W)	Power (W)	Lumen	Efficacy (lm/W)	CCT (K)	Internal wiring (mm ²)	Weight (kg/pc)
On-Off								
543022021100	LEDWaterproof SE-P L1250-24W-840-IP69K	TL 1x36W	24	3240	135	4000	3x2.5	1.71
543022021200	LEDWaterproof SE-P L1250-45W-840-IP69K	TL 2x36W	45	6075	135	4000	3x2.5	1.71
543022021300	LEDWaterproof SE-P L1550-34W-840-IP69K	TL 1x58W	34	4590	135	4000	3x2.5	1.98
543022021400	LEDWaterproof SE-P L1550-54W-840-IP69K	TL 2x58W	54	7290	135	4000	3x2.5	1.98

Technical Specifications	
Lifetime (L70)	70,000 h
Lifetime (L80)	50,000 h
On-/Off-cycles	100,000
Colour consistency (SDCM)	4
Dimmability	On-Off
Beam angle	120°
Finishing	Grey RAL 7035
Colour rendering index (CRI)	≥ 80
Degree of protection (IP)	IP67/IP69K
Impact strength	IK06
Protection class	I
Risk group (EN 62471)	RG0
With control gear	Yes
Glow wire test	650°C
Driver failure rate (at 5,000 hrs)	<0.5 %
Power factor	≥ 0.9
Input wire diameter	1mm ² - 2.5mm ²
Max. input cable diameter (mm)	4-11 mm

Electrical Supply	
Frequency	50/60 Hz
Nominal voltage	220-240 V AC
DC input voltage	See catalogue appendix Connection Specifications

Mechanical Properties	
Material housing	PMMA
UV resistant	Yes
Optical material	PMMA
Mounting clips	Stainless steel (316)

Ambient Conditions	
Operating temperature	-25-+45°C
Application temperature	+25°C
Storage environment	-30-+60°C

5 YEARS WARRANTY



Dimensional Drawing (mm)

LEDWaterproof SE-P L1250

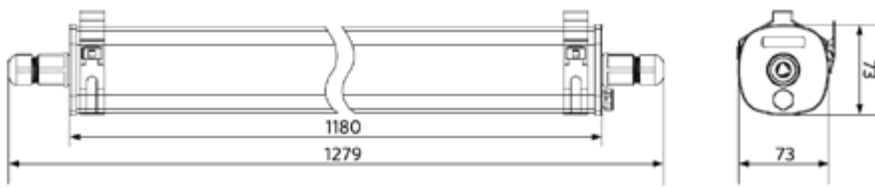

LEDWaterproof SE-P L1550

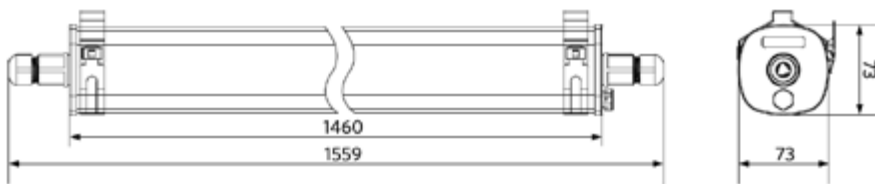

Installation Possibilities

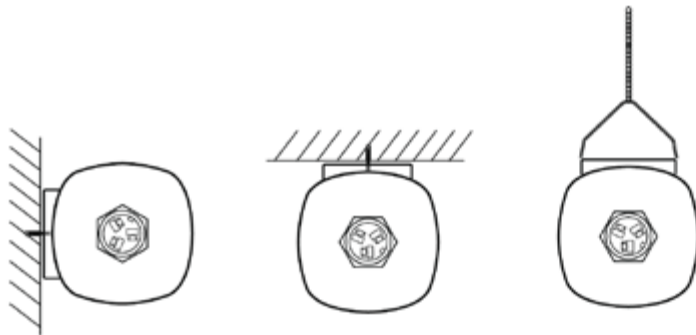



Waterproof Performer G3

- Powerful range of waterproof luminaires in specific "sealed for life" design
- High efficacy up to 140 lm/W
- Available as Smart Lighting solution (BLE) and DALI2
- Quick installation thanks to its screwless endcap
- Supplied with vandal-proof stainless steel ceiling and suspension clips
- Equipped with throughwiring, special PLUS version with 2 additional internal wires
- DALI2 driver compatible with 230V push dimming



Specifications

Item Code	Item Description	Equivalent to (W)	Power (W)	Lumen	Efficacy (lm/W)	CCT (K)	Internal wiring (mm ²)	Max. input cable diameter (mm)	Weight (kg/pc)
On-Off									
543022015500	LEDWaterproof-P3 L710-12.5W-4000	TL 1x18W	12.5	1700	135	4000	3x2.5	7-11	0.89
543022015600	LEDWaterproof-P3 L710-24W-4000	TL 2x18W	24	3240	135	4000	3x2.5	7-11	0.89
543022015800	LEDWaterproof-P3 L1310-24W-4000	TL 1x36W	24	3360	140	4000	3x2.5	7-11	1.55
543022015700	LEDWaterproof-P3 L1310-38W-4000	TL 2x36W	38	5320	140	4000	3x2.5	7-11	1.55
543022016300	LEDWaterproof-P3 L1310-38W-4000-PLUS	TL 2x36W	38	5320	140	4000	5x2.5	8-14	1.60
543022015900	LEDWaterproof-P3 L1310-38W-6500	TL 2x36W	38	5320	140	6500	3x2.5	7-11	1.55
543022016000	LEDWaterproof-P3 L1610-31W-4000	TL 1x58W	31	4340	140	4000	3x2.5	7-11	1.71
543022016400	LEDWaterproof-P3 L1610-31W-4000-PLUS	TL 1x58W	31	4340	140	4000	5x2.5	8-14	1.77
543022016100	LEDWaterproof-P3 L1610-47W-4000	TL 2x58W	47	6580	140	4000	3x2.5	7-11	1.71
543022016200	LEDWaterproof-P3 L1610-54W-4000	TL 2x58W	54	7560	140	4000	3x2.5	7-11	1.71
543022016500	LEDWaterproof-P3 L1610-54W-4000-PLUS	TL 2x58W	54	7560	140	4000	5x2.5	8-14	1.77
543022016600	LEDWaterproof-P3 L1610-54W-6500	TL 2x58W	54	7560	140	6500	3x2.5	7-11	1.71
543022024100	LEDWaterproof-P3 L1610-75W-4000	TL 2x80W	75	9750	130	4000	3x2.5	7-11	2.44
543022024200	LEDWaterproof-P3 L1610-90W-4000	2x TLM 140W RS	90	12150	135	4000	3x2.5	7-11	2.44
DALI2									
543022018200	LEDWaterproof-P3 L710-22W-4000-DALI	TL 2x18W	22	3000	135	4000	5x2.5	8-14	0.89
543022018500	LEDWaterproof-P3 L1310-36W-4000-DALI	TL 2x36W	36	5040	140	4000	5x2.5	8-14	1.55
543022018600	LEDWaterproof-P3 L1610-31W-4000-DALI	TL 1x58W	31	4340	140	4000	5x2.5	8-14	1.71
543022018800	LEDWaterproof-P3 L1610-51W-4000-DALI	TL 2x58W	51	7140	140	4000	5x2.5	8-14	1.71
Smart									
543022019300	LEDWaterproof-P3 L1310-36W-4000-BLE	TL 2x36W	36	5040	140	4000	3x2.5	7-11	1.55
543022019600	LEDWaterproof-P3 L1610-51W-4000-BLE	TL 2x58W	51	7140	140	4000	3x2.5	7-11	1.71



Dimensional Drawing (mm)

LEDWaterproof-P3 L710

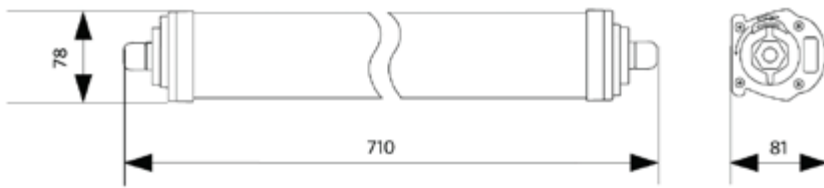

LEDWaterproof-P3 L1310

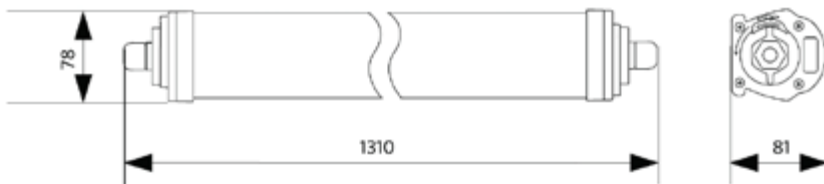

LEDWaterproof-P3 L1610

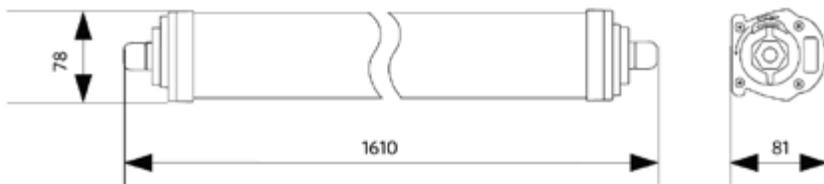

Installation Possibilities

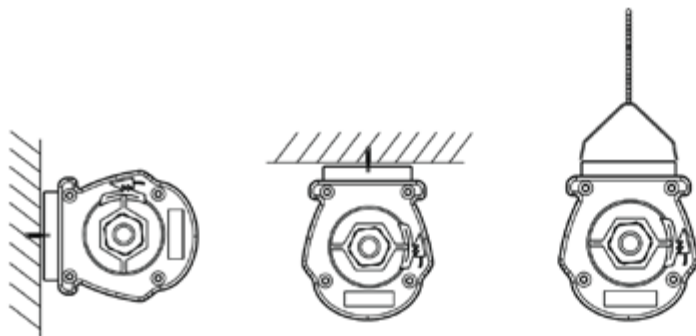





Waterproof Classic

- Compact retrofit waterproof luminaire, with removable cover
- Available in 3 lengths and 4 lumen packages, with efficacy of 125 lm/W
- Flexible installation: possible to wire from the back and sides
- Available with integrated motion sensor (MD), for automatic on/off switching
- Compatible with 2.5mm² wires, 5-wire through wiring possible
- Easy, vandalism-proof mounting clips



Specifications

Item Code	Item Description	Equivalent to (W)	Power (W)	Lumen	Efficacy (lm/W)	CCT (K)	Weight (kg/pc)
On-Off							
531000003000	LEDWaterproof-CLA-E L650-20W-4000	TL 2x18W	20	2500	125	4000	0.81
531000004100	LEDWaterproof-CLA-E L1250-20W-4000	TL 1x36W	20	2500	125	4000	1.49
531000004200	LEDWaterproof-CLA-E L1250-43W-4000	TL 2x36W	43	5375	125	4000	1.49
531000004300	LEDWaterproof-CLA-E L1550-29W-4000	TL 1x58W	29	3625	125	4000	1.87
531000004400	LEDWaterproof-CLA-E L1550-53W-4000	TL 2x58W	53	6625	125	4000	1.87
Motion Detection, Daylight Detection							
531000003900	LEDWaterproof-CLA-E L1250-20W-4000-MD	TL 1x36W	20	2500	125	4000	1.49
531000003800	LEDWaterproof-CLA-E L1250-43W-4000-MD	TL 2x36W	43	5375	125	4000	1.49
531000003700	LEDWaterproof-CLA-E L1550-29W-4000-MD	TL 1x58W	29	3625	125	4000	1.87
531000003600	LEDWaterproof-CLA-E L1550-53W-4000-MD	TL 2x58W	53	6625	125	4000	1.87
Emergency version 1 hour, On-Off							
549013000900	LEDWaterproof-CLA-E L650-20W-4000-EM1	TL 2x18W	20	2500	125	4000	0.99
549013001000	LEDWaterproof-CLA-E L1250-20W-4000-EM1	TL 1x36W	20	2500	125	4000	1.67
549013001100	LEDWaterproof-CLA-E L1250-43W-4000-EM1	TL 2x36W	43	5375	125	4000	1.67
549013001200	LEDWaterproof-CLA-E L1550-29W-4000-EM1	TL 1x58W	29	3625	125	4000	2.05
549013001300	LEDWaterproof-CLA-E L1550-53W-4000-EM1	TL 2x58W	53	6625	125	4000	2.05
Emergency version 3 hours, On-Off							
549013001400	LEDWaterproof-CLA-E L650-20W-4000-EM3	TL 2x18W	20	2500	125	4000	1.29
549013001500	LEDWaterproof-CLA-E L1250-20W-4000-EM3	TL 1x36W	20	2500	125	4000	1.97
549013001600	LEDWaterproof-CLA-E L1250-43W-4000-EM3	TL 2x36W	43	5375	125	4000	1.97
549013001700	LEDWaterproof-CLA-E L1550-29W-4000-EM3	TL 1x58W	29	3625	125	4000	2.35
549013001800	LEDWaterproof-CLA-E L1550-53W-4000-EM3	TL 2x58W	53	6625	125	4000	2.35



Accessories



531098000100
LEDWaterproof-CLA-Sensor

Technical Specifications

Lifetime (L70)	50,000 h
Lifetime (L80)	30,000 h
On-/Off-cycles	100,000
Colour consistency (SDCM)	4
Dimmability	On-Off
Sensor type	No / Motion + Daylight detection (MD)
Sensor technology	No / Microwave
Beam angle	120°
Finishing	Grey RAL 7035
Colour rendering index (CRI)	≥ 80
Degree of protection (IP)	IP65
Impact strength	IK08
Protection class	I
Risk group (EN 62471)	RG0
With control gear	Yes
Glow wire test	850°C
Driver failure rate (at 5,000 hrs)	<0.5 %
Power factor	≥ 0.9
Input wire diameter	1mm ² - 2.5mm ²
Max. input cable diameter (mm)	5-11 mm

Electrical Supply

Frequency	50/60 Hz
Nominal voltage	220-240 V AC
DC input voltage	See catalogue appendix Connection Specifications

Mechanical Properties

Material housing	Polycarbonate
UV resistant	Yes
Optical material	Polycarbonate
Mounting clips	Stainless steel

Ambient Conditions

Operating temperature	-25-+40°C
Application temperature	+25°C
Storage environment	-30-+50°C



Dimensional Drawing (mm)

LEDWaterproof-CLA-E L650

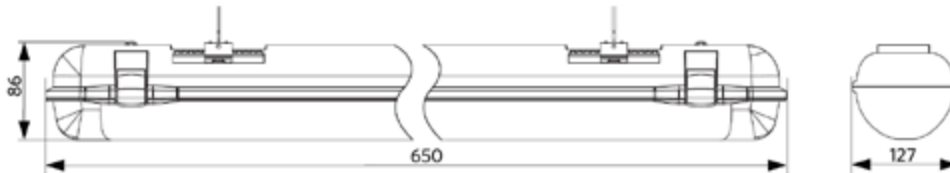

LEDWaterproof-CLA-E L1250

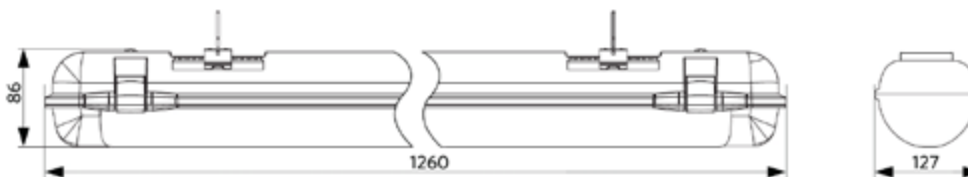

LEDWaterproof-CLA-E L1550

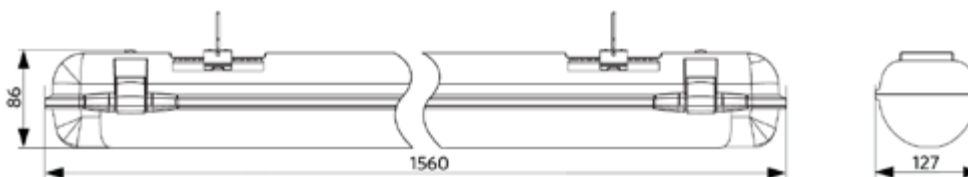

Installation Possibilities

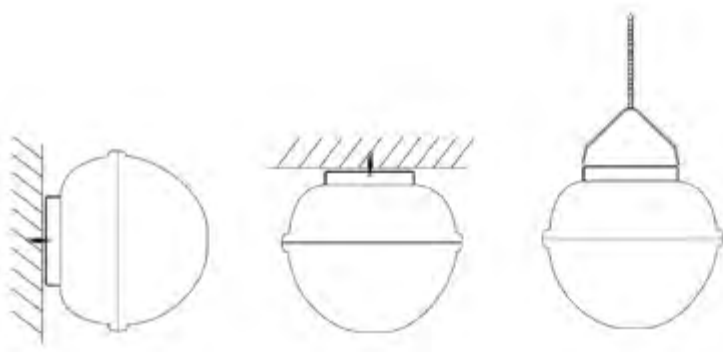

Motion sensors - Detection range

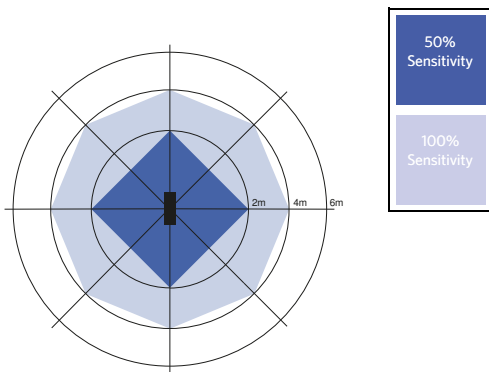

Installation - Ceiling mounted
Suggested installation height 3-4m





PRECAU
MILANO - 02 47 1 4 85 8

SMART

INDOOR

OUTDOOR

LAMPS & TOOLS

TECHNICAL DATA

GLOSSARY





Waterproof EcoMax G2

- Waterproof luminaire in "sealed-for-life" concept
- Quick installation through the easy to open endcap
- 3 lengths and 6 lumen packages, with efficacy of 130 lm/W
- Up to 50% lower energy consumption compared to traditional TL lighting
- Supplied with vandal-proof stainless steel ceiling and suspension clips
- Equipped with 3x2.5mm² throughwiring



Specifications

Item Code	Item Description	Equivalent to (W)	Power (W)	Lumen	Efficacy (lm/W)	CCT (K)	Internal wiring (mm ²)	Weight (kg/pc)
On-Off								
543022012600	LEDWaterproof-E2 L680-10W-4000	TL 1x18W	10	1300	130	4000	3x2.5	0.56
543022012500	LEDWaterproof-E2 L680-20W-4000	TL 2x18W	20	2600	130	4000	3x2.5	0.65
543022012400	LEDWaterproof-E2 L1260-18W-4000	TL 1x36W	18	2340	130	4000	3x2.5	0.97
543022012300	LEDWaterproof-E2 L1260-37W-4000	TL 2x36W	37	4810	130	4000	3x2.5	0.99
543022012200	LEDWaterproof-E2 L1260-37W-6500	TL 2x36W	37	4810	130	6500	3x2.5	0.99
543022012100	LEDWaterproof-E2 L1540-27W-4000	TL 1x58W	27	3510	130	4000	3x2.5	1.16
543022012000	LEDWaterproof-E2 L1540-50W-4000	TL 2x58W	50	6500	130	4000	3x2.5	1.19
543022011900	LEDWaterproof-E2 L1540-50W-6500	TL 2x58W	50	6500	130	6500	3x2.5	1.19

Technical Specifications	
Lifetime (L70)	50,000 h
Lifetime (L80)	30,000 h
On-/Off-cycles	100,000
Colour consistency (SDCM)	4
Dimmability	On-Off
Beam angle	120°
Finishing	Grey RAL 7035
Colour rendering index (CRI)	≥ 80
Degree of protection (IP)	IP66
Impact strength	IK08
Protection class	II
Risk group (EN 62471)	RG0
With control gear	Yes
Glow wire test	850°C
Driver failure rate (at 5,000 hrs)	<0.5 %
Power factor	≥ 0.9
Input wire diameter	1mm ² - 2.5mm ²
Max. input cable diameter (mm)	7-11.5 mm

Electrical Supply	
Frequency	50/60 Hz
Nominal voltage	220-240 V AC
DC input voltage	No

Mechanical Properties	
Material housing	Polycarbonate
UV resistant	Yes
Optical material	Polycarbonate
Mounting clips	Stainless steel

Ambient Conditions	
Operating temperature	-20-+45°C
Application temperature	+25°C
Storage environment	-30-+50°C



Dimensional Drawing (mm)

LEDWaterproof-E2 L680

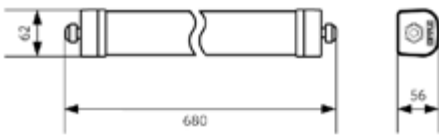

LEDWaterproof-E2 L1260

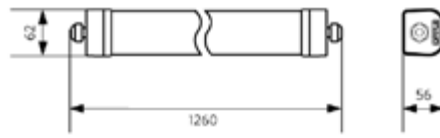

LEDWaterproof-E2 L1540

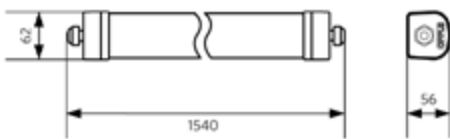

Installation Possibilities

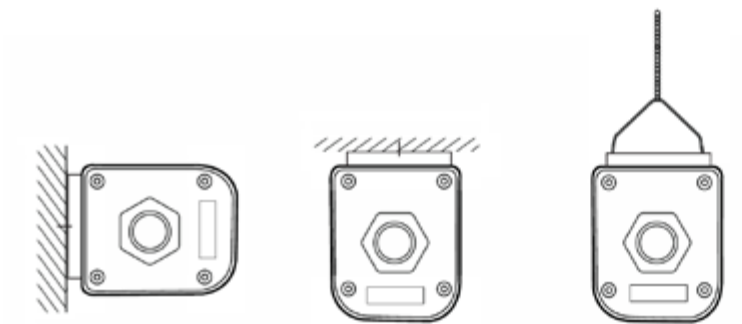



Waterproof Basic

- Cost effective "sealed-for-life" waterproof luminaire
- High efficacy of 125 lm/w
- Available with wirethrough (WT) for faster installation
- Available in two CCTs (4000K/6500K)
- Up to 60% lower energy consumption compared to traditional TL lighting
- Quick installation through the easy to open endcap
- Supplied with stainless steel ceiling and suspension clips



Specifications

Item Code	Item Description	Equivalent to (W)	Power (W)	Lumen	Efficacy (lm/W)	CCT (K)	Wirethrough	Internal wiring (mm ²)	Weight (kg/pc)
On-Off									
543022006400	LEDWaterproof-B L1150-36W-4000	TL 2x36W	36	4500	125	4000	No	2x1.5	1.40
543022017500	LEDWaterproof-B L1150-36W-4000-WT	TL 2x36W	36	4500	125	4000	Yes	2x1.5	0.98
543022017900	LEDWaterproof-B L1150-36W-6500	TL 2x36W	36	4500	125	6500	No	2x1.5	0.86
543022017700	LEDWaterproof-B L1150-36W-6500-WT	TL 2x36W	36	4500	125	6500	Yes	2x1.5	0.98
543022006500	LEDWaterproof-B L1450-50W-4000	TL 2x58W	50	6250	125	4000	No	2x1.5	1.70
543022017600	LEDWaterproof-B L1450-50W-4000-WT	TL 2x58W	50	6250	125	4000	Yes	2x1.5	1.16
543022018000	LEDWaterproof-B L1450-50W-6500	TL 2x58W	50	6250	125	6500	No	2x1.5	1.04
543022017800	LEDWaterproof-B L1450-50W-6500-WT	TL 2x58W	50	6250	125	6500	Yes	2x1.5	1.16

Technical Specifications	
Lifetime (L70)	30,000 h
Lifetime (L80)	20,000 h
On-/Off-cycles	100,000
Colour consistency (SDCM)	4
Dimmability	On-Off
Beam angle	110°
Finishing	Grey RAL 7035
Colour rendering index (CRI)	≥ 80
Degree of protection (IP)	IP65
Impact strength	IK08
Protection class	II
Risk group (EN 62471)	RG0
With control gear	Yes
Glow wire test	850°C
Driver failure rate (at 5,000 hrs)	<0.5 %
Power factor	≥ 0.9
Max. input cable diameter (mm)	7-9 mm

Electrical Supply	
Frequency	50/60 Hz
Nominal voltage	220-240 V AC
DC input voltage	No

Mechanical Properties	
Material housing	Polycarbonate
UV resistant	Yes
Optical material	Polycarbonate
Mounting clips	Stainless steel

Ambient Conditions	
Operating temperature	-20-+45°C
Application temperature	+25°C
Storage environment	-25-+50°C



Dimensional Drawing (mm)

LEDWaterproof-B L1150



LEDWaterproof-B L1450



LEDWaterproof-B L1150
-WT



LEDWaterproof-B L1450
-WT



Installation Possibilities

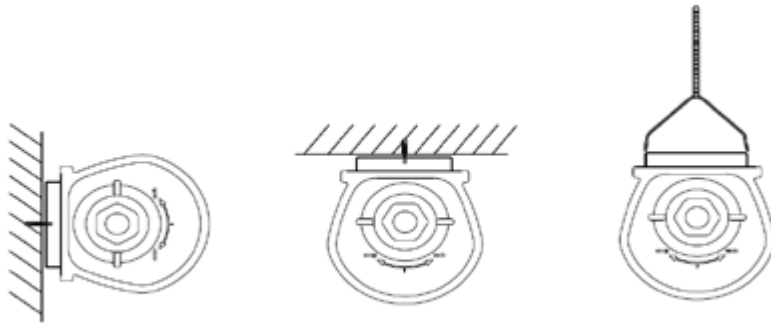



Trunking

- Professional LED light line solution
- Simple installation with snap-in mounting of LED modules and trunks
- Huge energy saving up to 65% compared to conventional TL lighting
- Very high efficacy of 160 lm/W
- Multiple beam angles (60°, 90°, 120° & BW) and powers available
- Extra energy saving by using DALI dimmable LED modules and fully customisable DALI sensors
- Integration of 3C Spots possible with 3C Track Module accessory



Trunking Configurator
trunkingconfigurator.opple.com

Specifications

Item Code	Item Description	Equivalent to (W)	Power (W)	Lumen	Efficacy (lm/W)	CCT (K)	Beam angle	Weight (kg/pc)
On-Off								
542005008200	LEDTrunking Module L15-35W-4000-120	TL 2x58W	35	5600	160	4000	120°	1.64
542005006000	LEDTrunking Module L15-50W-4000-60	TL 2x80W	50	8000	160	4000	60°	1.64
542005005900	LEDTrunking Module L15-50W-4000-90	TL 2x80W	50	8000	160	4000	90°	1.64
542005005800	LEDTrunking Module L15-50W-4000-120	TL 2x80W	50	8000	160	4000	120°	1.64
542005006100	LEDTrunking Module L15-50W-4000-BW	TL 2x80W	50	8000	160	4000	Batwing	1.64
542005006400	LEDTrunking Module L15-70W-4000-60	2x TLM 140W RS	70	11200	160	4000	60°	1.71
542005006300	LEDTrunking Module L15-70W-4000-90	2x TLM 140W RS	70	11200	160	4000	90°	1.71
542005006200	LEDTrunking Module L15-70W-4000-120	2x TLM 140W RS	70	11200	160	4000	120°	1.71
542005006500	LEDTrunking Module L15-70W-4000-BW	2x TLM 140W RS	70	11200	160	4000	Batwing	1.71
DALI								
542005008600	LEDTrunking Module L15-35W-4000-120-DALI	TL 2x58W	35	5600	160	4000	120°	1.64
542005006800	LEDTrunking Module L15-50W-4000-60-DALI	TL 2x80W	50	8000	160	4000	60°	1.64
542005006700	LEDTrunking Module L15-50W-4000-90-DALI	TL 2x80W	50	8000	160	4000	90°	1.64
542005006600	LEDTrunking Module L15-50W-4000-120-DALI	TL 2x80W	50	8000	160	4000	120°	1.64
542005006900	LEDTrunking Module L15-50W-4000-BW-DALI	TL 2x80W	50	8000	160	4000	Batwing	1.64
542005007200	LEDTrunking Module L15-70W-4000-60-DALI	2x TLM 140W RS	70	11200	160	4000	60°	1.71
542005007100	LEDTrunking Module L15-70W-4000-90-DALI	2x TLM 140W RS	70	11200	160	4000	90°	1.71
542005007000	LEDTrunking Module L15-70W-4000-120-DALI	2x TLM 140W RS	70	11200	160	4000	120°	1.71
542005007300	LEDTrunking Module L15-70W-4000-BW-DALI	2x TLM 140W RS	70	11200	160	4000	Batwing	1.71
Emergency version 1 hour, On-Off								
549004007010	LEDTrunk Mod L15-35W-4000-120-EM1	TL 2x58W	35	5600	160	4000	120°	1.94
549004007210	LEDTrunk Mod L15-50W-4000-60-EM1	TL 2x80W	50	8000	160	4000	60°	1.94
549004007610	LEDTrunk Mod L15-50W-4000-90-EM1	TL 2x80W	50	8000	160	4000	90°	1.94
549004005510	LEDTrunk Mod L15-50W-4000-120-EM1	TL 2x80W	50	8000	160	4000	120°	1.94
549004004110	LEDTrunk Mod L15-50W-4000-BW-EM1	TL 2x80W	50	8000	160	4000	Batwing	1.94
549004007410	LEDTrunk Mod L15-70W-4000-60-EM1	2x TLM 140W RS	70	11200	160	4000	60°	2.01
549004007510	LEDTrunk Mod L15-70W-4000-90-EM1	2x TLM 140W RS	70	11200	160	4000	90°	2.01
549004007310	LEDTrunk Mod L15-70W-4000-120-EM1	2x TLM 140W RS	70	11200	160	4000	120°	2.01
549004008010	LEDTrunk Mod L15-70W-4000-BW-EM1	2x TLM 140W RS	70	11200	160	4000	Batwing	2.01



Item Code	Item Description	Equivalent to (W)	Power (W)	Lumen	Efficacy (lm/W)	CCT (K)	Beam angle	Weight (kg/pc)
Emergency version 1 hour, DALI								
549004006910	LEDTrunk Mod L15-35W-4000-120-DALI-EM1	TL 2x58W	35	5600	160	4000	120°	1.94
549004005610	LEDTrunk Mod L15-50W-4000-60-DALI-EM1	TL 2x80W	50	8000	160	4000	60°	1.94
549004006310	LEDTrunk Mod L15-50W-4000-90-DALI-EM1	TL 2x80W	50	8000	160	4000	90°	1.94
549004007110	LEDTrunk Mod L15-50W-4000-120-DALI-EM1	TL 2x80W	50	8000	160	4000	120°	1.94
549004004210	LEDTrunk Mod L15-50W-4000-BW-DALI-EM1	TL 2x80W	50	8000	160	4000	Batwing	1.94
549004006410	LEDTrunk Mod L15-70W-4000-60-DALI-EM1	2x TLM 140W RS	70	11200	160	4000	60°	2.01
549004006210	LEDTrunk Mod L15-70W-4000-90-DALI-EM1	2x TLM 140W RS	70	11200	160	4000	90°	2.01
549004006510	LEDTrunk Mod L15-70W-4000-120-DALI-EM1	2x TLM 140W RS	70	11200	160	4000	120°	2.01
549004006110	LEDTrunk Mod L15-70W-4000-BW-DALI-EM1	2x TLM 140W RS	70	11200	160	4000	Batwing	2.01
Emergency version 3 hours, On-Off								
549004004610	LEDTrunk Mod L15-35W-4000-120-EM3	TL 2x58W	35	5600	160	4000	120°	2.04
549004005910	LEDTrunk Mod L15-50W-4000-60-EM3	TL 2x80W	50	8000	160	4000	60°	2.04
549004005710	LEDTrunk Mod L15-50W-4000-90-EM3	TL 2x80W	50	8000	160	4000	90°	2.04
549004006810	LEDTrunk Mod L15-50W-4000-120-EM3	TL 2x80W	50	8000	160	4000	120°	2.04
549004005810	LEDTrunk Mod L15-50W-4000-BW-EM3	TL 2x80W	50	8000	160	4000	Batwing	2.04
549004004810	LEDTrunk Mod L15-70W-4000-60-EM3	2x TLM 140W RS	70	11200	160	4000	60°	2.11
549004006710	LEDTrunk Mod L15-70W-4000-90-EM3	2x TLM 140W RS	70	11200	160	4000	90°	2.11
549004006010	LEDTrunk Mod L15-70W-4000-120-EM3	2x TLM 140W RS	70	11200	160	4000	120°	2.11
549004004010	LEDTrunk Mod L15-70W-4000-BW-EM3	2x TLM 140W RS	70	11200	160	4000	Batwing	2.11
Emergency version 3 hours, DALI								
549004004510	LEDTrunk Mod L15-35W-4000-120-DALI-EM3	TL 2x58W	35	5600	160	4000	120°	2.04
549004005310	LEDTrunk Mod L15-50W-4000-60-DALI-EM3	TL 2x80W	50	8000	160	4000	60°	2.04
549004005410	LEDTrunk Mod L15-50W-4000-90-DALI-EM3	TL 2x80W	50	8000	160	4000	90°	2.04
549004006610	LEDTrunk Mod L15-50W-4000-120-DALI-EM3	TL 2x80W	50	8000	160	4000	120°	2.04
549004005210	LEDTrunk Mod L15-50W-4000-BW-DALI-EM3	TL 2x80W	50	8000	160	4000	Batwing	2.04
549004004910	LEDTrunk Mod L15-70W-4000-60-DALI-EM3	2x TLM 140W RS	70	11200	160	4000	60°	2.11
549004005010	LEDTrunk Mod L15-70W-4000-90-DALI-EM3	2x TLM 140W RS	70	11200	160	4000	90°	2.11
549004005110	LEDTrunk Mod L15-70W-4000-120-DALI-EM3	2x TLM 140W RS	70	11200	160	4000	120°	2.11
549004004710	LEDTrunk Mod L15-70W-4000-BW-DALI-EM3	2x TLM 140W RS	70	11200	160	4000	Batwing	2.11
Trunks								
542098002100	LEDTrunking Trunk 8 L15							1.75
542098002200	LEDTrunking Trunk 8 L15 End Part							1.42
542098002300	LEDTrunking Trunk 8 L30							3.20
542098002400	LEDTrunking Trunk 8 L30 End Part							3.00

DALI versions are compatible with central emergency lighting according to EN 50172.
For more technical information, please go to the appendix.

Accessories



542098001300
LEDTrunking Feed-in Box 8



542098011200
LEDTrunking Feed-out Box 8



542098001500
LEDTrunking Feed-in Connector 8



542098004600
LEDTrunking Sensor Probe L



542098001100
LEDTrunking Sensor Cover L15



542098001000
LEDTrunking DALI Power Supply

542098003000
LEDTrunking Cable Gland

542098004700
LEDTrunking Sensor Probe H



542098001700
LEDTrunking End Cap



542098001800
LEDTrunking Cover L15



542098011000
LEDTrunking Cover End Cap



542098012700
LEDTrunking 3C Track Module



542098001900
LEDTrunking Mounting Clip Chain



542098002000
LEDTrunking Cord-3m



542098002900
LEDTrunking Mounting Clip

5 YEARS WARRANTY



Technical Specifications	
Lifetime (L70)	70,000 h
Lifetime (L80)	60,000 h
Lifetime (L90)	50,000 h
On-/Off-cycles	100,000
Dimmability	On-Off / DALI
Finishing	White
Colour rendering index (CRI)	≥ 80
Degree of protection (IP)	IP20
Impact strength	IK02
Protection class	I
Risk group (EN 62471)	RG0
With control gear	Yes
Power factor	≥ 0.9

Electrical Supply	
Frequency	50/60 Hz
Nominal voltage	220-240 V AC
DC input voltage	See catalogue appendix Connection Specifications

Mechanical Properties	
Housing material	Steel

Ambient Conditions	
Operating temperature	-25-+40°C
Application temperature	+25°C
Storage environment	-25-+50°C

Dimensional Drawing (mm)

LEDTrunking Mod

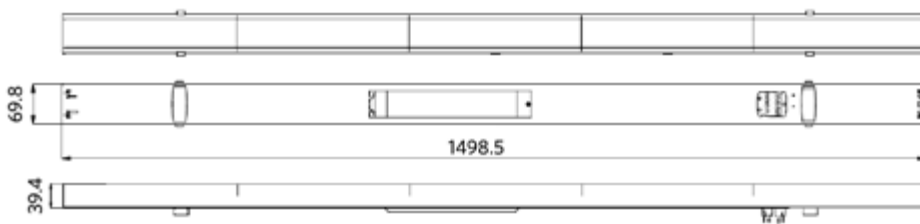

LEDTrunking Trunk 8

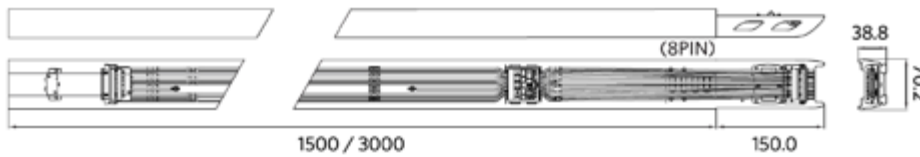

LEDTrunking Trunk 8
End part

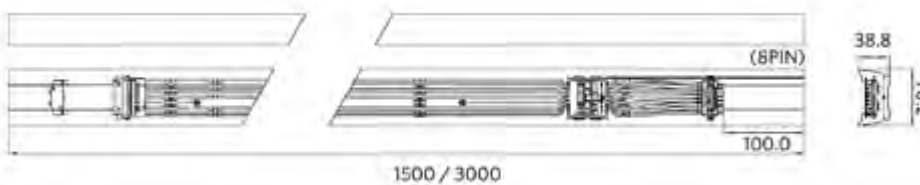

Motion sensors - Detection range

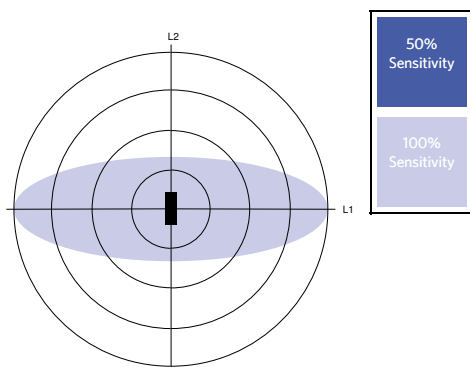

Installation - Ceiling Mounted

Installation height (m)	Sensor Probe L (m) (L1xL2)	Sensor Probe H (m) (L1xL2)
3	5.0x2.2	-
4	4.5x2.2	6.7x2.9
5	4.0x2.1	8.4x3.6
6	-	10.0x4.4
7	-	9.0x3.9
8	-	8.0x3.6
9	-	7.0x3.2
10	-	6.0x2.8





SMART

INDOOR

OUTDOOR

LAMPS & TOOLS

TECHNICAL DATA

GLOSSARY







Smart 12
Indoor 30
Outdoor 120
Lamps & Tools 150
Technical Data 164
Glossary 182







Roadlight Stratus

- Modern-looking Roadlight solution with advanced optical design
- Complete Roadlight family from 60W to 150W
- DALI2 versions equipped with midnight dimming (configuration module needed)
- Available with D4i-Driver and Zhaga connector for easy integration in Smart City Control Systems
- Easy installation and maintenance via openable driver compartment
- Flexible and adjustable pole connector (60mm & 76mm) for both side entry and pole top mounting (order separately)



Specifications

Item Code	Item Description	Equivalent to (W)	Power (W)	Lumen	Efficacy (lm/W)	CCT (K)	Weight (kg/pc)	Mandatory pole adapter	
On-Off									
705000067400	LEDRoad-St-P2 Re489-60W-730	HID 100W	60	9000	150	3000	4.90		
705000068800	LEDRoad-St-P2 Re489-60W-740	HID 100W	60	9000	150	4000	4.90		
705000066800	LEDRoad-St-P2 Re489-80W-730	HID 150W	80	12000	150	3000	4.90		
705000068000	LEDRoad-St-P2 Re489-80W-740	HID 150W	80	12000	150	4000	4.90		
705000068200	LEDRoad-St-P2 Re588-120W-730	HID 150W	120	18000	150	3000	7.30		
705000066600	LEDRoad-St-P2 Re588-120W-740	HID 150W	120	18000	150	4000	7.30		
705000067700	LEDRoad-St-P2 Re588-150W-730	HID 250W	150	22500	150	3000	7.30		
705000068100	LEDRoad-St-P2 Re588-150W-740	HID 250W	150	22500	150	4000	7.30		
DALI2, D4i									
705000068600	LEDRoad-St-P2 Re489-60W-DALI-730	HID 100W	60	9000	150	3000	4.90		
705000067000	LEDRoad-St-P2 Re489-60W-DALI-740	HID 100W	60	9000	150	4000	4.90		
705000067900	LEDRoad-St-P2 Re489-80W-DALI-730	HID 150W	80	12000	150	3000	4.90		
705000067300	LEDRoad-St-P2 Re489-80W-DALI-740	HID 150W	80	12000	150	4000	4.90		
705000067800	LEDRoad-St-P2 Re588-120W-DALI-730	HID 150W	120	18000	150	3000	7.30		
705000068300	LEDRoad-St-P2 Re588-120W-DALI-740	HID 150W	120	18000	150	4000	7.30		
705000067200	LEDRoad-St-P2 Re588-150W-DALI-730	HID 250W	150	22500	150	3000	7.30		
705000067600	LEDRoad-St-P2 Re588-150W-DALI-740	HID 250W	150	22500	150	4000	7.30		
DALI2, D4i, Zhaga									
705000066900	LEDRoad-St-P2 Re489-60W-DALI-730-ZH	HID 100W	60	9000	150	3000	4.90		
705000067500	LEDRoad-St-P2 Re489-60W-DALI-740-ZH	HID 100W	60	9000	150	4000	4.90		
705000066700	LEDRoad-St-P2 Re489-80W-DALI-730-ZH	HID 150W	80	12000	150	3000	4.90		
705000068700	LEDRoad-St-P2 Re489-80W-DALI-740-ZH	HID 150W	80	12000	150	4000	4.90		
705000068500	LEDRoad-St-P2 Re588-120W-DALI-730-ZH	HID 150W	120	18000	150	3000	7.30		
705000068400	LEDRoad-St-P2 Re588-120W-DALI-740-ZH	HID 150W	120	18000	150	4000	7.30		
705000067100	LEDRoad-St-P2 Re588-150W-DALI-730-ZH	HID 250W	150	22500	150	3000	7.30		
705000068900	LEDRoad-St-P2 Re588-150W-DALI-740-ZH	HID 250W	150	22500	150	4000	7.30		

For more technical information, please go to the appendix.



Accessories

Mandatory



705098008300
Pole Adapter-Road-St-P2-60mm

Mandatory



705098008400
Pole Adapter-Road-St-P2-76mm

or



705098003600
LEDStreetlight Wall-Bracket-60



705098003700
LEDStreetlight Pole-Top-60-Adapter-60



705098003400
LEDStreetlight Pole-Top-76-Adapter-60



705098005500
LEDStreetlight Pole-Top-60-Adapter-2x60

Technical Specifications

Lifetime (L80)	100,000 h
On-/Off-cycles	100,000
Colour consistency (SDCM)	5
Dimmability	On-Off / DALI2
Beam angle	143° x 70°
Maximum tilt angle	-15-+15°
Finishing	Grey RAL 870-3
Colour rendering index (CRI)	≥ 70
Degree of protection (IP)	IP66
Impact strength	IK08
Protection class	II
Risk group (EN 62471)	RG0
With control gear	Yes
Glow wire test	850°C
Driver failure rate (at 5,000 hrs)	<0.5 %
Power factor	≥ 0.9
Surge protection	10 kV

Electrical Supply

Frequency	50/60 Hz
Nominal voltage	220-240 V AC
DC input voltage	See catalogue appendix
Connection	Specifications

Mechanical Properties

Housing material	Aluminium
Optical material	Polycarbonate
Compatible pole Ø	48-76 mm
Effective wind area	1300 cm ² / 1800 cm ²
Coastal proof	Yes

Ambient Conditions

Operating temperature	-25-+45°C
Application temperature	+25°C
Storage environment	-40-+60°C



Dimensional Drawing (mm)

LEDRoad-St-P2 Re489
On-Off & DALI2

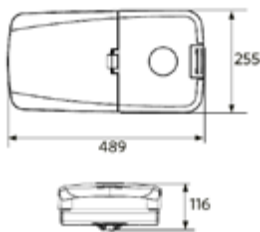

Pole Adapter-Road-St-P2-60mm

LEDRoad-St-P2 Re489
Zhaga

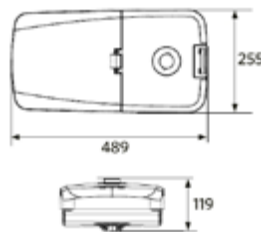

Pole Adapter-Road-St-P2-76mm

LEDRoad-St-P2 Re588
On-Off & DALI2

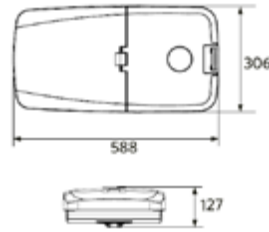

LEDRoad-St-P2 Re588
Zhaga

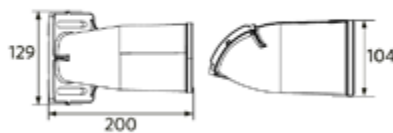
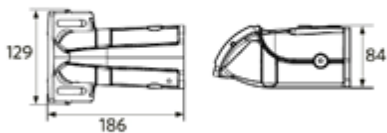
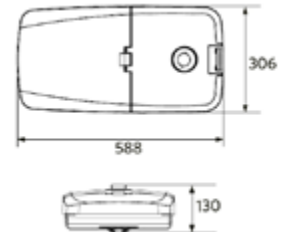



- Sleek and compact Roadlight solution
- Up to 60% energy saving compared to traditional roadlights
- Advanced optical design optimized for road lighting
- High efficacy up to 125 lm/W
- Accessories available for many pole types and connections
- Robust die-cast aluminium body
- IP66 and suitable for use on coastal applications

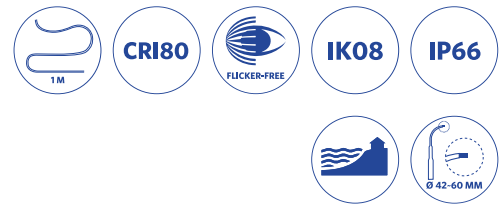

Specifications

Item Code	Item Description	Equivalent to (W)	Power (W)	Lumen	Efficacy (lm/W)	CCT (K)	Weight (kg/pc)
On-Off							
705000021300	LEDRoadlight-E 80W-3000	HID 150W	80	9500	118	3000	3.27
705000021800	LEDRoadlight-E 80W-4000	HID 150W	80	10000	125	4000	3.27
705000021400	LEDRoadlight-E 100W-3000	HID 150W	100	11600	116	3000	3.27
705000021900	LEDRoadlight-E 100W-4000	HID 150W	100	12500	125	4000	3.27

For more technical information, please go to the appendix.

Accessories



705098003600
LEDStreetlight Wall-Bracket-60



705098003500
LEDStreetlight 76-Adapter-60



705098003700
LEDStreetlight Pole-Top-60-Adapter-60



705098003400
LEDStreetlight Pole-Top-76-Adapter-60



705098005500
LEDStreetlight Pole-Top-60-Adapter-2x60



599000004600
LEDStreet-SE-ExtensionCable-6m



543098021900
LEDFixture-IP68-Connector-Kit-3



5 YEARS WARRANTY



Technical Specifications

Lifetime (L70)	70,000 h
Lifetime (L80)	50,000 h
On-/Off-cycles	100,000
Colour consistency (SDCM)	4
Dimmability	On-Off
Beam angle	150° x 80°
Finishing	Grey RAL 870-3
Colour rendering index (CRI)	≥ 80
Degree of protection (IP)	IP66
Impact strength	IK08
Protection class	I
Risk group (EN 62471)	RG1
With control gear	Yes
Glow wire test	850°C
Driver failure rate (at 5,000 hrs)	<0.5 %
Power factor	≥ 0.9
Surge protection	6 kV

Electrical Supply

Frequency	50/60 Hz
Nominal voltage	220-240 V AC
DC input voltage	See catalogue appendix Connection Specifications
230V Cable length	1 m

Mechanical Properties

Housing material	Aluminium
Optical material	Polycarbonate
Compatible pole Ø	42-60 mm
Effective wind area	900 cm ²
Coastal proof	Yes

Ambient Conditions

Operating temperature	-40-+50°C
Application temperature	+25°C
Storage environment	-30-+60°C

Dimensional Drawing (mm)

LEDRoadlight-E

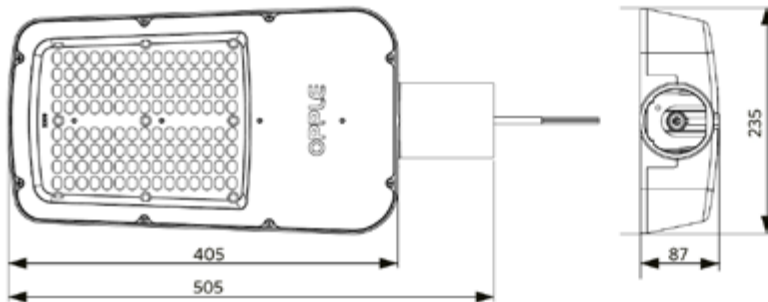



Streetlight G2

- Design streetlight luminaire with optimised optical configuration
- Up to 60% energy saving compared to traditional streetlights
- High efficacy up to 125 lm/W
- Available also with Daylight Detection Sensor (DD, 4000K)
- Accessories available for many pole types and connections
- IP66 and suitable for use on coastal applications
- Now with 42-60mm pole entry

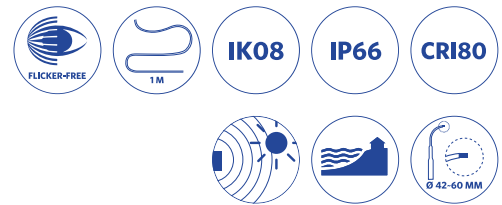

Specifications

Item Code	Item Description	Equivalent to (W)	Power (W)	Lumen	Efficacy (lm/W)	CCT (K)	Weight (kg/pc)
On-Off							
705000021000	LEDStreetlight-E2 20W-3000	HID 50W	20	2300	115	3000	1.27
705000021500	LEDStreetlight-E2 20W-4000	HID 50W	20	2500	125	4000	1.27
705000021100	LEDStreetlight-E2 40W-3000	HID 70W	40	4700	118	3000	1.27
705000021600	LEDStreetlight-E2 40W-4000	HID 70W	40	5000	125	4000	1.27
705000021200	LEDStreetlight-E2 60W-3000	HID 100W	60	7100	118	3000	1.27
705000021700	LEDStreetlight-E2 60W-4000	HID 100W	60	7500	125	4000	1.27
Daylight Detection							
705000022000	LEDStreetlight-E2 20W-4000-DD	HID 50W	20	2500	125	4000	1.32
705000022100	LEDStreetlight-E2 40W-4000-DD	HID 70W	40	5000	125	4000	1.32
705000022200	LEDStreetlight-E2 60W-4000-DD	HID 100W	60	7500	125	4000	1.32

For more technical information, please go to the appendix.

Accessories



705098003600
LEDStreetlight Wall-Bracket-60



705098003500
LEDStreetlight 76-Adapter-60



705098003700
LEDStreetlight Pole-Top-60-Adapter-60



705098003400
LEDStreetlight Pole-Top-76-Adapter-60



705098005500
LEDStreetlight Pole-Top-60-Adapter-2x60



543098021900
LEDFixture-IP68-Connector-Kit-3



599000004600
LEDStreet-SE-ExtensionCable-6m



5 YEARS WARRANTY



Technical Specifications

Lifetime (L70)	70,000 h
Lifetime (L80)	50,000 h
On-/Off-cycles	100,000
Colour consistency (SDCM)	4
Dimmability	On-Off
Sensor type	No / Daylight detection (DD)
Sensor technology	No / Illumination sensor
Beam angle	145° x 80°
Finishing	Grey RAL 870-3
Colour rendering index (CRI)	≥ 80
Degree of protection (IP)	IP66
Impact strength	IK08
Protection class	I
Risk group (EN 62471)	RG1
With control gear	Yes
Glow wire test	850°C
Driver failure rate (at 5,000 hrs)	<0.5 %
Power factor	≥ 0.9
Surge protection	4 kV

Electrical Supply

Frequency	50/60 Hz
Nominal voltage	220-240 V AC
DC input voltage	See catalogue appendix Connection Specifications
230V Cable length	1 m

Mechanical Properties

Housing material	Aluminium
Optical material	Polycarbonate
Compatible pole Ø	42-60 mm
Effective wind area	400 cm ²
Coastal proof	Yes

Ambient Conditions

Operating temperature	-40-+50°C
Application temperature	+25°C
Storage environment	-30-+60°C

Dimensional Drawing (mm)

LEDStreetlight-E2

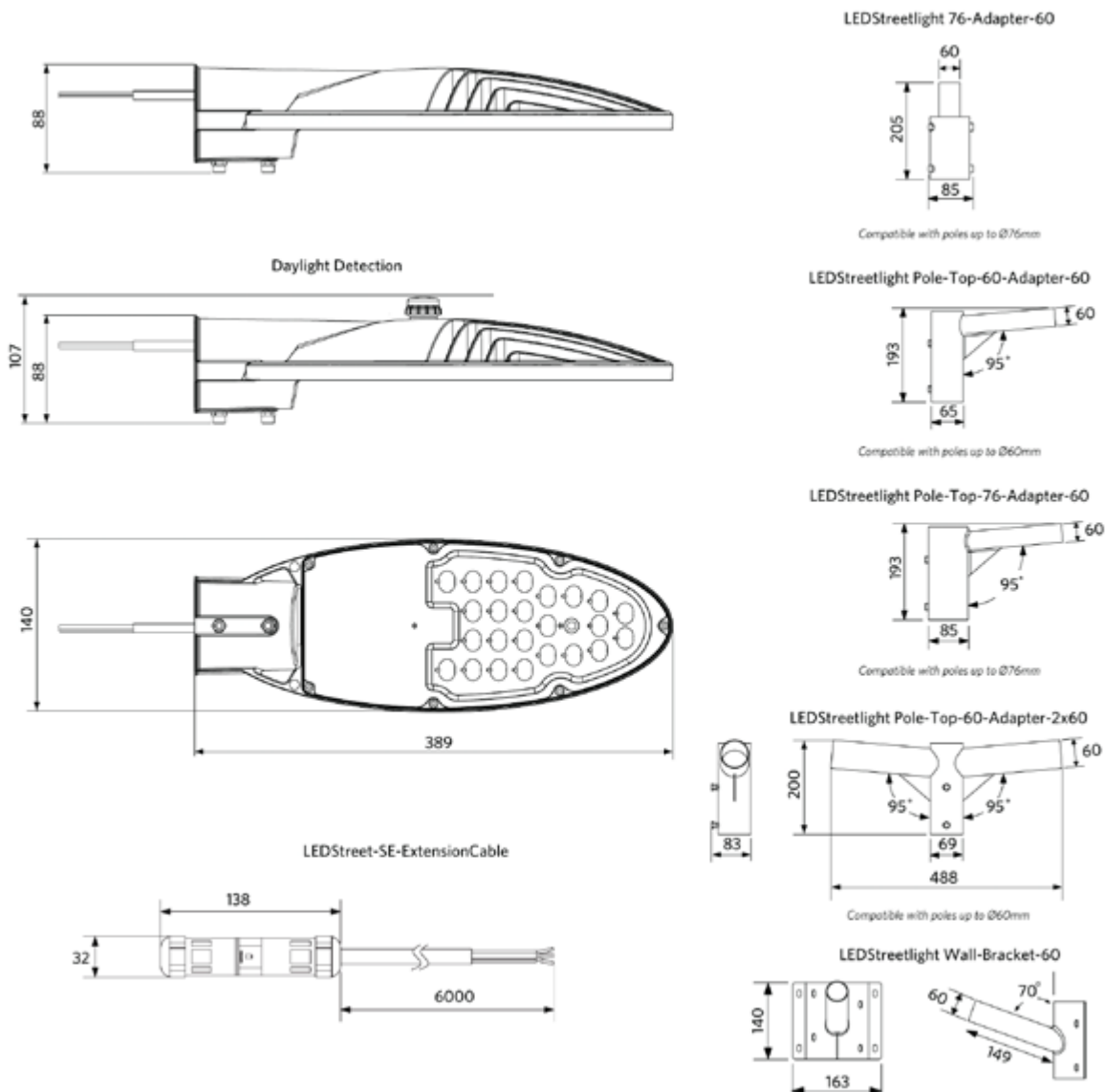



**NEW
VERSIONS**

- NEW: DALI2 versions available for 33W and 50W
- Professional post-top solution with optimal light performance
- Integrates well into existing landscape
- Different optics to suit the application and reduce glare
- Die casted aluminium body for optimal heat dissipation
- Available in two pole sizes for more application flexibility
- IP66 and suitable for use on coastal applications



Specifications

Item Code	Item Description	Equivalent to (W)	Power (W)	Lumen	Efficacy (lm/W)	CCT (K)	Beam angle	Compatible pole Ø (mm)	Weight (kg/pc)
On-Off									
543016006000	LEDPostTop-P 33W-3000-W	HID 50W	33	4300	130	3000	160°	60 mm	7.68
708000000400	LEDPostTop-P 33W-3000-W-D76	HID 50W	33	4300	130	3000	160°	76 mm	7.68
543016005700	LEDPostTop-P 33W-3000-AS	HID 50W	33	4000	120	3000	45° x 150°	60 mm	7.68
708000000100	LEDPostTop-P 33W-3000-AS-D76	HID 50W	33	4000	120	3000	45° x 150°	76 mm	7.68
543016006600	LEDPostTop-P 33W-4000-W	HID 50W	33	4500	135	4000	160°	60 mm	7.68
708000001000	LEDPostTop-P 33W-4000-W-D76	HID 50W	33	4500	135	4000	160°	76 mm	7.68
543016006300	LEDPostTop-P 33W-4000-AS	HID 50W	33	4100	125	4000	50° x 150°	60 mm	7.68
708000000700	LEDPostTop-P 33W-4000-AS-D76	HID 50W	33	4100	125	4000	50° x 150°	76 mm	7.68
543016006100	LEDPostTop-P 50W-3000-W	HID 70W	50	6500	130	3000	155°	60 mm	7.72
708000000500	LEDPostTop-P 50W-3000-W-D76	HID 70W	50	6500	130	3000	155°	76 mm	7.72
543016005800	LEDPostTop-P 50W-3000-AS	HID 70W	50	6000	120	3000	40° x 150°	60 mm	7.72
708000000200	LEDPostTop-P 50W-3000-AS-D76	HID 70W	50	6000	120	3000	40° x 150°	76 mm	7.72
543016006700	LEDPostTop-P 50W-4000-W	HID 70W	50	6800	135	4000	155°	60 mm	7.72
708000001100	LEDPostTop-P 50W-4000-W-D76	HID 70W	50	6800	135	4000	155°	76 mm	7.72
543016006400	LEDPostTop-P 50W-4000-AS	HID 70W	50	6300	125	4000	40° x 150°	60 mm	7.72
708000000800	LEDPostTop-P 50W-4000-AS-D76	HID 70W	50	6300	125	4000	40° x 150°	76 mm	7.72
543016006200	LEDPostTop-P 68W-3000-W	HID 100W	68	8800	130	3000	155°	60 mm	7.91
708000000600	LEDPostTop-P 68W-3000-W-D76	HID 100W	68	8800	130	3000	155°	76 mm	7.91
543016005900	LEDPostTop-P 68W-3000-AS	HID 100W	68	8200	120	3000	40° x 150°	60 mm	7.91
708000000300	LEDPostTop-P 68W-3000-AS-D76	HID 100W	68	8200	120	3000	40° x 150°	76 mm	7.91
543016006800	LEDPostTop-P 68W-4000-W	HID 100W	68	9200	135	4000	155°	60 mm	7.91
708000001200	LEDPostTop-P 68W-4000-W-D76	HID 100W	68	9200	135	4000	155°	76 mm	7.91
543016006500	LEDPostTop-P 68W-4000-AS	HID 100W	68	8500	125	4000	40° x 150°	60 mm	7.91
708000000900	LEDPostTop-P 68W-4000-AS-D76	HID 100W	68	8500	125	4000	40° x 150°	76 mm	7.91
DALI2									
708000003900	LEDPostTop-P 33W-DALI-730-W	HID 50W	33	4300	130	3000	160°	60 mm	7.68
708000004000	LEDPostTop-P 33W-DALI-730-W-D76	HID 50W	33	4300	130	3000	160°	76 mm	7.68
708000005300	LEDPostTop-P 33W-DALI-730-AS	HID 50W	33	4000	120	3000	50° x 150°	60 mm	7.68
708000003800	LEDPostTop-P 33W-DALI-730-AS-D76	HID 50W	33	4000	120	3000	50° x 150°	76 mm	7.68
708000004200	LEDPostTop-P 33W-DALI-740-W	HID 50W	33	4500	135	4000	160°	60 mm	7.68
708000004300	LEDPostTop-P 33W-DALI-740-W-D76	HID 50W	33	4500	135	4000	160°	76 mm	7.68
708000005200	LEDPostTop-P 33W-DALI-740-AS	HID 50W	33	4100	125	4000	50° x 150°	60 mm	7.68
708000004100	LEDPostTop-P 33W-DALI-740-AS-D76	HID 50W	33	4100	125	4000	50° x 150°	76 mm	7.68



Item Code	Item Description	Equivalent to (W)	Power (W)	Lumen	Efficacy (lm/W)	CCT (K)	Beam angle	Compatible pole Ø (mm)	Weight (kg/pc)
DALI2									
708000004600	LEDPostTop-P 50W-DALI-730-W	HID 70W	50	6500	130	3000	155°	60 mm	7.72
708000004700	LEDPostTop-P 50W-DALI-730-W-D76	HID 70W	50	6500	130	3000	155°	76 mm	7.72
708000004400	LEDPostTop-P 50W-DALI-730-AS	HID 70W	50	6000	120	3000	40° x 150°	60 mm	7.72
708000004500	LEDPostTop-P 50W-DALI-730-AS-D76	HID 70W	50	6000	120	3000	40° x 150°	76 mm	7.72
708000005000	LEDPostTop-P 50W-DALI-740-W	HID 70W	50	6800	135	4000	155°	60 mm	7.72
708000005100	LEDPostTop-P 50W-DALI-740-W-D76	HID 70W	50	6800	135	4000	155°	76 mm	7.72
708000004800	LEDPostTop-P 50W-DALI-740-AS	HID 70W	50	6300	125	4000	40° x 150°	60 mm	7.72
708000004900	LEDPostTop-P 50W-DALI-740-AS-D76	HID 70W	50	6300	125	4000	40° x 150°	76 mm	7.72

For more technical information, please go to the appendix.

Accessories



599000004600
LEDStreet-SE-ExtensionCable-6m

Technical Specifications

Lifetime (L70)	100,000 h
Lifetime (L80)	70,000 h
On-/Off-cycles	100,000
Colour consistency (SDCM)	5
Dimmability	On-Off / DALI2
Finishing	Grey RAL 870-3
Colour rendering index (CRI)	≥ 70
Degree of protection (IP)	IP66
Impact strength	IK08
Protection class	I
Risk group (EN 62471)	RG0
With control gear	Yes
Glow wire test	850°C
Driver failure rate (at 5,000 hrs)	<0.5 %
Power factor	≥ 0.9
Surge protection	10 kV

Electrical Supply

Frequency	50/60 Hz
Nominal voltage	220-240 V AC
DC input voltage	See catalogue appendix
Connection	Specifications

Mechanical Properties

Housing material	Aluminium
Optical material	Polycarbonate
Cover material	Tempered glass
Effective wind area	1590 cm ²
Coastal proof	Yes

Ambient Conditions

Operating temperature	-30-+50°C
Application temperature	+25°C
Storage environment	-40-+60°C

5 YEARS WARRANTY



Dimensional Drawing (mm)

LEDPostTop-P
D60

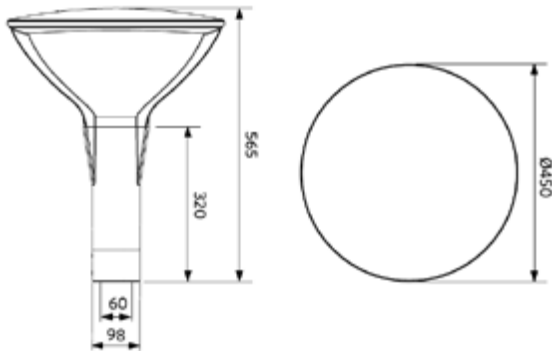

LEDPostTop-P
D76

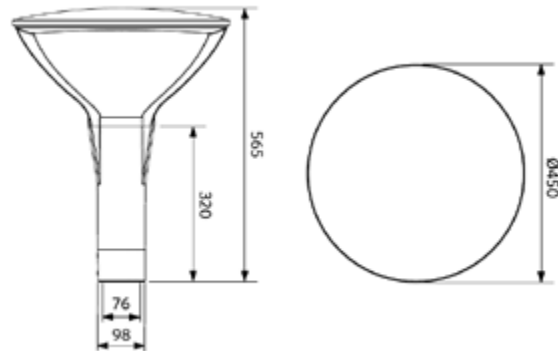



Bollard Performer

- Professional urban landscape luminaire with discreet design
- Special optics to reduce glare to pedestrians
- Available in two heights (0.6m and 0.9m)
- Die casted aluminium body for optimal heat dissipation
- Safe installation thanks to the included anti vandal screws
- Easy to install thanks to its ground plate threaded design
- Suitable for use on coastal applications



Specifications

Item Code	Item Description	Equivalent to (W)	Power (W)	Lumen	Efficacy (lm/W)	CCT (K)	Weight (kg/pc)
On-Off							
543012002500	LEDBollard-P L600-10.5W-3000-W	CFL 1x32W	10.5	900	85	3000	2.95
543012002900	LEDBollard-P L600-10.5W-4000-W	CFL 1x32W	10.5	1000	95	4000	2.95
543012002600	LEDBollard-P L900-10.5W-3000-W	CFL 1x32W	10.5	900	85	3000	3.74
543012003000	LEDBollard-P L900-10.5W-4000-W	CFL 1x32W	10.5	1000	95	4000	3.74

Accessories



703098000100
LEDBollard Concrete-Mounting-Kit



599000004600
LEDStreet-SE-ExtensionCable-6m



5 YEARS WARRANTY



Technical Specifications	
Lifetime (L70)	50,000 h
Lifetime (L80)	35,000 h
On-/Off-cycles	100,000
Colour consistency (SDCM)	4
Dimmability	On-Off
Beam angle	230°
Finishing	Grey RAL 870-3
Colour rendering index (CRI)	≥ 80
Degree of protection (IP)	IP65
Impact strength	IK08
Protection class	I
Risk group (EN 62471)	RG0
With control gear	Yes
Glow wire test	850°C
Driver failure rate (at 5,000 hrs)	<0.5 %
Power factor	≥ 0.9
Surge protection	4 kV

Electrical Supply	
Frequency	50/60 Hz
Nominal voltage	220-240 V AC
DC input voltage	See catalogue appendix Connection Specifications

Mechanical Properties	
Housing material	Aluminium
Optical material	Polycarbonate
Coastal proof	Yes

Ambient Conditions	
Operating temperature	-20-+45°C
Application temperature	+25°C
Storage environment	-40-+60°C

Dimensional Drawing (mm)

LEDBollard-P L600

LEDBollard-P L906

LEDBollard Concrete-Mounting-Kit

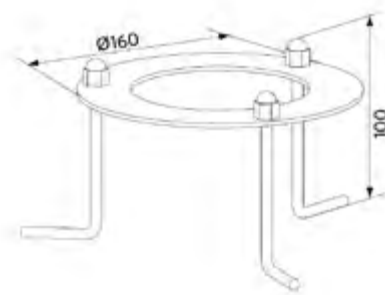
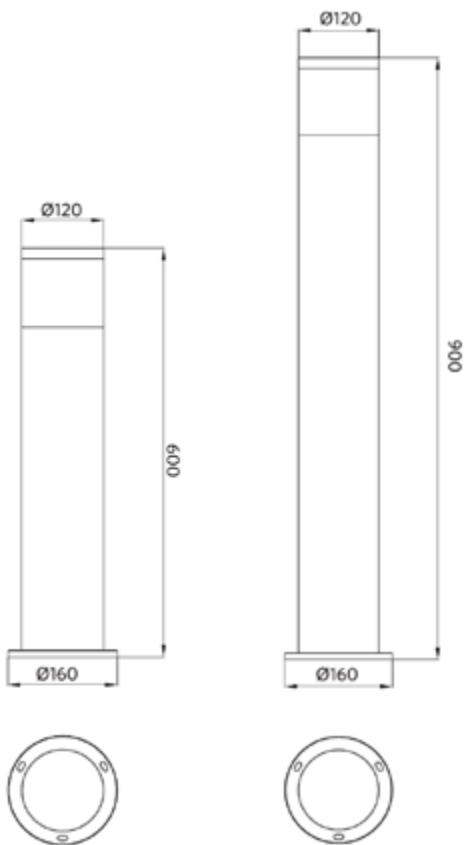



- Architectural urban landscape luminaire for outdoor applications
- Modern LED module design, with downward facing luminous circle
- Available in two heights (0.5m and 1m)
- IP65 and IK10, suitable for use on coastal applications
- Top-cover accessory standard included
- IP68 Waterproof connector included for easy wiring



Specifications

Item Code	Item Description	Equivalent to (W)	Power (W)	Lumen	Efficacy (lm/W)	CCT (K)	Weight (kg/pc)
On-Off							
703000003100	LEDBollard-Luke-E L500-8W-830-BL	Halogen 60W	8	600	75	3000	1.72
703000003200	LEDBollard-Luke-E L500-8W-840-BL	Halogen 60W	8	650	80	4000	1.72
703000003300	LEDBollard-Luke-E L1000-8W-830-BL	Halogen 60W	8	600	75	3000	2.72
703000003400	LEDBollard-Luke-E L1000-8W-840-BL	Halogen 60W	8	650	80	4000	2.72

Accessories

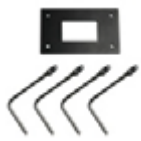

703098000300
LEDBollard-Luke-E Concrete-Mounting-Kit



599000004600
LEDStreet-SE-ExtensionCable-6m



5 YEARS WARRANTY



Technical Specifications

Lifetime (L70)	50,000 h
Lifetime (L80)	30,000 h
On-/Off-cycles	100,000
Colour consistency (SDCM)	4
Dimmability	On-Off
Beam angle	120°
Finishing	Black RAL 9005
Colour rendering index (CRI)	≥ 80
Degree of protection (IP)	IP65
Impact strength	IK10
Protection class	I
Risk group (EN 62471)	RG1
With control gear	Yes
Glow wire test	850°C
Driver failure rate (at 5,000 hrs)	<1 %
Power factor	≥ 0.9
Surge protection	1 kV

Electrical Supply

Frequency	50/60 Hz
Nominal voltage	220-240 V AC
DC input voltage	See catalogue appendix Connection Specifications

Mechanical Properties

Housing material	Aluminium
Optical material	Polycarbonate
Coastal proof	Yes

Ambient Conditions

Operating temperature	-20-+45°C
Application temperature	+25°C
Storage environment	-20-+60°C

Dimensional Drawing (mm)

LEDBollard-Luke-E L500-8W

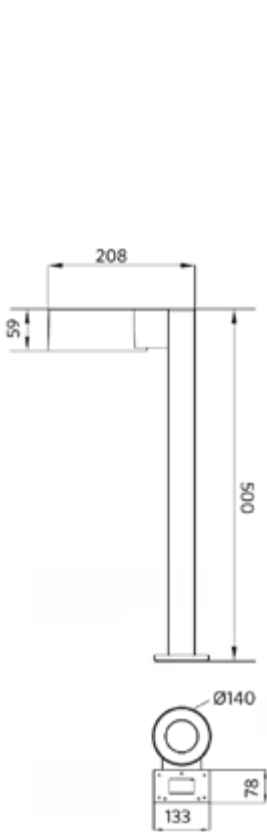

LEDBollard-Luke-E L1000-8W



LEDBollard-Luke-E Concrete-Mounting-Kit

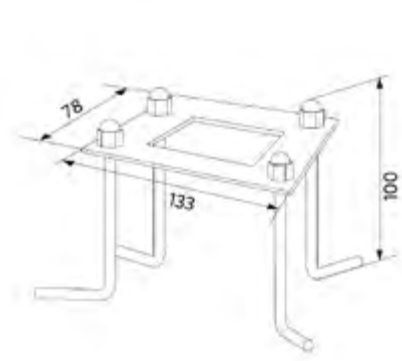



Spot Projector

- Stylish outdoor spot
- Sleek award-winning design
- Suitable for illuminating walls and signages or highlighting objects in parks and gardens
- IP66 water resistance level and IK07 impact protection
- Adjustable tilting angle of 180°
- Die casted aluminium body
- 1.5 meter cable for convenient connection
- Earth spike accessory available



Specifications

Item Code	Item Description	Equivalent to (W)	Power (W)	Lumen	Efficacy (lm/W)	CCT (K)	Beam angle	Weight (kg/pc)
On-Off								
709000027000	LEDSpotProjector-E Rd82-8W-830-36D	Halogen 50W	8	600	75	3000	36°	0.72
709000027200	LEDSpotProjector-E Rd82-8W-840-36D	Halogen 50W	8	600	75	4000	36°	0.72
709000027400	LEDSpotProjector-E Rd127-15W-830-36D	Halogen 75W	15	1200	80	3000	36°	0.95
709000027600	LEDSpotProjector-E Rd127-15W-840-36D	Halogen 75W	15	1200	80	4000	36°	0.95

Accessories



709098000200
LEDProjector-Spike



543098021900
LEDFixture-IP68-Connector-Kit-3



5 YEARS WARRANTY



Technical Specifications	
Lifetime (L70)	50,000 h
Lifetime (L80)	30,000 h
On-/Off-cycles	100,000
Colour consistency (SDCM)	4
Dimmability	On-Off
Finishing	Black
Colour rendering index (CRI)	≥ 80
Degree of protection (IP)	IP66
Impact strength	IK07
Protection class	I
Risk group (EN 62471)	RG1
With control gear	Yes
Glow wire test	850°C
Driver failure rate (at 5,000 hrs)	<1%
Power factor	0.5
Surge protection	2.5 kV

Electrical Supply	
Frequency	50/60 Hz
Nominal voltage	220-240 V AC
DC input voltage	See catalogue appendix Connection Specifications

Mechanical Properties	
Housing material	Aluminium
Optical material	Polycarbonate

Ambient Conditions	
Operating temperature	-30-+50°C
Application temperature	+25°C
Storage environment	-30-+60°C

Dimensional Drawing (mm)

LEDSpotProjector-E Rd82

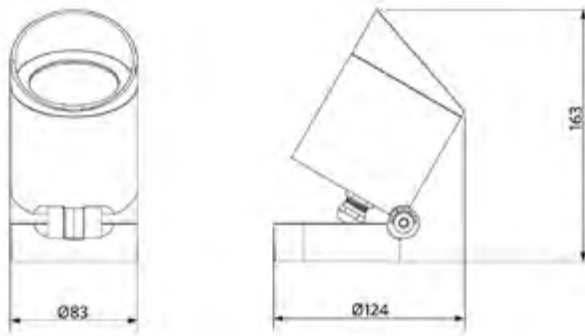

LEDSpotProjector-E Spike

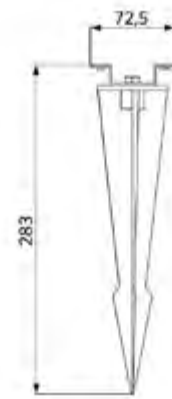

LEDSpotProjector-E Rd127

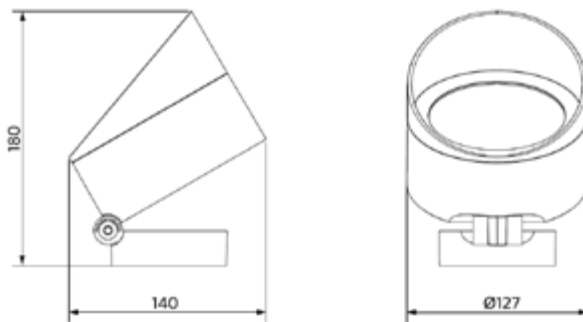



Wall Spot

- Up and down accent lighting suitable for modern architecture
- IP65 water resistance level with strong impact protection of IK06
- Corrosion-resistant die-cast aluminium body with no visible screws (stainless steel)
- Easy loop-in and loop-out installation
- Different beam angles available via reflector accessories
- Broad applications including both commercial and residential areas
- IP65 and suitable for use on coastal applications



Specifications

Item Code	Item Description	Equivalent to (W)	Power (W)	Lumen	Efficacy (lm/W)	CCT (K)	Beam angle	Weight (kg/pc)
On-Off								
715000003100	LEDWallSpot-E Rd60-10W-830-24D-WH	Halogen 75W	10	750	75	3000	24°	0.60
715000002900	LEDWallSpot-E Rd60-10W-840-24D-WH	Halogen 75W	10	800	80	4000	24°	0.60
715000002800	LEDWallSpot-E Rd60-10W-830-24D-BL	Halogen 75W	10	750	75	3000	24°	0.60
715000002600	LEDWallSpot-E Rd60-10W-840-24D-BL	Halogen 75W	10	800	80	4000	24°	0.60
715000004000	LEDWallSpot-E Rd76-20W-830-36D-WH	HID 35W	20	2000	100	3000	36°	0.90
715000004100	LEDWallSpot-E Rd76-20W-840-36D-WH	HID 35W	20	2100	105	4000	36°	0.90
715000004200	LEDWallSpot-E Rd76-20W-830-36D-BL	HID 35W	20	2000	100	3000	36°	0.90
715000004300	LEDWallSpot-E Rd76-20W-840-36D-BL	HID 35W	20	2100	105	4000	36°	0.90

Accessories



715000002700
LEDWallSpot-Rd60-Reflector-60D



715000003200
LEDWallSpot-Rd76-Reflector-60D

715000003000
LEDWallSpot-Rd60-Reflector-15D

715000003300
LEDWallSpot-Rd76-Reflector-15D



5 YEARS WARRANTY



Technical Specifications	
Lifetime (L70)	50,000 h
Lifetime (L80)	30,000 h
On-/Off-cycles	100,000
Colour consistency (SDCM)	4
Dimmability	On-Off
Finishing	White / Black
Colour rendering index (CRI)	≥ 80
Degree of protection (IP)	IP65
Impact strength	IK06
Protection class	I
Risk group (EN 62471)	RG1
With control gear	Yes
Glow wire test	650°C
Driver failure rate (at 5,000 hrs)	<1 %
Displacement factor (DF)	≥ 0.9

Electrical Supply	
Frequency	50/60 Hz
Nominal voltage	220-240 V AC
DC input voltage	See catalogue appendix Connection Specifications

Mechanical Properties	
Housing material	Aluminium
Optical material	Polycarbonate
Coastal proof	Yes

Ambient Conditions	
Operating temperature	-30-+45°C
Application temperature	+25°C
Storage environment	-30-+60°C

Dimensional Drawing (mm)

LEDWallSpot-E Rd60

LEDWallSpot-E Rd76

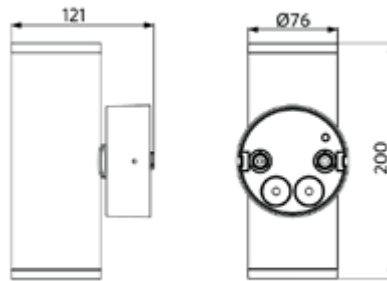
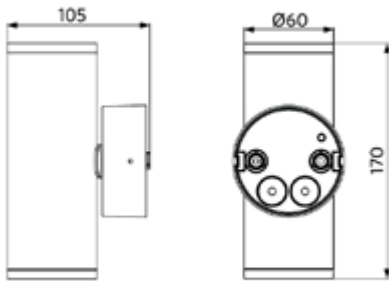



Wall Light Lucia

- Stylish, compact and sturdy wall mounted fixture for outdoor application
- Ultra-slim with only 30mm thickness
- Aesthetic up-down lighting effect
- Elegant die-casted body design without visible screws
- Easy loop-in and loop-out installation
- IP65 and suitable for use on coastal applications



Specifications

Item Code	Item Description	Equivalent to (W)	Power (W)	Lumen	Efficacy (lm/W)	CCT (K)	Weight (kg/pc)
On-Off							
715000006700	LEDWall-Lucia-E Re135-6W-830-WH	Halogen 60W	6	570	95	3000	0.47
715000006500	LEDWall-Lucia-E Re135-6W-840-WH	Halogen 60W	6	600	100	4000	0.47
715000006300	LEDWall-Lucia-E Re135-6W-830-BL	Halogen 60W	6	570	95	3000	0.47
715000006100	LEDWall-Lucia-E Re135-6W-840-BL	Halogen 60W	6	600	100	4000	0.47
715000006800	LEDWall-Lucia-E Re175-10W-830-WH	Halogen 80W	10	950	95	3000	0.57
715000006600	LEDWall-Lucia-E Re175-10W-840-WH	Halogen 80W	10	1000	100	4000	0.57
715000006400	LEDWall-Lucia-E Re175-10W-830-BL	Halogen 80W	10	950	95	3000	0.57
715000006200	LEDWall-Lucia-E Re175-10W-840-BL	Halogen 80W	10	1000	100	4000	0.57

Technical Specifications	
Lifetime (L70)	50,000 h
Lifetime (L80)	30,000 h
On-/Off-cycles	100,000
Colour consistency (SDCM)	4
Dimmability	On-Off
Beam angle	30° x 80°
Finishing	White / Black
Colour rendering index (CRI)	≥ 80
Degree of protection (IP)	IP65
Impact strength	IK08
Protection class	I
Risk group (EN 62471)	RG1
With control gear	Yes
Glow wire test	850°C
Driver failure rate (at 5,000 hrs)	<1 %
Power factor	≥ 0.9

Electrical Supply	
Frequency	50/60 Hz
Nominal voltage	220-240 V AC
DC input voltage	No

Mechanical Properties	
Housing material	Aluminium
Optical material	Polycarbonate
Coastal proof	Yes

Ambient Conditions	
Operating temperature	-20-+45°C
Application temperature	+25°C
Storage environment	-20-+60°C



Dimensional Drawing (mm)

LEDWall-Lucia-E Re135-6W

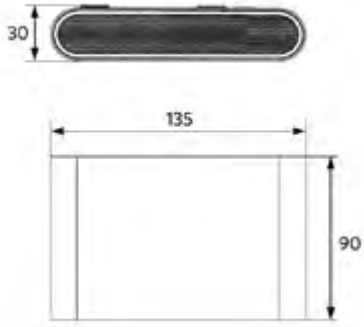

LEDWall-Lucia-E Re175-10W





Flood HO

- Professional luminaire with special optics for area lighting
- Including IP68 connector for easy connection
- Up to 40% energy saving compared to HID solutions
- Different optics to illuminate sport pitches (Class II/III EN 12193:2018) and open areas
- Robust design: full IP66 and IK08 protection
- Equipped with 1-10V or DALI dimming for further energy saving
- Anodized aluminium heatsink, ideal for coastal environments



Specifications

Item Code	Item Description	Equivalent to (W)	Power (W)	Lumen	Efficacy (lm/W)	CCT (K)	Beam angle	Effective wind area	Weight (kg/pc)
1-10V									
543017043300	LEDfloodHO-P-310W-4000-W	HID 500W	310	40000	130	4000	120° x 30°	1110 cm ²	13.47
543017045600	LEDfloodHO-P-310W-4000-N	HID 500W	310	40000	130	4000	60°	1110 cm ²	13.47
543017045400	LEDfloodHO-P-310W-4000-XN	HID 500W	310	40000	130	4000	25°	1110 cm ²	13.47
543017045000	LEDfloodHO-P-620W-4000-W	HID 1000W	620	80000	130	4000	120° x 30°	2331 cm ²	17.64
543017045100	LEDfloodHO-P-620W-4000-N	HID 1000W	620	80000	130	4000	60°	2331 cm ²	17.64
543017045300	LEDfloodHO-P-620W-4000-XN	HID 1000W	620	80000	130	4000	25°	2331 cm ²	17.64
543017013300	LEDfloodHO-P-310W-5700-W	HID 500W	310	40000	130	5700	120° x 30°	1110 cm ²	13.47
543017013200	LEDfloodHO-P-310W-5700-N	HID 500W	310	40000	130	5700	60°	1110 cm ²	13.47
543017013100	LEDfloodHO-P-310W-5700-XN	HID 500W	310	40000	130	5700	25°	1110 cm ²	13.47
543017012700	LEDfloodHO-P-620W-5700-W	HID 1000W	620	80000	130	5700	120° x 30°	2331 cm ²	17.64
543017012600	LEDfloodHO-P-620W-5700-N	HID 1000W	620	80000	130	5700	60°	2331 cm ²	17.64
543017012500	LEDfloodHO-P-620W-5700-XN	HID 1000W	620	80000	130	5700	25°	2331 cm ²	17.64

By default 1-10V dimmable. Available on request with DALI dimming.

310W version standard including bracket. 620W version standard without bracket. 1240W versions available by combining two 620W modules and the mounting kit-4mod accessory.

For more technical information, please go to the appendix.

Accessories



543098006000
LEDfloodHO-P-MountingKit-2Mod



543098005800
LEDfloodHO-P-MountingKit-4Mod



543098005900
LEDfloodHO-P-SafetyCable



5 YEARS WARRANTY



Technical Specifications	
Lifetime (L70)	100,000 h
Lifetime (L80)	70,000 h
On-/Off-cycles	100,000
Colour consistency (SDCM)	6
Dimmability	1-10V
Finishing	Black
Colour rendering index (CRI)	≥ 70
Degree of protection (IP)	IP66
Impact strength	IK08
Protection class	I
Risk group (EN 62471)	RG0
With control gear	Yes
Glow wire test	850°C
Driver failure rate (at 5,000 hrs)	<0.5 %
Power factor	≥ 0.9
Surge protection	6 kV

Electrical Supply	
Frequency	50/60 Hz
Nominal voltage	220-240 V AC
DC input voltage	See catalogue appendix Connection Specifications
230V Cable length	1 m

Mechanical Properties	
Housing material	Aluminium
Optical material	Polycarbonate
Cover material	Polycarbonate
Coastal proof	Yes

Ambient Conditions	
Operating temperature	-30-+50°C
Application temperature	+25°C
Storage environment	-30-+60°C

Dimensional Drawing (mm)

LEDfloodHO-P-310W

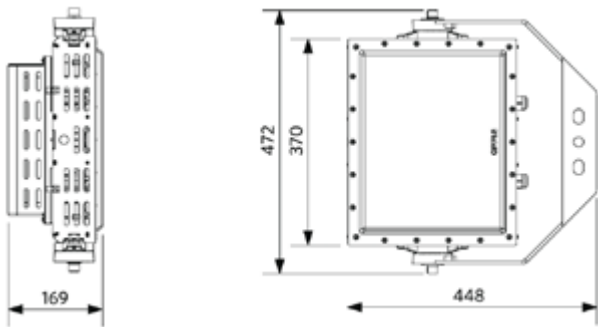

LEDfloodHO-P-620W (+MountingKit-2Mod)

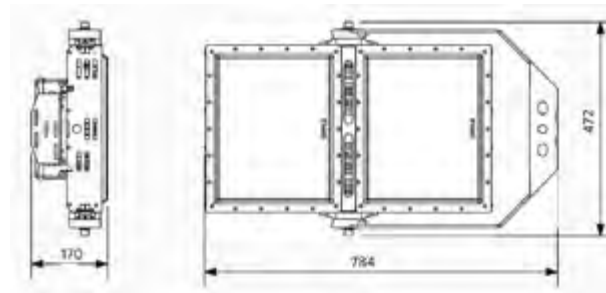

LEDfloodHO-P-620W (x2 +MountingKit-4Mod)

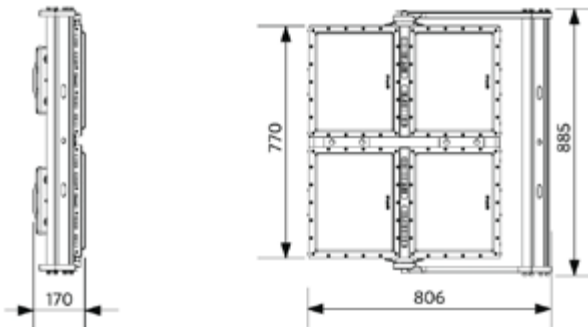



- Precise optical design for area-, object- and façade lighting
- Super slim aluminium body with integrated heatsink and clipless cover
- Very high Efficacy of up to 145 lm/W
- High energy saving up to 65% compared to halogen and high pressure sodium lamps
- Wide (W), Asymmetric (AS) and Narrow (N) beam angles available
- Robust design with high protection against water and dust
- Equipped with a valve to regulate pressure differences
- Available in 32,000 lumen High Power version



Specifications

Item Code	Item Description	Equivalent to (W)	Power (W)	Lumen	Efficacy (lm/W)	CCT (K)	Beam angle	Colour rendering index (CRI)	Surge protection	Weight (kg/pc)
On-Off										
140062030	LEDflood-P Re440-90W-4000-W-BL	HID 250W	90	11250	125	4000	100°	≥ 80	4 kV	6.41
140062031	LEDflood-P Re440-90W-4000-AS-BL	HID 250W	90	11250	125	4000	55° x 115°	≥ 80	4 kV	6.41
140062032	LEDflood-P Re440-125W-4000-W-BL	HID 400W	125	15625	125	4000	100°	≥ 80	4 kV	6.41
140062033	LEDflood-P Re440-125W-4000-AS-BL	HID 400W	125	15625	125	4000	55° x 115°	≥ 80	4 kV	6.41
140062034	LEDflood-P Re440-160W-4000-W-BL	HID 400W	160	20000	125	4000	100°	≥ 80	4 kV	6.41
140062035	LEDflood-P Re440-160W-4000-AS-BL	HID 400W	160	20000	125	4000	55° x 115°	≥ 80	4 kV	6.41
543017041100	LEDflood-P Re440-220W-4000-N-BL	HID 500W	220	32000	145	4000	50°	≥ 70	10 kV	6.41
543017026200	LEDflood-P Re440-220W-4000-AS-BL	HID 500W	220	32000	145	4000	55° x 115°	≥ 70	10 kV	6.41
543017041200	LEDflood-P Re440-220W-5700-N-BL	HID 500W	220	32000	145	5700	50°	≥ 70	10 kV	6.41
543017026400	LEDflood-P Re440-220W-5700-AS-BL	HID 500W	220	32000	145	5700	55° x 115°	≥ 70	10 kV	6.41

Accessories



543098021900
LEDFixture-IP68-Connector-Kit-3



599000004600
LEDStreet-SE-ExtensionCable-6m



5 YEARS WARRANTY



Technical Specifications	
Lifetime (L70)	70,000 h
Lifetime (L80)	50,000 h
On-/Off-cycles	100,000
Colour consistency (SDCM)	4
Dimmability	On-Off
Finishing	Black
Degree of protection (IP)	IP66
Impact strength	IK08
Protection class	I
Risk group (EN 62471)	RG1
With control gear	Yes
Glow wire test	650°C
Driver failure rate (at 5,000 hrs)	<0.5 %
Power factor	≥ 0.9

Electrical Supply	
Frequency	50/60 Hz
Nominal voltage	220-240 V AC
DC input voltage	See catalogue appendix Connection Specifications
230V Cable length	1 m

Mechanical Properties	
Housing material	Die-casted Aluminum
Optical material	Polycarbonate
Cover material	Tempered glass

Ambient Conditions	
Operating temperature	-25-+50°C
Application temperature	+25°C
Storage environment	-30-+60°C

Dimensional Drawing (mm)

LED Flood-P Re440

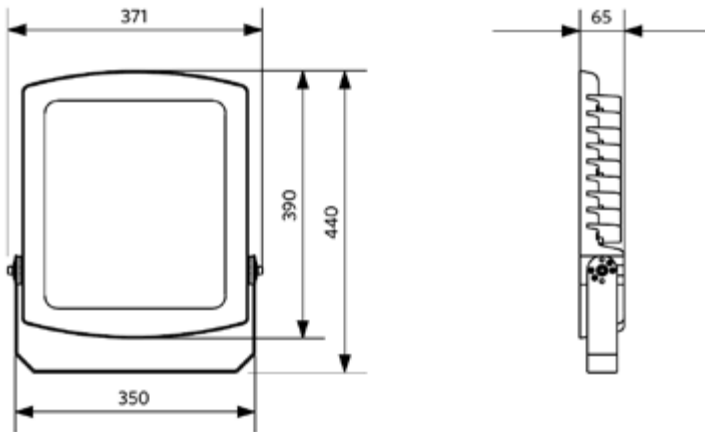



Floodlight Modulo Performer

- Precise modular optical design for area, object and facade lighting
- Super slim aluminium body with integrated heatsink
- Very high efficacy of up to 140 lm/W
- Standard asymmetric (AS) and narrow (N) beam angles available
- Robust design with high protection against water and dust
- Available in wide range from 9,800 up to 42,000 lumen
- High energy saving up to 65% compared to halogen and high pressure sodium lamps
- IP66 and suitable for use on coastal applications



Specifications

Item Code	Item Description	Equivalent to (W)	Power (W)	Lumen	Efficacy (lm/W)	CCT (K)	Beam angle	Surge protection	Weight (kg/pc)
On-Off									
709000056900	LED FloodMo-P Re340-70W-840-AS	HID 150W	70	9800	140	4000	40° x 100°	10 kV	4.40
709000057500	LED FloodMo-P Re340-100W-840-AS	HID 250W	100	14000	140	4000	40° x 100°	10 kV	4.40
709000058100	LED FloodMo-P Re450-150W-840-AS	HID 400W	150	21000	140	4000	40° x 100°	6 kV	5.70
709000058500	LED FloodMo-P Re450-200W-840-N	HID 400W	200	28000	140	4000	45°	6 kV	5.70
709000058700	LED FloodMo-P Re450-200W-840-AS	HID 400W	200	28000	140	4000	40° x 100°	6 kV	5.70
709000058800	LED FloodMo-P Re450-200W-857-N	HID 400W	200	28000	140	5700	45°	6 kV	5.70
709000059000	LED FloodMo-P Re450-200W-857-AS	HID 400W	200	28000	140	5700	40° x 100°	6 kV	5.70
709000059100	LED FloodMo-P Re570-250W-840-N	HID 2x250W	250	35000	140	4000	45°	10 kV	7.67
709000059300	LED FloodMo-P Re570-250W-840-AS	HID 2x250W	250	35000	140	4000	40° x 100°	10 kV	7.67
709000059400	LED FloodMo-P Re570-250W-857-N	HID 2x250W	250	35000	140	5700	45°	10 kV	7.67
709000059600	LED FloodMo-P Re570-250W-857-AS	HID 2x250W	250	35000	140	5700	40° x 100°	10 kV	7.67
709000059700	LED FloodMo-P Re570-300W-840-N	HID 2x400W	300	42000	140	4000	45°	10 kV	7.67
709000059900	LED FloodMo-P Re570-300W-840-AS	HID 2x400W	300	42000	140	4000	40° x 100°	10 kV	7.67
709000060000	LED FloodMo-P Re570-300W-857-N	HID 2x400W	300	42000	140	5700	45°	10 kV	7.67
709000060200	LED FloodMo-P Re570-300W-857-AS	HID 2x400W	300	42000	140	5700	40° x 100°	10 kV	7.67

Accessories



543098021900
LED Fixture-IP68-Connector-Kit-3



599000004600
LED Street-SE-Extension Cable-6m



5 YEARS WARRANTY



Technical Specifications	
Lifetime (L70)	100,000 h
Lifetime (L80)	70,000 h
On-/Off-cycles	100,000
Colour consistency (SDCM)	4
Dimmability	On-Off
Finishing	Grey RAL 870-3
Colour rendering index (CRI)	≥ 80
Degree of protection (IP)	IP66
Impact strength	IK08
Protection class	I
Risk group (EN 62471)	RG1
With control gear	Yes
Glow wire test	850°C
Driver failure rate (at 5,000 hrs)	<1 %
Power factor	≥ 0.9

Electrical Supply	
Frequency	50/60 Hz
Nominal voltage	220-240 V AC
DC input voltage	See catalogue appendix Connection Specifications
230V Cable length	1 m

Mechanical Properties	
Housing material	Die-casted Aluminum
Optical material	Polycarbonate
Cover material	Polycarbonate
Coastal proof	Yes

Ambient Conditions	
Operating temperature	-40-+50°C
Application temperature	+25°C
Storage environment	-40-+50°C

Dimensional Drawing (mm)

LEDfloodMo-P Re340

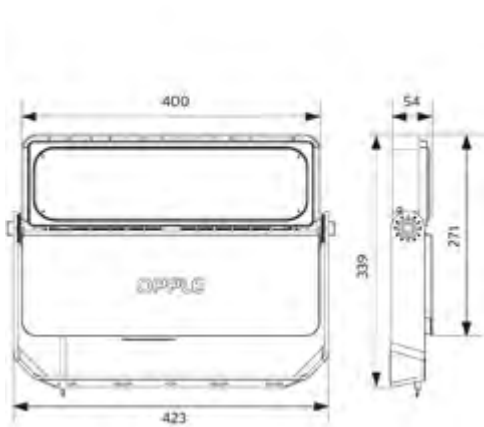

LEDfloodMo-P Re450

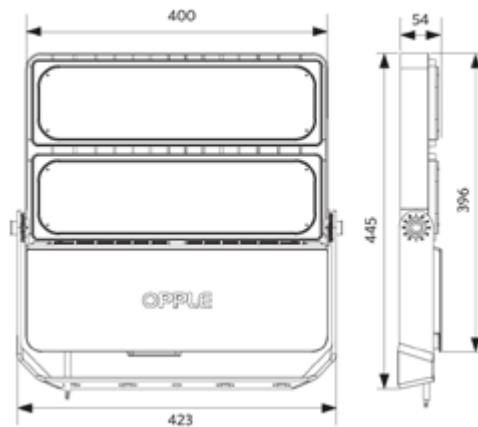

LEDfloodMo-P Re570

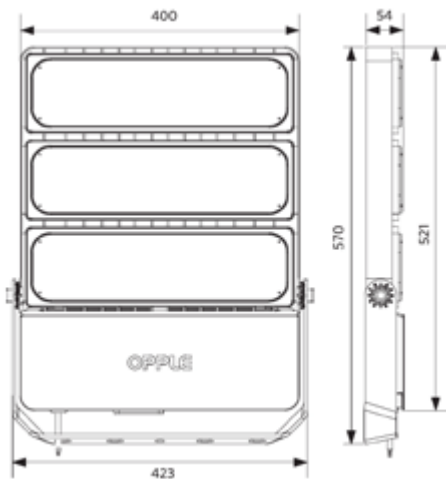



Floodlight EcoMax G2 Medium Power

- Slim aluminium body with integrated heatsink and clipless cover
- Robust and water- and dustproof
- High efficacy up to 120 lm/W
- High energy saving compared to halogen and high pressure sodium lamps
- Range from 3,300 to 8,400 lm
- Available in 3000K and 4000K
- Compatible brackets, ground spikes and other installation accessories available
- IP65 daylight and motion sensor accessory available



Specifications

Item Code	Item Description	Equivalent to (W)	Power (W)	Lumen	Efficacy (lm/W)	CCT (K)	Beam angle	Weight (kg/pc)
On-Off								
543017012100	LED Flood-E2 Re199-30W-3000-BL	HID 50W	30	3300	110	3000	110°	0.97
543017011800	LED Flood-E2 Re199-30W-4000-BL	HID 50W	30	3600	120	4000	110°	0.97
543017012000	LED Flood-E2 Re253-50W-3000-BL	HID 70W	50	5500	110	3000	110°	1.42
543017011700	LED Flood-E2 Re253-50W-4000-BL	HID 70W	50	6000	120	4000	110°	1.42
543017011600	LED Flood-E2 Re283-70W-4000-BL	HID 150W	70	8400	120	4000	110°	2.09

Accessories



543098021900
LED Fixture-IP68-Connector-Kit-3



140065060
LED Flood-E-Motion-Daylight-Sensor



599000004600
LED Street-SE-Extension Cable-6m



5 YEARS WARRANTY



Technical Specifications	
Lifetime (L70)	50,000 h
Lifetime (L80)	30,000 h
On-/Off-cycles	100,000
Colour consistency (SDCM)	4
Dimmability	On-Off
Finishing	Black
Colour rendering index (CRI)	≥ 80
Degree of protection (IP)	IP65
Impact strength	IK07
Protection class	I
Risk group (EN 62471)	RG1
With control gear	Yes
Glow wire test	650°C
Driver failure rate (at 5,000 hrs)	<0,5 %
Power factor	≥ 0.9
Surge protection	2 kV

Electrical Supply	
Frequency	50/60 Hz
Nominal voltage	220-240 V AC
DC input voltage	See catalogue appendix Connection Specifications
230V Cable length	1 m

Mechanical Properties	
Housing material	Aluminium
Optical material	Polycarbonate
Cover material	Tempered glass

Ambient Conditions	
Operating temperature	-30-+50°C
Application temperature	+25°C
Storage environment	-30-+60°C

Dimensional Drawing (mm)

LEDflood-E2 Re199

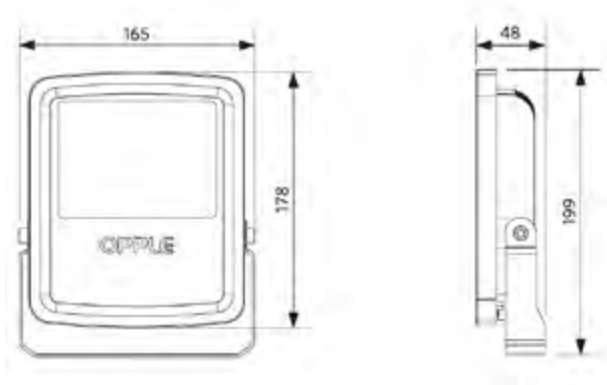

LEDflood-E2 Re253

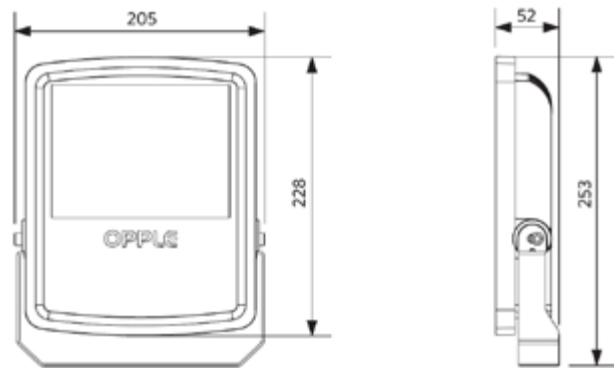

LEDflood-E2 Re283

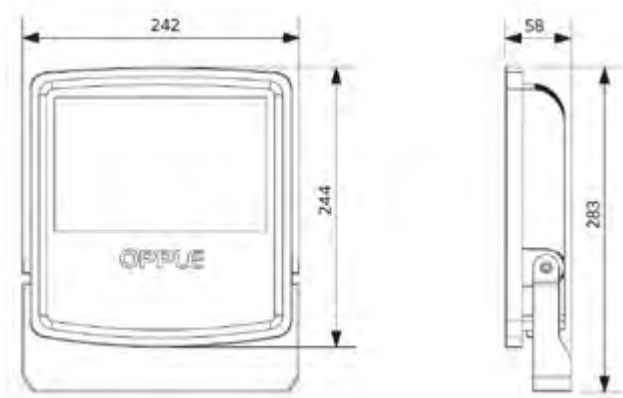

LEDflood-E Sensor

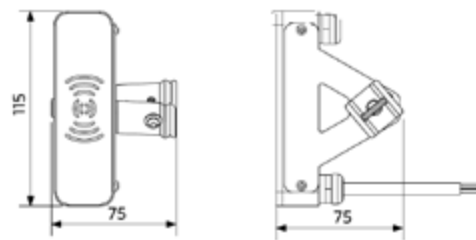



Floodlight EcoMax G2 Low Power

- Compact aluminium design with clipless cover
- IP66 protection level against water and dust
- High energy saving compared to halogen and high pressure sodium lamps
- Available in white (WH) and black (BL) versions
- Available in 3000K and 4000K
- Compatible brackets and ground spikes available
- IP65 daylight and motion sensor accessory available



Specifications

Item Code	Item Description	Equivalent to (W)	Power (W)	Lumen	Efficacy (lm/W)	CCT (K)	Beam angle	Weight (kg/pc)
On-Off								
543017020400	LEDflood-E2 Re113-10W-3000-BL	Halogen 50W	10	1050	105	3000	100°	0.25
543006000600	LEDflood-E2 Re113-10W-4000-BL	Halogen 50W	10	1050	105	4000	100°	0.25
543006000700	LEDflood-E2 Re127-19W-3000-BL	Halogen 100W	19	1900	100	3000	100°	0.30
543006000800	LEDflood-E2 Re127-19W-4000-BL	Halogen 100W	19	1900	100	4000	100°	0.30
543017020500	LEDflood-E2 Re113-10W-3000-WH	Halogen 50W	10	1050	105	3000	100°	0.25
543006000900	LEDflood-E2 Re113-10W-4000-WH	Halogen 50W	10	1050	105	4000	100°	0.25
543006001000	LEDflood-E2 Re127-19W-3000-WH	Halogen 100W	19	1900	100	3000	100°	0.30
543006001100	LEDflood-E2 Re127-19W-4000-WH	Halogen 100W	19	1900	100	4000	100°	0.30

Accessories



543098021900
LEDFixture-IP68-Connector-Kit-3



140065060
LEDflood-E-Motion-Daylight-Sensor



599000004600
LEDStreet-SE-ExtensionCable-6m



5 YEARS WARRANTY



Technical Specifications	
Lifetime (L70)	50,000 h
Lifetime (L80)	30,000 h
On-/Off-cycles	100,000
Colour consistency (SDCM)	4
Dimmability	On-Off
Finishing	White / Black
Colour rendering index (CRI)	≥ 80
Degree of protection (IP)	IP66
Impact strength	IK07
Protection class	I
Risk group (EN 62471)	RG1
With control gear	Yes
Glow wire test	850°C
Driver failure rate (at 5,000 hrs)	<0,5 %
Power factor	≥ 0.9
Surge protection	2.5 kV

Electrical Supply	
Frequency	50/60 Hz
Nominal voltage	220-240 V AC
DC input voltage	See catalogue appendix Connection Specifications
230V Cable length	1 m

Mechanical Properties	
Housing material	Die-casted Aluminum
Optical material	Polycarbonate
Cover material	Polycarbonate

Ambient Conditions	
Operating temperature	-30-+50°C
Application temperature	+25°C
Storage environment	-30-+60°C

Dimensional Drawing (mm)

LEDflood-E2 Re113

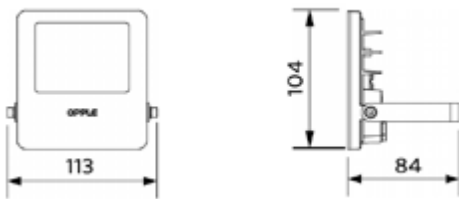

LEDflood-E2 Re127

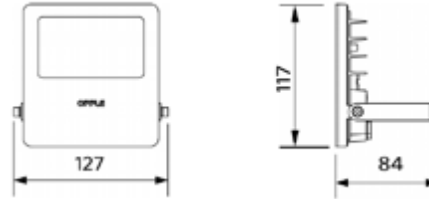

LEDflood-E Sensor

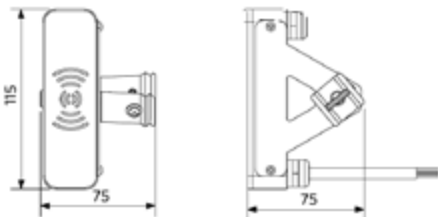





Smart	12
Indoor	30
Outdoor	120
Lamps & Tools	150
Technical Data	164
Glossary	182





- Classic light bulb shape ensures an easy replacement
- Instant 100% light when switched on and no startup time
- No UV / IR radiance so there is less risk of damage
- Up to 86% less energy consumption than traditional bulbs



Specifications

Item Code	Item Description	Equivalent to (W)	Power (W)	Lumen	Efficacy (lm/W)	CCT (K)	Weight (kg/pc)
A60, On-Off							
500010001400	LED-E-A60-FILA-E27-4W-2700K-CL	GLS 40W	4	470	118	2700	0.03
500010001500	LED-E-A60-FILA-E27-7W-2700K-CL	GLS 60W	7	806	115	2700	0.03
A60, Dimmable (Triac)							
500010001100	LED-E-A60-FILA-E27-4.5W-DIM-2700K-CL	GLS 40W	4.5	470	104	2700	0.03
500010001900	LED-E-A60-FILA-E27-4.5W-DIM-2700K-FR	GLS 40W	4.5	470	104	2700	0.03
500010001300	LED-E-A60-FILA-E27-4.5W-DIM-4000K-FR	GLS 40W	4.5	470	104	4000	0.03
500010001000	LED-E-A60-FILA-E27-7W-DIM-2700K-CL	GLS 60W	7	806	115	2700	0.03
500010001200	LED-E-A60-FILA-E27-7W-DIM-2700K-FR	GLS 60W	7	806	115	2700	0.04
500010000400	LED-E-A60-FILA-E27-7W-DIM-4000K-FR	GLS 60W	7	806	115	4000	0.04
B35, On-Off							
500011000500	LED-E-B35-FILA-E14-2.8W-2700K-CL	GLS 25W	2.8	250	89	2700	0.01
500011000300	LED-E-B35-FILA-E14-4W-2700K-CL	GLS 40W	4	470	118	2700	0.01
B35, Dimmable (Triac)							
500011000400	LED-E-B35-FILA-E14-2.8W-DIM-2700K-FR	GLS 25W	2.8	250	89	2700	0.01
500011000200	LED-E-B35-FILA-E14-4.5W-DIM-2700K-CL	GLS 40W	4.5	470	104	2700	0.01
500011000100	LED-E-B35-FILA-E14-4.5W-DIM-2700K-FR	GLS 40W	4.5	470	104	2700	0.02
Mini Globe (P, G45), On-Off							
500010000600	LED-E-P45-FILA-E14-2.8W-2700K-CL	GLS 25W	2.8	250	89	2700	0.01
500010001800	LED-E-P45-FILA-E14-4W-2700K-CL	GLS 40W	4	470	118	2700	0.01
500010002000	LED-E-G45-FILA-E27-2.8W-2700K-CL	GLS 25W	2.8	250	89	2700	0.02
Mini Globe (P, G45), Dimmable (Triac)							
500010000500	LED-E-P45-FILA-E14-2.8W-DIM-2700K-FR	GLS 25W	2.8	250	89	2700	0.02
500010000800	LED-E-G45-FILA-E27-2.8W-DIM-2700K-FR	GLS 25W	2.8	250	89	2700	0.02
500010001700	LED-E-P45-FILA-E14-4.5W-DIM-2700K-CL	GLS 40W	4.5	470	104	2700	0.02
500010000700	LED-E-P45-FILA-E14-4.5W-DIM-2700K-FR	GLS 40W	4.5	470	104	2700	0.02
500010000900	LED-E-G45-FILA-E27-4.5W-DIM-2700K-CL	GLS 40W	4.5	470	104	2700	0.02
500010001600	LED-E-G45-FILA-E27-4.5W-DIM-2700K-FR	GLS 40W	4.5	470	104	2700	0.02
ST64, Dimmable (Triac)							
500012000200	LED-E-ST64-FILA-E27-4.5W-DIM-2200K-CL	GLS 40W	4.5	400	89	2200	0.05
500012000300	LED-E-ST64-FILA-E27-4.5W-DIM-2700K-CL	GLS 40W	4.5	470	104	2700	0.05
500012000400	LED-E-ST64-FILA-E27-7W-DIM-2200K-CL	GLS 60W	7	700	100	2200	0.05
500012000100	LED-E-ST64-FILA-E27-7W-DIM-2700K-CL	GLS 60W	7	806	115	2700	0.05



3 YEARS WARRANTY



Technical Specifications	
Lifetime (L70)	15,000 h
On-/Off-cycles	100,000
Dimmability	On-Off / Triac
Beam angle	360°
Finishing	Clear / Frosted
Colour rendering index (CRI)	≥ 80

Electrical Supply	
Frequency	50/60 Hz
Nominal voltage	220-240 V AC
DC input voltage	No

Ambient Conditions	
Operating temperature	-20-+40°C
Application temperature	+25°C
Storage environment	-25-+50°C

Dimensional Drawing (mm)

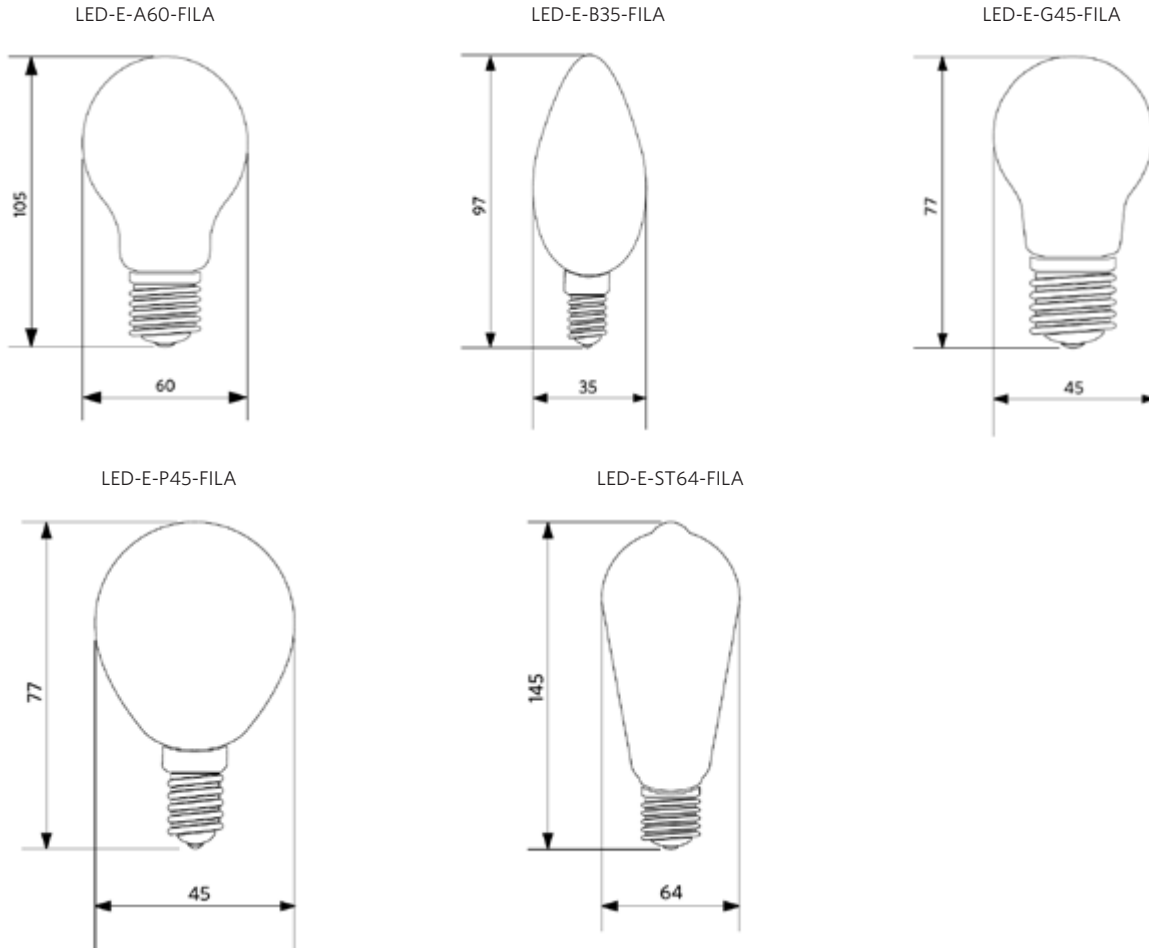

SMART

INDOOR

OUTDOOR

LAMPS & TOOLS

TECHNICAL DATA

GLOSSARY





Reflector EcoMax GU10

- Full retrofit of existing halogen GU10 lamps
- Dimmable versions available up to 575lm
- Available in 3000K and 4000K
- Light silver coloured
- No UV/IR radiation
- Significantly lower heat output than halogen, avoiding discolouration and risk of damaging goods
- Up to 87% lower energy consumption than halogen



Specifications

Item Code	Item Description	Equivalent to (W)	Power (W)	Lumen	Efficacy (lm/W)	CCT (K)	Weight (kg/pc)
Dimmable (Triac)							
140060948	LED-E-GU10-3,5W-3000K-36D-DIM	Halogen 35W	3.5	245	70	3000	0.03
140060952	LED-E-GU10-3,5W-4000K-36D-DIM	Halogen 35W	3.5	260	74	4000	0.03
140060949	LED-E-GU10-5,2W-3000K-36D-DIM	Halogen 50W	5.2	350	67	3000	0.04
140060953	LED-E-GU10-5,2W-4000K-36D-DIM	Halogen 50W	5.2	360	69	4000	0.04
140060951	LED-E-GU10-7,5W-3000K-36D-DIM	Halogen 75W	7.5	565	75	3000	0.06
140060955	LED-E-GU10-7,5W-4000K-36D-DIM	Halogen 75W	7.5	575	77	4000	0.06

Technical Specifications	
Lifetime (L70)	15,000 h
On-/Off-cycles	50,000
Dimmability	Triac
Beam angle	36°
Finishing	Silver
Colour rendering index (CRI)	≥ 80

Electrical Supply	
Frequency	50/60 Hz
Nominal voltage	220-240 V AC
DC input voltage	No

Ambient Conditions	
Operating temperature	-20-+40°C
Application temperature	+25°C
Storage environment	-25-+50°C

3 YEARS WARRANTY



Dimensional Drawing (mm)

LED-E-GU10-3,5W

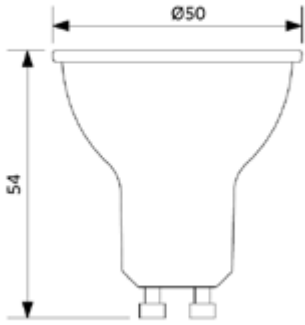

LED-E-GU10-5,2W

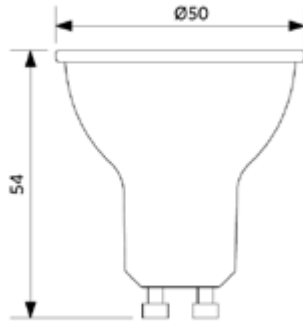

LED-E-GU10-7,5W

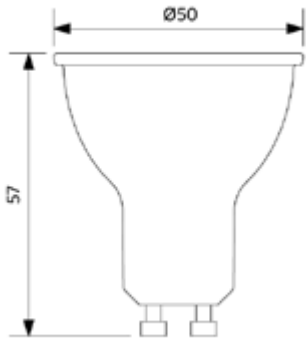



- Single-ended full IEC compliant LED Tube with patented driver
- Retrofit existing T8 lamps with EM ballast installations ONLY!
- No warm-up time, 100% light instantly when switched on
- Full glass body
- High efficacy up to 134 lm/W
- Up to 62% lower energy consumption than fluorescent



SAFE AND EASY INSTALLATION: ONLY USE WITH LED DUMMY STARTER.
Tubes are NOT suitable for serial installation.

Specifications

Item Code	Item Description	Equivalent to (W)	Power (W)	Lumen	Efficacy (lm/W)	CCT (K)	Weight (kg/pc)
On-Off							
140062610	LED P T8 glass 600 8W 100pct 3000K CT	TL 1x18W	8	1050	131	3000	0.11
140062611	LED P T8 glass 600 8W 100pct 4000K CT	TL 1x18W	8	1050	131	4000	0.11
140062612	LED P T8 glass 600 8W 100pct 6500K CT	TL 1x18W	8	1050	131	6500	0.11
140062613	LED P T8 glass 1200 16W 100pct 3000K CT	TL 1x36W	16	2100	131	3000	0.20
140062614	LED P T8 glass 1200 16W 100pct 4000K CT	TL 1x36W	16	2100	131	4000	0.20
140062615	LED P T8 glass 1200 16W 100pct 6500K CT	TL 1x36W	16	2100	131	6500	0.20
140062616	LED P T8 glass 1500 23W 100pct 3000K CT	TL 1x58W	23	3100	134	3000	0.27
140062617	LED P T8 glass 1500 23W 100pct 4000K CT	TL 1x58W	23	3100	134	4000	0.27
140062618	LED P T8 glass 1500 23W 100pct 6500K CT	TL 1x58W	23	3100	134	6500	0.27

Single-ended connection



Technical Specifications		Electrical Supply	
Lifetime (L70)	50,000 h	Frequency	50/60 Hz
On-/Off-cycles	100,000	Nominal voltage	220-240 V AC
Dimmability	On-Off	DC input voltage	No
Beam angle	220°	Ambient Conditions	
Finishing	White	Operating temperature	-25-+45°C
Colour rendering index (CRI)	≥ 80	Application temperature	+25°C
Fitting	G13	Storage environment	-25-+50°C



Dimensional Drawing (mm)

LED P T8 glass 600

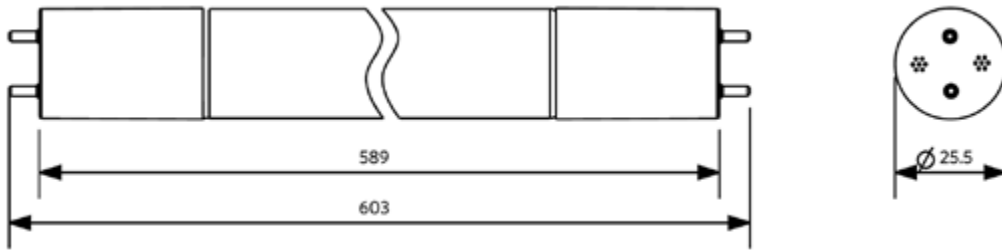

LED P T8 glass 1200

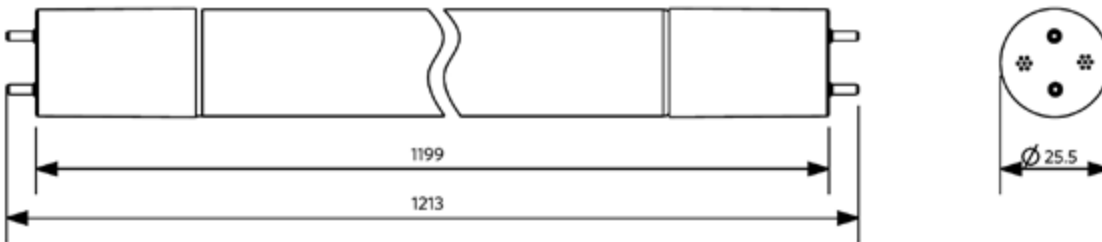

LED P T8 glass 1500

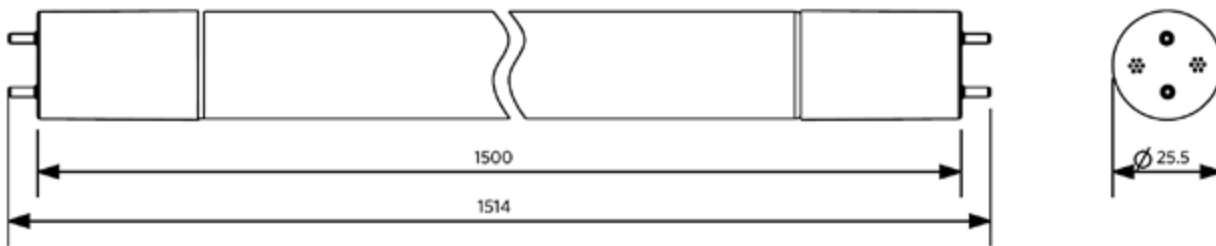



Module Clio G2

- Fits well in slim ceiling luminaires
- Easy and flexible installation
- Shadow free, homogeneous light diffusion
- High efficacy up to 117 lm/W
- Integrated driver
- Including magnets and connection box
- Daylight and motion sensor accessory available



Specifications

Item Code	Item Description	Equivalent to (W)	Power (W)	Lumen	Efficacy (lm/W)	CCT (K)	Weight (kg/pc)
On-Off							
140066573	LED E C module 12W 2700K Clio CT	GLS 75W	12	1300	109	2700	0.10
140066574	LED E C module 12W 4000K Clio CT	GLS 75W	12	1400	117	4000	0.10
140066575	LED E C module 16W 2700K Clio CT II	GLS 100W	16	1650	104	2700	0.17
140066576	LED E C module 16W 4000K Clio CT II	GLS 100W	16	1800	113	4000	0.17
Dimmable (Triac)							
140066204	LED E C module 22W DIM 2700K Clio CT	CFL TC-DD/PL-Q 28W	22	2300	105	2700	0.24
140066205	LED E C module 22W DIM 4000K Clio CT	CFL TC-DD/PL-Q 28W	22	2400	110	4000	0.24
140066206	LED E C module 36W DIM 2700K Clio CT	CFL TC-DD/PL-Q 38W	36	3800	106	2700	0.49
140066207	LED E C module 36W DIM 4000K Clio CT	CFL TC-DD/PL-Q 38W	36	3900	109	4000	0.49

Accessories



140060553
LED Module sensor CT

Sensor only for 12W and 16W.
Sensor range 12m.



3 YEARS WARRANTY



Technical Specifications	
Lifetime (L70)	30,000 h
Lifetime (L80)	20,000 h
On-/Off-cycles	100,000
Dimmability	On-Off / Triac
Beam angle	150°
Colour rendering index (CRI)	≥ 80
Degree of protection (IP)	IP20
Protection class	II
With control gear	Yes

Electrical Supply	
Frequency	50/60 Hz
Nominal voltage	220-240 V AC
DC input voltage	No
230V Cable length	0.3 m

Ambient Conditions	
Operating temperature	-20~+40°C
Application temperature	+25°C
Storage environment	-25~+50°C

Dimensional Drawing (mm)

LED E C module 12W

LED E C module 16W

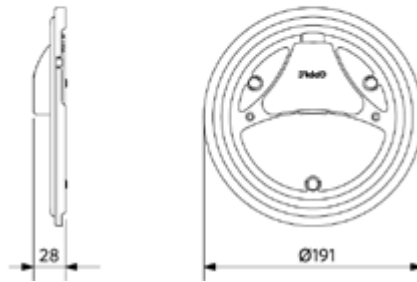
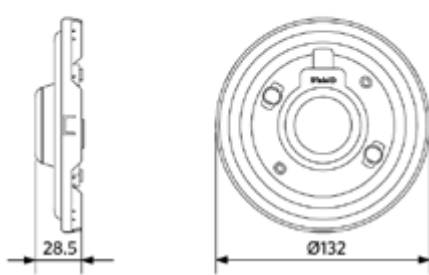

LED E C module 22W

LED E C module 36W

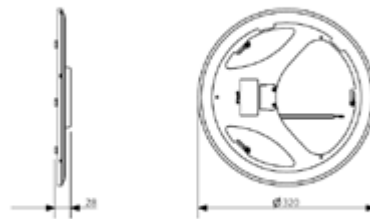
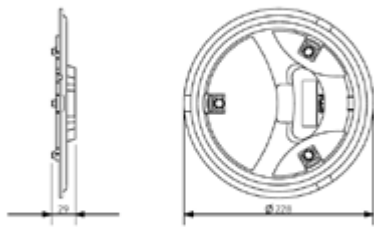

LED Module sensor CT

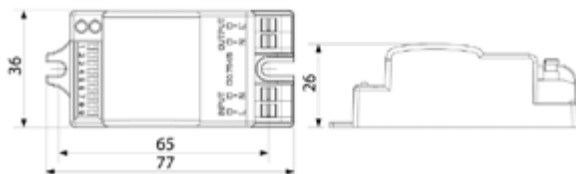

SMART

INDOOR

OUTDOOR

LAMPS & TOOLS

TECHNICAL DATA

GLOSSARY





Light Master G3

- Easy connection via Bluetooth®
- Simple solution for measurement of light level (lux), colour temperature (Kelvin), colour rendering (CRI) and flicker
- Compatible with iOS and Android
- Rechargeable with micro USB (cable not included)
- Stylish protective bag included



Specifications

Item Code	Item Description
599000032700	Light-master-III

Technical Specifications	
Rechargeable	Yes - micro USB
Lux range	0-50000 lx
Color temperature range	2000-25000 K
Accuracy	~ 5% deviation
Operating temperature	-10-+40°C



Dimensional Drawing (mm)

Light-master-III

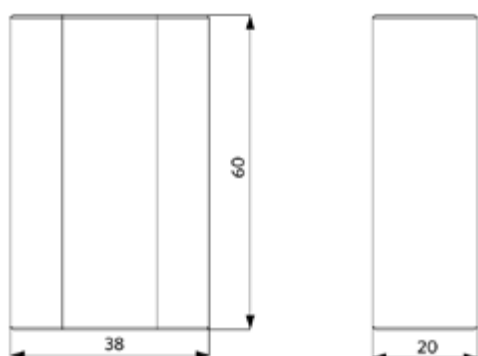

Google Play Store



Apple App Store



Accessories

LED Module sensor CT

- Sensor accessory for luminaires
- Detection range: 12m

Suitable for:

- Ceiling Light Apollo
- Linear Ecomax
- Module Clío G2

L x W x H: 76.7mm x 35.5mm x 25.5mm



Product Code:
140060553

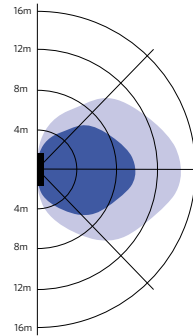

Installation - Wall Mounted
Suggested installation height 1-1.8m

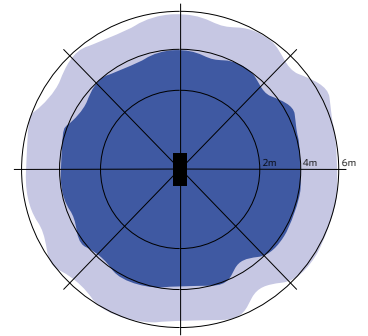

Installation - Ceiling Mounted
Suggested installation height 2.5-6m

LED Waterproof-CLA-Sensor

- Sensor accessory for the LED Waterproof Classic 1.2 and 1.5m
- Detection range: 6m

Suitable for:

- Waterproof Classic

L x W x H: 21mm x 168mm x 28mm



Product Code:
531098000100

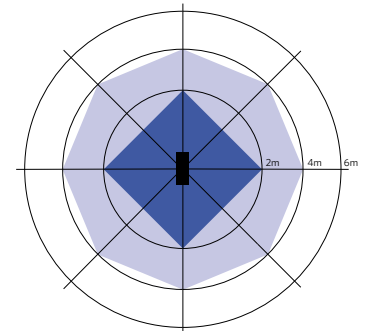

Installation - Ceiling Mounted
Suggested installation height 3-4m

LED Flood-E-Motion-Daylight-Sensor

- Motion and daylight sensor for luminaires
- Detection range: 6m

Suitable for:

- Floodlight Ecomax G2 Medium Power
- Floodlight Ecomax G2 Low Power

L x W x H: 115mm x 37.7mm x 74.8mm



Product Code:
140065060

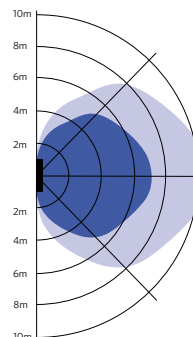

Installation - Wall Mounted
Suggested installation height 2.5-6m

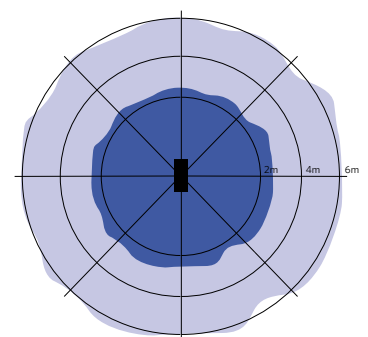

Installation - Ceiling Mounted
Suggested installation height 2.5-6m



Junction-Box-WH

- Stylish connection box for easy wiring of luminaires
- Completely screwless installation
- Included strain relief on the input and output side

Suitable for:

- All recessed panels
- All recessed downlights
- All recessed spots

L x W x H: 103.4mm x 43mm x 26mm



Product Code:
542098030700

LEDPanelRC-SI U19 EM-kit 1h/3h

- Emergency kit for selected OPPLE panel luminaires
- Including battery (1h or 3h version)
- Plug and play installation

Suitable for:

- Panel Monza
- Panel Sydney
- Slim Panel Performer UGR19 G5
- Slim Panel EcoMax UGR22 G2
- Slim Panel EcoMax G4
- Slim Panel Basic G3

L x W x H: 240mm x 34mm x 60mm



Product Code:
542098000800 (1h)
542098000900 (3h)

LEDDownlightRc-P EM-kit 1h/3h

- Emergency kit for selected OPPLE downlight luminaires
- Including battery (1h or 3h version)
- Plug and play installation

Suitable for:

- Downlight Performer HG
- Downlight Performer MW

L x W x H: 240mm x 34mm x 60mm



Product Code:
549098001300 (1h)
549098001400 (3h)

LEDTrunking DALI Power Supply

- DALI Power supply
- Output: 17VDC, 150mA

Suitable for:

- Powering a DALI network up to 64 DALI devices

L x W x H: 191mm x 49mm x 34mm



Product Code:
542098001000







Smart 12
Indoor 30
Outdoor 120
Lamps & Tools 150
Technical Data 164
Glossary 182



Cut-Out Conversion List

Cut-out overview													
Cut-Out (mm)		Ø68	Ø72	Ø76	Ø80	Ø100	Ø120	Ø125	Ø150	Ø172	Ø175	Ø200	
Downlights	Downlight Performer HG	11.5W											
		15W											
		23W											
		33W											
	Downlight Performer MW	11.5W											
		15W											
		23W											
		33W											
		44W											
	Downlight Compact	9W											
		14W											
		18W											
		24W											
	Downlight Slim EcoMax	12W											
		24W											
		24W Sq											
Cut-Out (mm)		Ø68	Ø72	Ø76	Ø80	Ø100	Ø120	Ø125	Ø150	Ø172	Ø175	Ø200	
Spots	Spot Performer Swing	20W											
		35W											
	Spot Round Adjustable HQ	8W											
	Spot Ava G2	5W											
		7W											
	Spot Chiara	6W											
		8W											

Note: for Downlight Performer HG, Downlight Performer MW, Downlight Compact, Downlight Slim EcoMax and Spot Performer Swing, adapter rings are also available.



Adapter Rings Overview

Item code	Item Description	Luminaire cut-out	Existing ceiling hole	Adapter ring outer diameter
140060646	LEDDownlightRc-P-Adapter-150-175	150	175	200
140060647	LEDDownlightRc-P-SI-E-Adapter-200-225	200	225	250
140060648	LEDDownlightRc-P-SI-E-Adapter-200-250	200	250	275
140060650	LEDDownlightRc-Hzdim-Adapter-125-150	125	150	175
140060651	LEDDownlightRc-HZdim-Adapter-175-200	175	200	225
140060652	LEDDownlightRc-Hzdim-Adapter-200-225	200	225	250
140060649	LEDDownlightRc-Hzdim-Adapter-200-250	200	250	275
140060653	LEDDownlightRc-SI-E-Adapter-150-175	150	175	200

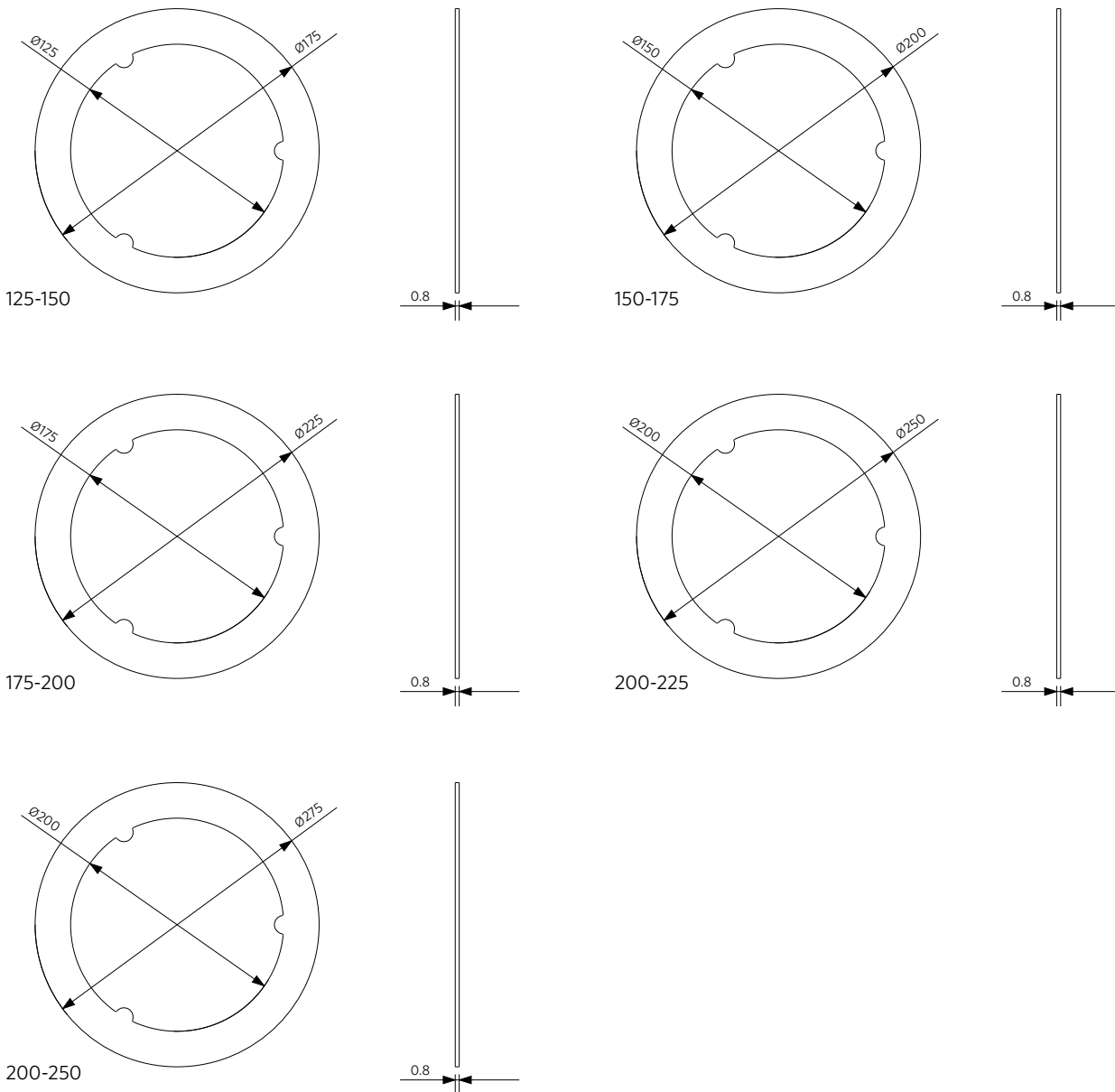

Connection Specifications

Tables below present the maximum number of luminaires that can be connected on one B16/C16 circuit breaker.

Category	Types	DC Input Voltage	Max. units per B16	Max. units per C16	Max. inrush current (A)	Inrush time (µs)
Panel Grille	36W	190-210	37	62	35	270
Panel Grille	33W DALI/BLE Sq595	180-280	11	19	42	240
Panel Grille	33W DALI/BLE Sq298	180-280	11	19	42	240
Panel Monza	35W	n/a	40	57	23	24
Panel Monza	35W DALI/10V/BLE	180-280	21	35	21	162
Panel Sydney	35W	n/a	40	57	23	24
Panel Sydney	35W DALI/10V/BLE	180-280	21	35	21	162
Slim Panel Performer UGR19 G5	30W/30W DALI	180-280	16	25	25	500
Slim Panel Performer UGR19 G5	34W/34W DALI	180-280	16	25	25	500
Slim Panel Performer UGR19 G5	30W/34W BLE	180-280	16	25	25	500
Slim Panel Performer UGR19 G5	34W BLE TW	180-280	21	35	45	143
Slim Panel EcoMax G4	32W	180-280	6	15	40	316
Slim Panel EcoMax UGR22 G2	34W	n/a	11	19	32	350
Slim Panel Basic G3	32W	180-280	6	15	40	316
Lima	15/18W DALI	180-260	17	28	25	330
Lima	30/36W DALI	180-260	15	26	20	400
Panel Suspended Zenith	75W DALI	190-210	18	30	35	500
Panel Suspended Zenith	75W BLE	200-300	32	35	39	103
Downlight Performer HG	11,5W/11,5W DALI	200-300	55	92	20	356
Downlight Performer HG	15W/15W DALI	200-300	55	92	20	356
Downlight Performer HG	23W/23W DALI	200-300	26	43	18	800
Downlight Performer HG	33W/33W DALI	200-300	26	43	18	800
Downlight Performer HG	11,5W/15W BLE	n/a	55	92	24	100
Downlight Performer HG	23W/23W BLE	n/a	26	43	20	240
Downlight Performer HG	25W BLE TW	n/a	21	35	45	143
Downlight Performer MW	44W	190-210	16	32	25	250
Downlight Performer MW	11,5W/11,5W DALI	200-300	55	92	20	356
Downlight Performer MW	15W/15W DALI	200-300	55	92	20	356
Downlight Performer MW	23W/23W DALI	200-300	26	43	18	800
Downlight Performer MW	33W/33W DALI	200-300	26	43	18	800
Downlight Performer MW	11,5W/15W BLE	n/a	55	92	24	100
Downlight Performer MW	23W/23W BLE	n/a	26	43	20	240
Downlight Performer MW	25W BLE TW	n/a	21	35	45	143
Downlight Compact	9W	n/a	32	53	7	160
Downlight Compact	14W	n/a	30	50	12	80
Downlight Compact	18W	n/a	28	47	12	88
Downlight Compact	24W	n/a	26	43	11	82
Downlight Slim EcoMax	12W	n/a	105	178	11	59
Downlight Slim EcoMax	24W	n/a	52	88	11	56
Spot Performer 3C Compact	12W	180-260	130	130	2	27,2
Spot Performer 3C Compact	25W	310-340	85	85	7,8	79,7
Spot Performer 3C Compact	35W	310-340	55	55	10	78,1
Spot Performer 3C Compact	37W BLE	n/a	21	35	41	150
Spot Performer 3C	30W	200-300	13	22	45	500
Spot EcoMax 3C	30W	200-300	24	40	10	230



Category	Types	DC Input Voltage	Max. units per B16	Max. units per C16	Max. inrush current (A)	Inrush time (µs)
Spot Performer Swing	20W	n/a	101	101	22	40
Spot Performer Swing	35W	n/a	57	57	24	23,5
Spot Performer Swing	35W DALI/BLE	180-280	24	40	41	150
Spot Performer Swing	35W 10V	200-300	24	40	41	150
Spot Round Adjustable HQ	8W	190-210	n/a	n/a	1	500
Spot Ava G2	5W	n/a	441	441	2,6	175
Spot Ava G2	7W	n/a	314	314	2,6	175
Spot Chiara	6W	220-240	103	228	8	216
Spot Chiara	8W	220-240	113	172	12	132
Wall-Mounted Performer	15W/16W	200-300	122	122	25,2	4,8
Wall-Mounted Performer	21W/22W	200-300	90	90	25,2	4,8
Wall-Mounted EcoMax G2	14W	n/a	64	106	74	25
Wall-Mounted EcoMax G2	22W	n/a	84	84	28	25
Ceiling Light Luna	9W	n/a	32	53	7	160
Ceiling Light Luna	14W	n/a	30	50	12	80
Ceiling Light Luna	18W	n/a	28	47	12	88
Ceiling Light Luna	24W	n/a	26	43	12	88
Porchlight EcoMax	5W/6W	200-300	200	350	18	20
Linear EcoMax	20W	n/a	41	70	30	500
Linear EcoMax	40W/54W	n/a	26	44	180	2
T8 Tube	38W	150-300	44	74	17,2	660
Highbay Performer G4	80W (DALI/Static)	190-210	11	18	52	250
Highbay Performer G4	80W (BLE)	180-260	24	40	52	810
Highbay Performer G4	80W (MD)	180-260	9	16	40	300
Highbay Performer G4	115W (DALI/Static)	190-210	11	18	52	250
Highbay Performer G4	115W (BLE)	180-260	24	40	52	810
Highbay Performer G4	115W (MD)	180-260	9	16	40	300
Highbay Performer G4	155W (DALI/Static)	190-210	5	9	35	650
Highbay Performer G4	155W (BLE)	180-260	24	40	52	810
Highbay Performer G4	155W (MD)	180-260	2	4	51	810
Highbay Performer G4	230W (DALI/Static)	190-210	5	9	35	650
Highbay Performer G4	230W (BLE)	180-260	24	40	52	810
Highbay EcoMax G2	80W/120W	n/a	6	11	43	400
Highbay EcoMax G2	150W/200W	n/a	6	10	52	400
Highbay EcoMax G2	240W	n/a	2	3	50	1000
Waterproof Special	24W/34W/45W/54W	175-275	24	40	20	100
Waterproof Performer G3	12,5W	150-300	206	206	10,2	50
Waterproof Performer G3	24W	150-300	64	106	18,4	100
Waterproof Performer G3	38W	150-300	56	56	18,4	100
Waterproof Performer G3	31W	150-300	56	84	20,8	100
Waterproof Performer G3	47W	150-300	44	44	19,8	100
Waterproof Performer G3	54W	150-300	39	39	26,8	100
Waterproof Performer G3	12,5W (DALI/BLE)	150-300	24	40	41	240
Waterproof Performer G3	24W (DALI/BLE)	150-300	24	40	41	240
Waterproof Performer G3	38W (DALI/BLE)	150-300	24	40	41	240
Waterproof Performer G3	31W (DALI/BLE)	150-300	24	40	41	240
Waterproof Performer G3	47W (DALI/BLE)	150-300	24	40	41	240
Waterproof Performer G3	54W (DALI/BLE)	150-300	24	40	41	240
Waterproof Performer G3	75W/90W	180-260	6	11	52	300
Waterproof Classic	20W	240-360	56	90	13	92
Waterproof Classic	29W	240-360	26	50	19	103
Waterproof Classic	43W	240-360	21	34	19	103
Waterproof Classic	53W	240-360	20	34	19	103
Waterproof EcoMax G2	10W	n/a	24	40	8	60
Waterproof EcoMax G2	20W	n/a	24	40	8	80
Waterproof EcoMax G2	18W	n/a	24	40	8	80



Category	Types	DC Input Voltage	Max. units per B16	Max. units per C16	Max. inrush current (A)	Inrush time (µs)
Waterproof EcoMax G2	37W	n/a	24	40	10	80
Waterproof EcoMax G2	27W	n/a	24	40	10	100
Waterproof EcoMax G2	50W	n/a	24	40	13	50
Waterproof Basic	36W	n/a	46	67	12,3	240
Waterproof Basic	50W	n/a	42	42	8,7	150
Trunking	35W	180-260	38	63	15	250
Trunking	35W DALI	180-260	38	63	15	180
Trunking	50W	180-260	18	30	40	178
Trunking	50W DALI	180-260	14	23	40	178
Trunking	70W	180-260	12	20	40	178
Trunking	70W DALI	180-260	14	23	40	178
Roadlight Stratus	60W	171-275	6	16	70	200
Roadlight Stratus	80W	171-275	6	16	70	200
Roadlight Stratus	120W	171-275	6	16	70	200
Roadlight Stratus	150W	171-275	4	11	100	200
Roadlight Stratus	60W DALI	280-370	9	22	98	100
Roadlight Stratus	80W DALI	280-370	9	22	98	100
Roadlight Stratus	120W DALI	280-370	8	16	65	160
Roadlight Stratus	150W DALI	280-370	6	12	68	200
Roadlight Stratus	60W Zhaga	n/a	9	22	98	100
Roadlight Stratus	80W Zhaga	n/a	9	22	98	100
Roadlight Stratus	120W Zhaga	n/a	8	16	65	160
Roadlight Stratus	150W Zhaga	n/a	6	12	68	200
Roadlight EcoMax	80W/100W	200-300	8	20	410	252
Roadlight EcoMax	90W (DALI/STEP)	190-210	7	12	19	1740
Roadlight EcoMax	120W (DALI/STEP)	190-210	5	9	41	510
Roadlight EcoMax	150W (DALI/STEP)	190-210	4	8	49	500
Roadlight EcoMax	200W (DALI/STEP)	190-210	3	6	50	600
Streetlight G2	20W/40W	200-300	29	49	17	250
Streetlight G2	65W	190-210	11	18	14,1	400
Post Top	33W	200-300	16	26	50	134
Post Top	50W	200-300	15	25	50	134
Post Top	68W	200-300	14	23	150	70
Post Top	33W DALI	200-300	16	26	50	134
Post Top	50W DALI	200-300	15	25	50	134
Bollard Performer	10,5W	180-260	75	96	10	25
Bollard Luke	8W	200-300	213	160	6,8	36,6
Spot Projector	10W	220-240	178	178	7	67
Spot Projector	20W	220-240	97	97	7	31
Wall Spot	8W	220-240	18	45	7	650
Wall Spot	15W	220-240	9	24	15	550
Wall Light Lucia	6W	n/a	72	118	13,4	165
Wall Light Lucia	10W	n/a	71	119	13,6	175
Flood HO	310W	190-210	2	4	27	1500
Flood HO	620W	190-210	2	3	28,5	2820
Floodlight Performer	90W/125W/160W	190-210	11	18	35	800
Floodlight Performer	220W	180-280	3	5	66,5	540
Floodlight Modulo Performer	70W	200-300	8	22	54	200
Floodlight Modulo Performer	100W/150W	200-300	4	11	60	300
Floodlight Modulo Performer	200W	200-300	2	6	113	300
Floodlight Modulo Performer	250W	200-300	2	6	114	280
Floodlight EcoMax G2 Medium Power	30W	310	93	94	8	38,2
Floodlight EcoMax G2 Medium Power	50W	310	10	13	70	5,3
Floodlight EcoMax G2 Medium Power	70W	310	16	21	44	10,1
Floodlight EcoMax G2 Low Power	10W	200-300	50	83	3	90
Floodlight EcoMax G2 Low Power	19W	200-300	110	130	6	190





SMART

INDOOR

OUTDOOR

LAMPS & TOOLS

TECHNICAL DATA

GLOSSARY





IP Rated Product Overview

IP-rating	Indoor application	Outdoor application
IP44	Downlight Performer HG (front side)	
	Downlight Performer MW (front side)	
	Downlight Compact (front side)	
	Downlight Slim EcoMax (front side)	
	Ceiling Light Apollo	
	Ceiling Light Apollo Basic	
	Linear EcoMax	
IP54	Slim Panel Performer UGR19 G5 (non-TW, front side)	
	Wall-Mounted EcoMax G2	
IP65	Highbay EcoMax G2	Bollard Performer
	Waterproof Classic	Bollard Luke
	Waterproof Basic	Floodlight EcoMax G2 Medium Power
		Porchlight EcoMax
		Wall-Mounted Performer
		Wall Spot
		Wall Light Lucia
IP66	Highbay Performer G4	Roadlight Stratus
	Waterproof Performer G3	Roadlight EcoMax
	Waterproof EcoMax G2	Streetlight G2
		Post Top
		Flood HO
		Floodlight Performer
		Floodlight Modulo Performer
	Floodlight EcoMax G2 Low Power	
IP67/69K		Spot Projector
		Waterproof Special

For an explanation of IP protection, see the Definition of terms.



Trunking - module allocation

PARTS REQUIRED FOR ONE LED-LIGHTLINE WITH 50% LED-module allocation



Trunk length (m)	Number of LED modules	Number of 3m trunks	Number of 3m end trunks	Number of 1.5m end trunks	Number of blind plates	Number of feed-in boxes	Number of end caps	Minimum number of hanging points
1,5	1	0	0	1	0	1	1	2
4,5	2	1	0	1	1	1	1	2
7,5	3	2	0	1	2	1	1	3
10,5	4	3	0	1	3	1	1	4
13,5	5	4	0	1	4	1	1	5
16,5	6	5	0	1	5	1	1	6
19,5	7	6	0	1	6	1	1	7
22,5	8	7	0	1	7	1	1	8
25,5	9	8	0	1	8	1	1	9
28,5	10	9	0	1	9	1	1	10
31,5	11	10	0	1	10	1	1	11
34,5	12	11	0	1	11	1	1	12
37,5	13	12	0	1	12	1	1	13
40,5	14	13	0	1	13	1	1	14

PARTS REQUIRED FOR ONE LED-LIGHTLINE WITH 33% LED-module allocation

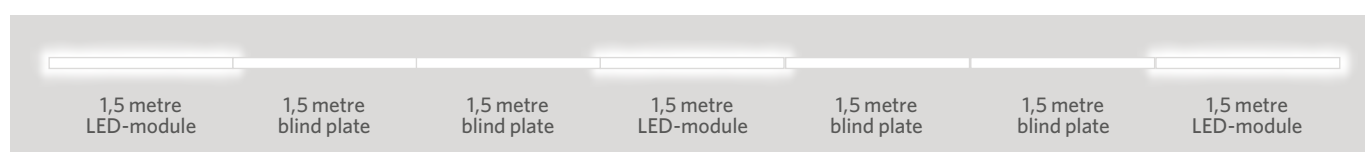

Trunk length (m)	Number of LED modules	Number of 3m trunks	Number of 3m end trunks	Number of 1.5m end trunks	Number of blind plates	Number of feed-in boxes	Number of end caps	Minimum number of hanging points
1,5	1	0	0	1	0	1	1	2
6,0	2	1	1	0	2	1	1	3
10,5	3	3	0	1	4	1	1	4
15,0	4	4	1	0	6	1	1	6
19,5	5	6	0	1	8	1	1	7
24,0	6	7	1	0	10	1	1	9
28,5	7	9	0	1	12	1	1	10
33,0	8	10	1	0	14	1	1	12
37,5	9	12	0	1	16	1	1	13
42,0	10	13	1	0	18	1	1	15



Highbay MD Controller

Motion Sensor

Luminaire is equipped with an integrated microwave motion/daylight sensor. The sensor will work immediately after the luminaire is connected, no further action required.

Factory settings	
Detection Area	100%
Hold Time	2 seconds
Stand-by Period	0 seconds
Stand-by dim Level	10%
Daylight Sensor	Disabled

To modify the factory settings. It is required to use the IR Remote Controller (Not included).

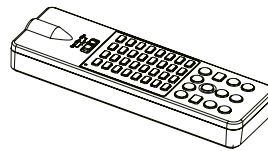
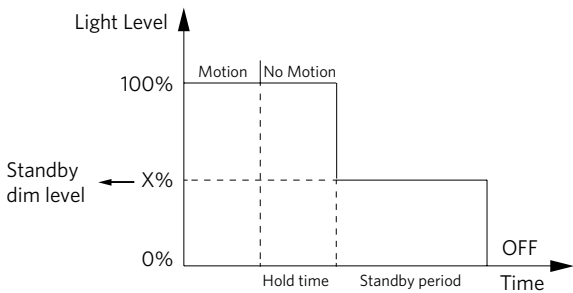

543098024500
LED HB4-Remote Controller
(Sold as accessory)

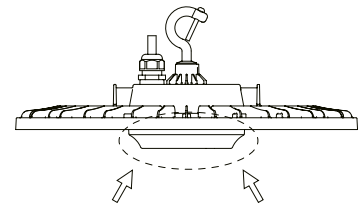

Sensor Position

Key Remote Controller functions

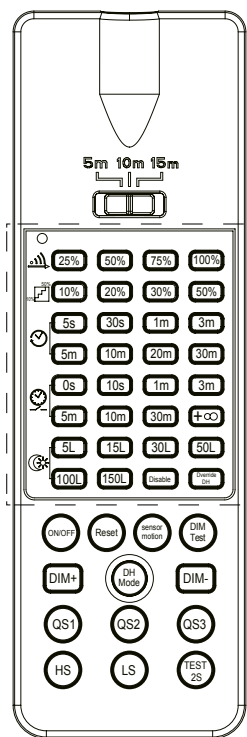

Detection Area

Size of the detection area of the sensor.

- 25%
- 50%
- 75%
- 100%

Stand-by dim Level

Dimming level of the luminaire during the Stand-by Period.

- 10%
- 20%
- 30%
- 50%

Hold Time

How much time without detecting any movement before the sensor dims the luminaire.

- 5s
- 30s
- 1m
- 3m
- 5m
- 10m
- 20m
- 30m

Stand-by Period

How much time without detecting any movement before the sensor turns off the luminaire.

- 0s
- 10s
- 1m
- 3m
- 5m
- 10m
- 30m
- +∞

Daylight Sensor

If more lux is measured by the sensor than the set value, the luminaire will not switch on when movement is detected, to save energy. The 'Disable' button will cancel this daylight sensing functionality.

- 5L
- 15L
- 30L
- 50L
- 100L
- 150L
- Disable
- Override ON



Operation

Note: Before starting ensure that luminaires are turned on, and the remote controller has batteries.

1. Set the remote sensitivity according to the mounting height of the Highbay.

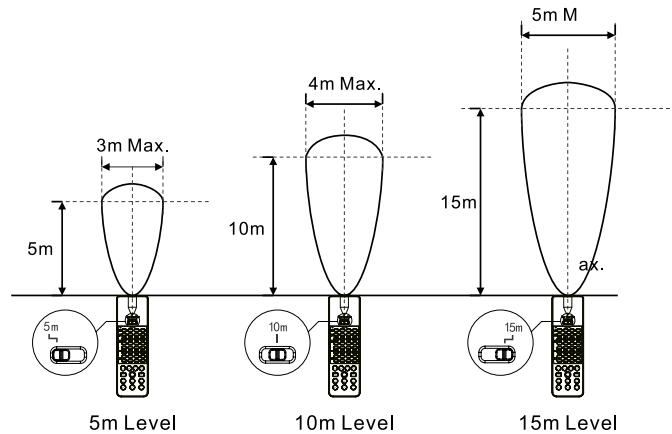
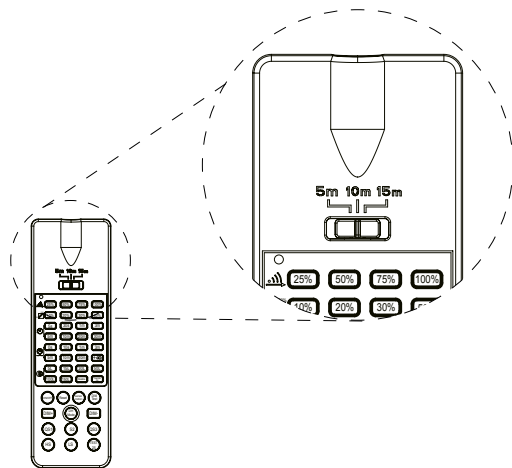

2. Point the remote facing forward towards the motion sensor of the Highbay MD, all the luminaires with sensor within range will respond to the signal.

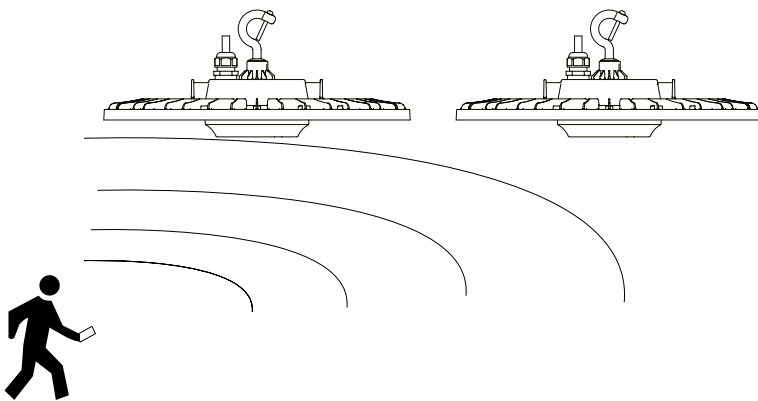

3. The luminaire indicator light (green) will flash one time after it has received the new setting.

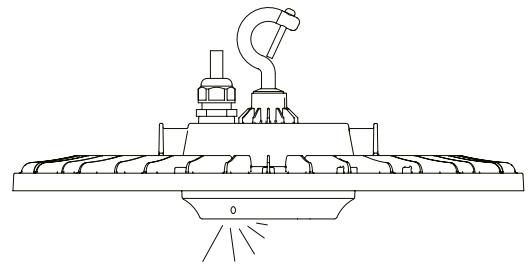

For all remote controller functions please see the Highbay MD Remote Controller Installer Instruction.

Roadlight Stratus

Possible pole distances

Maximum Pole Distances

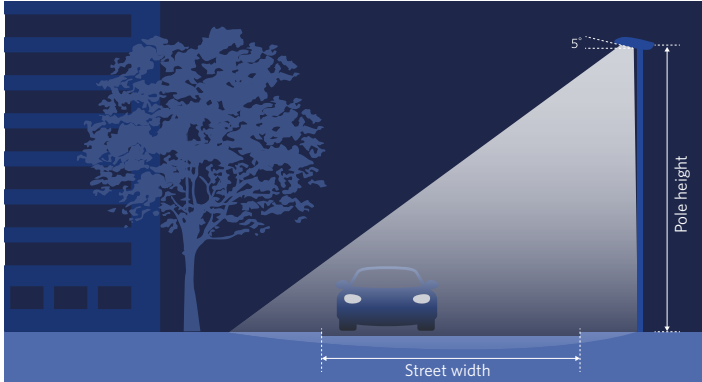

Lighting Class according to EN 13201: 2015
 Lighting Calculation details:
 • Roadway surface CIE R3 Q0: 0.07
 • Maintenance factor: 0.8
 • Arrangement type: single side bottom

All rights reserved. No rights can be derived from the provided information.

M-Class Roads

Luminaire	Illuminance Class	Width [m]	Pole distance[m]	Pole height [m]	Boom angle [°]	Light overhang [m]
LED Roadlight Stratus 60W AS	M3	10	22	8	10	1
		9	26	6,5	10	0,5
		8	28	6,5	5	0,5
		7	30	7	0	1
	M4	10	30	7	10	0,5
		9	32	7,5	10	0,5
		8	34	8,5	0	1
		7	35	8,5	0	1
LED Roadlight Stratus 80W AS	M3	10	31	8	5	1
		9	33	8	5	1
		8	34	8	5	1
		7	35	9	0	1
	M4	10	38	9	10	1
		9	40	9,5	0	1
		8	41	10	0	1
		7	42	10	0	0,5

Luminaire	Illuminance Class	Width [m]	Pole distance[m]	Pole height [m]	Boom angle [°]	Light overhang [m]
LED Roadlight Stratus 120W AS	M3	10	41	10	0	0
		9	41	10	0	0
		8	41	10	0	0
		7	41	10	0	0
	M4	10	47	11,5	5	0,5
		9	48	12	0	0
		8	49	12	5	0
		7	51	12,5	0	0
LED Roadlight Stratus 150W AS	M3	10	46	11,5	5	1
		9	47	11,5	5	1
		8	49	12	0	1
		7	50	12,5	0	1
	M4	10	55	13,5	0	0,5
		9	57	14	0	1
		8	57	14,5	0	1
		7	57	14,5	0	1

*Calculation is based on 4000K version

Polar Diagrams

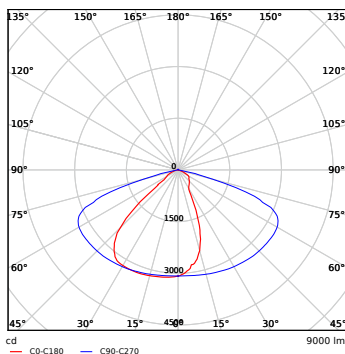

LED Roadlight Stratus-60W

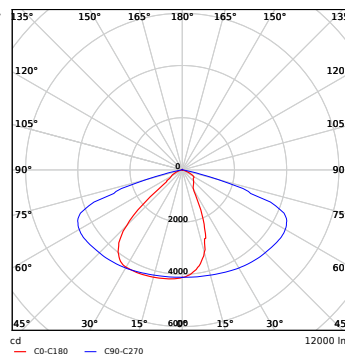

LED Roadlight Stratus-80W

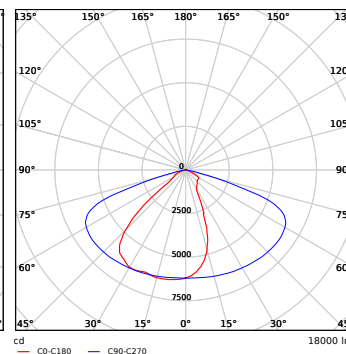

LED Roadlight Stratus-120W

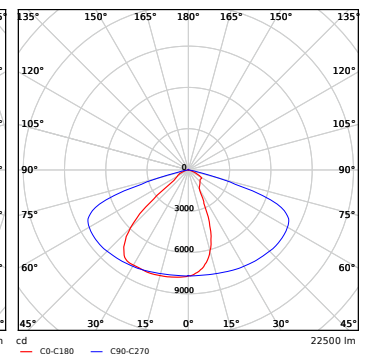

LED Roadlight Stratus-150W



Roadlight EcoMax

Possible pole distances

Maximum Pole Distances

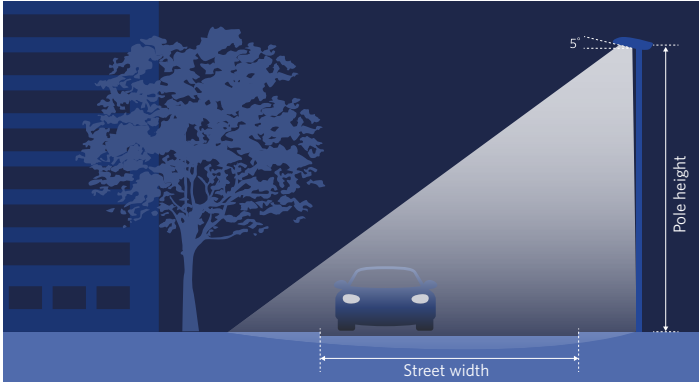

Lighting Class according to EN 13201: 2015
 Lighting Calculation details:
 • Roadway surface CIE R3 Qo: 0.07
 • Maintenance factor: 0.8
 • Arrangement type: single side bottom

All rights reserved. No rights can be derived from the provided information.

M-Class Roads

Luminaire	Illuminance Class	Width [m]	Pole distance[m]	Pole height [m]	Boom angle [°]	Light overhang [m]
LEDRoadlight-E 80W	M3	7	30	7	0	1
		8	28	7	0	1
		9	27	7	0	1
		10	25	7	5	1
		11	23	6,5	10	1
LEDRoadlight-E 80W	M4	7	36	8	5	1
		8	35	8	0	1
		9	34	7,5	0	1
		32	7,5	5	1	
		11	29	7,5	10	1

Luminaire	Illuminance Class	Width [m]	Pole distance[m]	Pole height [m]	Boom angle [°]	Light overhang [m]
LEDRoadlight-E 100W	M3	7	34	8	0	1
		8	34	7,5	0	1
		9	32	7,5	0	1
		10	30	7,5	0	1
		11	28	7	10	1
LEDRoadlight-E 100W	M4	7	41	9	0	0,5
		8	40	9	0	1
		9	39	8,5	0	1
		37	8,5	0	1	
		11	36	8,5	0	1

M-class = main road

Polar Diagrams

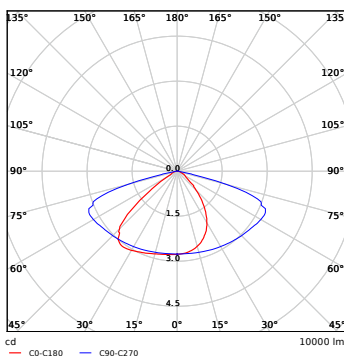

LEDRoadlight-E 80W

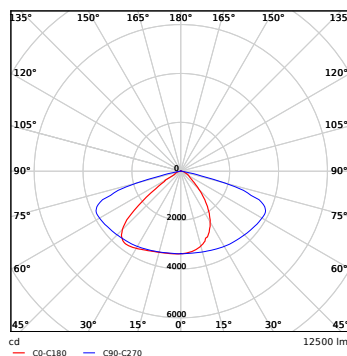

LEDRoadlight-E 100W



Streetlight G2

Possible pole distances

Maximum Pole Distances

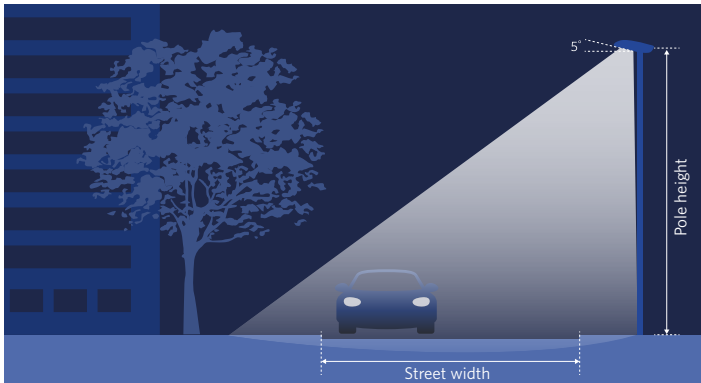

Lighting Class according to EN 13201: 2015
 Lighting Calculation details:
 • Roadway surface CIE R3 Qo: 0.07
 • Maintenance factor: 0.8
 • Arrangement type: single side bottom

All rights reserved. No rights can be derived from the provided information.

M-Class Roads

Luminaire	Illuminance Class	Street width [m]	Maximum pole distance[m]	Pole height [m]	Boom angle [°]	Light overhang [m]
LEDStreetlight-E2 20W	M5	4	26	5	5	0,1
		5	24	5	5	0,3
		6	22	5	5	0,4
	M6	4	35	7	5	0,2
		5	34	6,5	5	0,1
		6	32	6,5	5	0,5
LEDStreetlight-E2 40W	M5	4	37	7,5	5	0,4
		5	36	7	5	0,2
		6	34	7	5	0,4
	M6	4	49	10	5	0,5
		5	48	9,5	5	0,1
		6	46	9,5	5	0,5
LEDStreetlight-E2 60W	M4	5	34	8,5	5	0,3
		6	33	8,5	5	0,4
		7	32	8	5	0,4
	M5	8	30	8	5	0,5
		5	47	10	5	0,3
		6	46	9,5	5	0,3
7	44	9,5	5	0,5		
8	41	9,5	5	0,5		

M-class = main road

P-Class Roads

Luminaire	Illuminance Class	Street width [m]	Maximum pole distance[m]	Pole height [m]	Boom angle [°]	Light overhang [m]
LEDStreetlight-E2 20W	P2	3	24	4,5	5	0
		4	23	4	5	0
		5	23	4	5	0,5
	P4	6	20	4	5	0,3
		3	35	6,5	5	0,5
		4	35	6,5	5	0,3
LEDStreetlight-E2 40W	P2	5	34	6	5	0,1
		6	33	6	5	0,5
		3	32	6	5	0,4
	P4	4	32	6,5	5	0,5
		5	32	6	5	0,2
		6	31	5,5	5	0,2
LEDStreetlight-E2 60W	P2	3	47	9	5	0,1
		4	47	9	5	0,3
		5	46	9	5	0,5
	P4	6	46	8,5	5	0,3
		4	43	8,5	5	0,3
		5	42	8	5	0,1
6	41	8,5	5	0,3		
7	41	8	5	0,5		

P-class = pedestrian road

Polar Diagrams

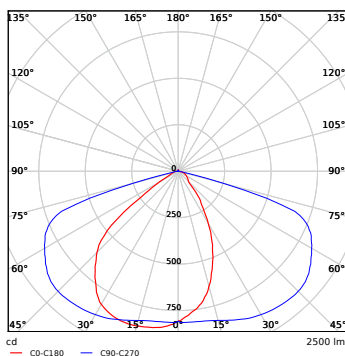

LEDStreetlight-E2 20W

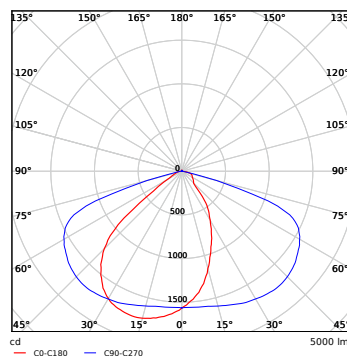

LEDStreetlight-E2 40W

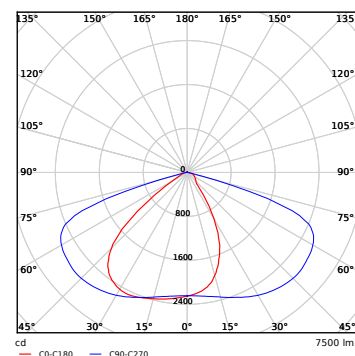

LEDStreetlight-E2 60W



Post Top

Possible pole distances

Maximum Pole Distances

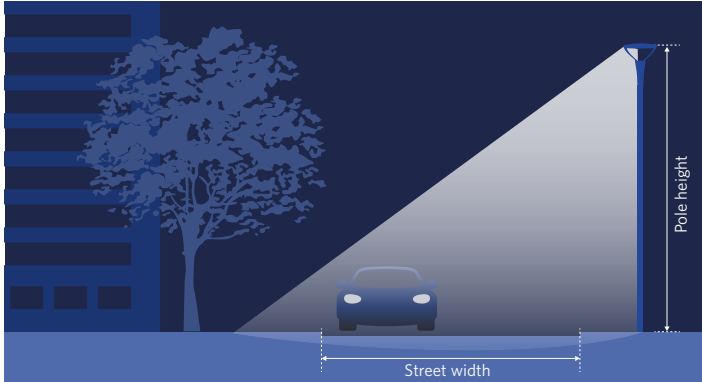

Lighting Class according to EN 13201:2015
 Lighting Calculation details:

- Roadway surface CIE R3 Qo:0.07
- Maintenance factor: 0.8
- Arrangement type: single side down

All rights reserved. No rights can be derived from the provided information.

P-Class Roads

Luminaire	Illuminance Class	Street width [m]	Maximum pole distance[m]	Pole height [m]	
LED Post Top 33W -- AS	P2	3	22	4,5	
		4	21	4,5	
		5	21	4,5	
		6	21	4	
	P3	3	25	5	
		4	25	5	
		5	25	5	
	P4	3	30	6	
		4	30	6	
		5	30	5,5	
	LED Post Top 50W -- AS	P2	3	28	5,5
			4	28	5,5
5			27	5	
6			27	5	
P3		3	32	6,5	
		4	32	6,5	
		5	31	6,5	
P4		3	40	8	
		4	39	8	
		5	39	8	
			6	38	7,5

P-class = pedestrian road

*Calculation is based on 4000K version

Polar Diagrams

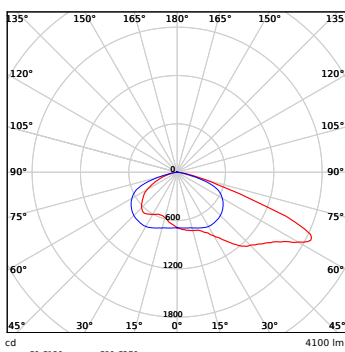

LEDPostTop-P 33W-AS

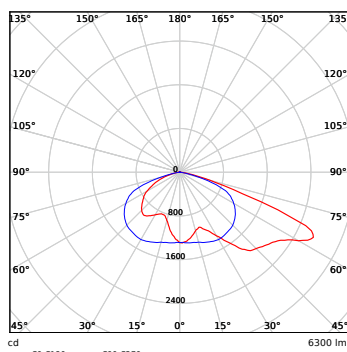

LEDPostTop-P 50W-AS



Flood HO - Configuration examples

TENNIS

Class II

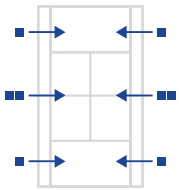

COMPETITION
SINGLE FIELD
4 X 1X 310W
2 X 1X 620W
POLE HEIGHT: 8M

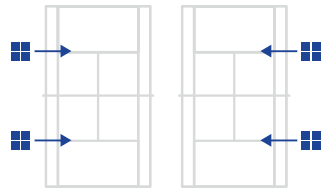

COMPETITION
DOUBLE FIELD
4 X 1240W
POLE HEIGHT: 11M

Class III

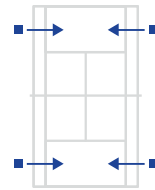

TRAINING
SINGLE FIELD
4 X 310W
POLE HEIGHT: 8M

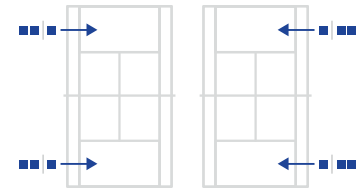

TRAINING
DOUBLE FIELD
4 X 310W + 620W
POLE HEIGHT: 11M

SOCCER

Class II

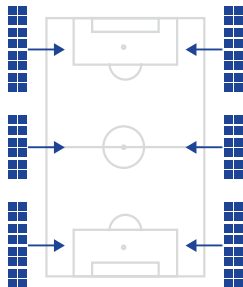

COMPETITION
PLAYING FIELD
4 X 4X 1240W
2 X 3X 1240W
POLE HEIGHT: 18M

Class III

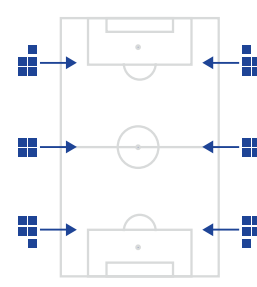

TRAINING
PLAYING FIELD
4 X 1 X 1240W
+ 1 X 310W
2 X 1 X 1240W
POLE HEIGHT: 21M

HOCKEY

Class II

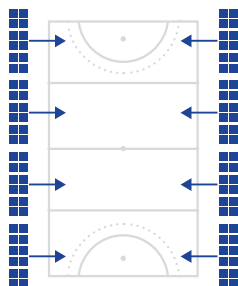

HOCKEY
PLAYING FIELD
8 X 3X 1240W
POLE HEIGHT: 18M

The calculations are indicative and not binding in any way. Please contact us for a calculation tailored to your exact situation.



EN 12193-standard for a tennis court

	class II	class III
Average light intensity	300 lx	200 lx
Light homogeneity	0.7	0.6
Colour rendering	60	20

EN 12193 standard for a soccer pitch

	class II	class III
Average light intensity	200 lx	75 lx
Light homogeneity	0.6	0.5
Colour rendering	60	20

EN 12193 standard for a hockey pitch

	class II	class III
Average light intensity	250 lx	200 lx
Light homogeneity	0.7	0.7
Colour rendering	60	20

HOW TO READ THE TABLES?

The table describes the requirements of the EN12193 standard for each sports field in terms of light intensity and colour rendering. For example, a football pitch for competition use (class II) requires a minimum of 200 lux on average, with a homogeneity of 0.6 and colour rendering of at least 60. A training field (class III) requires uniform light distribution at 75 lux as a minimum and colour rendering of at least 60.

HOW MANY LED-MODULES DO YOU NEED?

These examples are based on the standards for football pitches, hockey pitches and tennis courts. Obviously, other field sports can also be illuminated with OPPLE's Flood HO sports field lighting system. Our service desk can tell you exactly which lighting standard applies to each specific type of sports field. Feel free to contact one of our advisers in order to specify the LED lighting package you require.

Call us on our service number:

+31 88 056 7888.

We look forward to assisting you.





Smart	12
Indoor	30
Outdoor	120
Lamps & Tools	150
Technical Data	164
Glossary	182

Definition of terms

CRI (Ra)

Colour Rendering Index

A color rendering index (CRI) is a quantitative measure of the ability of a light source to reveal the colors of various objects faithfully in comparison with an ideal or natural light source.

CCT

Color temperature in Kelvin

The color temperature of a light source is the temperature of an ideal black-body radiator that radiates light of comparable color to that of the light source.

lm

lumen

The lumen (symbol: lm) is a measure of the total quantity of visible light emitted by a source

lx

lux

lumen/m²

The lux (symbol: lx) is measuring luminous flux per unit area. It is equal to one lumen per square metre. In photometry, this is used as a measure of the intensity, as perceived by the human eye, of light that hits or passes through a surface.

Efficacy

lm/W

Amount of light produced (lm) per unit of energy consumed (W) Luminous efficacy is a measure of how well a light source produces visible light. It is the ratio of luminous flux to power, measured in lumens per watt

UGR

Unified Glare Rating

The unified glare rating (UGR) is a measure of the glare in a given environment. It is basically the logarithm of the glare of all visible lamps, divided by the background lumination.

DALI/DALI2

Digital Addressable Lighting Interface

Digital Addressable Lighting Interface (DALI) is a trademark for network-based systems that control lighting in building automation.

SDCM

standard deviation of color matching

SDCM has the same meaning as a "MacAdam ellipse". A 1-step MacAdam ellipse defines a zone in the CIE 1931 2 deg (xy) colour space within which the human eye cannot discern colour difference.

Power factor (pf)

Difference between power and apparent power

The power factor of an AC electrical power system is defined as the ratio of the real power flowing to the load to the apparent power in the circuit and is a dimensionless number in the closed interval of -1 to 1. A power factor of less than one means that the voltage and current waveforms are not in phase, reducing the instantaneous product of the two waveforms.

Lifespan

L70: Rated Median Useful Life during which LED based luminaires have their luminous flux degraded to 70 % (L70) of their initial flux, but are still operating.

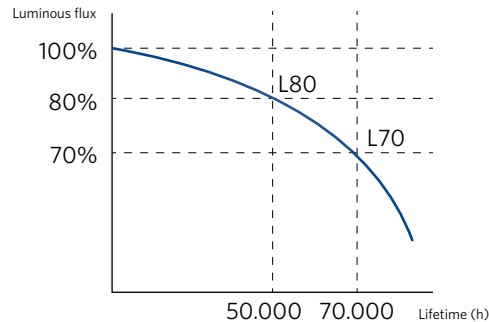

L70 is as described in IEC 62717 and IEC 62722-2-1.

Input current

The steady state current which a device uses from the net after switch-on

Inrush Current

The maximum current that will occur during a short period of time after switching on of the luminaire.

IP

International Protection Rating

- The IP Code, International Protection Marking, IEC standard 60529, sometimes interpreted as Ingress Protection Marking, classifies and rates the degree of protection provided against intrusion (body parts such as hands and fingers), dust, accidental contact, and water by mechanical casings and electrical enclosures. It is published by the International Electrotechnical Commission (IEC). The equivalent European standard is EN 60529.
- The IP code consists of two digits. First digit: Solid particle protection. Second digit: Liquid ingress protection

1. The first digit indicates the level of protection that the enclosure provides against access to hazardous parts

- IP 0* No protection against contact and ingress of objects
- IP 1* Any large surface of the body, such as the back of a hand, but no protection against deliberate contact with a body part (> 50 mm)
- IP 2* Fingers or similar objects > 12.5 mm)
- IP 3* Tools, thick wires, etc. > 2.5mm)
- IP 4* Most wires, slender screws, large ants etc. 1 mm
- IP 5* Ingress of dust is not entirely prevented, but it must not enter in sufficient quantity to interfere with the satisfactory operation of the equipment.
- IP 6* No ingress of dust; complete protection against contact (dust tight). A vacuum must be applied. Test duration of up to 8 hours based on air flow.



2. The second digit indicates the level of protection that the enclosure provides against harmful ingress of water.

- IP *0 None
- IP *1 Dripping water (vertically falling drops) shall have no harmful effect on the specimen when mounted in an upright position onto a turntable and rotated at 1 RPM.
- IP *2 Vertically dripping water shall have no harmful effect when the enclosure is tilted at an angle of 15° from its normal position. A total of four positions are tested within two axes.
- IP *3 Water falling as a spray at any angle up to 60° from the vertical shall have no harmful effect, utilizing either:
- an oscillating fixture, or
 - A spray nozzle with a counterbalanced shield. Test a) is conducted for 5 minutes, then repeated with the specimen tilted 90° for the second 5-minute test. Test b) is conducted (with shield in place) for 5 minutes minimum.
- IP *4 Water splashing against the enclosure from any direction shall have no harmful effect, utilizing either: a) an oscillating fixture, or b) A spray nozzle with no shield. Test a) is conducted for 10 minutes. Test b) is conducted (without shield) for 5 minutes minimum.
- IP *5 Water projected by a nozzle (6.3 mm) against enclosure from any direction shall have no harmful effects.
- IP *6 Water projected in powerful jets (12.5 mm nozzle) against the enclosure from any direction shall have no harmful effects.
- IP *7 Ingress of water in harmful quantity shall not be possible when the enclosure is immersed in water under defined conditions of pressure and time (up to 1 m of submersion).
- IP *8 The equipment is suitable for continuous immersion in water under conditions which shall be specified by the manufacturer. However, with certain types of equipment, it can mean that water can enter but only in such a manner that it produces no harmful effects. The test depth and/or duration is expected to be greater than the requirements for IPx7, and other environmental effects may be added, such as temperature cycling before immersion.
- IP *9K Protected against close-range high pressure, high temperature spray downs. Smaller specimens rotate slowly on a turntable, from 4 specific angles. Larger specimens are mounted upright, no turntable required, and are tested freehand for at least 3 minutes at distance of 0.15–0.2 m."

IK

This is an international numeric classification for the degrees of protection provided by enclosures for electrical equipment against external mechanical impacts. It provides a means of specifying the capacity of an enclosure to protect its contents from external impacts.

The most common IK values are:

- IK 02 Impact Resistance 0.2 Joules
Standard impact resistance, for example, a standard fixture
- IK 04 Impact Resistance 0.5 Joules
Standard Plus impact resistance, for example, a standard luminaire with an enhanced optical system
- IK 07 Shock resistance 2 Joule
Fortified fixture, for example, a standard fixture with a grid

- IK 08 Resistance to shock of 5 Joules
Vandalism protective fixture, such as a closed luminaire with polycarbonate or glass shade
- IK 10 Shock resistance 20 Joules
Vandal-proof fixture, for example a closed luminaire

SKG

SKG has developed into the partner for safeguarding the long-term performance and safety of industrial products for the building envelope.

Protection class

IEC protection classes are defined in IEC 61140 and used to differentiate between the protective-earth connection requirements of devices. These appliances must have their chassis connected to electrical earth.

- Class 0 These appliances have no protective-earth connection and feature only a single level of insulation between live parts and exposed metalwork. If permitted at all, Class 0 items are intended for use in dry areas only.
- Class 1 These appliances must have their chassis connected to electrical earth (US: ground) by a separate earth conductor (coloured green/yellow in most countries, green in the US, Canada and Japan). The earth connection is achieved with a 3-conductor mains cable, typically ending with 3-prong AC connector which plugs into a corresponding AC outlet.
- Class 0I Electrical installations where the chassis is connected to earth with a separate terminal, instead of via the mains cable. In effect this provides the same automatic disconnection as Class I, for equipment that otherwise would be Class 0
- Class 2 A Class II or double insulated electrical appliance is one which has been designed in such a way that it does not require a safety connection to electrical earth (ground).
- Class 3 A Class III appliance is designed to be supplied from a separated/safety extra-low voltage (SELV) power source. The voltage from a SELV supply is low enough that under normal conditions a person can safely come into contact with it without risk of electrical shock. The extra safety features built into Class I and Class II appliances are therefore not required. For medical devices, compliance with Class III is not considered sufficient protection, and further more-stringent regulations apply to such equipment.

Flicker free

Flicker is the fluctuation of the light output of a luminaire or lamp in time. The amount of flicker is expressed by the flicker percentage. If the flicker percentage is categorized as "no risk" according to the IEEE1789 standard, OPPL categorizes the product as being "flicker free".

D-Mark

According to VDE 0711 Part 2 – 24, luminaires bearing this symbol, due to their limited surface temperatures, are suitable for installations where dust material presents a fire hazard.



Glossary

Glossary general

CCT

Color temperature in Kelvin

CRI (Ra)

Colour Rendering Index

DALI

Digital Adressable Lighting Interface

Efficacy

lm/W

Amount of light produced (lm) per unit of energy consumed (W)

IK

Impact resistance

Input current

The maximum, instantaneous input current drawn by an electrical device when first turned on

Inrush Current

The maximum current that will occur during a short period of time after switching on of the luminaire.

IP

Ingress Protection Rating

L70

Rated Median Useful Life during which LED based luminaires have their luminous flux degraded to 70 % (L70) of their initial flux, but are still operating

lm

lumen

luminous flux

lx

lux

lumen/m²

Power factor (pf)

Difference between power and apparent power

Displacement factor (DF)

The phase shift between voltage and current at the fundamental line frequency ($\cos \phi$)

SDCM

standard deviation of color matching

UGR

Unified Glare Rating

Glare reduction

Glossary Opplé - abbreviation

100pct

100 percent

3C-P

3 phase track performer

AL

Aluminum

AS

Asymmetric beam angle

BA

Brushed aluminum

B

Basic

BL

Black

BL

Blister

CL

Clear

CT

Carton

Dim

Dimmable

E2 / HQ2 / G2

2nd Generation

EM1 / EM3

Emergency lighting 1 hour / 3 hours

FR

Frosted

G

Grille

HG

High Gloss

L12

Length 1200mm



MD
Motion/day-light detection

MW
Matt white

N
Narrow

P
Performer

PMMA
Polymethylmethacrylaat

Rc
recessed

Re
Rectangle

S / SI
Slim

SI-E
Slim EcoMax

Sp-Z
Suspended Zenith

Sq
Square

TW
Tunable White

U19
UGR value ≤ 19

W
Wide beam angle

WH
White

XN
Extra narrow

ZH
Zhaga

OPPLE

OPPLE LIGHTING

Meerenakkerweg 1-07
5652 AR Eindhoven, The Netherlands

T +31 (0) 88 056 7888

E service@opple.com

OPPLE.COM