

# eConcept

T É C N I C O





# eConcept

T É C N I C O



# motivos

motif/motifs/motives

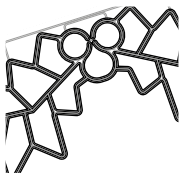

Colección Straight 26

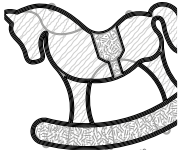

Colección Toy 40



Colección Curly 48

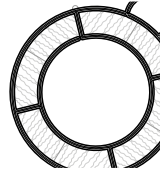

Colección Fantasy 60

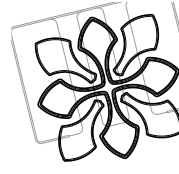

Colección Edén 60

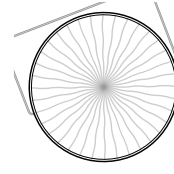

Colección Helix 70



Letras Corporeas 76



Letreros 79

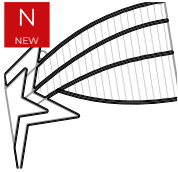

Calle 100



Farola, Calle y Fachada 111

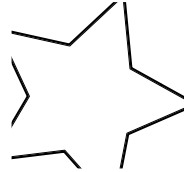

Mini 147



Accesorios 157



3D 158

# Sistemas dinámicos

Dynamic systems/Systèmes dynamiques/Sistemas dinámicos

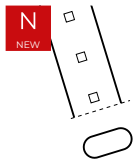

Flexilight Maxibrillo RGB 228



Flexilight Double Neon RGB 229

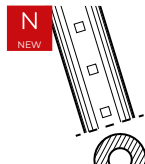

Flexilight RGBWW 230

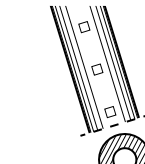

Flexilight RGB 231

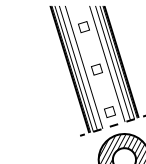

Flexilight CW-WW 232

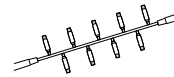

String Plus100 RGBWW 233

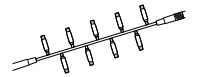

String Plus100 RGB 234

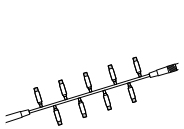

String Plus100 CW-WW 235

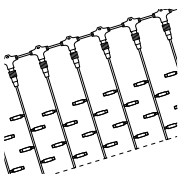

Screenlight RGB 236

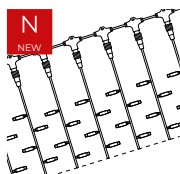

Screenlight RGBWW 237

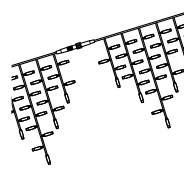

Icicle RGB 238

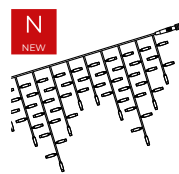

Icicle RGBWW 239

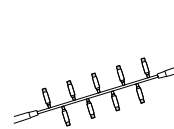

String Plus100 24V Transfor. 242



String Plus100 24V Fuente ali. 244



String PIXELMAX 248

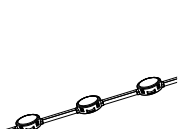

Dot DMX PIXELMAX 252

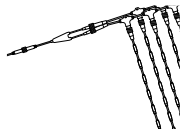

Screen PIXELMAX 254

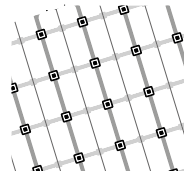







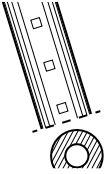
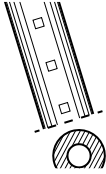
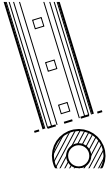
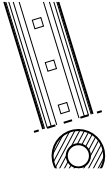
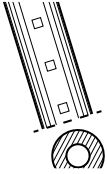
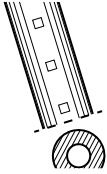
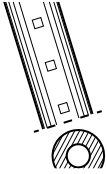
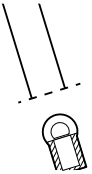

Mesh PIXELMAX 256



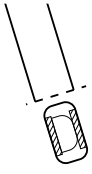

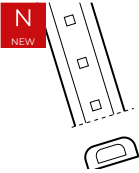
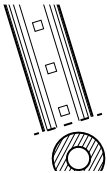
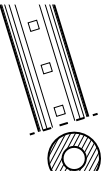
Accesorios 260

# Flexilight

						
Flexilight Led 24V 274	Flexilight Led 24V Flashing 275	Flexilight Led 276	Flexilight Led Flashing 277	Flexilight Led B. Vertical 278	Flexilight Led Dual 279	Flexilight Led Avant IP67 280
						
Flexilight Led Neon 282	Flexilight Led Neon 360° 283	Flexilight Led Mini Neon Slim 284	Flexilight Led Mini Neon 285	Flexilight Led Double Neon 286	Flexilight Led Double Neon 24V 287	Flexilight Led Maxibrillo 288
						
Flexilight Led Brite 289	Flexilight Led Instant Liso 290	Flexilight Led Ø11mm 291	Accessorios 292			

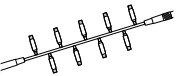
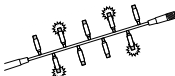
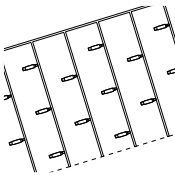
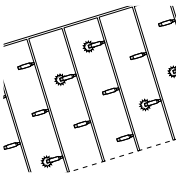
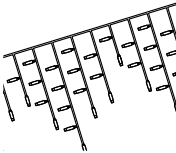
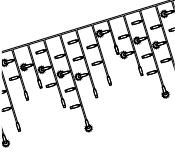
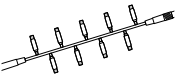
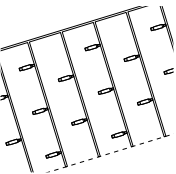
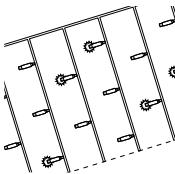
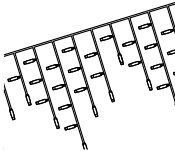
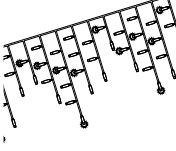
# minimalist

						
String Plus100 Exterior 304	String Plus100 Flashing Ext. 305	Screenlight Exterior 306	Screenlight Flashing Ext. 311	Icicle Exterior 316	Icicle Flashing Exterior 317	String Plus100 Interior 318
						
Screenlight Interior 319	Screenlight Flashing Int. 323	Icicle Interior 326	Icicle Flashing Interior 327	Accessorios 328		

# Led Exterior

Outdoors Led/Led à l'extérieur/Led ao ar livre

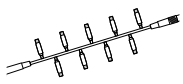

String Avant IP67 332

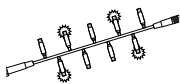

String Avant Flashing IP67 333

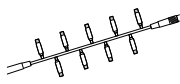

String Plus 180 24V fuente al. 334

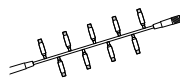

String Plus 180 24V transf. 336

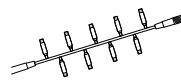

String Plus 180 1seccion 337

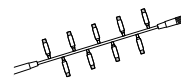

String Plus 180 338

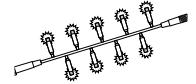

String Plus 120 ALL Flashing 437

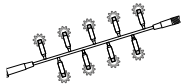

String Plus 180 Sparkle 437

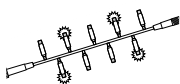

String Plus 180 Flashing 438

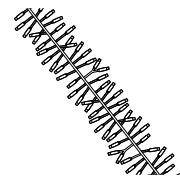

Cluster Light Fall Lite 438

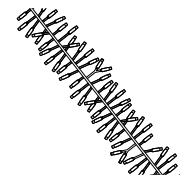

Cluster Light Flashing 439

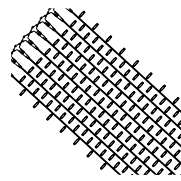

Techo Luz Screen-light Flash 440

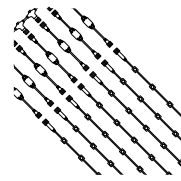

Techo Luz 441

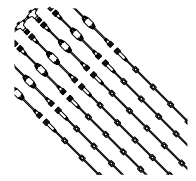

Techo Luz Flashing 441

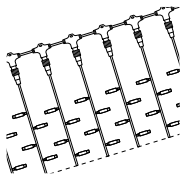

Screenlight 24V 443

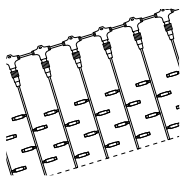

Screenlight 444

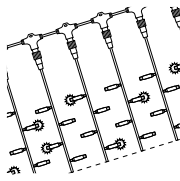

Screenlight Flashing 447

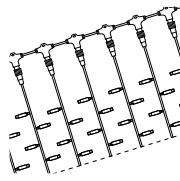

Screenlight Dual 448

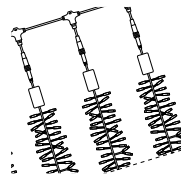

Screenlight 250 Fall Lite 449

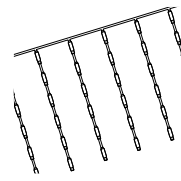

Screen Rain 450

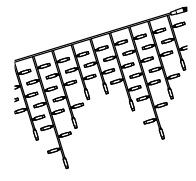

Icicle 451

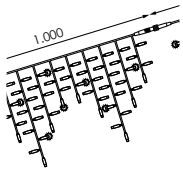

Icicle Flashing 452

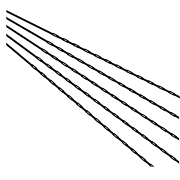

Cascada 453

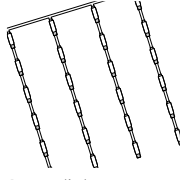

Screenlight Cascada 456

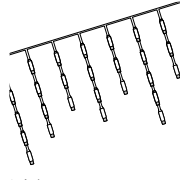

Icicle Cascada 373

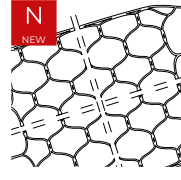

Red 24V 460

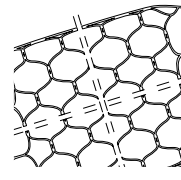

Red 457

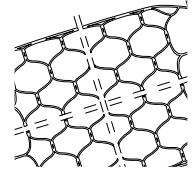

Red Flashing 454



Accesorios 468

# Led Interior

Indoors Led/Led à l'intérieur/Led interior

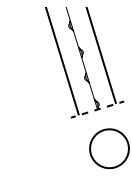

Flexilight Ø7mm 391

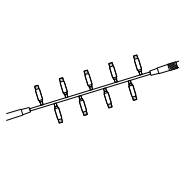

String Plus 180 392

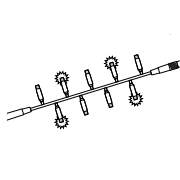

String Plus 180 Flashing 393

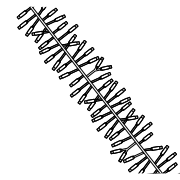

Cluster Light Fall Lite 394

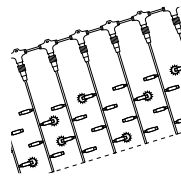

Screenlight Flashing 396

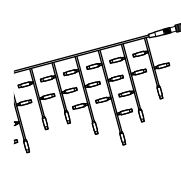

Icicle 398

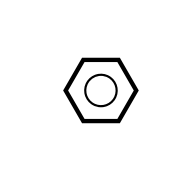

Accesorios 400

						
Cluster Microled 404	Icicle Microled 405	Branch Tree 406	Branch String 407	Solar String 408	LED Fireworks 409	Nesso 410
						
Nesso Steady 412	Giro Snowflake 414	Willow Light 416	LED Fountain 418	Deco Branch 419	Branch LED 420	Spiral 421
						
Snow Tree 422	Golden Tree 423	Willow Tree 424	Birch Tree 425	Birch Forest Tree 426	Winter Tree 427	Christmas Tree 428
						
Ball 3D Microled 430	Star Gold Line 3D 431	Star Flat 432	Star Copper 432	Star Glass Balls 433	Cluster Glass Balls 433	Cotton Balls 434
						
Glass Balls Chain 435	esSense Plastic Balls 435	Spike Star 436	Glitter Star 436	Glitter Loop 437	Candy Cane 437	Ocean Comet 438
						
Ocean Star 438	Ocean Cone 439	Elegant Cone 440	Elegant Gift 441	Elegant Deer 441	Glacier Deer Set 443	Christmas Balls 444
						
Cluster Balls 448	Branch 449	Tapiz 450	Garland 451	Tapiz NET 452	PVC NET 453	Fall Lite Led Smart 454

# deco



Fall Lite LED 456



Lámparas LED 457

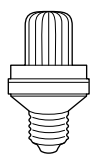

Flash Light LED 460

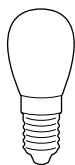

Lámparas Incandescencia 439

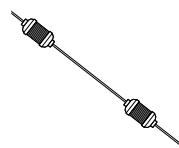

String Flash 462

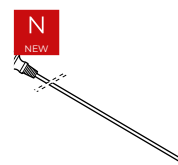

Stalactite Garland 466

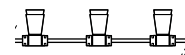

Guirnalda E27 466

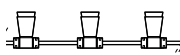

Guirnalda E14/E27 466



Accesorios 468

## Anexos

Annexes/Annexes/Anexos

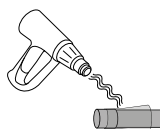

Guía Mantenimiento 472

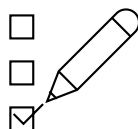

Certificaciones 476



Condiciones de Uso 476



Condiciones de Garantía 476



Condiciones de Venta 476



Simbología 477









# PRILUX

## Ñ

Prilux es una empresa con más de 35 años de experiencia en el sector de la iluminación. Focalizada en I+D+i, ayudamos a las empresas, instituciones y propiedad final a iluminar sus espacios a través de productos y soluciones tecnológicas fiables, innovadoras, personalizadas, escalables y de alto valor añadido.

Nuestro objetivo es ofrecer al sector soluciones de iluminación inteligente en todas las áreas mediante el uso de sistemas de control y regulación. Por esta razón desarrollamos tecnología propia que permite una gestión óptima del consumo, mejorar el confort y generar un importante ahorro económico de forma sostenible.

Personalización, flexibilidad, eficiencia y sostenibilidad son los valores que nos mueven a diseñar y fabricar luminarias y tecnología para nuestros clientes.

Somos una ingeniería de valor en proyectos de alumbrado público, industrial, deportivo, arquitectural y festivo/navideño.

## E

Prilux is a company with over 35 years' experience in the lighting sector. Focusing on R&D&i, we help companies, institutions and final owners light their spaces using reliable, innovative, customised, scalable technological products and solutions with high added value.

Our aim is to provide the sector with smart lighting solutions in all areas, making use of control and regulating systems. We develop our own technology for this reason, to enable optimal management of consumption, improve comfort and generate significant economic savings sustainably.

Customisation, flexibility, efficiency, and sustainability are values that drive us in designing and manufacturing luminaires and technology for our customers.

We are a value engineering company in public, industrial, sporting, architectural and festive/ Christmas lighting projects.



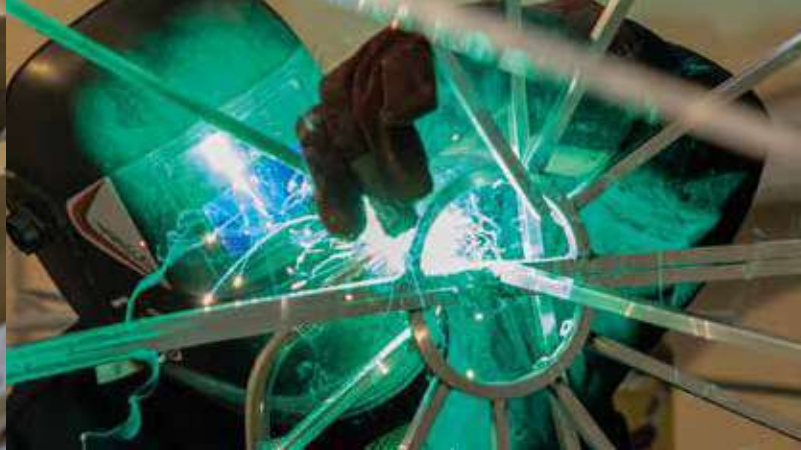

## F

Prilux est une entreprise qui jouit de plus de 35 ans d'expérience dans le secteur de l'éclairage. Axée sur la R+D+i, nous aidons les entreprises, les institutions et les propriétaires finaux à éclairer leurs espaces grâce à des produits et des solutions technologiques fiables, innovatrices, personnalisées, évolutives et à forte valeur ajoutée.

Notre objectif : proposer au secteur des solutions d'éclairage intelligent dans tous les domaines à l'aide de systèmes de contrôle et de régulation. C'est pour cette raison que nous développons notre propre technologie de sorte à permettre une gestion optimale de la consommation, à améliorer le confort et à donner lieu à une importante économie d'énergie de manière durable.

Personnalisation, souplesse, efficacité et durabilité sont les valeurs qui nous encouragent à concevoir et à fabriquer des luminaires et une technologie adaptés à nos clients.

Nous sommes une entreprise d'ingénierie de grande valeur, qui travaille sur des projets d'éclairage public, industriel, sportif, architectural et festif/de Noël.

## P

A Prilux é uma empresa com mais de 35 anos de experiência no setor da iluminação. Focada em I+D+i, ajudamos as empresas, instituições e proprietários finais a iluminar os seus espaços através de produtos e soluções tecnológicas fiáveis, inovadoras, personalizadas, escaláveis e de elevado valor acrescentado.

O nosso objetivo é oferecer ao setor soluções de iluminação inteligente em todas as áreas, recorrendo à utilização de sistemas de controlo e regulação. Por este motivo desenvolvemos tecnologia própria que permite uma gestão otimizada do consumo, melhorar o conforto e gerar uma significativa poupança económica de forma sustentável.

Personalização, flexibilidade, eficiência e sustentabilidade são os valores que nos motivam a conceber e fabricar luminárias e tecnologia para os nossos clientes.

Somos uma empresa de engenharia de valor em projetos de iluminação pública, industrial, desportiva, arquitetural e festiva/natalícia.

# Infraestructuras

Infrastructures

Infraestructuras

Infraestructuras

## Toledo

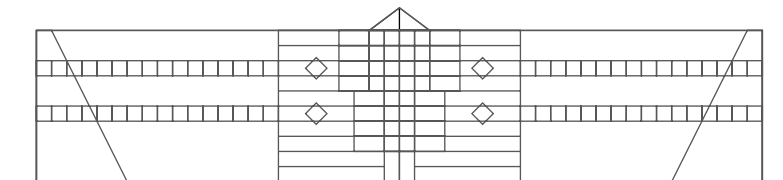

**16.500m<sup>2</sup>**

Almacén y centro productivo  
Warehouse & Production centre  
Stockage et centre de production  
Armazém e centro produtivo



**200m<sup>2</sup>**

Laboratorio  
Laboratories  
Laboratoires  
Laboratório



**300m<sup>2</sup>**

Salas limpias  
Clean rooms  
Salles blanches  
Salas limpas



**3.000m<sup>2</sup>**

Showrooms  
Showrooms  
Showrooms  
Showrooms

### Ñ

Con sede central en Toledo y delegación en Sant Llorenç d'Hortons (Barcelona), Prilux cuenta con modernas y amplias instalaciones que albergan espacios de oficina, conferencias, showrooms de exposición, laboratorio, almacenamiento, producción y salas limpias.

Además, nuestra delegación noreste actúa como plataforma logística para dar soporte al mercado internacional en Europa.

### E

With its headquarters in Toledo and branch in Sant Llorenç d'Hortons (Barcelona), Prilux has modern and extensive infrastructure housing storage, work and exhibition spaces such as: warehouses, production centres, laboratories, clean rooms, showrooms, training rooms and offices.

Also our northeast branch serves as a logistics platform for our expansion across Europe.

# Sant Llorenç d'Hortons (Barcelona)

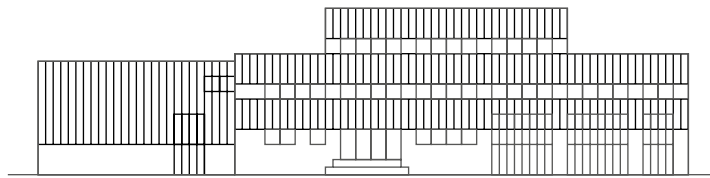

**13.000m<sup>2</sup>**

Almacén y centro productivo  
Warehouse & Production centre  
Stockage et centre de production  
Armazém e centro produtivo



**13**

Muelles de carga  
Loading bays  
Quais de chargement  
Cais de carga



**2.000m<sup>2</sup>**

Oficinas  
Offices  
Bureaux  
Escritórios



**2**

Showrooms  
Showrooms  
Showrooms  
Showrooms

## F

Le siège central de Prilux se trouve à Tolède et une antenne à Sant Llorenç d'Hortons (Barcelona), Prilux dispose d'infrastructures qui hébergent des espaces de stockage, de travail et d'exposition : entrepôts, centres de production, laboratoires, salles blanches, showrooms, salles de formation et bureaux.

De plus, notre délégation du Nord-est est une plate-forme logistique pour notre expansion en Europe.

## P

Com a sede central situada em Toledo e delegação em Sant Llorenç d'Hortons (Barcelona), Prilux dispõe de infraestruturas que compreendem espaços de armazenamento, trabalho e exposição como: armazéns, centros de produção, laboratórios, salas limpas, showrooms, salas de formação e escritórios.

Além disso, nossa delegação do noreste funciona como plataforma logística para a nossa expansão na Europa.

# Prilux around the world



Ñ

Tras 25 años centrados en el mercado español, exportamos principalmente a Europa, Europa del Este, Norte de África, Oriente Medio y América del Sur.

E

After 25 years focusing on the Spanish market, we export mainly to Europe, Eastern Europe, North Africa, the Middle East, South and America.

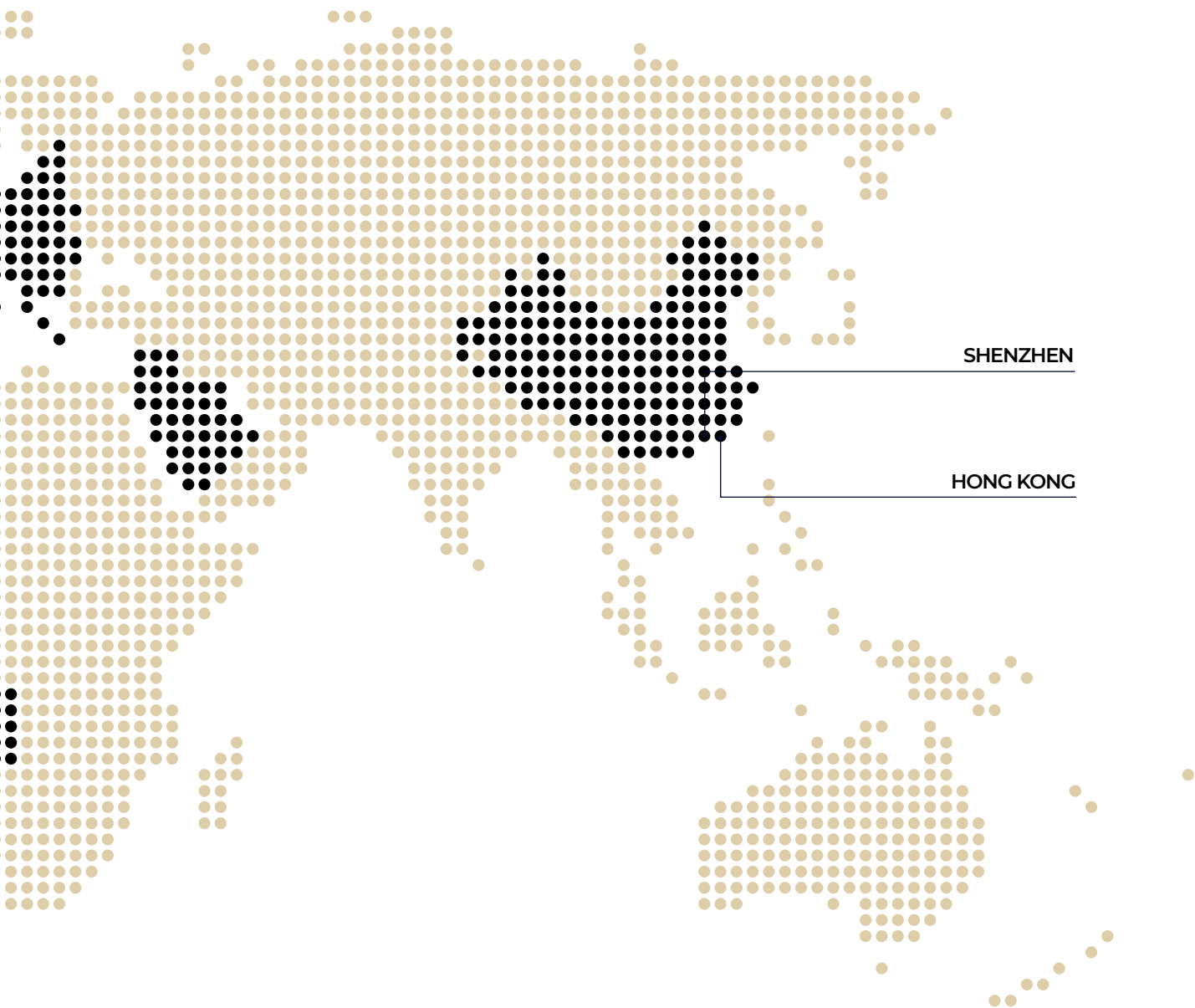

**F**

Après 25 ans centrés sur le marché espagnol, nous exportons principalement vers l'Europe, l'Europe de l'Est, l'Afrique du Nord, le Moyen Orient et l'Amérique du Sud

**P**

Após 25 anos concentrados no mercado espanhol, exportamos sobretudo para a Europa, Europa de Leste, Norte de África, Médio Oriente e América do Sul.

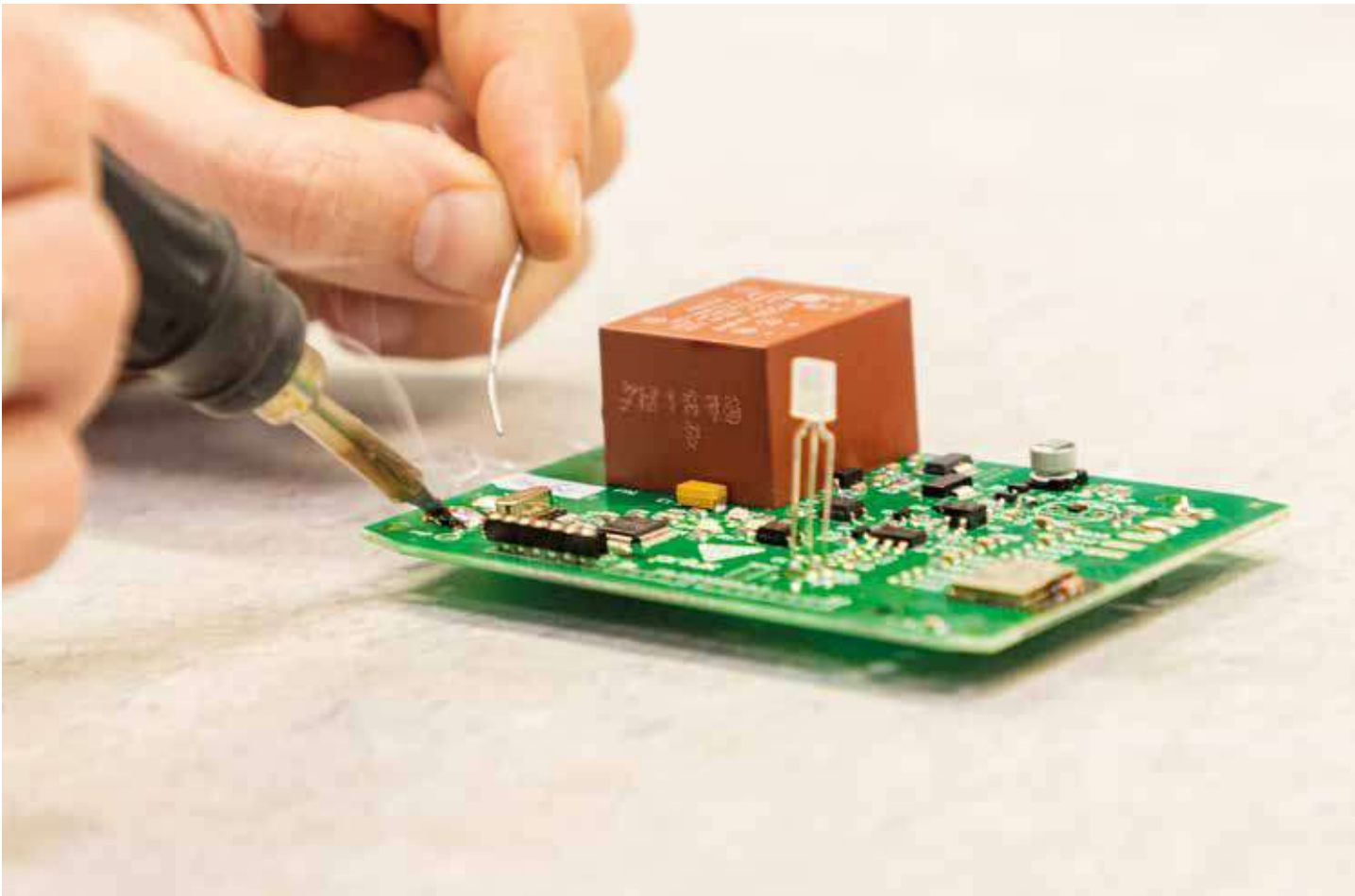

## I+D+i R&D&i

### Ñ

La innovación se ha convertido en una estrategia imprescindible para adaptarnos al mercado y su constante evolución. En Prilux apostamos por el futuro y nos apasiona diferenciar nuestros productos y soluciones explorando nuevos caminos a través de proyectos con varios horizontes temporales.

Trabajamos bajo softwares de última tecnología para mejorar la calidad de nuestros productos y adaptarnos a los cambios en el sector de forma ágil. Además, empleamos herramientas de simulación para predecir comportamientos y optimizar las soluciones.

### E

Innovation is strategic and essential for Prilux in its commitment to the future. At Prilux we are committed to the future and are passionate about differentiating our products and solutions by exploring new avenues in projects with varying timescales.

We work using state-of-the-art software to improve the quality of our products and adapt swiftly to changes in the sector. We also use simulation tools to predict behaviour and optimise solutions.



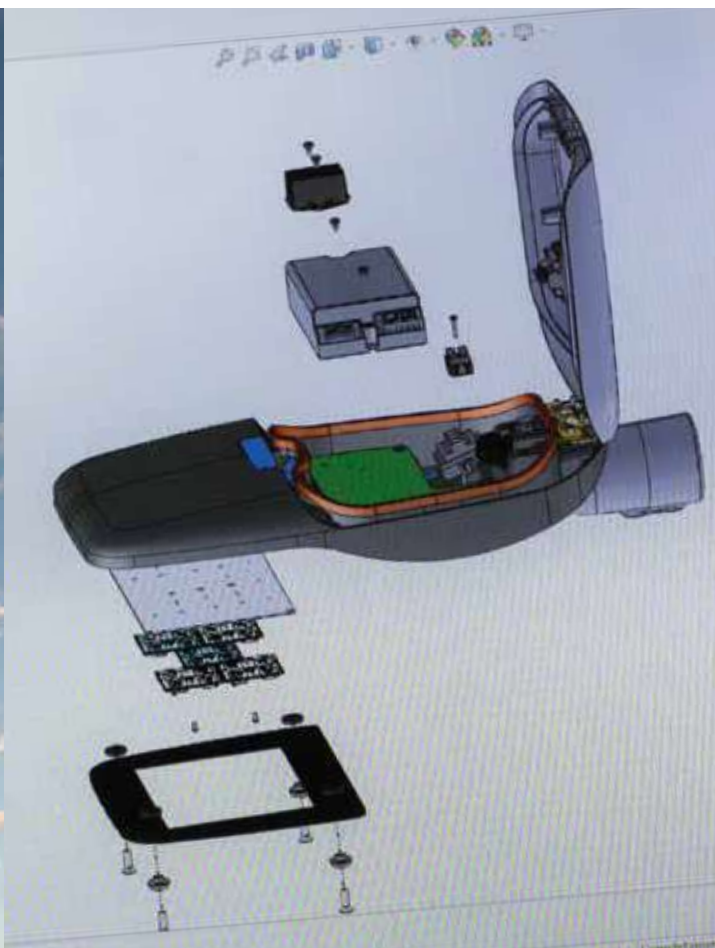

## F

Pour Prilux, l'innovation est stratégique et indispensable pour tenir notre pari sur l'avenir. Prilux mise sur l'avenir et n'a de cesse de différencier produits et solutions, et d'explorer de nouvelles voies à travers des projets s'étendant sur divers horizons de temps.

Nous travaillons avec des logiciels de pointe pour améliorer la qualité de nos produits et nous adapter avec souplesse aux changements que vit le secteur. Nous utilisons également des outils de simulation pour prédire les comportements et optimiser les solutions.

## P

A inovação para a Prilux é estratégica e indispensável ao apostar no futuro. Na Prilux apostamos no futuro e apaixonamos-nos diferenciar os nossos produtos e soluções explorando novos caminhos através de projetos com vários horizontes temporais.

Trabalhamos com softwares de última geração para melhorar a qualidade dos nossos produtos e nos adaptarmos às mudanças no setor de forma ágil. Além disso, utilizamos ferramentas de simulação para prever comportamentos e otimizar as soluções.

# Producción y Calidad

Production and quality

Fabrication et Qualité

Produção e Qualidade

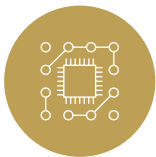

**Módulos LED propios**  
Own LED modules  
Modules LED propres  
Módulos LED próprios



**Control de calidad**  
Quality control  
Contrôle de qualité  
Controlo de qualidade



**Trazabilidad**  
Traceability  
Traçabilité  
Leitura



**Certificado ENEC (AENOR)**  
ENEC certification (AENOR)  
certificat ENEC (AENOR)  
certificado ENEC (AENOR)

## Ñ

Contamos con una “sala Blanca” equipada con una línea automática de montaje de componentes SMD (Serigrafía – Pick & Place – Horno) donde fabricamos todos nuestros módulos LED destinados a las soluciones lumínicas “made in Spain”.

Prilux dispone de un departamento de Calidad especializado tanto en la Calidad de Producto, como en el control de la Calidad Total empresarial que emplea la herramienta CERTOOL de AENOR para la gestión de la calidad y mejora continua de nuestros procesos. Este seguimiento permite ofrecer un servicio que cumpla con las especificaciones atribuidas en su totalidad.

Contamos con familias de productos con certificado ENEC, concedido por AENOR, que garantiza la calidad y seguridad de los productos, tanto en todo el proceso de fabricación, como cuando se introducen en el mercado.

## E

We have a “clean room” equipped with an automatic SMD component assembly line (Screen Printing – Pick & Place – Oven) where we manufacture all our LED modules for “made in Spain” lighting solutions.

Prilux has a Quality department specialising both in Product Quality and in corporate Total Quality control which uses AENOR’s CERTOOL tool for quality management and continuous improvement of our processes. This monitoring means it can offer a service that meets all attributed specifications in full.

We have product families with ENEC certification, granted by the Spanish standards organisation AENOR, guaranteeing product quality and safety, both throughout the manufacturing process and when they are placed on the market.



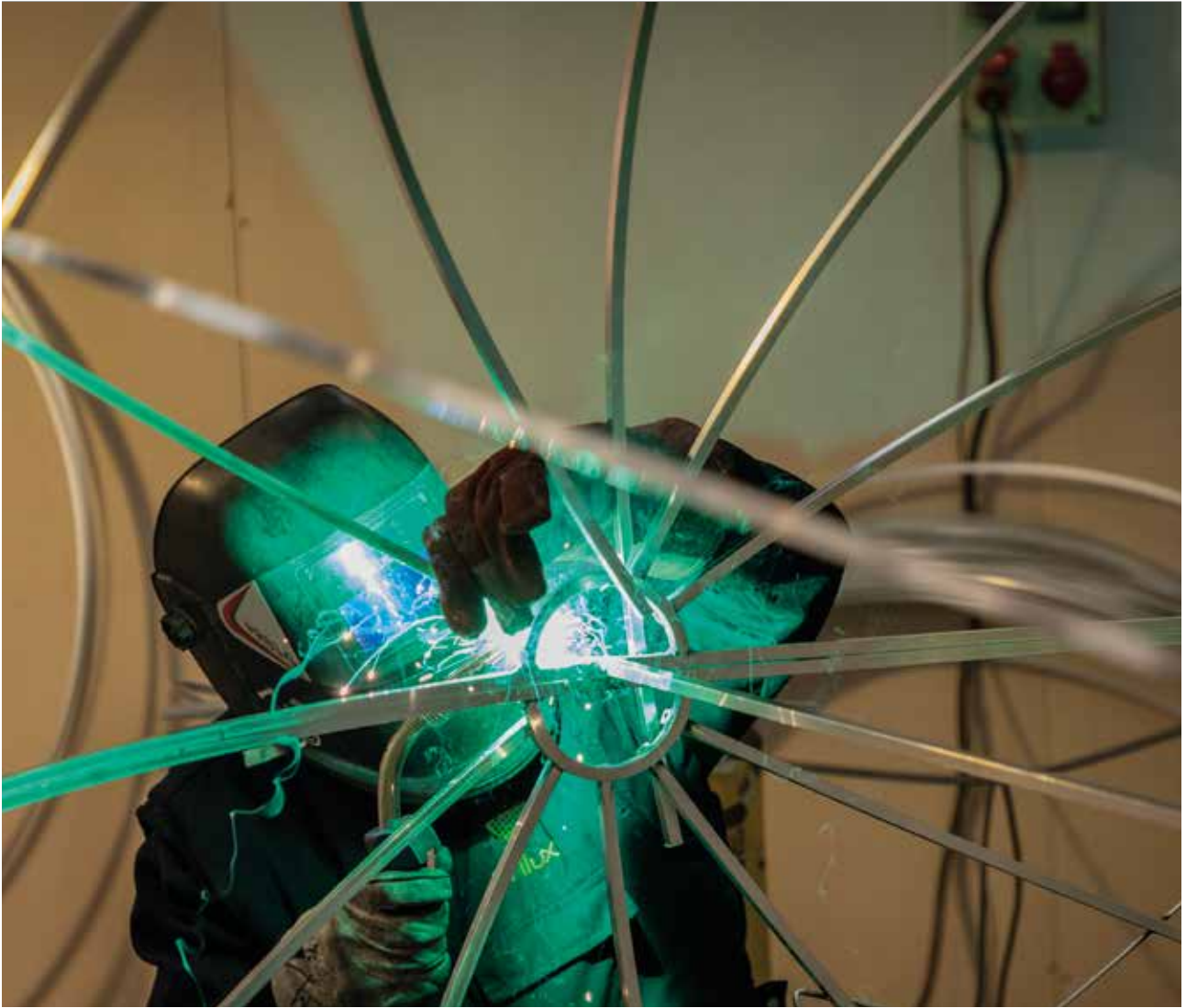

## F

Nous disposons d'une « salle blanche » équipée d'une ligne automatique de montage de composants SMD (sérigraphie - pick & place - four) où nous fabriquons tous nos modules LED destinés aux solutions d'éclairage « made in Spain ».

Prilux dispose d'un service qualité spécialisé aussi bien dans la qualité produit que dans le contrôle de la qualité intégrale de l'entreprise qui utilise l'outil AENOR CERTOOL pour la gestion de la qualité et l'amélioration continue de nos processus. Ce suivi permet de proposer un service répondant totalement aux spécifications attribuées.

Nous proposons des familles de produits certifiées ENEC, certification accordée par l'AENOR qui garantit la qualité et la sécurité des produits, aussi bien lors de l'ensemble du processus de fabrication que lors de leur mise sur le marché.

## P

Dispomos de uma “sala branca” equipada com uma linha automática de montagem de componentes SMD (Serigrafia – Pick & Place – Forno) onde fabricamos todos os nossos módulos LED destinados às soluções lumínicas “made in Spain”.

A Prilux possui um Departamento de Qualidade especializado tanto na Qualidade do Produto, como no controlo da Qualidade Total empresarial que utiliza a ferramenta AENOR CERTOOL para gestão da qualidade e melhoria contínua dos nossos processos. Este seguimento permite oferecer um serviço que cumpra as especificações atribuídas na sua totalidade.

Dispomos de famílias de produtos com certificado ENEC, concedido pela AENOR, que garante a qualidade e segurança dos produtos, tanto em todo o processo de fabrico como quando são introduzidos no mercado.

# Laboratorio

Laboratory

Laboratoire

Laboratório



Personalización  
Personalization  
Personnalisation  
Personalização



Goniofotómetro  
Goniophotometer  
Goniophotomètre  
Goniofotómetro



Ensayos IP / IK  
IP / IK Tests  
Essais IP / IK  
Ensaaios IP / IK



Esfera integradora  
Integrating sphere  
Sphère d'intégration  
Esfera integradora

## Ñ

Prilux dispone de laboratorio propio equipado con capacidad material y competencia técnica para realizar los ensayos de precertificación de luminarias según UNE-EN 60598 y fuentes de luz.

realizamos la caracterización de seguridad: durabilidad, calentamiento, IP, IK, dieléctricos...; eléctrica; fotométrica bajo EN 13032; espectral según CIE S-025 y TM30-15, con evaluación del cumplimiento de las directivas de protección del cielo; flicker según nueva regulación de ecodiseño; parámetros de Human Centric Lighting (HCL) y medidas para horticultura.

Para cubrir las demandas más exigentes llevamos a nuestras luminarias a situaciones extremas en términos de regulación, rangos de funcionamiento, altas temperaturas, congelación, conmutaciones y forzado de protecciones que se dan en situaciones reales.

Acompañamos al cliente en su necesidad de justificar el cumplimiento de los requisitos demandados por áreas de negocio o mercados como los árabes, industria alimentaria, HCL en el ámbito de educación, sanidad, geriatría, etc.

Llevamos a cabo las tareas de certificación con laboratorios y entidades acreditadas externas para conseguir los certificados de producto ENEC, CB, N, IAC, y asegurar el cumplimiento de los requisitos del CEI-IDAE vigentes.

## E

Prilux has its own laboratory equipped with the physical capability and technical competence to carry out pre-certification tests on luminaires under the UNE-EN 60598 standard and on light sources.

We perform characterisation of safety: endurance, thermal, ip, ik, dielectric...; electrical; photometric under EN 13032; spectral according to CIE S-025 and TM30-15, also evaluating compliance with directives on protection of the night sky; flicker according to new eco-design regulations; and human centric lighting (HCL) parameters and make measurements for horticulture.

To meet the most demanding requirements, we subject our luminaires to extreme conditions in terms of regulation, operating ranges, high temperatures, freezing, switching, and forcing of protections that occur in real situations. We work with our customers where they need to support compliance with requirements demanded by business sectors or markets, such as Arabian markets, the food industry, HCL in education, health care and geriatric fields, etc.

We conduct certification tasks with external laboratories and accredited entities to obtain ENEC, CB, N and Canary Islands Astrophysical Institute (IAC) product certificates and to ensure compliance with current Spanish Lighting Committee/Institute for Diversification and Saving of Energy (CEI-IDAE) requirements.



## F

Prilux dispose de son propre laboratoire doté de la capacité matérielle et de la compétence technique nécessaires pour procéder aux tests de pré-certification de luminaires selon la norme UNE-EN 60598 et sources lumineuses.

Nous réalisons la caractérisation de sécurité: endurance, chauffage, ip, ik, diélectriques... ; électrique ; photométrique selon la norme EN 13032 ; spectrale selon la norme CIE S-025 et TM30-15, avec évaluation de la conformité aux directives de protection du ciel ; flicker selon la nouvelle réglementation sur l'écoconception ; paramètres de human centric lighting (HCL) et prise de mesures pour l'horticulture.

Pour répondre aux demandes les plus exigeantes, nous soumettons nos luminaires à des situations extrêmes en termes de réglementation, fourchettes de fonctionnement, hautes températures, congélation, commutations et forçage de protections, comme dans les situations réelles. Nous accompagnons le client dans ses besoins de justification du respect des exigences posées par les différents domaines d'activité ou marchés, comme le marché arabe, l'industrie alimentaire, le HCL dans le domaine de l'éducation, la santé, la gériatrie, etc.

Nous nous livrons à des travaux de certification avec des laboratoires et établissements agréés externes pour obtenir les certificats de produits ENEC, CB, N, IAC et garantir le respect des exigences CEI-IDAE en vigueur.

## P

A Prilux dispõe de laboratório próprio equipado com capacidade material e competência técnica para realizar os ensaios de pré-certificação de luminárias segundo a UNE-EN 60598 e fontes de luz.

Realizamos a caracterização de segurança: resistência, aquecimento, ip, ik, dielétricos...; elétrica; fotométrica segundo a EN 13032; espectral segundo a CIE S-025 e TM30-15, com avaliação do cumprimento das diretivas de proteção do céu; flicker segundo a nova regulamentação de ecodesign; parâmetros de human centric lighting (HCL) e medidas para horticultura.

Para satisfazer as necessidades mais exigentes levamos as nossas luminárias a situações extremas em termos de regulação, faixas de funcionamento, altas temperaturas, congelamento, comutações e forçamento de proteções que ocorrem em situações reais. Acompanhamos o cliente na sua necessidade de comprovar o cumprimento dos requisitos exigidos por áreas de negócio ou mercados como os árabes, indústria alimentar, HCL no âmbito do ensino, saúde, geriatria, etc.

Realizamos as tarefas de certificação com laboratórios e entidades acreditadas externas para obter os certificados de produto ENEC, CB, N, IAC. e garantir o cumprimento dos requisitos do CEI-IDAE em vigor.

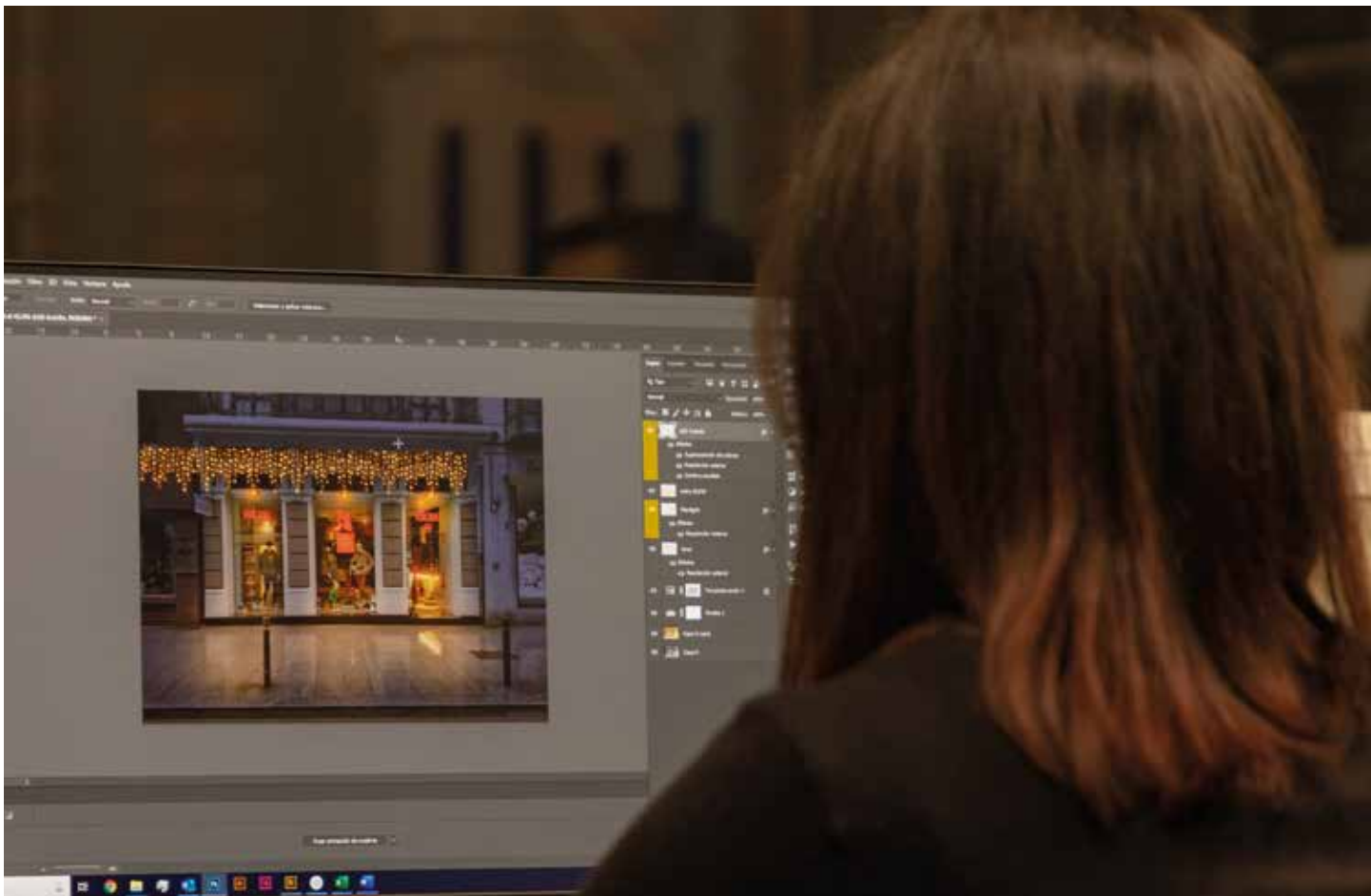

# Proyectos

## Projets / Projets / Projetos

### Ñ

Para las obras con mayores exigencias técnicas ponemos a disposición de nuestros clientes el departamento de proyectos, en el cual se estudian y diseñan soluciones lumínicas a través de software específico para ello.

Actualmente disponemos de soluciones tecnológicas de iluminación con sistemas de control integrados según demanda para la industria, oficinas, alumbrado público y vial, tiendas de retail, supermercados y centros comerciales, aplicaciones deportivas, parkings, hoteles, hospitales, colegios y universidades... Aportamos soluciones de iluminación creativas, personalizadas y adaptadas a las necesidades de nuestros clientes y ajustadas a la norma con un enfoque particular hacia el bienestar humano y la eficiencia energética.

### E

For projects of major technical demand we provide our clients with access to the projects' department, which studies and designs lighting solutions by means of software specifically tailored for this purpose.

At present we provide on-demand lighting technological solutions with integrated control systems for industrial facilities, offices, public and street lighting, retail stores, supermarkets and shopping centres, sport facilities, car parks, hotels, hospitals, schools and universities... We offer creative, customised lighting solutions adapted to the needs of our clients and in compliance with regulations, with a particular focus on human welfare and energy efficiency.





## F

Pour les travaux présentant des exigences techniques plus importantes, nous mettons à disposition de nos clients le département de projets, où les solutions d'éclairage sont étudiées et conçues grâce à un logiciel spécifique.

Nous disposons actuellement de solutions technologiques d'éclairage avec des systèmes de contrôle intégrés en fonction de la demande pour l'industrie, bureaux, l'éclairage public et routier, boutiques de vente au détail, supermarchés, centres commerciaux, applications sportives, parkings, hôtels, hôpitaux, écoles et universités... Nous fournissons des solutions d'éclairage créatives, personnalisées et adaptées aux besoins de nos clients, mais aussi conformes à la réglementation, avec une approche particulière focalisée sur le bien-être humain et l'efficacité énergétique.

## P

Para as obras com maiores exigências técnicas colocámos á disposição dos nossos clientes o nosso departamento de projectos, no qual se estudam e desenham soluções luminicas através de software específico para o efeito.

Actualmente dispomos de soluções tecnológicas de iluminação com sistemas de controlo integrados a pedido para a indústria, escritórios, iluminação pública e viária, lojas de retalho, supermercados e centros comerciais, aplicações desportivas, parques de estacionamento, hotéis, hospitais, escolas e universidades... Temos soluções de iluminação criativas, personalizadas e adaptadas às necessidades dos nossos clientes e ajustadas á norma com um foco particular no bem estar do ser humano e na eficiência energética.

# Hacemos realidad tus ideas

We makes your ideas come true

Nous réalisons vos idées

Nós tornamos suas ideias realidade



## Ideación de la campaña

Campaign brainstorming

Remue-méninges de la  
campagne

Brainstorming da  
campanha



## Fase comercial

Commercial step

Etape commerciale

Etapa comercial



## Proyectos

Projects

Projets

Projetos

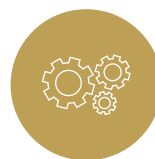

## Fabricación

Manufacturing

Fabrication

Fabricação

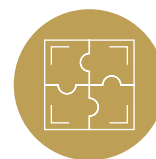

## Montaje

Mounting

Montage

Montagem

## Ñ

En **Prilux** diseñamos y producimos el 100% de los motivos en nuestras instalaciones de Toledo garantizando, su alta calidad y el cumplimiento de los plazos de entrega. Esto nos permite ofrecer la posibilidad, bajo pedido, de personalización de motivos adaptados totalmente a las necesidades y exigencias del cliente.

Nuestro departamento de Proyectos realiza simulaciones de decoraciones a partir de fotografías en las que se personalizan las decoraciones según las tendencias o directrices que nos marque el cliente. Proporcionamos asesoramiento, apoyo y orientación técnica adecuada para la obtención del mejor proyecto decorativo.

## E

In **Prilux** we design and manufacture 100% of the lighting motifs in our facilities in Toledo, ensuring not only high quality but also meeting the most challenging deadlines. We offer the possibility, on demand, of customizing and adapt the motif to any kind of demands and needs from the customer.

For this purpose, our Project Department carries out simulations of decorations from photographs in which, according to the last trends and client's guidelines, we customize all the motif. Moreover, we provide to our customers a good piece of advice, support and guidance to get the best decorative project.



## F

Chez **Prilux** nous concevons et produisons 100% des motifs dans nos installations de Tolède, en garantissant leur haute qualité et le respect des délais de livraison. Cela nous permet d'offrir la possibilité, sur demande, de personnaliser des motifs entièrement adaptés aux besoins et aux exigences du client.

Notre département Projets réalise des simulations de décorations à partir de photographies dans lesquelles les décorations sont personnalisées selon les tendances ou les directives fixées par le client. Nous fournissons des conseils, un soutien et des conseils techniques adéquats pour obtenir le meilleur projet décoratif.

## P

Na **Prilux** desenhamos e produzimos 100% dos motivos nas nossas instalações em Toledo, garantindo a sua elevada qualidade e cumprimento dos prazos de entrega. Isto permite-nos oferecer a possibilidade, a pedido, de personalizar motivos totalmente adaptados às necessidades e exigências do cliente.

O nosso departamento de Projetos realiza simulações de decorações a partir de fotografias em que as decorações são personalizadas de acordo com as tendências ou orientações definidas pelo cliente. Prestamos assessoria, apoio e orientação técnica adequada para obter o melhor projeto decorativo.







# Motivos

Motifs  
Motifs  
Motivos



# Colección Straight

---

Holly

Pine Forest

Tree

Reindeer Face

Reindeer Body

3D Tree

3D Cone

3D Pine Forest





MADE IN SPAIN  
Desing by PRILUX

# Holly

## Colección Straight



Motivo  
Motifs  
Motifs  
Motivos

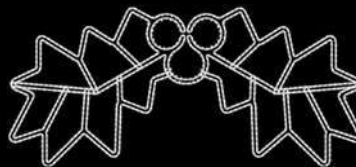

A

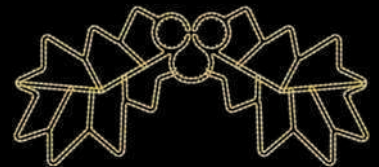

B



C



D

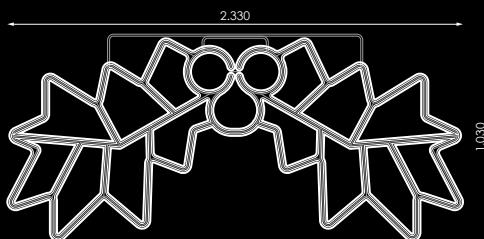

477192	A
477260	B

W							
86W	230V	CII	IP65 IP44 Plug	4kg	240x110x6cm	INC.	10mm

477338	C		STRING	PVC NET
477406	D		STRING	PVC NET

W							
108W	230V	CII	IP65 IP44 Plug	12kg	240x110x6cm	INC.	10mm

[GRÁFICOS: Unidades en mm/ GRAPHICS: Units in mm/ GRAPHIQUES: Unités en mm/ GRÁFICOS: Unidades em mm]

# Pine Forest

## Colección Straight



MADE IN SPAIN  
Desing by PRILUX

Motivo  
Motifs  
Motifs  
Motivos



A



B



C

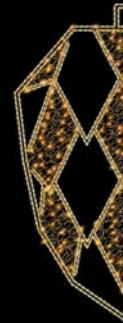

D



477178	A <b>flexiLED</b>
477246	B <b>flexiLED</b>

W							
52W	230V	CII	IP65 IP44 Plug	3,5kg	215x80x6cm	INC.	10mm

477314	C <b>flexiLED</b>	STRING <b>PLUS LED</b>	PVC NET
477383	D <b>flexiLED</b>	STRING <b>PLUS LED</b>	PVC NET

W							
63W	230V	CII	IP65 IP44 Plug	8kg	215x80x6cm	INC.	10mm

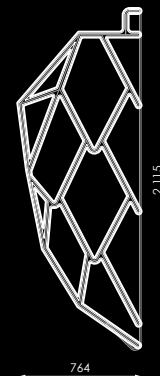





MADE IN SPAIN  
Desing by PRILUX









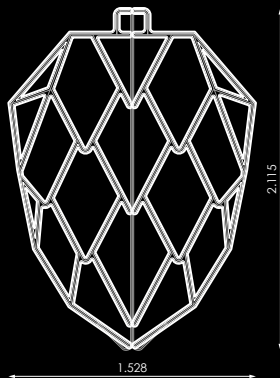
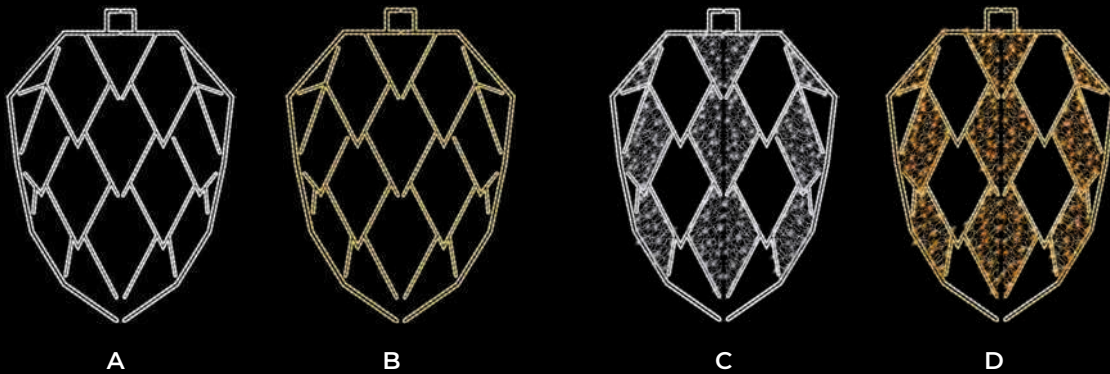
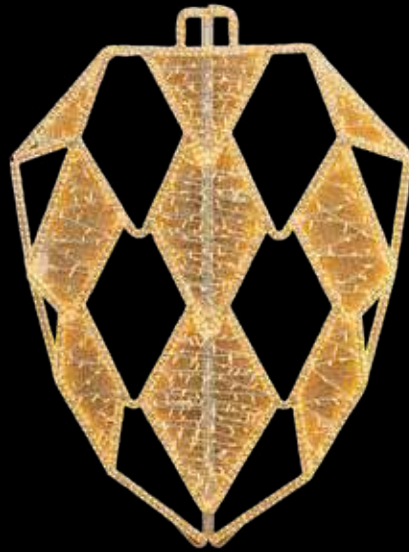





















# Pine Forest

## Colección Straight



**Motivo**  
 Motifs  
 Motifs  
 Motivos



							
477154	A						
477222	B						
							
86W	230V	CII	IP65 IP44 Plug	6kg	215x160x6cm	INC.	10mm
							
477291	C		STRING 	PVC NET 			
477369	D		STRING 	PVC NET 			
							
108W	230V	CII	IP65 IP44 Plug	12kg	215x160x6cm	INC.	10mm

[GRÁFICOS: Unidades en mm/ GRAPHICS: Units in mm/ GRAPHIQUES: Unités en mm/ GRÁFICOS: Unidades em mm]

# Tree

## Colección Straight

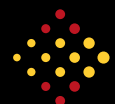

MADE IN SPAIN  
Desing by PRILUX

Motivo  
Motifs  
Motifs  
Motivos



A



B



C



D



477185	A <b>flexiLED</b>
477253	B <b>flexiLED</b>

38W	230V	CII	IP65 IP44 Plug	3,5kg	220x70x6cm	INC.	10mm

477321	C	<b>flexiLED</b>	STRING <b>PLUS LED</b> PVC NET
477390	D	<b>flexiLED</b>	STRING <b>PLUS LED</b> PVC NET

48W	230V	CII	IP65 IP44 Plug	5kg	220x70x6cm	INC.	10mm





MADE IN SPAIN  
Desing by PRILUX

# Tree

## Colección Straight

**Motivo**  
 Motifs  
 Motifs  
 Motivos

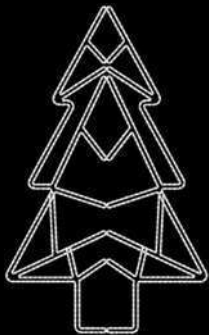

A



B



C



D

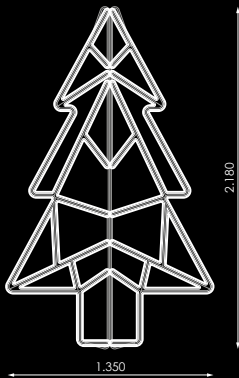

477161	A						
477239	B						
75W	230V	CII	IP65 IP44 Plug	5kg	220x140x6cm	INC.	10mm
477307	C		STRING	PVC NET			
477376	D		STRING	PVC NET			
95W	230V	CII	IP65 IP44 Plug	10kg	220x140x6cm	INC.	10mm

[GRÁFICOS: Unidades en mm/ GRAPHICS: Units in mm/ GRAPHIQUES: Unités en mm/ GRÁFICOS: Unidades em mm]

# Reindeer Body

## Colección Straight

Motivo  
Motifs  
Motifs  
Motivos



A



B



C



D



477888	A flexiLED
477895	B flexiLED

W							
74W	230V	CII	IP65 IP44 Plug	7,5kg	225x135x6cm	INC.	10mm

477901	C	flexiLED	STRING PLUS LED	PVC NET
477918	D	flexiLED	STRING PLUS LED	PVC NET

W							
84W	230V	CII	IP65 IP44 Plug	10kg	225x135x6cm	INC.	10mm

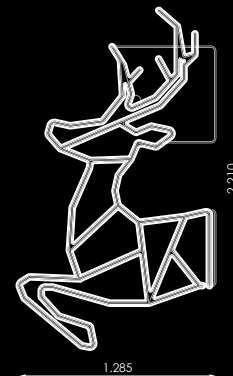





MADE IN SPAIN  
Desing by PRILUX

# Reindeer Body

## Colección Straight



**Motivo**  
 Motifs  
 Motifs  
 Motivos



A



B



C







D



2,000

2,577

	
477208	A
	
477277	B
	

							
99W	230V	CII	IP65 IP44 Plug	7,5kg	265x215x6cm	INC.	10mm

			
477345	C		STRING 
			PVC NET 
477413	D		STRING 
			PVC NET 

							
113W	230V	CII	IP65 IP44 Plug	11kg	265x215x6cm	INC.	10mm

[GRÁFICOS: Unidades en mm/ GRAPHICS: Units in mm/ GRAPHIQUES: Unités en mm/ GRÁFICOS: Unidades em mm]

# Reindeer Face

## Colección Straight

Motivo  
Motifs  
Motifs  
Motivos

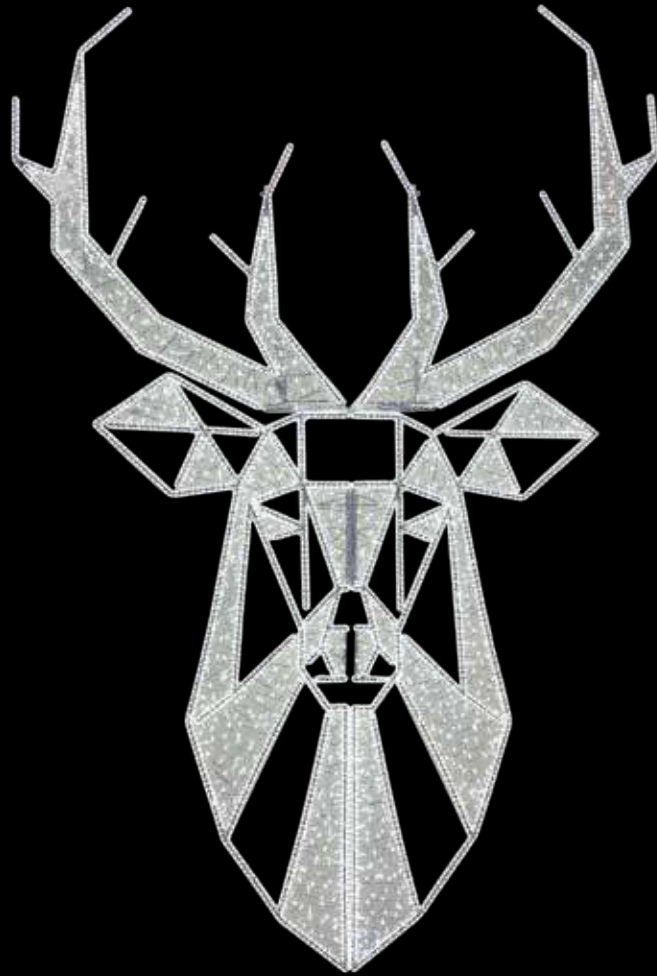

477147	A	flexiLED	
477215	B	flexiLED	

282W	230V	CII	IP65 IP44 Plug	32kg	2- 205x165x7,5cm 2- 305x133x7,5cm	INC.	25mm

477284	C	flexiLED	STRING PLUS LED	PVC NET
477352	D	flexiLED	STRING PLUS LED	PVC NET

338W	230V	CII	IP65 IP44 Plug	48kg	2- 205x165x7,5cm 2- 305x133x7,5cm	INC.	25mm

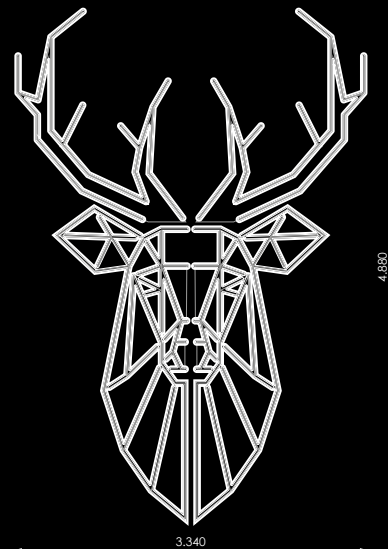

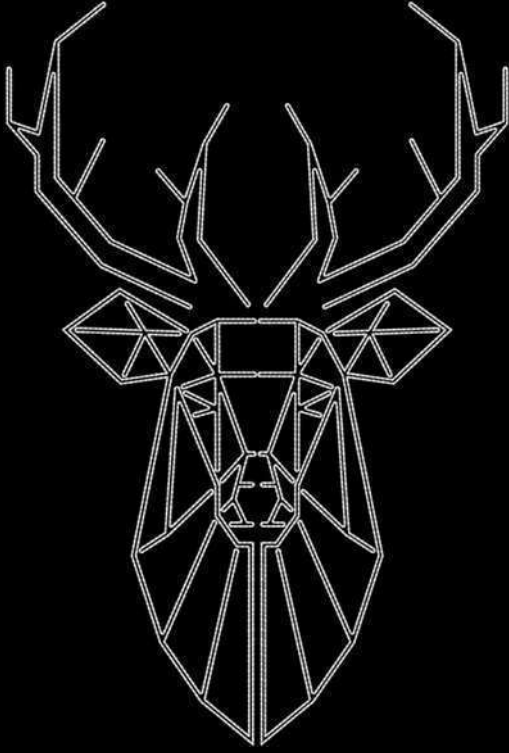

A

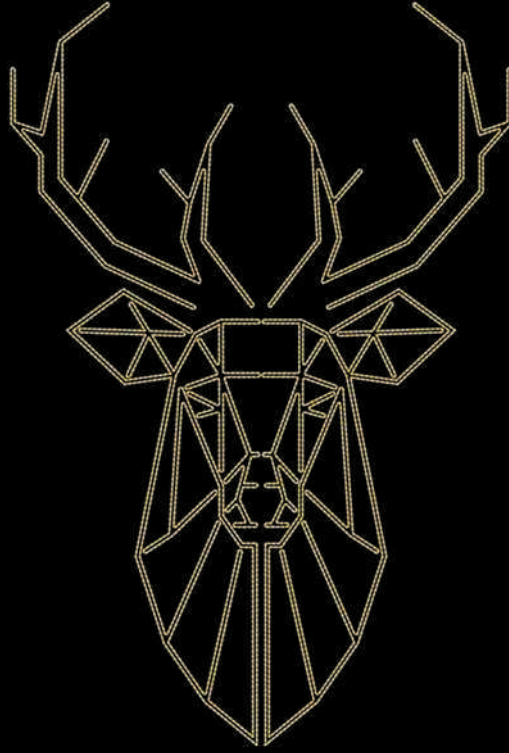

B

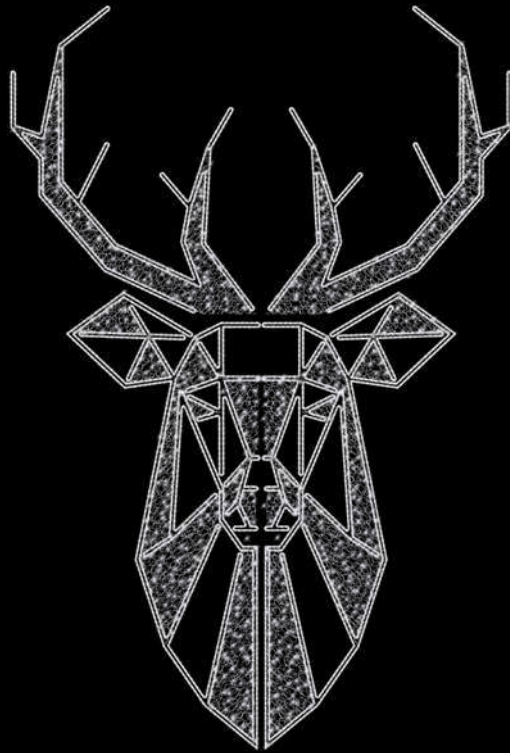

C

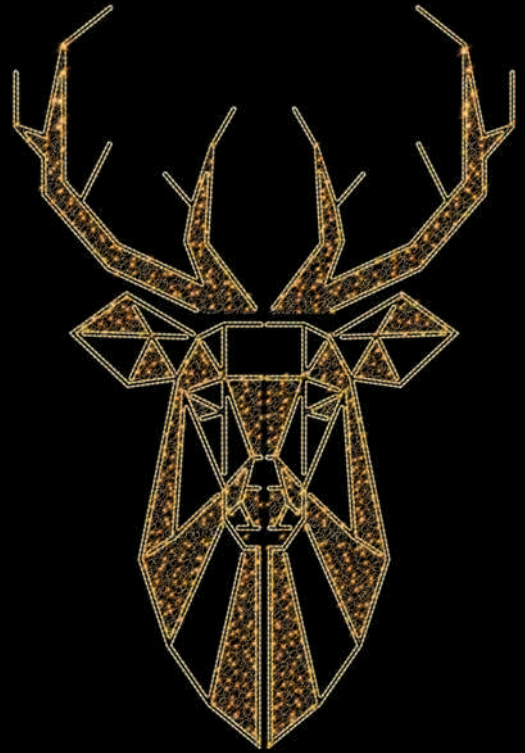

D









CC. Nervión Plaza  
Sevilla

# 3D Tree

## Colección Straight



MADE IN SPAIN  
Desing by PRILUX

Motivo  
Motifs  
Motifs  
Motivos

3D

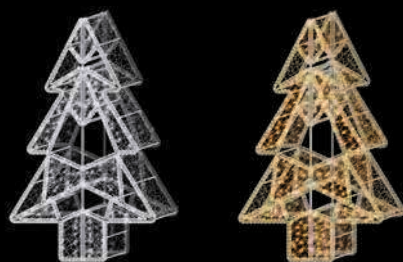

A

B



			1	2
509633	A	flexiLED	STRING PLUS LED	PVC NET
509664	B	flexiLED	STRING PLUS LED	PVC NET
W	⚡	⚡	⚡	⚡
115W	24V	CIII	IP65 IP44 Plug	23kg
				218x132x27cm
				INC. 10mm

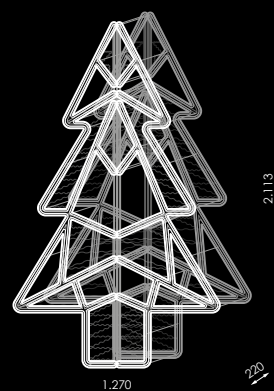

# 3D Cone

## Colección Straight



MADE IN SPAIN  
Desing by PRILUX

Motivo  
Motifs  
Motifs  
Motivos

3D

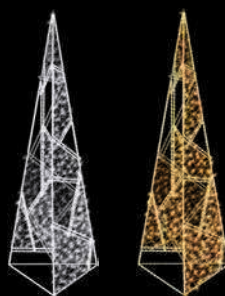

A

B



			1	2
509619	A	flexiLED	STRING PLUS LED	PVC NET
509640	B	flexiLED	STRING PLUS LED	PVC NET
W	⚡	⚡	⚡	⚡
60W	24V	CIII	IP65 IP44 Plug	14,5kg
				255x70x70cm
				INC. 10mm

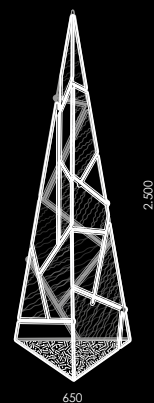





MADE IN SPAIN  
Desing by PRILUX

# 3D Pine Forest Colección Straight

3D Motivo  
Motifs  
Motifs  
Motivos

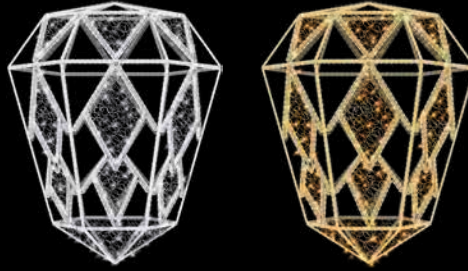

A

B

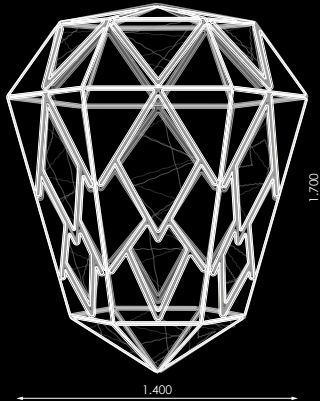

			1	2
509626	A	flexi LED	STRING PLUS LED	PVC NET
509657	B	flexi LED	STRING PLUS LED	PVC NET
W	⚡	□	⊙	⚖
304W	230V	CII	IP65 IP44 Plug	38kg
				175x145x145cm
				INC. 10mm



[GRÁFICOS: Unidades en mm/ GRAPHICS: Units in mm/ GRAPHIQUES: Unités en mm/ GRÁFICOS: Unidades em mm]

# Colección Toy

---

Cubes

Soldier

Doll

Train

Horse

3D Cubes

3D Soldier

3D Doll

3D Train

3D Horse





MADE IN SPAIN  
Desing by PRILUX

# Cubes

## Colección Toy



**Motivo**  
 Motifs  
 Motifs  
 Motivos



A



B

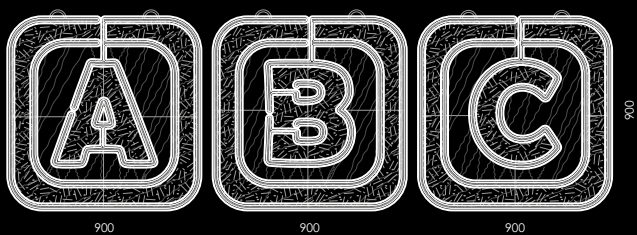

			1	2	3
509541	A	flexiLED	STRING PLUS LED LED	TAPIZ	PVC NET
509565	B	flexiLED	STRING PLUS LED LED	TAPIZ	PVC NET
W	⚡	□	⦿	⚖	📦
125W	230V	CII	IP65 IP44 Plug	21,5kg	(3x) 95x95x5cm
					INC. 10mm

[GRÁFICOS: Unidades en mm/ GRAPHICS: Units in mm/ GRAPHIQUES: Units in mm/ GRÁFICOS: Unidades em mm]

# Soldier

## Colección Toy



MADE IN SPAIN  
Desing by PRILUX

Motivo  
Motifs  
Motifs  
Motivos

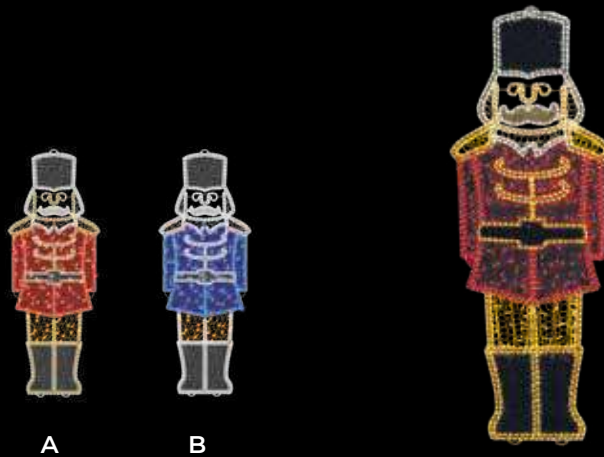

A B

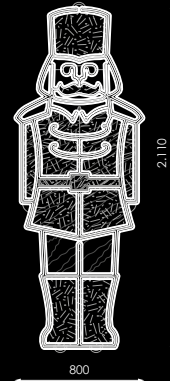

			1	2	3		
509435	A	flexi LED LED	STRING LED LED	TAPIZ	PVC NET		
509466	B	flexi LED	STRING LED LED	TAPIZ	PVC NET		
W	⚡	□	⊙	⚖	📦	🍷	📏
98W	230V	CII	IP65 IP44 Plug	10,5kg	216x85x5cm	INC.	10mm

# Doll

## Colección Toy



MADE IN SPAIN  
Desing by PRILUX

Motivo  
Motifs  
Motifs  
Motivos



A B

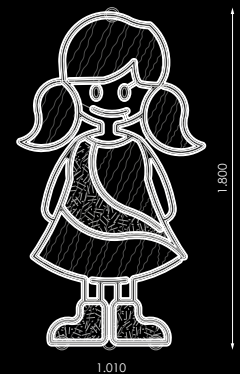

			1	2	3		
509589	A	flexi LED	STRING LED LED	TAPIZ	PVC NET		
509602	B	flexi LED	STRING LED LED	TAPIZ	PVC NET		
W	⚡	□	⊙	⚖	📦	🍷	📏
92W	230V	CII	IP65 IP44 Plug	9,5kg	185x106x5cm	INC.	10mm



MADE IN SPAIN  
Desing by PRILUX

# Train

## Colección Toy

Motivo  
 Motifs  
 Motifs  
 Motivos



A

B

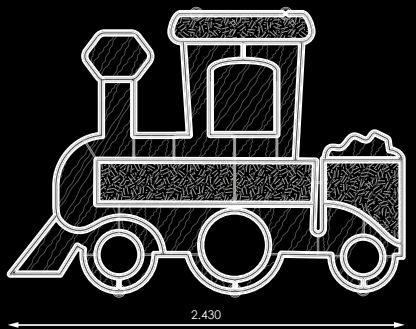

			1	2	3
509480	A	flexiLED	STRING	LED LED LED	TAPIZ PVC NET
509527	B	flexiLED	STRING	LED LED LED	TAPIZ PVC NET

W	⚡	□	⊙	Ⓚ	📦	🍷	📏
166W	230V	CII	IP65 IP44 Plug	18kg	248x178x5cm	INC.	10mm

[GRÁFICOS: Unidades en mm/ GRAPHICS: Units in mm/ GRAPHIQUES: Unités en mm/ GRÁFICOS: Unidades em mm]



MADE IN SPAIN  
Desing by PRILUX

# Horse

## Colección Toy

Motivo  
 Motifs  
 Motifs  
 Motivos



A

B

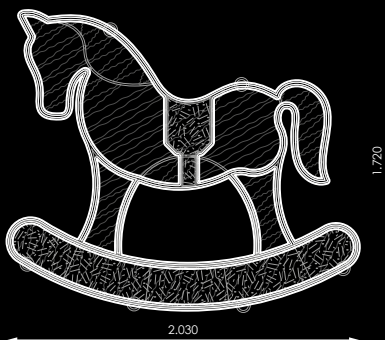

			1	2	3
509398	A	flexiLED	STRING	LED LED LED	TAPIZ PVC NET
509428	B	flexiLED	STRING	LED LED LED	TAPIZ PVC NET

W	⚡	□	⊙	Ⓚ	📦	🍷	📏
108W	230V	CII	IP65 IP44 Plug	13kg	208x177x5cm	INC.	10mm





CC. La Abadía  
Toledo



Gavá  
Barcelona





MADE IN SPAIN  
Desing by PRILUX

# 3D Cubes

## Colección Toy

3D Motivo  
Motifs  
Motifs  
Motivos



A



B

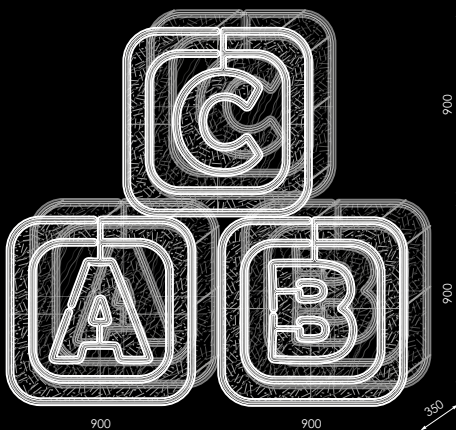

			1	2	3		
509534	A	flexiLED	STRING PLUS LED LED	TAPIZ	PVC NET		
509558	B	flexiLED	STRING PLUS LED LED	TAPIZ	PVC NET		
W	⚡	⚠	⊕	⚖	📦	🔌	📏
195W	24V	CIII	IP65 IP44 Plug	50,5kg	(3x) 95x95x40cm	INC.	10mm

[GRÁFICOS: Unidades en mm/ GRAPHICS: Units in mm/ GRAPHIQUES: Unités en mm/ GRÁFICOS: Unidades em mm]

# 3D Soldier

## Colección Toy



MADE IN SPAIN  
Desing by PRILUX

Motivo  
Motifs  
Motifs  
Motivos

3D



A



B

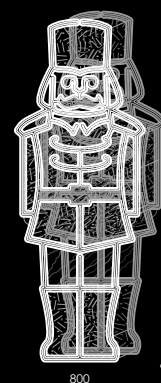

2.110

800

220

		1	2	3
509459	A	flexi LED LED	STRING LED LED	TAPIZ PVC NET
509442	B	flexi LED	STRING LED LED	TAPIZ PVC NET
W	⚡	⚡	⚡	⚡
110W	24V	CIII	IP65 IP44 Plug	23kg
				216x85x27cm
				INC.
				10mm

# 3D Doll

## Colección Toy



MADE IN SPAIN  
Desing by PRILUX

Motivo  
Motifs  
Motifs  
Motivos

3D



A



B

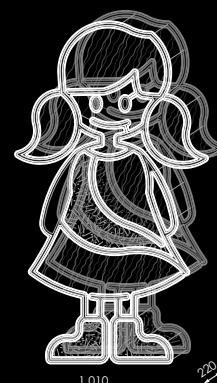

1.800

1.010

220

		1	2	3
509572	A	flexi LED	STRING LED LED	TAPIZ PVC NET
509596	B	flexi LED	STRING LED LED	TAPIZ PVC NET
W	⚡	⚡	⚡	⚡
110W	24V	CIII	IP65 IP44 Plug	21kg
				185x106x27cm
				INC.
				10mm



MADE IN SPAIN  
Desing by PRILUX

# 3D Train Colección Toy

3D Motivo  
Motifs  
Motifs  
Motivos



A

B

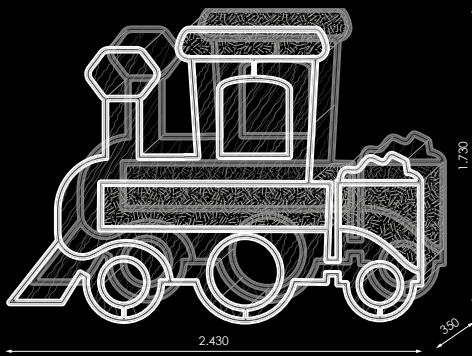

			1	2	3
509473	A	flexiLED	STRING	LED LED LED	TAPIZ PVC NET
509510	B	flexiLED	STRING	LED LED LED	TAPIZ PVC NET

W	⚡	⚠	⦿	⚖	📦	🍷	📏
230W	24V	CIII	IP65 IP44 Plug	37kg	248x178x40cm	INC.	10mm



MADE IN SPAIN  
Desing by PRILUX

# 3D Horse Colección Toy

3D Motivo  
Motifs  
Motifs  
Motivos



A

B

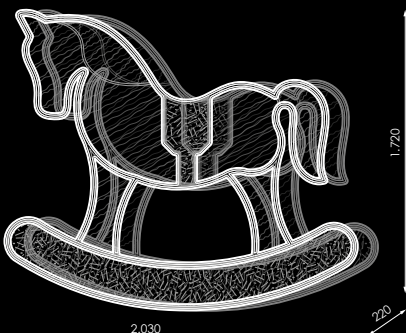

			1	2	3
509381	A	flexiLED	STRING	LED LED LED	TAPIZ PVC NET
509404	B	flexiLED	STRING	LED LED LED	TAPIZ PVC NET

W	⚡	⚠	⦿	⚖	📦	🍷	📏
150W	24V	CIII	IP65 IP44 Plug	30kg	208x177x27cm	INC.	10mm

[GRÁFICOS: Unidades en mm/ GRAPHICS: Units in mm/ GRAPHIQUES: Unités en mm/ GRÁFICOS: Unidades em mm]

# Colección Curly

---

Bird

Star

Ball

Small Butterfly

Ball 3D

Cone 3D

Hoop 3D

Hoop 3D Screenshot

Medusa

Papyre







MADE IN SPAIN  
Desing by PRILUX

# Bird

## Colección Curly



A



B



C



2.792

1.594

			W
480338	A	flexiLED	130W
480383	B	flexiLED	130W
478694	C	flexiLED	184W
230V	CII	IP65 IP44 Plug	11kg
			160x300x6cm
			INC.
			10mm

[GRÁFICOS: Unidades en mm/ GRAPHICS: Units in mm/ GRAPHIQUES: Unités en mm/ GRÁFICOS: Unidades em mm]

# Star

## Colección Curly



MADE IN SPAIN  
Desing by PRILUX

Motivo  
Motifs  
Motifs  
Motivos

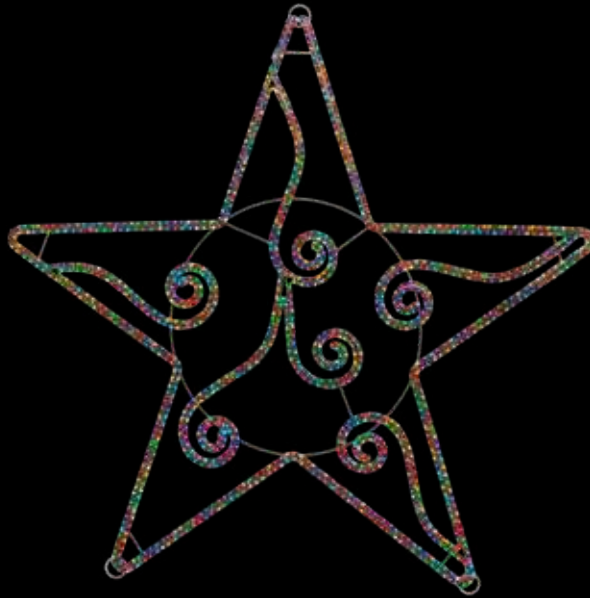

A



B



C



Barcode	Model	LED Type	Power (W)
480345	A	flexi LED	100W
480390	B	flexi LED	100W
478700	C	flexi LED	142,6W

230V	CII	IP65 IP44 Plug	8kg	210x210x6cm	INC.	10mm





MADE IN SPAIN  
Desing by PRILUX

# Ball

## Colección Curly

**Motivo**  
 Motifs  
 Motifs  
 Motivos

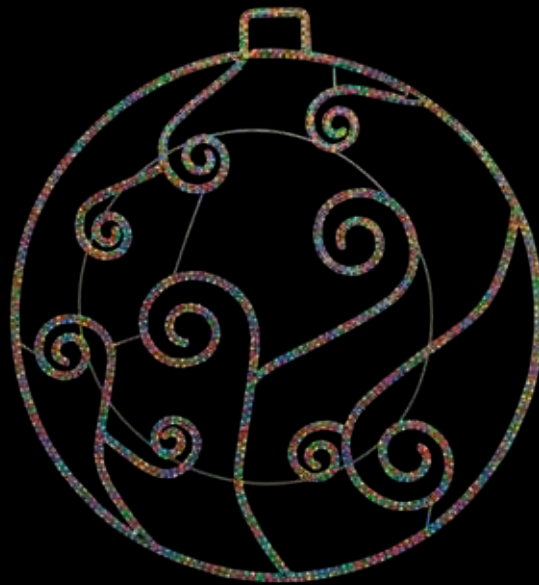

A



B



C

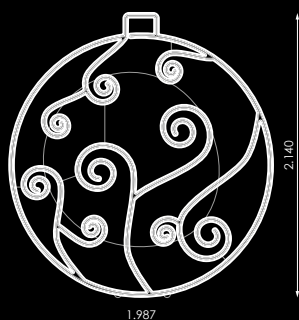

			W
480352	A	flexiLED	130W
480406	B	flexiLED	130W
478717	C	flexiLED	184W

230V	CII	IP65 IP44 Plug	11kg	220x205x6cm	INC.	10mm

[GRÁFICOS: Unidades en mm/ GRAPHICS: Units in mm/ GRAPHIQUES: Unités en mm/ GRÁFICOS: Unidades en mm]

# Small Butterfly

## Colección Curly



MADE IN SPAIN  
Desing by PRILUX

Motivo  
Motifs  
Motifs  
Motivos



A



B



C



			W
480321	A	flexi LED	105W
480376	B	flexi LED	105W
478687	C	flexi LED	151,8W

230V	CII	IP65 IP44 Plug	9kg	190x160x6cm	INC.	10mm





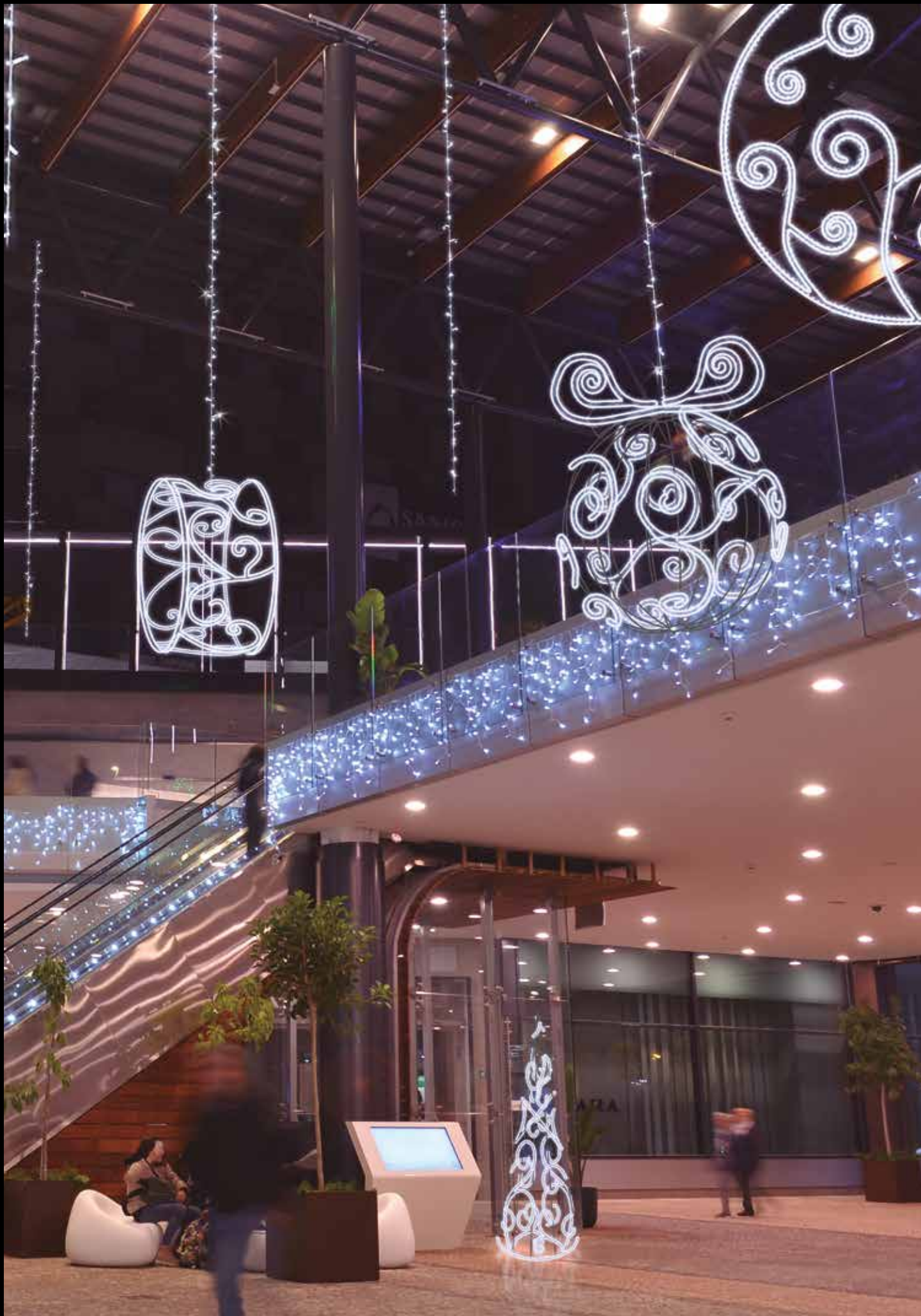

# Ball 3D

## Colección Curly



MADE IN SPAIN  
Desing by PRILUX

Motivo  
Motifs  
Motifs  
Motivos

3D



A



B



C



						W
509701	A	flexiLED				219W
509749	B	flexiLED				219W
512084	C	flexiLED				336W
230V	CII	IP65 IP44 Plug	20,5kg	(2x) 135x135x70cm (1x) 129x58x7cm	INC.	10mm

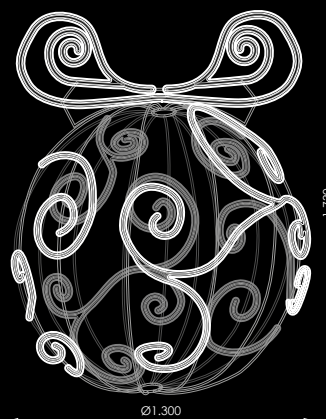



MADE IN SPAIN  
Desing by PRILUX

# Cone 3D

## Colección Curly

3D

Motivo  
Motifs  
Motifs  
Motivos

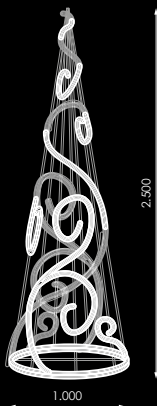
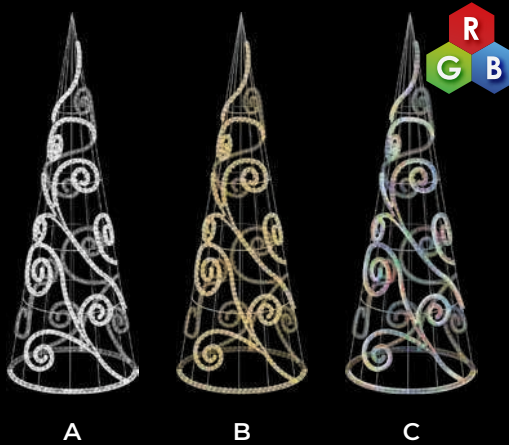

Barcode	Model	LED Type	Power (W)	Voltage
509671	A	flexiLED	100W	24V
509718	B	flexiLED	100W	24V
512053	C	flexiLED	317W	230V

CI	IP65 IP44 Plug	19kg	255x105x105cm	INC.	10mm
----	-------------------	------	---------------	------	------

[GRÁFICOS: Unidades en mm/ GRAPHICS: Units in mm/ GRAPHIQUES: Unités en mm/ GRÁFICOS: Unidades em mm]



# Hoop 3D

## Colección Curly



MADE IN SPAIN  
Desing by PRILUX

Motivo  
Motifs  
Motifs  
Motivos

3D

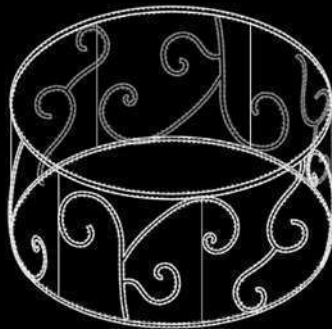

A



B



C



			W
509688	A	flexi LED	162W
509725	B	flexi LED	162W
512060	C	flexi LED	248W

230V	CII	IP65 IP44 Plug	21kg	130x130x65cm	INC.	10mm

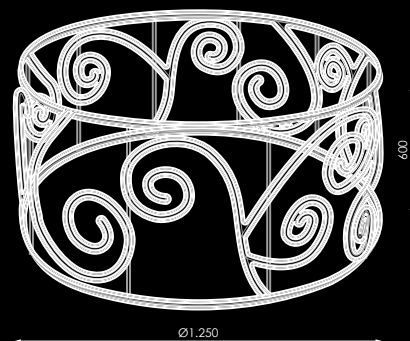





MADE IN SPAIN  
Desing by PRILUX

# Hoop 3D Screenlight

## Colección Curly

3D Motivo  
Motifs  
Motifs  
Motivos

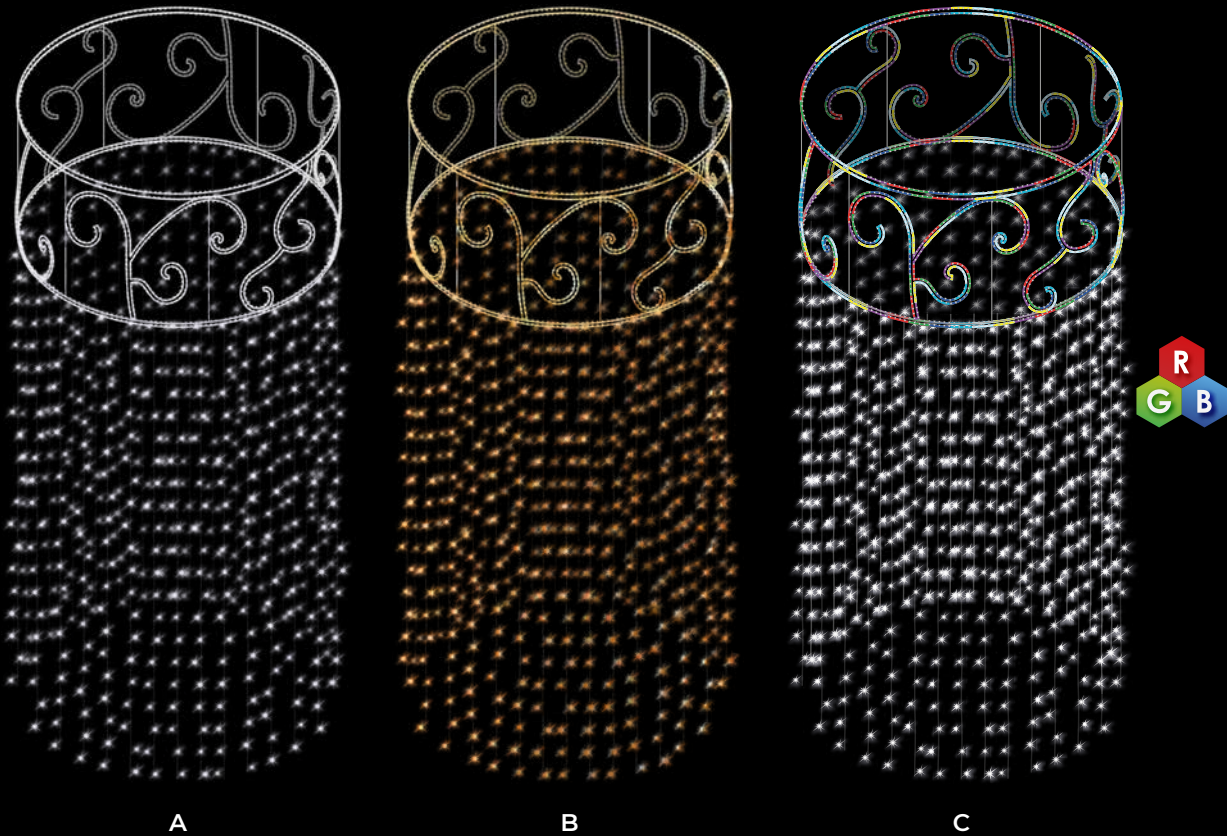

[GRÁFICOS: Unidades en mm/ GRAPHICS: Units in mm/ GRAPHIQUES: Unités en mm/ GRÁFICOS: Unidades em mm]



				W
509695	A	flexi LED	SCREENLIGHT LED	204W
509732	B	flexi LED	SCREENLIGHT LED	204W
512077	C	flexi LED	SCREENLIGHT LED	290W
⚡	□	⊙	⚖	📦
230V	CII	IP65 IP44 Plug	21,5kg	130x130x65cm INC. 10mm

# Medusa

## Colección Curly



MADE IN SPAIN  
Desing by PRILUX

Motivo  
Motifs  
Motifs  
Motivos

3D



A



B



C



				W
446662	A	flexiLED	4	328W
446679	B	flexiLED	4	328W
510622	C	flexiLED	4	448W

230V	CII	IP65 IP44 Plug	30kg	(2x) 236x115x5cm (1x) 30x30x30cm	INC.	

				W
446709	A	flexiLED	8	656W
446716	B	flexiLED	8	656W
510653	C	flexiLED	8	853W

230V	CII	IP65 IP44 Plug	48kg	(4x) 236x115x9cm (1x) 30x30x30cm	INC.	

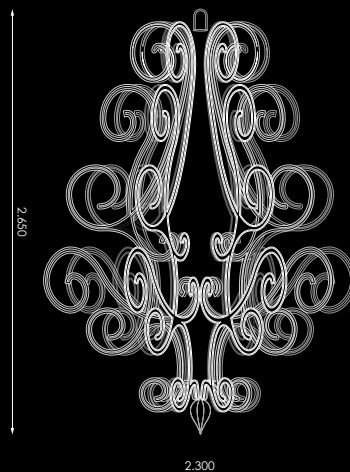



MADE IN SPAIN  
Desing by PRILUX

# Papyre

## Colección Curly

3D Motivo  
Motifs  
Motifs  
Motivos

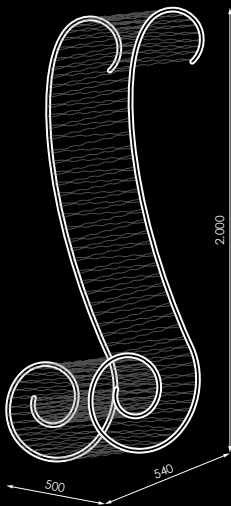

446099	flexiLED	STRING PLUS LED				
446105	flexiLED	STRING PLUS LED				
W						
44W	230V	CII	IP65 IP44 Plug	7kg	200x54x50cm	INC.

[GRÁFICOS: Unidades en mm/ GRAPHICS: Units in mm/ GRAPHIQUES: Unités en mm/ GRÁFICOS: Unidades em mm]

# Colección Fantasy

---

Big Ball

Small Ball

Big Star

Small Star

Big Star 3D

Small Star 3D

Naida





MADE IN SPAIN  
Desing by PRILUX

# Big Ball

## Colección Fantasy

**Motivo**  
 Motifs  
 Motifs  
 Motivos

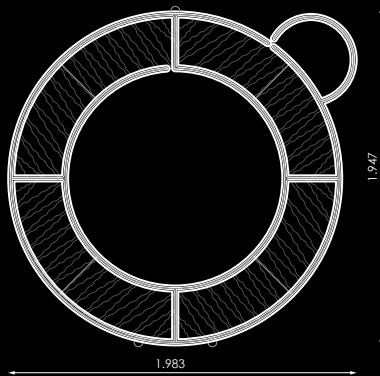

			1	2	W
479332	A	flexiLED	STRING PLUS LED	PVC NET	108W
479370	B	flexiLED	STRING PLUS LED	PVC NET	108W
479417	C	flexiLED	STRING PLUS LED	PVC NET	150W

230V	CII	IP65 IP44 Plug	16kg	200x200x6cm	INC.	10mm



MADE IN SPAIN  
Desing by PRILUX

# Small Ball

## Colección Fantasy

**Motivo**  
 Motifs  
 Motifs  
 Motivos

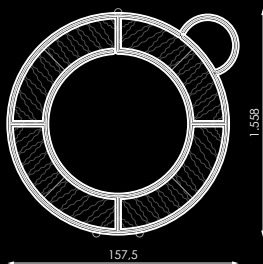

			1	2	W
479349	A	flexiLED	STRING PLUS LED	PVC NET	84W
479387	B	flexiLED	STRING PLUS LED	PVC NET	84W
479424	C	flexiLED	STRING PLUS LED	PVC NET	117W

230V	CII	IP65 IP44 Plug	11kg	160x160x6cm	INC.	10mm

[GRÁFICOS: Unidades en mm/ GRAPHICS: Units in mm/ GRAPHIQUES: Unités en mm/ GRÁFICOS: Unidades en mm]

# Big Star

## Colección Fantasy



MADE IN SPAIN  
Desing by PRILUX

Motivo  
Motifs  
Motifs  
Motivos

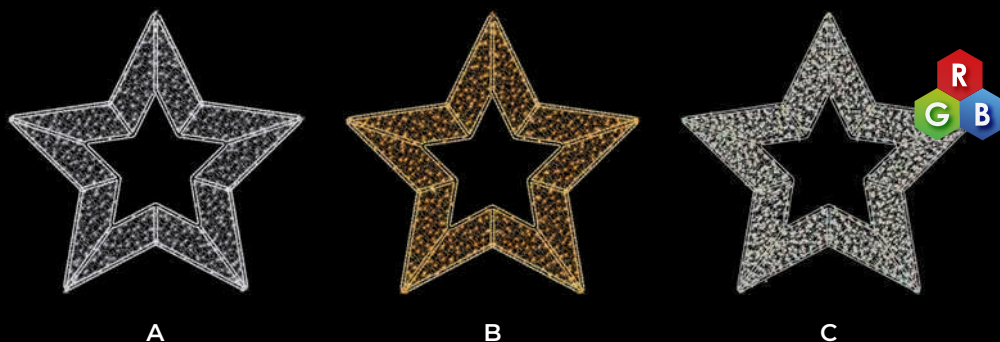

A

B

C



		1	2	W
479356	A	flexi LED	STRING PLUS LED	PVC NET 148W
479394	B	flexi LED	STRING PLUS LED	PVC NET 148W
479431	C	flexi LED	STRING PLUS LED	PVC NET 206W

230V	CII	IP65 IP44 Plug	21kg	260x260x6cm	INC.	10mm

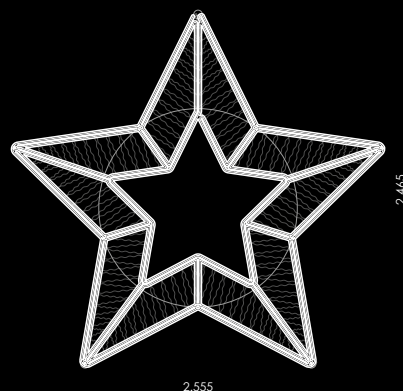

# Small Star

## Colección Fantasy



MADE IN SPAIN  
Desing by PRILUX

Motivo  
Motifs  
Motifs  
Motivos

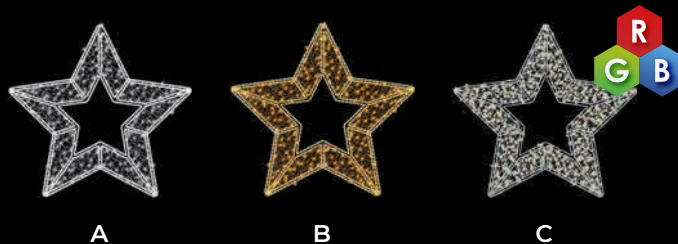

A

B

C



		1	2	W
479363	A	flexi LED	STRING PLUS LED	PVC NET 82W
479400	B	flexi LED	STRING PLUS LED	PVC NET 82W
479448	C	flexi LED	STRING PLUS LED	PVC NET 118W

230V	CII	IP65 IP44 Plug	11kg	170x170x6cm	INC.	10mm



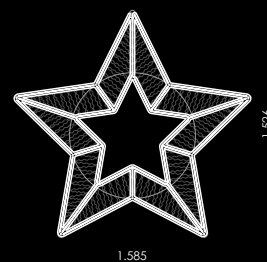

MADE IN SPAIN  
Desing by PRILUX

# Naida

## Colección Fantasy

3D Motivo  
Motifs  
Motifs  
Motivos

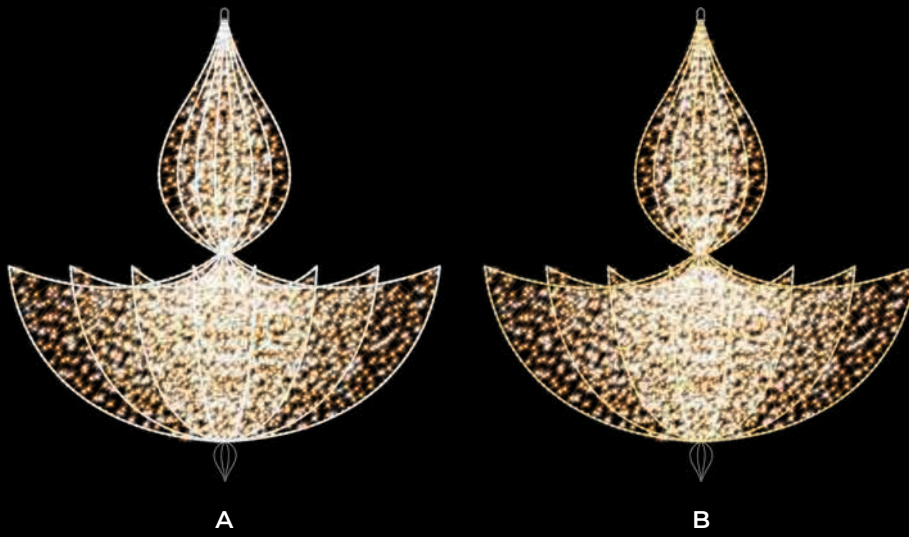

[GRÁFICOS: Unidades en mm/ GRAPHICS: Units in mm/ GRAPHIQUES: Unités en mm/ GRÁFICOS: Unidades em mm]

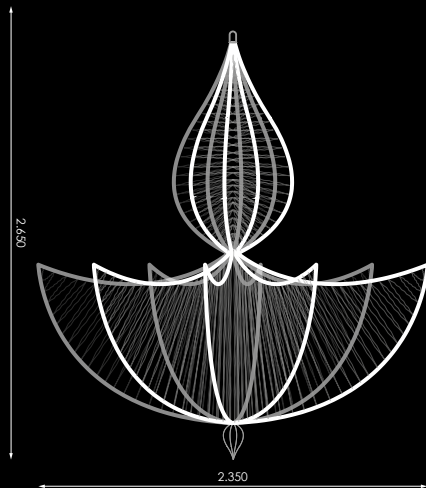

	446600	A	flexiLED STRING PLUS LED			
	446617	B	flexiLED STRING PLUS LED			
W						
230W	230V	CII	IP65 IP44 Plug	40kg	(5x) 270x120x5cm (1x) 30x30x30cm	INC.

# Small Star 3D

## Colección Fantasy



MADE IN SPAIN  
Desing by PRILUX

Motivo  
Motifs  
Motifs  
Motivos

3D



A



B



C



D



			1	2
565059	A	flexiLED	STRING PLUS LED	PVC NET
565073	B	flexiLED	STRING PLUS LED	PVC NET

W	⚡	□	⊙	⚖	📦	🔌	📏
176W	230V	CII	IP65 IP44 Plug	34kg	170x170x25cm	INC.	10mm

563727	C	flexiLED	STRING PLUS LED	
565066	D	flexiLED	STRING PLUS LED	

W	⚡	□	⊙	⚖	📦	🔌	📏
176W	230V	CII	IP65 IP44 Plug	31kg	170x170x25cm	INC.	10mm

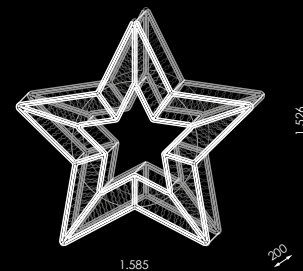





MADE IN SPAIN  
Desing by PRILUX

# Big Star 3D

## Colección Fantasy

3D Motivo  
Motifs  
Motifs  
Motivos

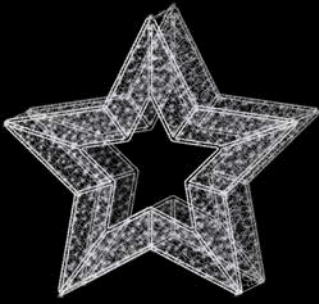

A



B



C



D



[GRÁFICOS: Unidades en mm/ GRAPHICS: Units in mm/ GRAPHIQUES: Unités en mm/ GRÁFICOS: Unidades em mm]

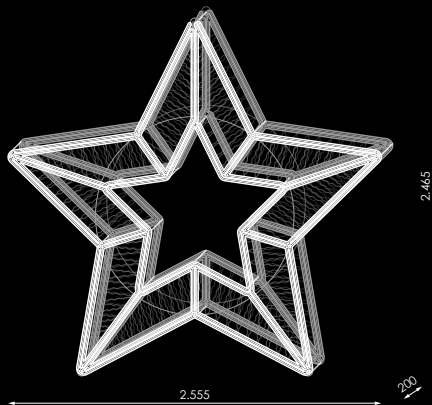

			1	2			
565028	A	flexiLED	STRING PLUS LED	PVC NET			
565042	B	flexiLED	STRING PLUS LED	PVC NET			
563659	C	flexiLED	STRING PLUS LED				
565035	D	flexiLED	STRING PLUS LED				
W	⚡	□	⊙	⚖	📦	🔌	📏
290W	230V	CI	IP65 IP44 Plug	60kg	260x260x25cm	INC.	10mm
W	⚡	□	⊙	⚖	📦	🔌	📏
290W	230V	CI	IP65 IP44 Plug	56kg	260x260x25cm	INC.	10mm

# Colección Edén

---

Okra

Silene

Nepenthes



MADE IN SPAIN  
Desing by PRILUX

# Okra

## Colección Edén

Motivo  
Motifs  
Motifs  
Motivos



A

B

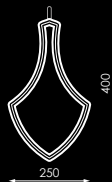

544498	A	flexi LED LED					
544504	B	flexi LED LED					
W	⚡	□	⊙	⚖	📦	🔌	📏
6W	230V	CII	IP65 IP44 Plug	1kg	43x30x5cm	INC.	10mm



MADE IN SPAIN  
Desing by PRILUX

# Silene

## Colección Edén

Motivo  
Motifs  
Motifs  
Motivos



A

B

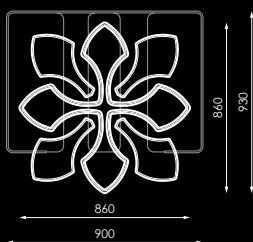

544436	A	flexi LED LED					
544443	B	flexi LED LED					
W	⚡	□	⊙	⚖	📦	🔌	📏
36W	230V	CII	IP65 IP44 Plug	3kg	97x95x5cm	INC.	10mm

[GRÁFICOS: Unidades en mm/ GRAPHICS: Units in mm/ GRAPHIQUES: Unités en mm/ GRÁFICOS: Unidades en mm]









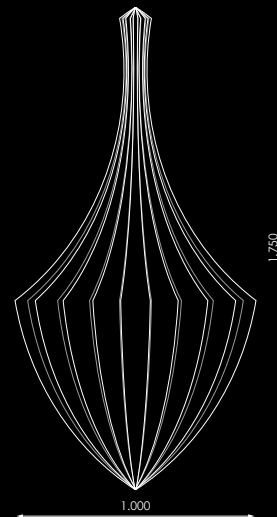
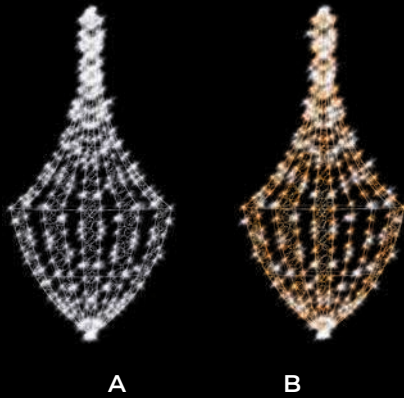
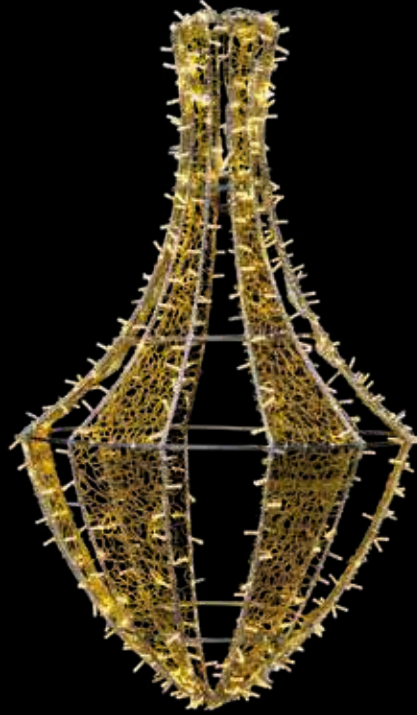





# Nepenthes

## Colección Edén

Motivo  
Motifs  
Motifs  
Motivos

3D



						
544832	A	STRING <b>PLUS</b>  	PVC NET 			
544849	B	STRING <b>PLUS</b>  	PVC NET 			
<b>W</b>						
32W	230V	CII	IP65 IP44 Plug	10kg	(2x) 180x55x55cm	INC.

Bajo pedido / On request / Sur commande / A pedido



IP20





# Colección Helix

---

Abolone

Cingula

Mitra

Bolma

Obba





MADE IN SPAIN  
Desing by PRILUX

# Abolone

## Colección Helix

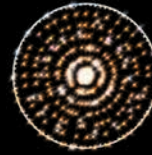
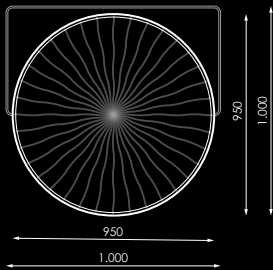

A

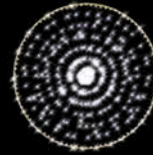

B



544993	A	flexiLED	STRING PLUS
545006	B	flexiLED	STRING PLUS
W			
25W	230V	CII	IP65 IP44 Plug
3,5kg	105x105x5cm	INC.	10mm

[GRÁFICOS: Unidades en mm/ GRAPHICS: Units in mm/ GRAPHIQUES: Unités en mm/ GRÁFICOS: Unidades en mm]



MADE IN SPAIN  
Desing by PRILUX

# Cingula

## Colección Helix

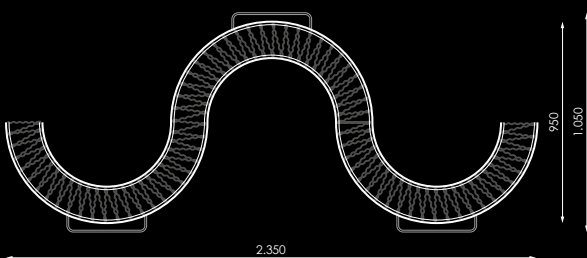

A



B



545211	A	flexiLED	STRING PLUS
545228	B	flexiLED	STRING PLUS
W			
44W	230V	CII	IP65 IP44 Plug
6,5kg	240x110x5cm	INC.	10mm



Gualdalupe  
Cáceres



Gualdalupe  
Cáceres





MADE IN SPAIN  
Desing by PRILUX

# Mitra

## Colección Helix

**Motivo**  
 Motifs  
 Motifs  
 Motivos

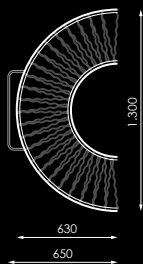
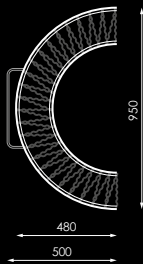

95cm							
Icon	Code	Label	Technology	Power	Voltage	Weight	Dimensions
	544870	A	flexi LED	17W	230V	2kg	100x55x5cm
	544887	B	flexi LED	17W	230V	2kg	100x55x5cm
	544894	C	flexi LED	17W	230V	2kg	100x55x5cm
	544900	D	flexi LED	17W	230V	2kg	100x55x5cm

130cm							
Icon	Code	Label	Technology	Power	Voltage	Weight	Dimensions
	544931	E	flexi LED	28W	230V	4kg	135x70x5cm
	544948	F	flexi LED	28W	230V	4kg	135x70x5cm
	544955	G	flexi LED	28W	230V	4kg	135x70x5cm
	544962	H	flexi LED	28W	230V	4kg	135x70x5cm

[GRÁFICOS: Unidades en mm/ GRÁFICOS: Units in mm/GRAPHICS: Units in mm/GRÁFICOS: Units en mm/GRÁFICOS: Unidades em mm]

# Bolma

## Colección Helix

Motivo  
Motifs  
Motifs  
Motivos

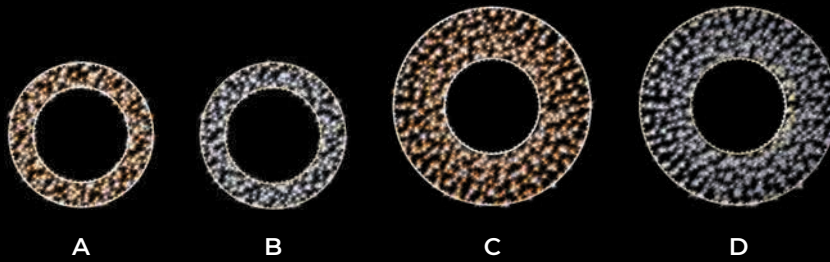

95cm							
545099	A	flexi LED	STRING PLUS				
545105	B	flexi LED	STRING PLUS				
W							
30W	230V	CII	IP65 IP44 Plug	3kg	105x110x5cm	INC.	10mm

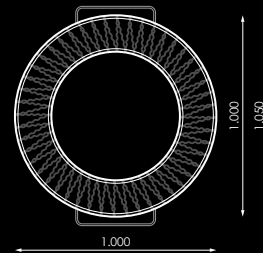

130cm							
545150	C	flexi LED	STRING PLUS				
545167	D	flexi LED	STRING PLUS				
W							
49W	230V	CII	IP65 IP44 Plug	6kg	135x140x5cm	INC.	10mm

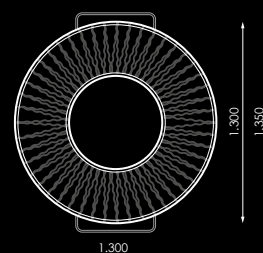



MADE IN SPAIN  
Desing by PRILUX

# Obba

## Colección Helix

3D Motivo  
Motifs  
Motifs  
Motivos

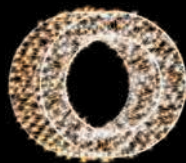
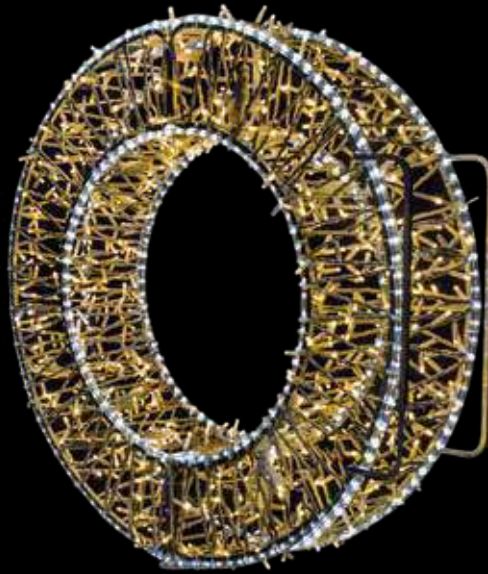

A

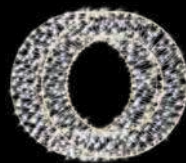

B

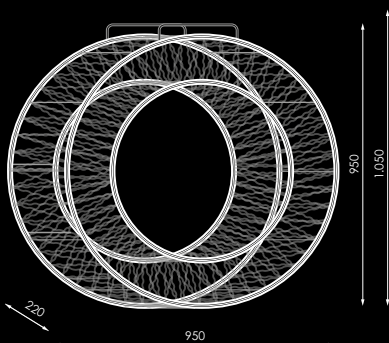

			95cm			
545273	A	flexiLED	STRING PLUS			
545280	B	flexiLED	STRING PLUS			
W						
92W	230V	CII	IP65 IP44 Plug	10kg	110x100x27cm	INC. 10mm

[GRÁFICOS: Unidades en mm/ GRAPHICS: Units in mm/ GRAPHIQUES: Unités en mm/ GRÁFICOS: Unidades em mm]

# Felices Fiestas

Corporeo



MADE IN SPAIN  
Desing by PRILUX



200cm						
Barcode	LED	Color	W	V	Class	IP
546201	LED	Gold	9W	230V	CII	IP44
546218	LED	Red	9W	230V	CII	IP44
W	V	Class	IP	kg	Dimensions	INC.
9W	230V	CII	IP44	4kg	205x45x8cm	INC.



400cm						
Barcode	LED	Color	W	V	Class	IP
546225	LED	Gold	15W	230V	CII	IP44
546232	LED	Red	15W	230V	CII	IP44
W	V	Class	IP	kg	Dimensions	INC.
15W	230V	CII	IP44	8kg	210x70x14cm	INC.



## Información / Information / Information / Informações

Ñ/ Ideal para fachadas. Iluminación solo por la parte frontal.

E/ Ideal for facades. Lighting only from the front.

F/ Idéal pour les façades. Éclairage seulement de l'avant.

P/ Ideal para fachadas. Iluminação apenas pela frente.





MADE IN SPAIN  
Desing by PRILUX

Feliz Navidad  
Corporeo



2,000



4,000



200cm						
546140						
546157						
W						
9W	230V	CII	IP44	4kg	205x45x8cm	INC.

400cm						
546164						
546171						
W						
15W	230V	CII	IP44	8kg	243x75x14cm	INC.

Información / Information / Information / Informações

Ñ/ Ideal para fachadas. Iluminación solo por la parte frontal.

E/ Ideal for facades. Lighting only from the front.

F/ Idéal pour les façades. Éclairage seulement de l'avant.

P/ Ideal para fachadas. Iluminação apenas pela frente.

[GRÁFICOS: Unidades en mm/ GRÁFICOS: Units in mm/ GRAPHIQUES: Unités en mm/ GRÁFICOS: Unidades em mm]

Prilux te propone ser creativo.

Para ello se han diseñado una serie de motivos que te permiten combinar con otros motivos de nuestro catálogo. Fíjate en el símbolo que te indica con qué motivo puedes combinarlo, y..... CREA!!!

## EJEMPLOS DE COMPOSICIÓN

COMPOSITION EXAMPLE/EXEMPLES DE COMPOSITION/EXEMPLOS DE COMPOSIÇÃO



Prilux proposes you to be creative. To do this, a series of motifs have been designed that allow you to combine with other motifs in our catalog. Look at the symbol that tells you why you can combine it, and.....CREATE !!!

Prilux vous propose d'être créatif. Pour ce faire, une série de motifs a été conçue pour vous permettre de combiner avec d'autres motifs de notre catalogue. Regardez le symbole qui vous indique pourquoi vous pouvez le combiner, et.....CREATE !!!

Prilux propõe que você seja criativo. Para fazer isso, uma série de motivos foram projetados para combinar com outros motivos em nosso catálogo. Olhe para o símbolo que lhe diz porque você pode combiná-lo e.....CRIAR !!!



MADE IN SPAIN  
Desing by PRILUX

# Feliz Navidad

**Motivo**  
 Motifs  
 Motifs  
 Motivos

A *Feliz Navidad*

C *Feliz Navidad*

B *Feliz Navidad*

D *Feliz Navidad*



			W	
545372	A	<b>flexi</b>	78W	17kg
545389	B	<b>flexi</b>	78W	17kg
489072	C	<b>flexi</b> DOUBLE NEON	234W	19kg
489089	D	<b>flexi</b> DOUBLE NEON	234W	19kg

230V	CII	IP65 IP44 Plug	300x74x7,5cm	INC.	10mm



MADE IN SPAIN  
Desing by PRILUX

# Feliz Navidad

## Abetos

**Motivo**  
 Motifs  
 Motifs  
 Motivos

A *Feliz Navidad*

B *Feliz Navidad*



			W	
509848	A	<b>flexi</b>	TAPIZ	
509855	B	<b>flexi</b>	TAPIZ	

132W	230V	CII	IP65 IP44 Plug	16kg	10mm

(2x) 97x77x5cm  
 (2x) 30x32x5cm  
 (1x) 51x53x5cm  
 (1x) 99x33x5cm  
 (1x) 305x557x5cm

[GRÁFICOS: Unidades en mm/ GRAPHICS: Units in mm/ GRAPHIQUES: Unités en mm/ GRÁFICOS: Unidades en mm]



# Feliz Navidad

8m



MADE IN SPAIN  
Desing by PRILUX



Motivo  
Motifs  
Motifs  
Motivos

Ávila

A *Feliz Navidad*

B *Feliz Navidad*



509800	A flexiLED						
509817	B flexiLED						
W							
267W	230V	CII	IP65 IP44 Plug	30kg	350x165x20cm	INC.	20mm

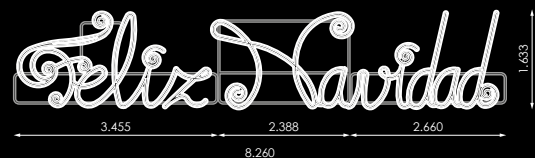





MADE IN SPAIN  
Desing by PRILUX

# Feliz Navidad

6m



Motivo  
Motifs  
Motifs  
Motivos



[GRÁFICOS: Unidades en mm/ GRAPHICS: Units in mm/ GRAPHIQUES: Unités en mm/ GRÁFICOS: Unidades en mm]



	1	2	
567152	flexi DOUBLE NEON	flexi	STRING PLUS
W			
750,5W	230V	CL	IP65 IP44 Plug
27kg	300x200x20cm	INC.	10x20mm

# Felices Fiestas



MADE IN SPAIN  
Desing by PRILUX

Motivo  
Motifs  
Motifs  
Motivos



545334	A	flexi	LED				
545341	B	flexi	LED				
W	⚡	□	⦿	⚖	📦	🔌	📏
48W	230V	CII	IP65 IP44 Plug	7kg	270x55x5cm	INC.	10mm



				W	⚖
545358	A	flexi	LED	96W	24kg
545365	B	flexi	LED	96W	24kg
489096	C	flexi	DOUBLE NEON LED	288W	26kg
489102	D	flexi	DOUBLE NEON LED	288W	26kg
⚡	□	⦿	📦	🔌	📏
230V	CII	IP65 IP44 Plug	275x95x7,5cm	INC.	10mm

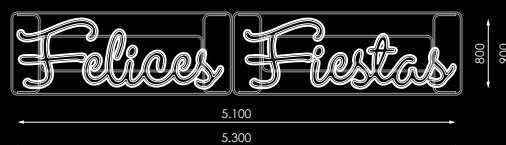



MADE IN SPAIN  
Desing by PRILUX

# Felices Fiestas

## Estrellas 6m



Motivo  
Motifs  
Motifs  
Motivos



567169	flexi DOUBLE NEON	STRING PLUS
W		
368W	230V	CII
IP65 IP44 Plug	38kg	300x220x20cm
INC.	10x20mm	

[GRÁFICOS: Unidades en mm/ GRAPHICS: Units in mm/ GRAPHIQUES: Unités en mm/ GRÁFICOS: Unidades en mm]



# Felices Fiestas

con Estrella de Mar

Motivo  
Motifs  
Motifs  
Motivos



	1	2	T
149358	A	flexiLED	FLASH BULB
149372	B	flexiLED	FLASH BULB
W	⚡	⏏	⚖
73W	230V	CII	IP65 IP44 Plug
		8kg	270x83x5cm
			INC. 10mm



	1	2	T
149365	A	flexiLED	FLASH BULB
149389	B	flexiLED	FLASH BULB
W	⚡	⏏	⚖
120W	230V	CII	IP65 IP44 Plug
		26kg	275x173x7,5cm
			INC. 25mm

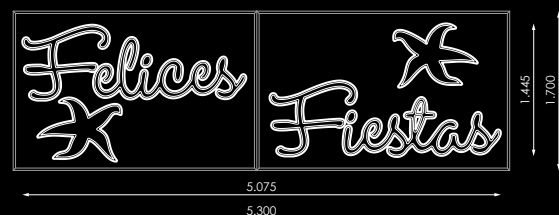





MADE IN SPAIN  
Desing by PRILUX

# Felices Fiestas con Estrellas y Bolas



**Motivo**  
 Motifs  
 Motifs  
 Motivos



[GRÁFICOS: Unidades en mm/ GRAPHICS: Units in mm/ GRAPHIQUES: Unités en mm/ GRÁFICOS: Unidades em mm]



149396	<b>flexiLED</b>	CHRISTMAS BALL					
<b>W</b>							
57W	230V	CII	IP65 IP44 Plug	8kg	270x84x5cm	INC.	10mm



149402	<b>flexiLED</b>	CHRISTMAS BALL					
<b>W</b>							
116W	230V	CII	IP65 IP44 Plug	23kg	275x150x7,5cm	INC.	25mm

# Felices Fiestas

## con Cometa



MADE IN SPAIN  
Desing by PRILUX

Motivo  
Motifs  
Motifs  
Motivos



Moralzarzal  
Madrid



	1	2					
149426	flexiLED	flexiLED					
W							
78W	230V	CII	IP65 IP44 Plug	8kg	270x84x5cm	INC.	10mm



	1	2					
149419	flexiLED	flexiLED					
W							
156W	230V	CII	IP65 IP44 Plug	26kg	275x173x7,5cm	INC.	25mm

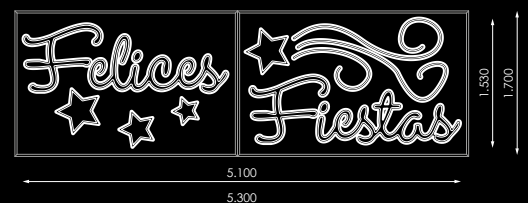



MADE IN SPAIN  
Desing by PRILUX

# Felices Fiestas

## Rama

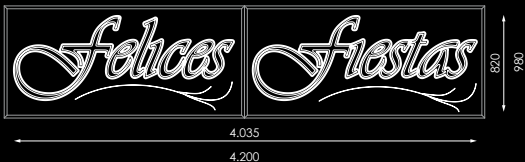

		1	2
149488	A	flexiLED	flexiLED
149471	B	flexiLED	flexiLED

W	⚡	□	⊙	⚖	📦	🔌	📏
66W	230V	CII	IP65 IP44 Plug	4kg	258x63x5cm	INC.	10mm

		1	2
149501	A	flexiLED	flexiLED
149495	B	flexiLED	flexiLED

W	⚡	□	⊙	⚖	📦	🔌	📏
120W	230V	CII	IP65 IP44 Plug	18kg	220x100x7,5cm	INC.	25mm

[GRÁFICOS: Unidades en mm/ GRAPHICS: Units in mm/ GRAPHIQUES: Unités en mm/ GRÁFICOS: Unidades em mm]

# Felices Fiestas

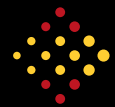

MADE IN SPAIN  
Desing by PRILUX

Motivo  
Motifs  
Motifs  
Motivos



A *Felices Fiestas*

B *Felices Fiestas*

385046	A						
094863	B						
40W	230V	CII	IP65 IP44 Plug	4kg	209x40x5cm	INC.	10mm



385053	A						
094788	B						
56W	230V	CII	IP65 IP44 Plug	8kg	313x58x5cm	INC.	25mm















MADE IN SPAIN  
Desing by PRILUX







# Bones Festes con Cometa



**Motivo**  
 Motifs  
 Motifs  
 Motivos



	1	2					
385695	flexiLED	flexiLED					
W							
78W	230V	CII	IP65 IP44 Plug	8kg	270x84x5cm	INC.	10mm

	1	2					
385701	flexiLED	flexiLED					
W							
156W	230V	CII	IP65 IP44 Plug	26kg	264x173x7,5cm	INC.	25mm

[GRÁFICOS: Unidades en mm/ GRAPHICS: Units in mm/ GRAPHIQUES: Unités en mm/ GRÁFICOS: Unidades en mm]

# Bones Festes

## Rama



MADE IN SPAIN  
Desing by PRILUX

Motivo  
Motifs  
Motifs  
Motivos



		1	2
385657	A	flexi LED	flexi LED
385664	B	flexi LED	flexi LED

W	⚡	⏏	⦿	⚖	📦	🍷	📏
62W	230V	CII	IP65 IP44 Plug	7kg	260x63x5cm	INC.	10mm



		1	2
385671	A	flexi LED	flexi LED
385688	B	flexi LED	flexi LED

W	⚡	⏏	⦿	⚖	📦	🍷	📏
100W	230V	CII	IP65 IP44 Plug	18kg	220x100x7,5cm	INC.	25mm



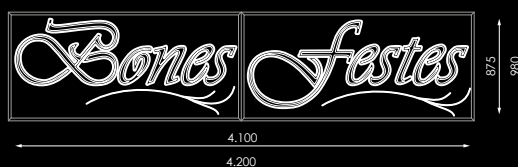

MADE IN SPAIN  
Desing by PRILUX

# Bones Festes

## Freestyle



A *BONES FESTES*

B *BONES FESTES*



	385084	A	
	954273	B	
<b>W</b>			
66W	230V	CII	IP65 IP44 Plug
		4kg	270x50x5cm
			INC.
			10mm
	373821	A	
	954280	B	
<b>W</b>			
90W	230V	CII	IP65 IP44 Plug
		14,5kg	213x70x7,5cm
			INC.
			25mm

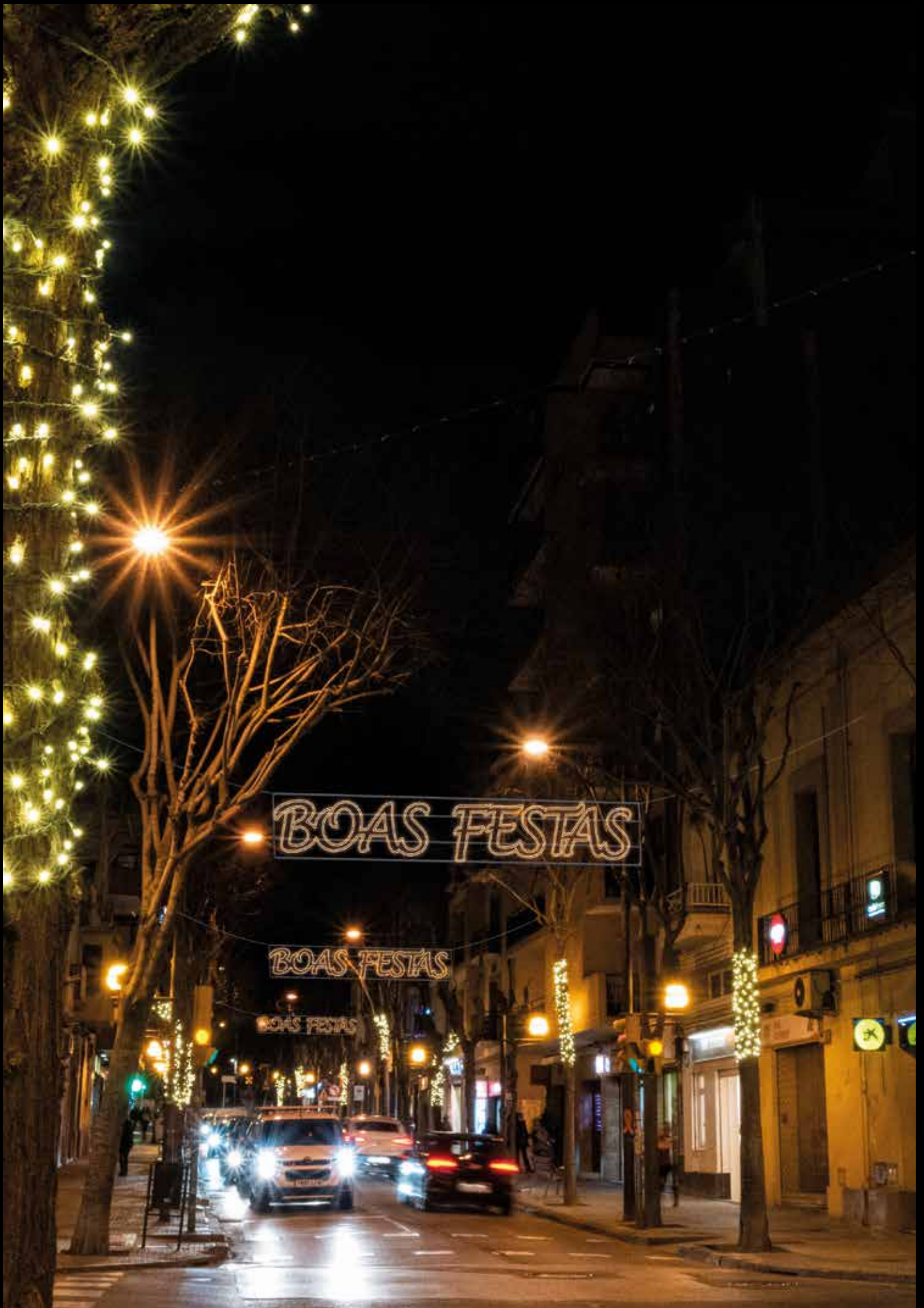





MADE IN SPAIN  
Desing by PRILUX

# Boas Festas

## Freestyle



A BOAS FESTAS  
B BOAS FESTAS



385077	A flexi LED						
961578	B flexi LED						
W							
81W	230V	CII	IP65 IP44 Plug	13,5kg	235x70x7,5cm	INC.	25mm



MADE IN SPAIN  
Desing by PRILUX

# Boas Festas

## 6m



A BOAS FESTAS  
B BOAS FESTAS



567176	A flexi DOUBLE NEON LED						
567183	B flexi DOUBLE NEON LED						
W							
477W	230V	CII	IP65 IP44 Plug	30kg	390x130x7,5cm	INC.	10x20mm

[GRÁFICOS: Unidades en mm/ GRAPHICS: Units in mm/ GRAPHIQUES: Unités en mm/ GRÁFICOS: Unidades em mm]

# Zorionak

## Rama



MADE IN SPAIN  
Desing by PRILUX

Motivo  
Motifs  
Motifs  
Motivos



		1	2
385732	A	flexiLED	flexiLED
385749	B	flexiLED	flexiLED

W	⚡	□	⊙	⚖	📦	🔌	📏
67W	230V	CII	IP65 IP44 Plug	10kg	293x100x5cm	INC.	10mm





MADE IN SPAIN  
Desing by PRILUX



[GRÁFICOS: Unidades en mm/ GRAPHICS: Units in mm/ GRAPHIQUES: Unités en mm/ GRÁFICOS: Unidades em mm]

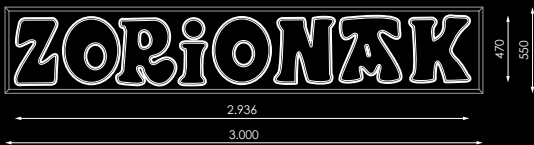

			W	kg
389556	A	flexi LED	47,5W	10kg
193313	B	flexi LED	47,5W	10kg
489119	C	flexi DOUBLE NEON LED	144W	18kg
489126	D	flexi DOUBLE NEON LED	144W	18kg

⚡	□	⊙	📦	🔌	📏
230V	CII	IP65 IP44 Plug	303x57x5cm	INC.	25mm

544276	A	flexi LED		
544269	B	flexi LED		

W	⚡	□	⊙	kg	📦	🔌	📏
90W	230V	CII	IP65 IP44 Plug	16kg	300x95x7,5cm	INC.	25mm

# Merry Christmas



MADE IN SPAIN  
Desing by PRILUX

Motivo  
Motifs  
Motifs  
Motivos

A Merry Christmas

B Merry Christmas



545396	A	flexiLED	
545402	B	flexiLED	
W	⚡	□	⊙
60W	230V	CII	IP65 IP44 Plug
		10kg	200x70x7,5cm
			INC. 10mm



# Merry Christmas



MADE IN SPAIN  
Desing by PRILUX

Motivo  
Motifs  
Motifs  
Motivos

A Merry Christmas

B Merry Christmas



509862	A	flexiLED	
509879	B	flexiLED	
W	⚡	□	⊙
111W	230V	CII	IP65 IP44 Plug
		14,5kg	256x115x10cm
			INC. 10mm







MADE IN SPAIN  
Desing by PRILUX

# Bonnes Fêtes con Cometa

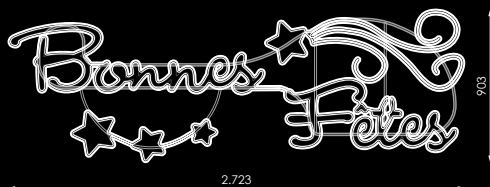

	1	2					
494885	flexiLED	flexiLED					
W							
81W	230V	CII	IP65 IP44 Plug	8,5kg	277x907x7,5cm	INC.	10mm

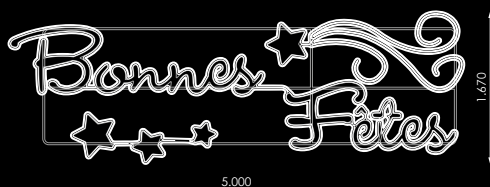

	1	2					
526159	flexiLED	flexiLED					
W							
165W	230V	CII	IP65 IP44 Plug	26kg	264x173x7,5cm	INC.	10x20mm

[GRÁFICOS: Unidades en mm/ GRAPHICS: Units in mm/ GRAPHIQUES: Unités en mm/ GRÁFICOS: Unidades em mm]

# Bonne Année

## Rama



MADE IN SPAIN  
Desing by PRILUX

Motivo  
Motifs  
Motifs  
Motivos



Bonne Année



		1	2
526166		flexiLED	flexiLED
W	⚡	□	○
69W	230V	CII	IP65 IP44 Plug
		7,5kg	256x63x5cm
			INC.
			20x10mm



		1	2
528047		flexiLED	flexiLED
W	⚡	□	○
102W	230V	CII	IP65 IP44 Plug
		12kg	266x95x10cm
			INC.
			20x10mm





MADE IN SPAIN  
Desing by PRILUX

# Joyeux Noël



🏠  
Motivo  
Motifs  
Motifs  
Motivos

[GRÁFICOS: Unidades en mm/ GRAPHICS: Units in mm/ GRAFIQUES: Unités en mm/ GRÁFICOS: Unidades em mm]

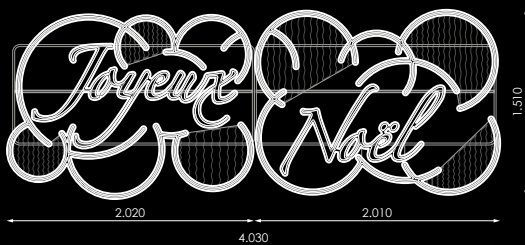
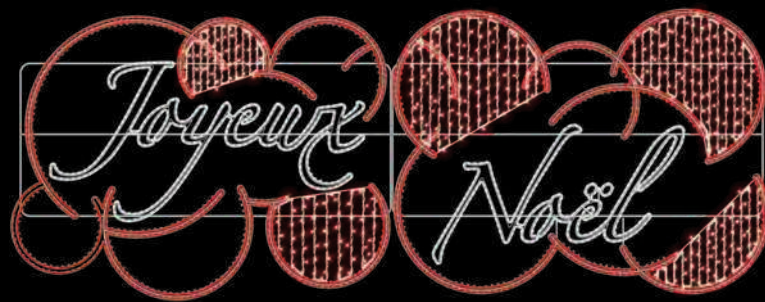

	1	2					
526180	flexiLED	flexiLED	STRING PLUS				
W							
186W	230V	CII	IP65 IP44, Plug	23,5kg	207x156x7,5cm	INC.	10mm

# Star Comet

550cm



MADE IN SPAIN  
Desing by PRILUX

Motivo  
Motifs  
Motifs  
Motivos

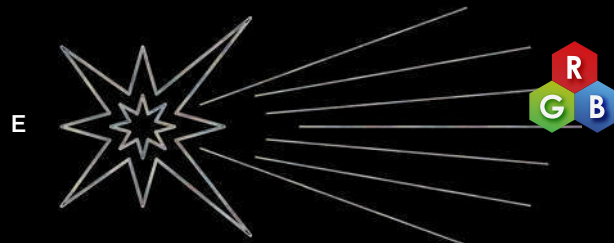
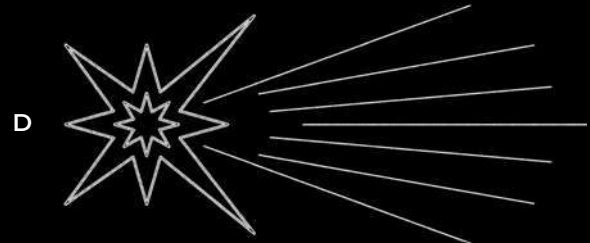
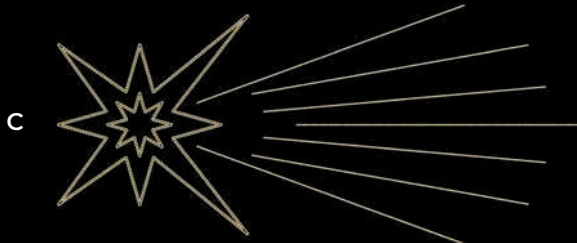
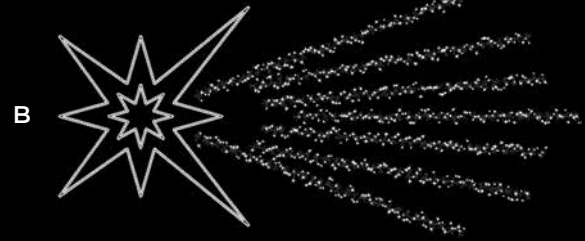
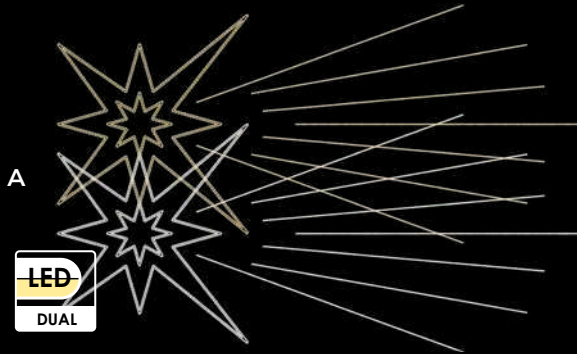

			W
392389	A	flexi LED	236W
392419	B	flexi LED / CLUSTER LED	70W
392433	C	flexi LED	178W
392426	D	flexi LED	178W
488716	E	flexi LED	280W

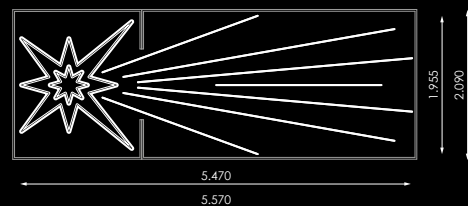

Cambio entre colores según función seleccionada.  
Switching between colors according to selected function.  
La commutation entre les couleurs en fonction de la fonction sélectionnée.  
Alternando entre as cores de acordo com a função selecionada.

230V	CII	IP65 IP44 Plug	25kg	1- 362x204x6cm 2- 162x204x6cm	INC.	25mm





MADE IN SPAIN  
Desing by PRILUX

# Star Comet

700cm

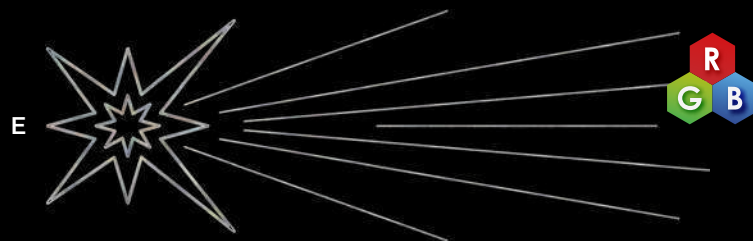
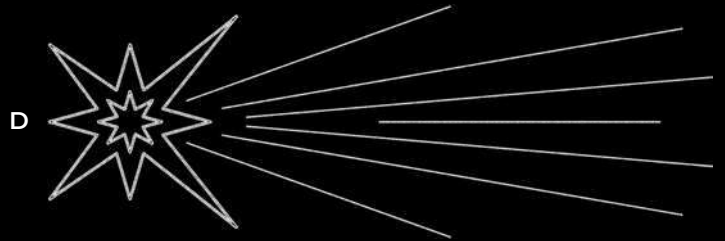
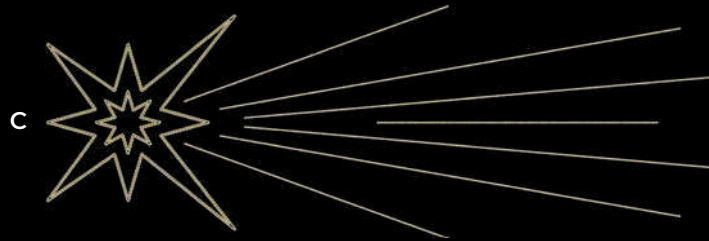
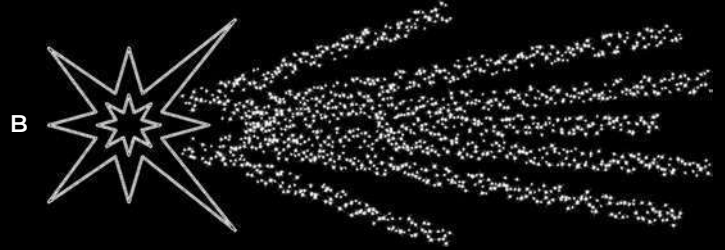
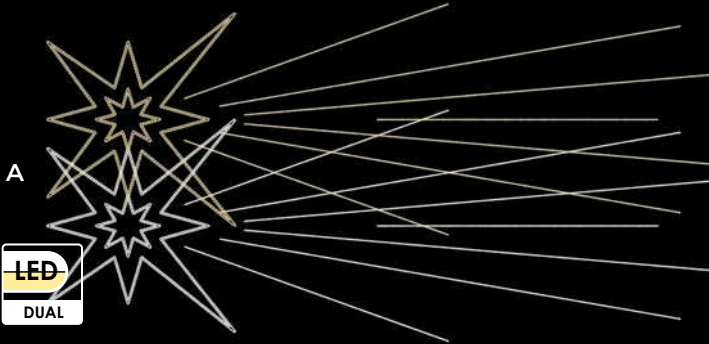

[GRÁFICOS: Unidades en mm/ GRAPHICS: Units in mm/ GRAPHIQUES: Unités en mm/ GRÁFICOS: Unidades em mm]

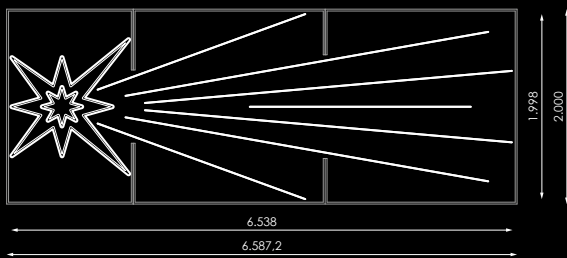

			W
209205	A	flexiLED	305W
240437	B	flexiLED / CLUSTER LED	78W
209243	C	flexiLED	218W
209236	D	flexiLED	218W
488723	E	flexiLED	368W



Cambio entre colores según función seleccionada.  
Switching between colors according to selected function.  
La commutation entre les couleurs en fonction de la fonction sélectionnée.  
Alternando entre as cores de acordo com a função selecionada.

230V	CII	IP65 IP44 Plug	28kg	1- 275x205x6cm 2- 162x205x6cm	INC.	25mm

# Portada Feria Lágrima

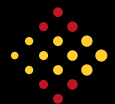

MADE IN SPAIN  
Desing by PRILUX

Motivo  
Motifs  
Motifs  
Motivos



N

NEW

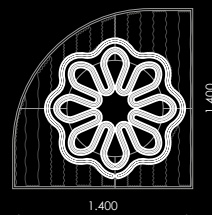
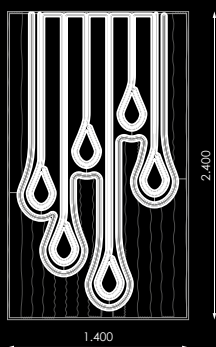
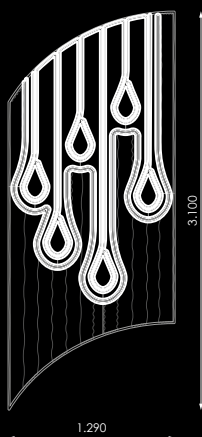

600187		flexi LED LED		STRING PLUS LED		
W	⚡	□	⊙	⚖	⌚	📏
1.025W	230V	CII	IP65 IP44 Plug	223kg	INC.	40x40mm

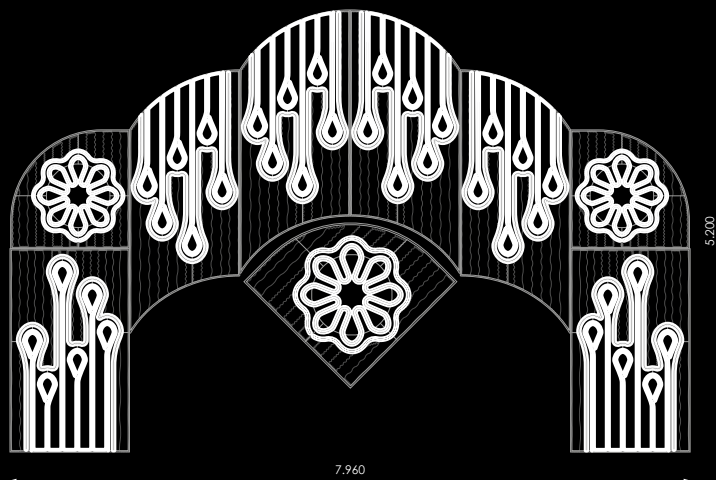

Bajo pedido / On request / Sur commande / A pedido

Ñ/ Posibilidad de diseños diferentes bajo proyecto.

E/ Possibility of different designs under project.

F/ Possibilité de différents designs en cours de projet.

P/ Possibilidade de diferentes desenhos sob projeto.





# Olas y Estrellas

## Pattern



MADE IN SPAIN  
Desing by PRILUX

Motivo  
Motifs  
Motifs  
Motivos



N

NEW



LATERAL  
IZQUIERDA



CENTRAL



LATERAL  
DERECHA



### CENTRAL



597593

flexiLED

STRING PLUS LED

Fall Lite Smart

W



52W

230V

CII

IP65  
IP44 Plug

10kg

210x210x7cm

INC. 10x10mm

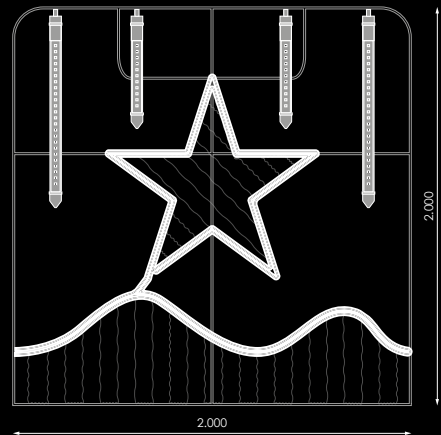

### LATERAL



597685

597661

flexiLED

STRING PLUS LED

Fall Lite Smart

W



43W

230V

CII

IP65  
IP44 Plug

7kg

210x135x7cm

INC. 10x10mm

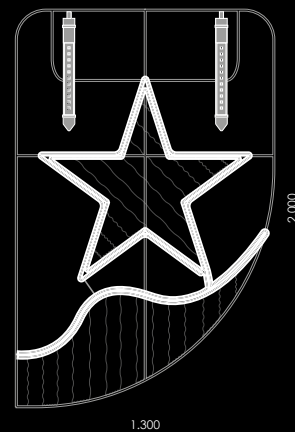





2,6m

Olas y Estrellas Pattern LATERAL

+

Olas y Estrellas Pattern LATERAL



4,6m

Olas y Estrellas Pattern LATERAL

+

Olas y Estrellas Pattern CENTRAL

+

Olas y Estrellas Pattern LATERAL

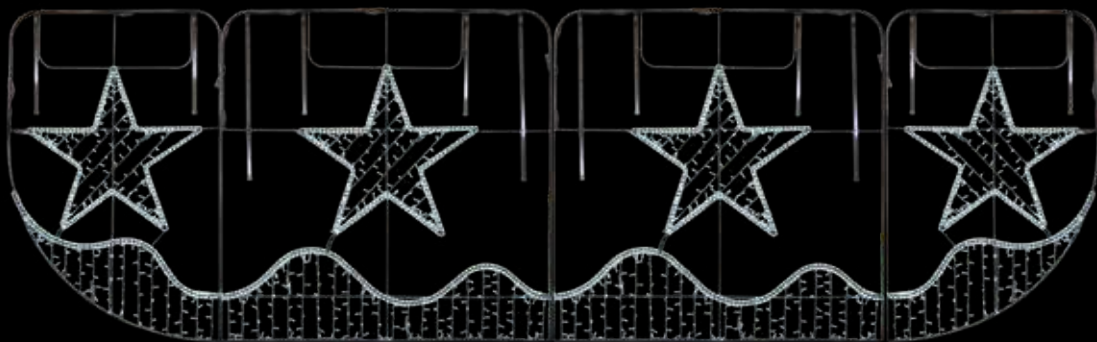

6,6m

Olas y Estrellas Pattern LATERAL

+

Olas y Estrellas Pattern CENTRAL

+

Olas y Estrellas Pattern CENTRAL

+

Olas y Estrellas Pattern LATERAL

Opción de composición/ Composition option  
 Option de composition/ Opção de composição

# Shooting Star Pattern



MADE IN SPAIN  
Desing by PRILUX

Motivo  
Motifs  
Motifs  
Motivos

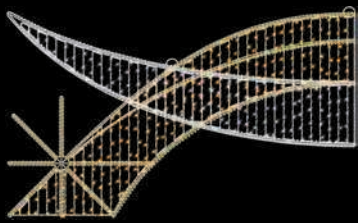

LATERAL  
IZQUIERDO

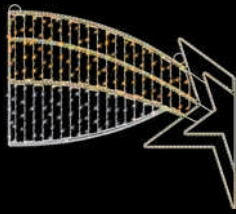

CENTRAL  
IZQUIERDO

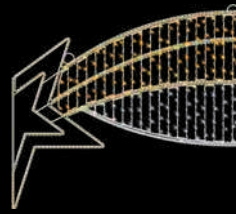

CENTRAL  
DERECHO

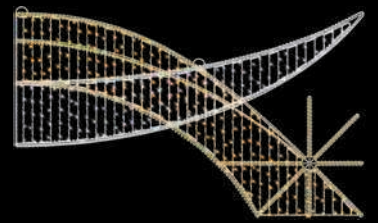

LATERAL  
DERECHO



CENTRAL

529983	560191	flexi	STRING
70,67W	230V	CII	INC. 10x10mm

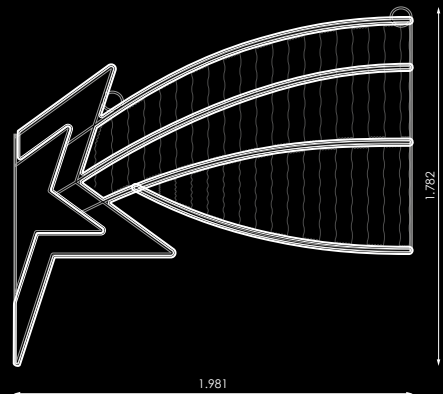

LATERAL

529952	529969	flexi	STRING
141,33W	230V	CII	INC. 10x10mm

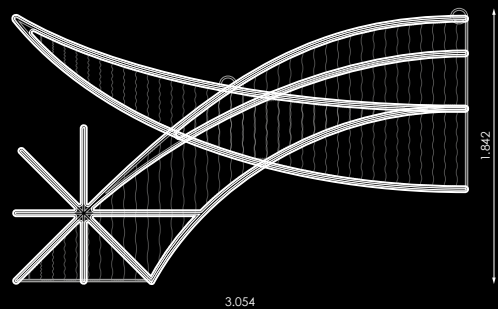



10m

Shooting Star Pattern LATERAL  
izquierda (529952)

+

Shooting Star Pattern CENTRAL  
izquierda (529983)

+

Shooting Star Pattern CENTRAL  
derecha (560191)

+

Shooting Star Pattern LATERAL  
derecha (529969)

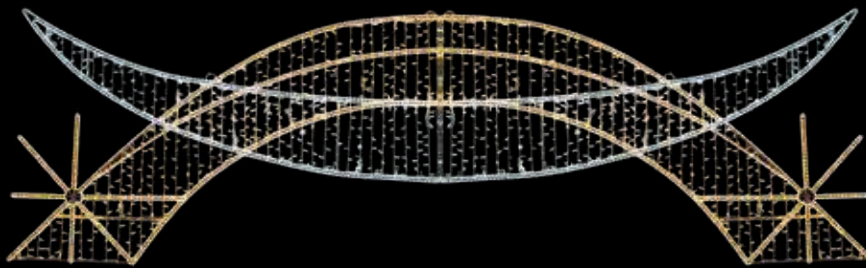

6m

Shooting Star Pattern LATERAL  
izquierda (529952)

+

Shooting Star Pattern LATERAL  
derecha (529969)



4m

Shooting Star Pattern CENTRAL  
izquierda (529983)

+

Shooting Star Pattern CENTRAL  
derecha (560191)

Opción de composición/ Composition option  
Option de composition/ Opção de composição

# Ice Waves

## Pattern



MADE IN SPAIN  
Desing by PRILUX

Motivo  
Motifs  
Motifs  
Motivos



CENTRAL



LATERAL



CENTRAL

560306 flexi LED LED STRING PLUS LED LED

W ⚡ □ ○ ○ /kg ⊞ ⚗ □

91W 230V CII IP65 IP44 Plug 6,5kg 147x173x7,5cm INC. 20x10mm



LATERAL

560290 flexi LED LED STRING PLUS LED LED

W ⚡ □ ○ ○ /kg ⊞ ⚗ □

87W 230V CII IP65 IP44 Plug 10,5kg 205x173x7,5cm INC. 20x10mm

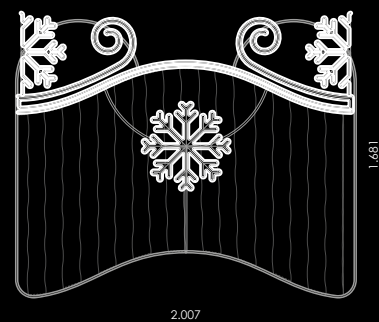





5,4m

Ice Waves Pattern LATERAL

+

Ice Waves Pattern CENTRAL

+

Ice Waves Pattern LATERAL



8m

Ice Waves Pattern  
LATERAL

+

Ice Waves Pattern  
LATERAL

+

Ice Waves Pattern  
LATERAL

+

Ice Waves Pattern  
LATERAL



4,25m

Ice Waves Pattern CENTRAL

+

Ice Waves Pattern CENTRAL

+

Ice Waves Pattern CENTRAL

Opción de composición/ Composition option  
Option de composition/ Opção de composição

# Screen PIXELMAX



MADE IN SPAIN  
Desing by PRILUX

Motivo  
Motifs  
Motifs  
Motivos

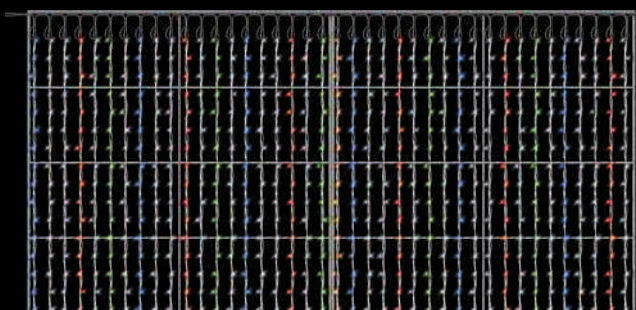

562126		SCREEN PIXELMAX LED					
W	⚡	□	⊙	kg	⊞	⊥	□
528W	66V ac	CII	IP44	65kg	205x205x15cm	INC.	20x20mm

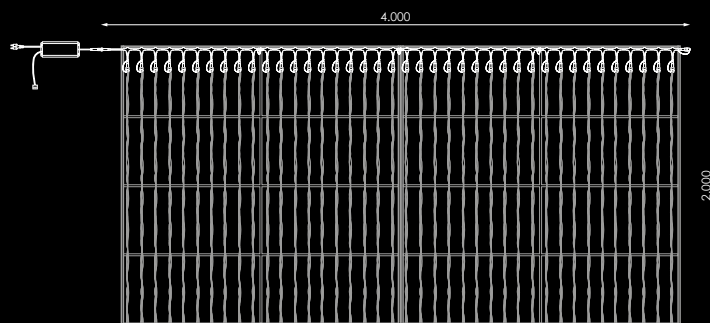

## Información/Information/Information/Informações

**Ñ/** Controlador Master y Slave servidos en caja estanca IP66.

**E/** Master and Slave controller served in IP66 watertight box.

**F/** Contrôleur maître et esclave servi dans une boîte étanche IP66.

**P/** Controladores Master e Slave servidos em caixa estanque IP66.



MADE IN SPAIN  
Desing by PRILUX

# Daisy Flower

N  
NEW



Motivo  
Motifs  
Motifs  
Motivos

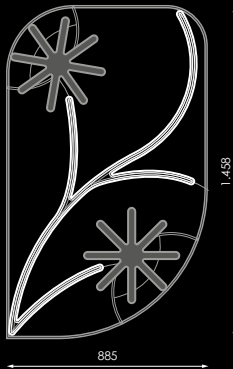

597777	flexiLED	ALPHA					
W							
26W	230V	CII	IP65 IP44 Plug	5kg	150x93x7cm	INC.	20x10mm



MADE IN SPAIN  
Desing by PRILUX

# Abies

N  
NEW



Motivo  
Motifs  
Motifs  
Motivos

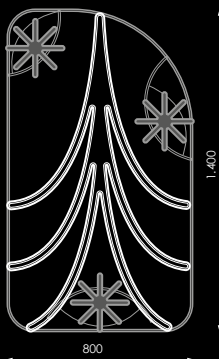

600200	flexiLED	ALPHA					
W							
34,5W	230V	CII	IP65 IP44 Plug	6kg	150x93x7cm	INC.	20x10mm

[GRÁFICOS: Unidades en mm/ GRAPHICS: Units in mm/ GRAPHIQUES: Unités en mm/ GRÁFICOS: Unidades em mm]

# Three Star

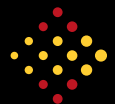

MADE IN SPAIN  
Desing by PRILUX

Motivo  
Motifs  
Motifs  
Motivos



**N**  
NEW



Three Stars

+

Three Stars

Opción de composición/ Composition option  
Option de composition/ Opção de composição

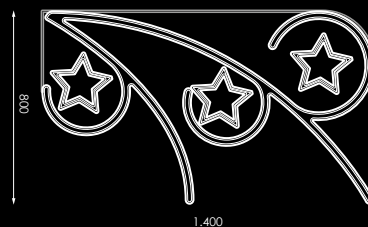

600217		flexi <b>LED</b> <b>LED</b>					
W							
64,5W	230V	CII	IP65 IP44 Plug	7kg	150x93x7cm	INC.	20x10mm

# Bolas

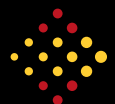

MADE IN SPAIN  
Desing by PRILUX

Motivo  
Motifs  
Motifs  
Motivos



**N**  
NEW



Bolas

+

Bolas

Opción de composición/ Composition option  
Option de composition/ Opção de composição

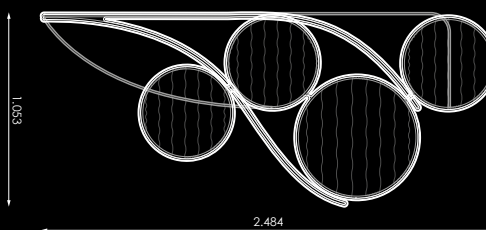
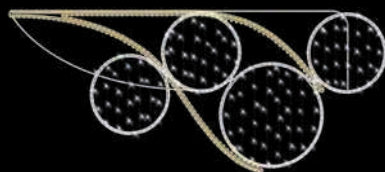

600224		flexi <b>LED</b> <b>LED</b>		STRING <b>PLUS</b> <b>LED</b> <b>LED</b>			
W							
60W	230V	CII	IP65 IP44 Plug	9kg	253x110x7cm	INC.	20x10mm





MADE IN SPAIN  
Desing by PRILUX

# Silhouette Star



Silhouette Star + Fly + Silhouette Star

Opción de composición/ Composition option  
Option de composition/ Opção de composição

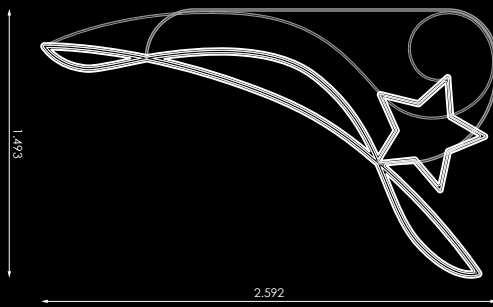

Motivo  
Motifs  
Motifs  
Motivos



529020	flexiLED	flexiLED	STRING PLUS	LED			
51W	230V	CII	IP65 IP44 Plug	6kg	154x264x5cm	INC.	20x10mm



MADE IN SPAIN  
Desing by PRILUX

# Star Duo

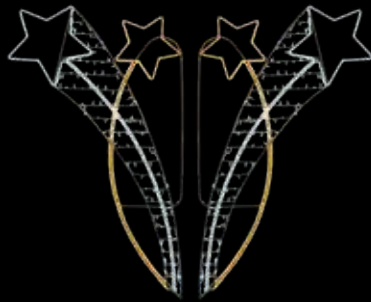

Star Duo + Star Duo

Opción de composición/ Composition option  
Option de composition/ Opção de composição

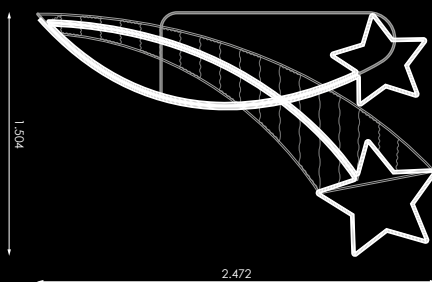

Motivo  
Motifs  
Motifs  
Motivos



529099	flexiLED	LED	STRING PLUS	LED			
45,6W	230V	CII	IP65 IP44 Plug	6kg	155x252x5cm	INC.	20x10mm

[GRÁFICOS: Unidades en mm/ GRAPHICS: Units in mm/ GRÁFICOS: Unidades en mm/ GRAPHICS: Units in mm/ GRÁFICOS: Unidades en mm/ GRAPHICS: Units in mm]

# Eclectic Ulva

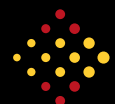

MADE IN SPAIN  
Desing by PRILUX

Motivo  
Motifs  
Motifs  
Motivos



A B C



Eclectic Ulva + Tulip + Eclectic Ulva

Opción de composición/ Composition option  
Option of composition/ Opção de composição

				W
509961	A	flexiLED	STRING PLUS LED	41W
509978	B	flexiLED	STRING PLUS LED	35W
509985	C	flexiLED	STRING PLUS LED	35W

⚡	□	⊙	⚖	📦	🔌	📏
230V	CII	IP65 IP44 Plug	6,5kg	191x108x5cm	INC.	10mm

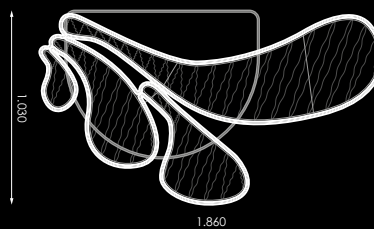

# Eclectic Fan

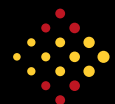

MADE IN SPAIN  
Desing by PRILUX

Motivo  
Motifs  
Motifs  
Motivos



A B C



Eclectic Fan + Kabalah + Eclectic Fan

Opción de composición/ Composition option  
Option of composition/ Opção de composição

			1	2	W
510066	A	flexiLED	STRING PLUS LED	-	90W
510073	B	flexiLED	STRING PLUS LED	STRING PLUS LED	80W
510080	C	flexiLED	STRING PLUS LED	STRING PLUS LED	80W

⚡	□	⊙	⚖	📦	🔌	📏
230V	CII	IP65 IP44 Plug	9kg	188x115x5cm	INC.	10mm



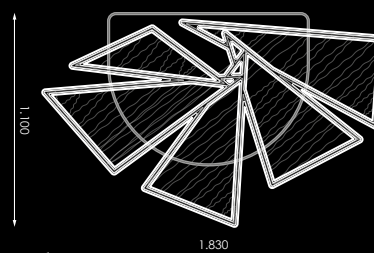

MADE IN SPAIN  
Desing by PRILUX

# Eclectic Nari



Ávila

Motivo  
 Motifs  
 Motifs  
 Motivos



Eclectic Nari

+

Tear

+

Eclectic Nari



A

B

C



Opción de composición/ Composition option  
Option de composition/ Opção de composição

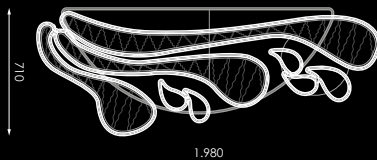

				W
509916	A	flexi	STRING	50W
509923	B	flexi	STRING	43W
509930	C	flexi	STRING	43W

230V	CII	IP65 IP44 Plug	7kg	203x76x5cm	INC.	10mm

[GRÁFICOS: Unidades en mm/ GRAPHICS: Units in mm/ GRÁFICOS: Unidades en mm/ GRAPHICS: Units in mm/ GRÁFICOS: Unidades en mm/ GRAPHICS: Units in mm]

# Eclectic Slope

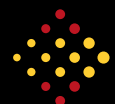

MADE IN SPAIN  
Desing by PRILUX

Motivo  
Motifs  
Motifs  
Motivos



A B C



Fly + Eclectic Slope + Fly

Opción de composición/ Composition option  
Option de composition/ Opção de composição

				W
510011	A	<b>flexiLED</b>	STRING <b>PLUS</b> <b>LED</b>	60W
510028	B	<b>flexiLED</b>	STRING <b>PLUS</b> <b>LED</b>	55W
510035	C	<b>flexiLED</b>	STRING <b>PLUS</b> <b>LED</b>	55W

230V	CII	IP65 IP44 Plug	6kg	194x80x5cm	INC.	10mm

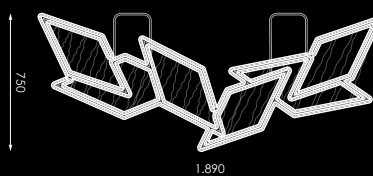

# Eclectic Hive



MADE IN SPAIN  
Desing by PRILUX

Motivo  
Motifs  
Motifs  
Motivos

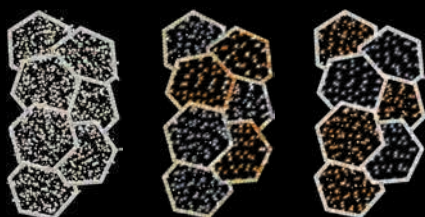

A B C

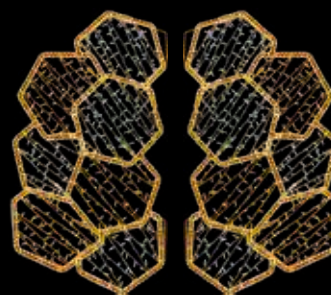

Eclectic Hive + Eclectic Hive

Opción de composición/ Composition option  
Option de composition/ Opção de composição

					W
510110	A	<b>flexiLED</b>	STRING <b>PLUS</b> <b>LED</b>	-	83W
510127	B	<b>flexiLED</b>	STRING <b>PLUS</b> <b>LED</b>	STRING <b>PLUS</b> <b>LED</b>	74W
510134	C	<b>flexiLED</b>	STRING <b>PLUS</b> <b>LED</b>	STRING <b>PLUS</b> <b>LED</b>	74W

230V	CII	IP65 IP44 Plug	8kg	188x102x5cm	INC.	10mm



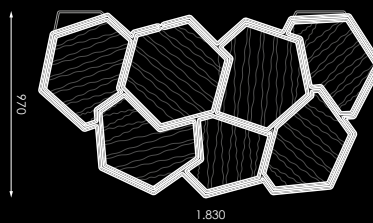



MADE IN SPAIN  
Desing by PRILUX

# Infinity



Ávila

**Motivo**  
 Motifs  
 Motifs  
 Motivos



Nadir

+

Nadir

Opción de composición/ Composition option  
Option de composition/ Opção de composição

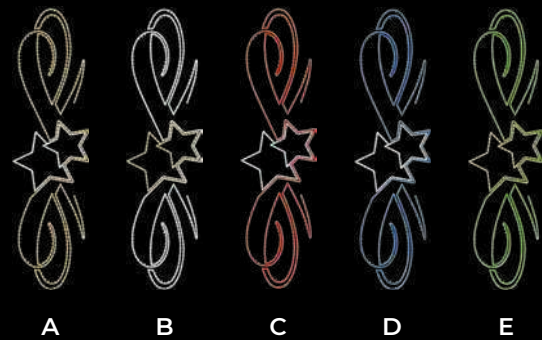

A

B

C

D

E

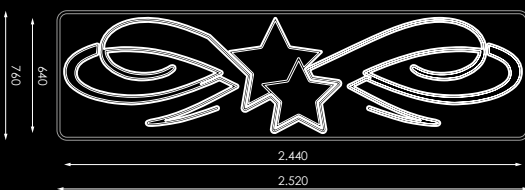

416092	A		
416108	B		
416115	C		
416122	D		
416139	E		

W							
45W	230V	CII	IP65 IP44 Plug	6kg	260x78x5cm	INC.	10mm

[GRÁFICOS: Unidades en mm/ GRAPHICS: Units in mm/ GRÁFICOS: Unidades en mm/ GRAPHICS: Units in mm/ GRÁFICOS: Unidades en mm/ GRAPHICS: Units in mm]

# Nadir

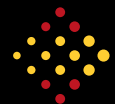

MADE IN SPAIN  
Desing by PRILUX

Motivo  
Motifs  
Motifs  
Motivos



Nadir + Nadir

Opción de composición/ Composition option  
Option de composition/ Opção de composição

385954	A	flexi LED	STRING PLUS				
385961	B	flexi LED	STRING PLUS				
W	⚡	⏏	⦿	⚖	📦	🔌	📏
64W	230V	CII	IP65 IP44 Plug	11kg	128x263x5cm	INC.	20x10mm

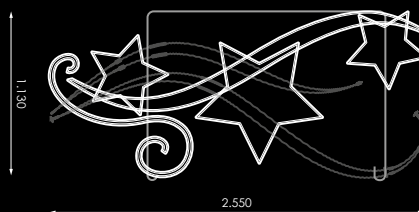

# Wimbi String

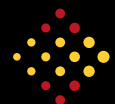

MADE IN SPAIN  
Desing by PRILUX

Motivo  
Motifs  
Motifs  
Motivos

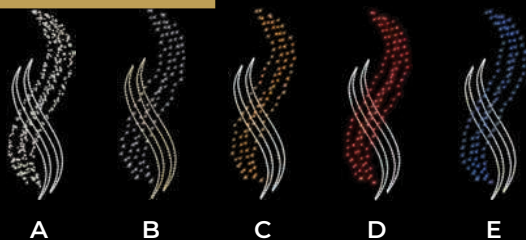

Wimbi String + Arkaid + Wimbi String

Opción de composición/ Composition option  
Option de composition/ Opção de composição

488747	A	flexi LED	STRING PLUS				
415453	B	flexi LED	STRING PLUS				
415460	C	flexi LED	STRING PLUS				
415477	D	flexi LED	STRING PLUS				
415484	E	flexi LED	STRING PLUS				
W	⚡	⏏	⦿	⚖	📦	🔌	📏
23W	230V	CII	IP65 IP44 Plug	4kg	73x205x5cm	INC.	10mm

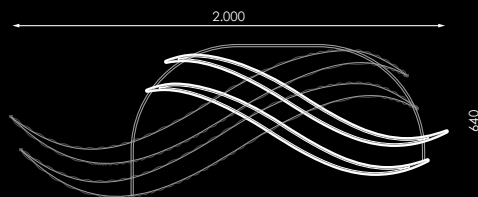



MADE IN SPAIN  
Desing by PRILUX

# Wimbi



Motivo  
Motifs  
Motifs  
Motivos

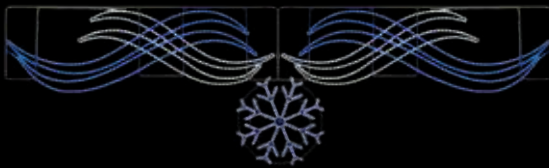

Wimbi

+

Wimbi

Opción de composición/ Composition option  
Option de composition/ Opção de composição

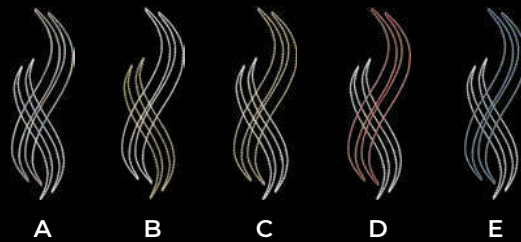
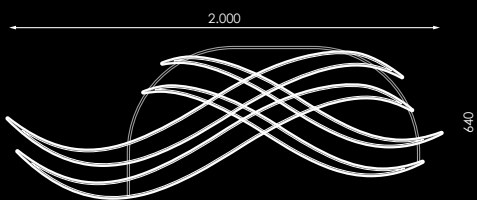

488730	A		
412902	B		
415408	C		
415415	D		
415422	E		

W



40W

230V

CII

IP65  
IP44 Plug

4kg

73x205x5cm

INC.

10mm

[GRÁFICOS: Unidades en mm/ GRAPHSICS: Units in mm/ GRAPHIQUES: Unités en mm/ GRÁFICOS: Unidades em mm]

# Angelo's Neon



MADE IN SPAIN  
Desing by PRILUX

Motivo  
Motifs  
Motifs  
Motivos



A



B



C



D



Barcode	Model	Name	Material
529662	A	ARPA	flexiDOUBLE NEON LED LED
529679	B	TROMPETA	flexiDOUBLE NEON LED LED
529686	C	CANDELA	flexiDOUBLE NEON LED LED
529693	D	CAMPANA	flexiDOUBLE NEON LED LED

W	⚡	⊞	⊙	⚖	📦	⚡	📏
99W	230V	CII	IP65 IP44 Plug	5kg	140x192x5cm	INC.	10mm



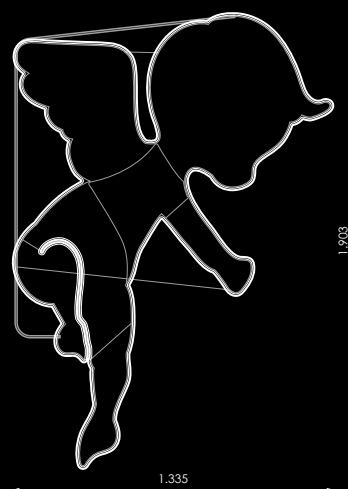



MADE IN SPAIN  
Desing by PRILUX

# Angel Vela



Motivo  
Motifs  
Motifs  
Motivos

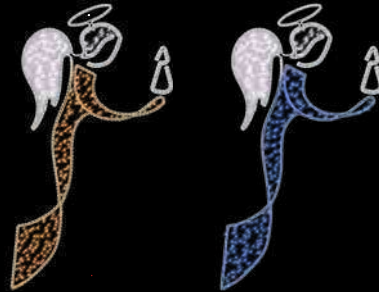

A

B

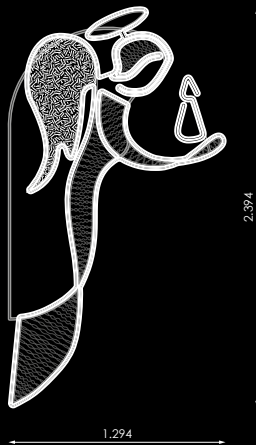

210003	A	flexi LED LED	STRING PLUS LED LED	TAPIZ			
387408	B	flexi LED LED	STRING PLUS LED LED	TAPIZ			
W	⚡	□	⊙	⚖	📦	🔌	📏
62,5W	230V	CII	IP65 IP44 Plug	7,5kg	150x263x5cm	INC.	20x10mm



MADE IN SPAIN  
Desing by PRILUX

# Céfiro



Motivo  
Motifs  
Motifs  
Motivos



Céfiro

+

Star Mini

+

Céfiro



A

B



Opción de composición/ Composition option  
Option de composition/ Opção de composição

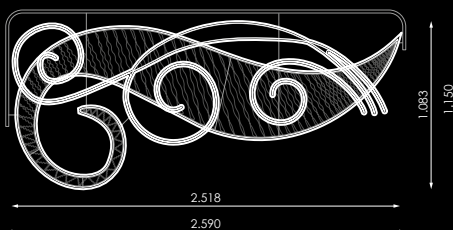

386159	A	flexi LED LED	STRING PLUS LED				
385893	B	flexi LED LED	STRING PLUS LED				
W	⚡	□	⊙	⚖	📦	🔌	📏
102W	230V	CII	IP65 IP44 Plug	11kg	116x268x5cm	INC.	20x10mm

[GRÁFICOS: Unidades en mm/ GRAPHICS: Units in mm/ GRÁFICOS: Unidades en mm/ GRAPHICS: Units in mm/ GRÁFICOS: Unidades en mm]

# Acanto

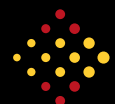

MADE IN SPAIN  
Desing by PRILUX

Motivo  
Motifs  
Motifs  
Motivos

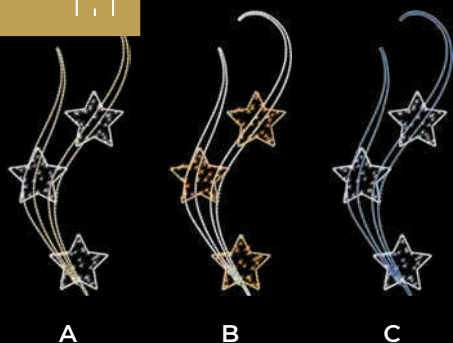

Acanto + Star mini + Acanto

Opción de composición/ Composition option  
Option de composition/ Opção de composição

385992	A	flexi LED LED	STRING PLUS LED				
386005	B	flexi LED LED	STRING PLUS LED				
386012	C	flexi LED LED	STRING PLUS LED				
W	⚡	⏏	⦿	⚖	📦	🔌	📏
55W	230V	CII	IP65 IP44 Plug	9kg	118x268x5cm	INC.	10mm

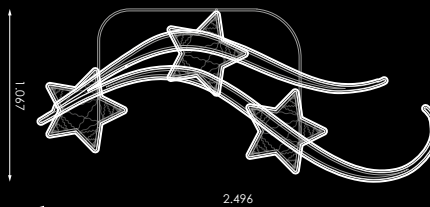

# Spiral Loop

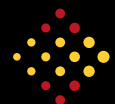

MADE IN SPAIN  
Desing by PRILUX

Motivo  
Motifs  
Motifs  
Motivos

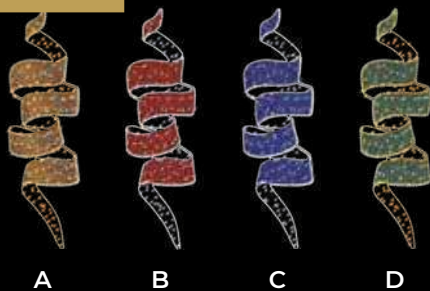

Spiral Loop + Spiral Loop

Opción de composición/ Composition option  
Option de composition/ Opção de composição

209267	A	flexi LED	STRING PLUS LED	TAPIZ			
209274	B	flexi LED	STRING PLUS LED LED	TAPIZ			
209281	C	flexi LED	STRING PLUS LED LED	TAPIZ			
209298	D	flexi LED	STRING PLUS LED LED	TAPIZ			
W	⚡	⏏	⦿	⚖	📦	🔌	📏
36W	230V	CII	IP65 IP44 Plug	7,5kg	80x263x5cm	INC.	25mm

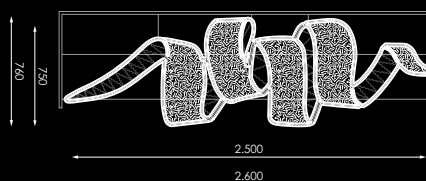



MADE IN SPAIN  
Desing by PRILUX

# Flower Star







Motivo  
Motifs  
Motifs  
Motivos



Flower Star

+

Star mini  
Double

+

Flower Star



A



B



OPCIÓN DE COMPOSICIÓN/ COMPOSITION OPTION  
OPTION DE COMPOSITION/ OPÇÃO DE COMPOSIÇÃO

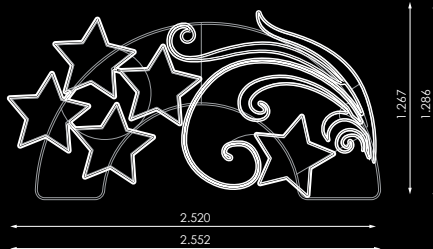

			
	209403	A	flexi  
	209434	B	flexi  
W			
78W	230V	CII	IP65 IP44 Plug
			11kg
			138x258x5cm
			INC. 20x10mm

[GRÁFICOS: Unidades en mm/ GRAPHICS: Units in mm/ GRAPHIQUES: Unités en mm/ GRÁFICOS: Unidades em mm]





Avila





MADE IN SPAIN  
Desing by PRILUX



Flambeau + Tears + Flambeau

Opción de composición/ Composition option  
Option de composition/ Opção de composição

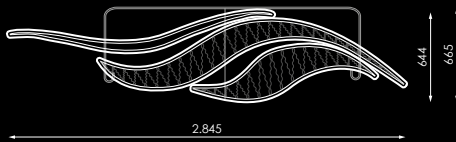

# Flambeau



A B C D



		□	■
209717	A	flexiLED	STRING PLUS LED
209724	B	flexiLED	STRING PLUS LED
209731	C	flexiLED	STRING PLUS LED
209748	D	flexiLED	STRING PLUS LED

W	⚡	□	⦿	⚖	📦	🔌	📏
42W	230V	CII	IP65 IP44 Plug	6,5kg	67x305x5cm	INC.	20x10mm



MADE IN SPAIN  
Desing by PRILUX

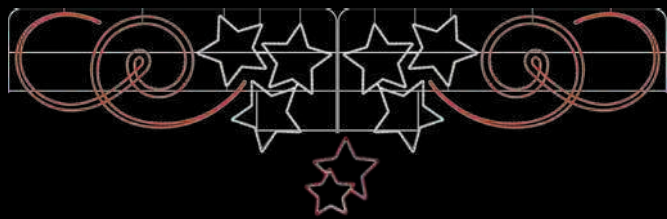

Spiral Star + Double star + Spiral Star

Opción de composición/ Composition option  
Option de composition/ Opção de composição

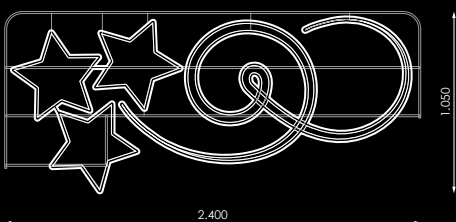

# Spiral Star

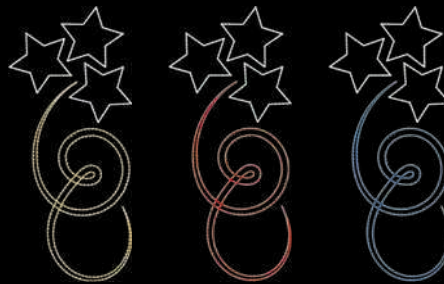

A B C



		□	■
209311	A	flexiLED	LED
209335	B	flexiLED	LED
209328	C	flexiLED	LED

W	⚡	□	⦿	⚖	📦	🔌	📏
47W	230V	CII	IP65 IP44 Plug	7kg	111x250x5cm	INC.	20x10mm

[GRÁFICOS: Unidades en mm/ GRAPHICS: Units in mm/ GRÁFICOS: Unidades em mm/ GRAPHICS: Units in mm]

Motivo  
Motifs  
Motifs  
Motivos



Guadalupe  
Cáceres



Agard

+

Arkaid

+

Agard

Opción de composición/ Composition option  
Option de composition/ Opção de composição



209823	A	flexi LED LED	STRING PLUS LED
209847	B	flexi LED LED	STRING PLUS LED
209878	C	flexi LED LED	STRING PLUS LED

W							
45W	230V	CII	IP65 IP44 Plug	8kg	80x312x5cm	INC.	25mm



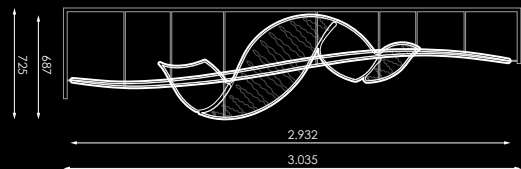

MADE IN SPAIN  
Desing by PRILUX

# Arabesque



Motivo  
Motifs  
Motifs  
Motivos

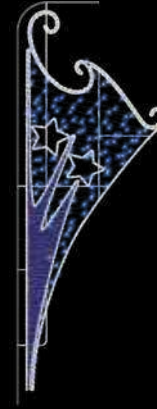
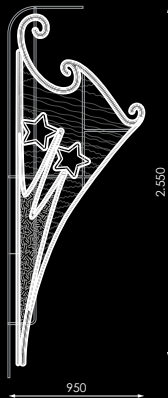

148986	flexi LED	STRING PLUS LED	TAPIZ				
W	⚡	□	⊙	⚖	📦	🔌	📏
51W	230V	CII	IP65 IP44 Plug	7kg	105x273x5cm	INC.	20x10mm



MADE IN SPAIN  
Desing by PRILUX

# Estrellas



Motivo  
Motifs  
Motifs  
Motivos



Estrellas

+

Estrellas

Opción de composición/ Composition option  
Option de composition/ Opção de composição

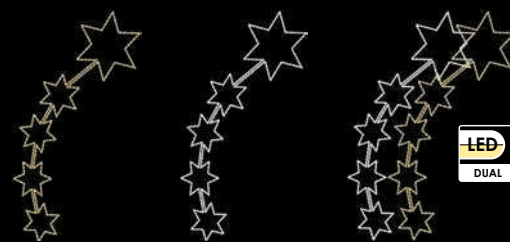

A

B

C

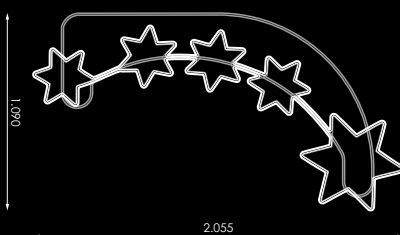

385244	A	flexi LED	21W			
972062	B	flexi LED	21W			
385251	C	flexi LED	25W			
⚡	□	⊙	⚖	📦	🔌	📏
230V	CII	IP65 IP44 Plug	8kg	121x210x5cm	INC.	20x10mm

[GRÁFICOS: Unidades en mm/ GRAPHICS: Units in mm/ GRÁFICOS: Unidades em mm/ GRAPHICS: Units in mm]

# Bolas con Lazo



MADE IN SPAIN  
Desing by PRILUX

Motivo  
Motifs  
Motifs  
Motivos



**N**  
NEW



		1	2
600231	flexi LED LED	STRING PLUS LED	STRING PLUS LED
595360	flexi LED LED	STRING PLUS LED	STRING PLUS LED
W	⚡	□	⦿
70W	230V	CII	IP65 IP44 Plug
		8kg	128x191x7cm
			INC. 10x10mm

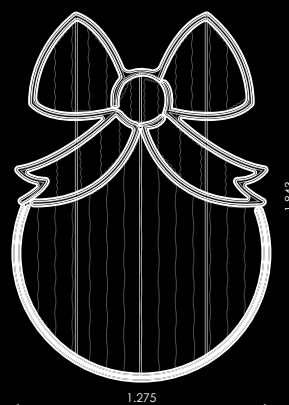

Accesorios (NO Incluidos) / Accessoires (NOT Included) / Accessories (NON Inclus) / Acessórios (NÃO Incluso)  
+ INFO PAG. página 157



Brazo para motivos Calle/Fachada/Mini





MADE IN SPAIN  
Desing by PRILUX

# Campana con Lazo

N  
NEW



Motivo  
Motifs  
Motifs  
Motivos

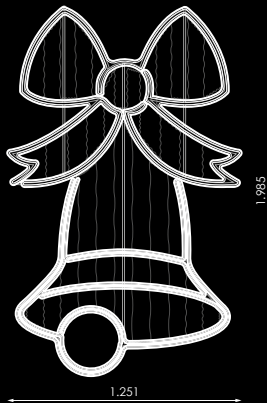

595353	flexi	STRING	STRING				
W							
88W	230V	CII	IP65 IP44 Plug	8,5kg	129x211x7cm	INC.	10x10mm



Accesorios (NO Incluidos) / Accessoires (NOT Included) / Accessories (NON Inclus) / Acessórios (NÃO Incluso)  
+ INFO PAC, página 157



Bravo para motivos Calle/Fachada/Mini

[GRÁFICOS: Unidades en mm/ GRÁFICOS: Units in mm/ GRAPHICS: Units in mm/ GRÁFICOS: Unidades em mm]

# Melchor



MADE IN SPAIN  
Desing by PRILUX

Motivo  
Motifs  
Motifs  
Motivos



567190	flexi LED LED LED	STRING PLUS LED					
W	⚡	□	○	⚖	📦	🔌	📏
84W	230V	CII	IP65 IP44 Plug	8kg	110x225x5cm	INC.	10x20mm

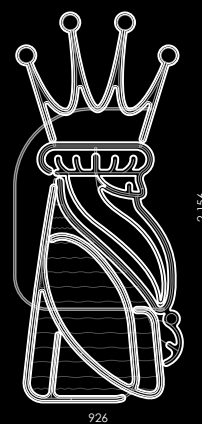

# Gaspar



MADE IN SPAIN  
Desing by PRILUX

Motivo  
Motifs  
Motifs  
Motivos



567206	flexi LED LED LED	STRING PLUS LED					
W	⚡	□	○	⚖	📦	🔌	📏
87W	230V	CII	IP65 IP44 Plug	8kg	110x225x5cm	INC.	10x20mm

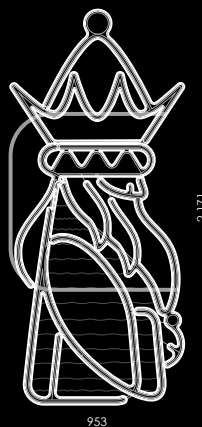







Bargas  
Toledo





MADE IN SPAIN  
Desing by PRILUX

# Baltasar



Motivo  
Motifs  
Motifs  
Motivos

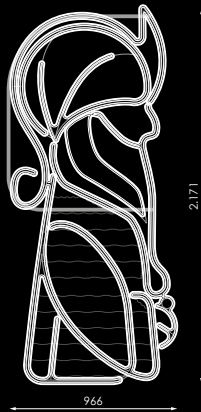

567213		flexi LED LED LED LED				STRING PLUS LED		
W	⚡	□	⊙	⚖	📦	🔌	📏	
96W	230V	CII	IP65 IP44 Plug	8,5kg	110x225x5cm	INC.	10x20mm	

[GRÁFICOS: Unidades en mm/ GRAPHICS: Units in mm/ GRAPHIQUES: Unités en mm/ GRÁFICOS: Unidades en mm]



MADE IN SPAIN  
Desing by PRILUX

# Camello



Motivo  
Motifs  
Motifs  
Motivos

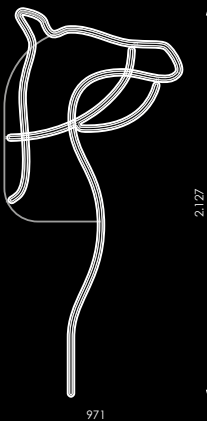

567220		flexi LED LED					
W	⚡	□	⊙	⚖	📦	🔌	📏
36W	230V	CII	IP65 IP44 Plug	3,5kg	110x225x5cm	INC.	10x20mm

# Bolma

## Lilium



MADE IN SPAIN  
Desing by PRILUX

Motivo  
Motifs  
Motifs  
Motivos



567237	flexi	STRING PLUS					
W							
123W	230V	CII	IP65 IP44 Plug	13,5kg	190x1905x7,5cm	INC.	10x20mm

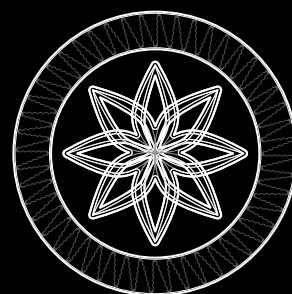

Ø1.800

# Bolma

## Arkaid



MADE IN SPAIN  
Desing by PRILUX

Motivo  
Motifs  
Motifs  
Motivos



567244	flexi	STRING PLUS					
W							
111W	230V	CII	IP65 IP44 Plug	11,5kg	190x1905x7,5cm	INC.	10x20mm

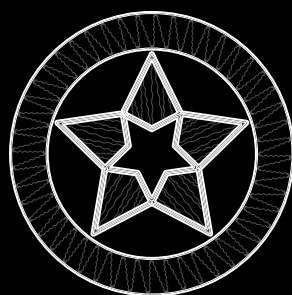

Ø1.800



MADE IN SPAIN  
Desing by PRILUX

# Bolma

## Star Flake

**Motivo**  
 Motifs  
 Motifs  
 Motivos

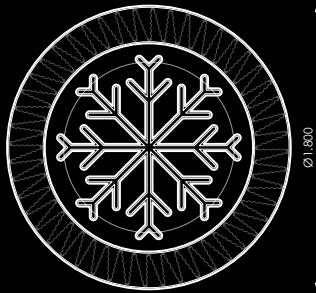

567251	<b>flexiLED</b>	STRING <b>PLUS</b> <b>LED</b>					
<b>W</b>							
120W	230V	CI	IP65 IP44 Plug	11,4kg	190x1905x7,5cm	INC.	10x20mm

[GRÁFICOS: Unidades en mm/ GRAPHICS: Units in mm/ GRÁFICOS: Unidades em mm]



MADE IN SPAIN  
Desing by PRILUX

# Bulán

**Motivo**  
 Motifs  
 Motifs  
 Motivos

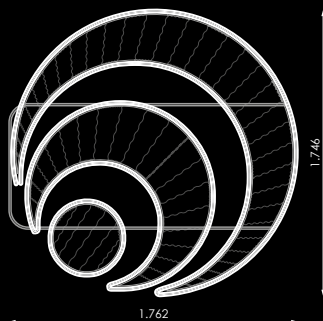
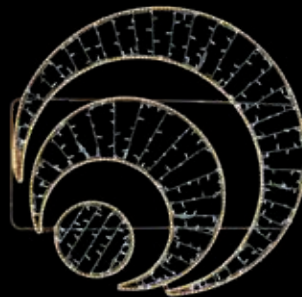

529082	<b>flexiLED</b>	STRING <b>PLUS</b> <b>LED</b>					
<b>W</b>							
58,6W	230V	CI	IP65 IP44 Plug	7,3kg	190x190x7,5cm	INC.	10x20mm

# Bulán

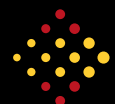

MADE IN SPAIN  
Desing by PRILUX

Motivo  
Motifs  
Motifs  
Motivos



A B C

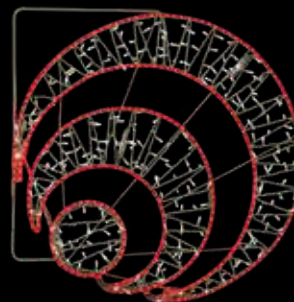

	1	2	
414982	A	flexi LED	STRING PLUS LED
567343	B	flexi LED	STRING PLUS LED
567350	C	flexi LED	STRING PLUS LED

W	⚡	□	⊙	⚖	📦	🔌	📏
36W	230V	CII	IP65 IP44 Plug	6kg	115x115x5cm	INC.	10mm

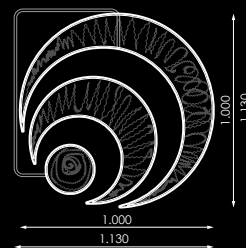

# Stea



MADE IN SPAIN  
Desing by PRILUX

Motivo  
Motifs  
Motifs  
Motivos



A B C

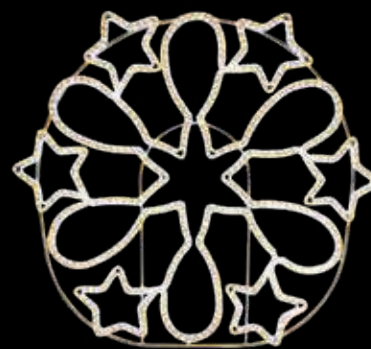

	1	2	
441629	A	flexi LED	flexi LED
441636	B	flexi LED	flexi LED
441643	C	flexi LED	flexi LED

W	⚡	□	⊙	⚖	📦	🔌	📏
78W	230V	CII	IP65 IP44 Plug	8kg	135x160x5cm	INC.	10mm



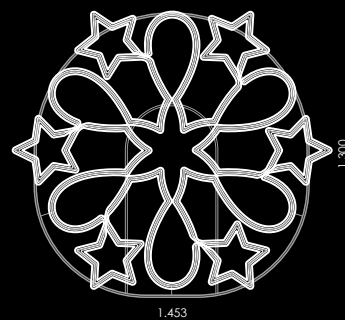



CC. Way Dos Hermanas  
Dos Hermanas, Sevilla

# Cometa II



MADE IN SPAIN  
Desing by PRILUX

Motivo  
Motifs  
Motifs  
Motivos



A



B



C



			W
489560	A	flexi DOUBLE NEON	63W
488815	B	flexi DOUBLE NEON	63W
488785	C	flexi	32.2W

230V	CII	IP65 IP44 Plug	2kg	110x50x5cm	INC.	10x10mm

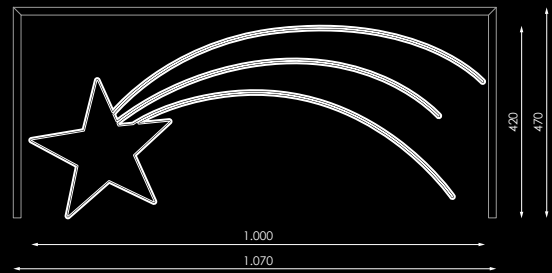

			W
489577	A	flexi DOUBLE NEON	90W
488822	B	flexi DOUBLE NEON	90W
488792	C	flexi	46W

230V	CII	IP65 IP44 Plug	3,5kg	159x71x5cm	INC.	10x10mm

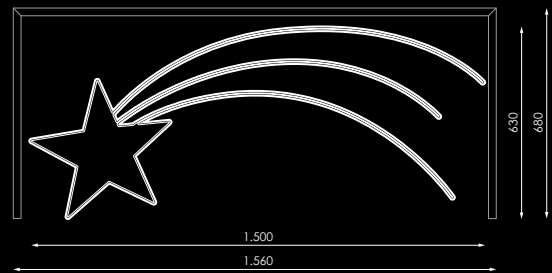

			W
489584	A	flexi DOUBLE NEON	189W
488839	B	flexi DOUBLE NEON	189W
488808	C	flexi	96.6W

230V	CII	IP65 IP44 Plug	9kg	311x133x5cm	INC.	20x10mm



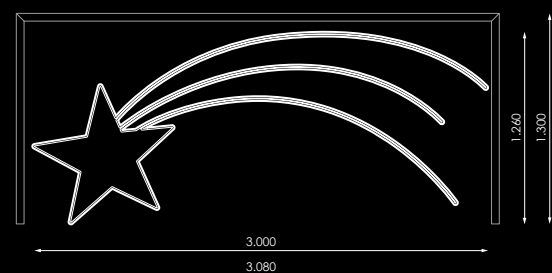



MADE IN SPAIN  
Desing by PRILUX

# Reyes Magos con Estrella Fugaz





**Motivo**  
 Motifs  
 Motifs  
 Motivos

[GRÁFICOS: Unidades en mm/ GRAPHICS: Units in mm/GRAPHIQUES: Unités en mm/GRÁFICOS: Unidades en mm]

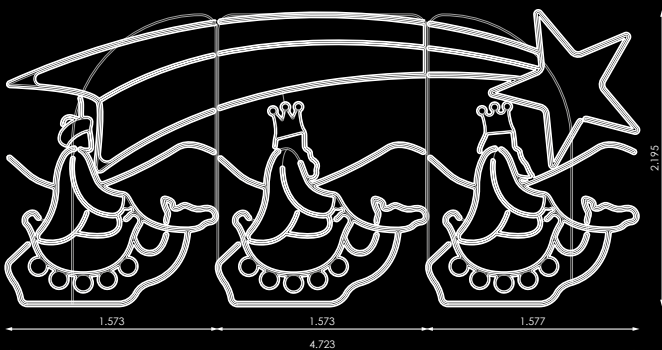

567367		flexi LED LED					
W	⚡	□	⊙	⚖	📦	⏏	📏
306W	230V	CII	IP65 IP44 Plug	28kg	170x230x20cm	INC.	10x20mm









MADE IN SPAIN  
Desing by PRILUX

# Belén

## 2D



**Motivo**  
 Motifs  
 Motifs  
 Motifs



563635		flexi <b>LED</b> <b>LED</b>					
W	⚡	□	⊙	⚖	📦	⏏	📏
153W	230V	ClI	IP65 IP44 Plug	15kg	280x200x7,5cm	INC.	10x20mm



MADE IN SPAIN  
Desing by PRILUX

# Belén

## 2D String



**Motivo**  
 Motifs  
 Motifs  
 Motifs



564823		flexi <b>LED</b> <b>LED</b> STRING <b>PLUS</b> <b>LED</b> <b>LED</b> <b>LED</b>					
W	⚡	□	⊙	⚖	📦	⏏	📏
164W	230V	ClI	IP65 IP44 Plug	17kg	280x200x7,5cm	INC.	10x20mm

[GRÁFICOS: Unidades en mm/ GRAPHICS: Units in mm/ GRAPHIQUES: Unités en mm/ GRÁFICOS: Unidades em mm]

# Lilium

## Punta Cono

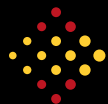

MADE IN SPAIN  
Desing by PRILUX

# Lilium



MADE IN SPAIN  
Desing by PRILUX

**N**  
NEW

Motivo  
Motifs  
Motifs  
Motivos



516327	flexi	LED	Ø78cm 6-8m

36W	230V	CII	IP65 IP44 Plug	4,3kg	83x83x5cm	INC.

516341	flexi	LED	Ø117cm 10-12-14m

54W	230V	CII	IP65 IP44 Plug	6,3kg	122x122x5cm	INC.

N 597364	flexi	LED	Ø200cm 16-18-20m

96W	230V	CII	IP65 IP44 Plug	11,8kg	205x205x5cm	INC.

510141	flexi	LED	Ø78cm

36W	230V	CII	IP65 IP44 Plug	4kg	83x83x5cm	INC.

510165	flexi	LED	Ø117cm

54W	230V	CII	IP65 IP44 Plug	6kg	122x122x5cm	INC.

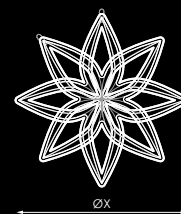
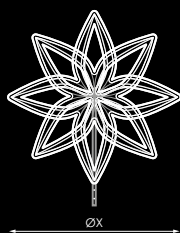











# Reno Double Neon

180cm



					
487511	<b>flexi</b> DOUBLE NEON 				
					
117W	230V	CII	IP54 IP44 Plug	186x116x5cm	INC.

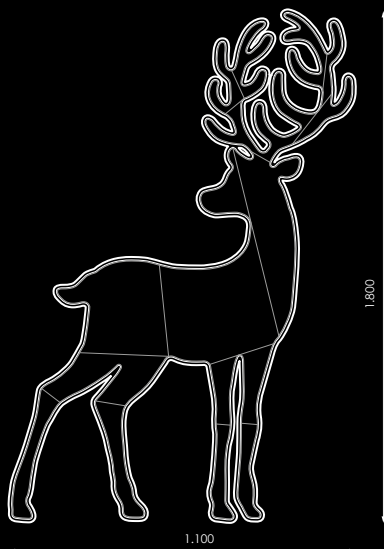

# Reno Double Neon

140cm



					
487528	<b>flexi</b> DOUBLE NEON 				
					
90W	230V	CII	IP54 IP44 Plug	146x90x5cm	INC.

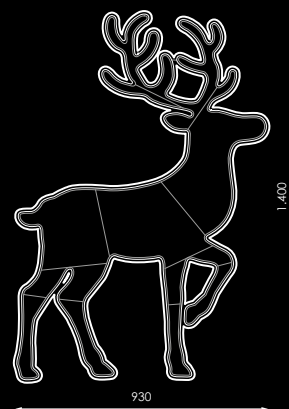





MADE IN SPAIN  
Desing by PRILUX

# Arkaid



MADE IN SPAIN  
Desing by PRILUX

# Gift Box

## Loop II



Motivo  
Motifs  
Motifs  
Motivos



Motivo  
Motifs  
Motifs  
Motivos



A

B

C



	1	2	
415101	A	flexi LED	STRING PLUS LED
488778	B	flexi LED	STRING PLUS LED
W	⚡	□	⊙
44W	230V	CII	IP65 IP44 Plug
		kg	kg
			120x120x5cm
			INC.

	1	2	
442930	A	flexi LED	STRING PLUS LED
442947	B	flexi LED	STRING PLUS LED
442954	C	flexi LED	STRING PLUS LED
W	⚡	□	⊙
97W	230V	CII	IP65 IP44 Plug
		kg	kg
			153x190x5cm
			INC.
			10mm

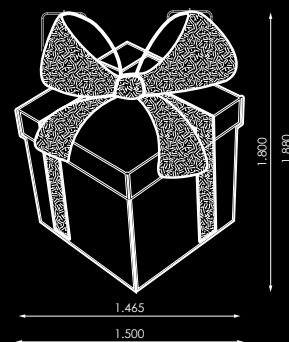
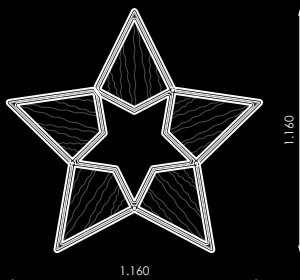

[GRÁFICOS: Unidades en mm/ GRAPHICS: Units in mm/ GRÁFICOS: Unidades en mm/ GRAPHICS: Units in mm/ GRÁFICOS: Unidades en mm/ GRAPHICS: Units in mm]

# Gift I



MADE IN SPAIN  
Desing by PRILUX

# Star Flake



MADE IN SPAIN  
Desing by PRILUX

Motivo  
Motifs  
Motifs  
Motivos

Motivo  
Motifs  
Motifs  
Motivos

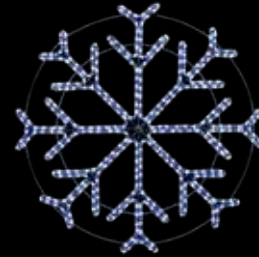

A

B

C



A

B

C



194037	A	flexi LED  Ø80cm				
194013	B	flexi LED  Ø80cm				
194044	C	flexi LED  Ø80cm				
W						
33W	230V	CII	IP65 IP44 Plug	2,5kg	83x83x5cm	INC.

375726	A	flexi LED  LED	STRING PLUS  LED	TAPIZ			
375696	B	flexi LED  LED	STRING PLUS  LED	TAPIZ			
375733	C	flexi LED  LED	STRING PLUS  LED	TAPIZ			
W							
63W	230V	CII	IP65 IP44 Plug	8,5kg	120x120x5cm	INC.	10mm

194068	A	flexi LED  Ø120cm				
194051	B	flexi LED  Ø120cm				
194075	C	flexi LED  Ø120cm				
W						
51W	230V	CII	IP65 IP44 Plug	4,5kg	123x123x5cm	INC.

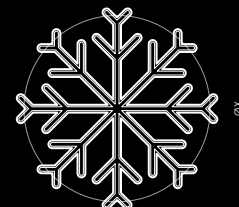
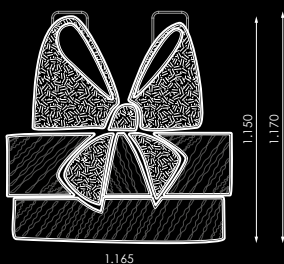



MADE IN SPAIN  
Desing by PRILUX

# Wake

# Tulip



Motivo  
Motifs  
Motifs  
Motivos



Motivo  
Motifs  
Motifs  
Motivos

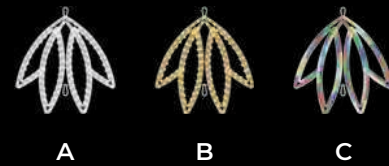

				W
510363	A			15W
510370	B			15W
510387	C			23W

  

230V	CII	IP65 IP44 Plug	1,7kg	57x57x5cm	INC.

				W
510394	A			18W
510400	B			18W
510417	C			28W

230V	CII	IP65 IP44 Plug	1,7kg	55x55x5cm	INC.

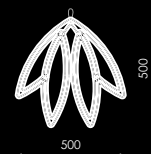
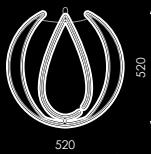

# Fly



MADE IN SPAIN  
Desing by PRILUX

# Tear



MADE IN SPAIN  
Desing by PRILUX

Motivo  
Motifs  
Motifs  
Motivos



Motivo  
Motifs  
Motifs  
Motivos



A B C



A B C



	1	2	W
510424	A	flexi LED	24W
510431	B	flexi LED	24W
510448	C	flexi LED	46W

		W
510455	A	flexi LED 9W
510462	B	flexi LED 9W
510479	C	flexi LED 14W

230V	CII	IP65 IP44 Plug	2,1kg	58x68x5cm	INC.

230V	CII	IP65 IP44 Plug	1kg	55x45x5cm	INC.

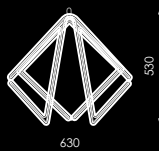



# Star Mini Double

# Star Mini Double Neon

Motivo  
Motifs  
Motifs  
Motivos

Motivo  
Motifs  
Motifs  
Motivos



	1	2	
412759	A	flexi LED	Ø30cm
412766	B	flexi LED	Ø30cm
412773	C	flexi LED	Ø30cm

5,9W	230V	CII	IP65 IP44 Plug	1kg	35x35x5cm	INC.
------	------	-----	-------------------	-----	-----------	------

	1	2	
412810	A	flexi LED	Ø60cm
412827	B	flexi LED	Ø60cm
412834	C	flexi LED	Ø60cm

11,2W	230V	CII	IP65 IP44 Plug	1,5kg	65x65x5cm	INC.
-------	------	-----	-------------------	-------	-----------	------

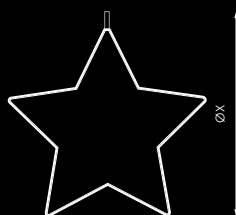

486217	A	flexi DOUBLE NEON LED
489195	B	flexi DOUBLE NEON LED
489201	C	flexi DOUBLE NEON LED
489188	D	flexi DOUBLE NEON LED

18W	230V	CII	IP65 IP44 Plug	1kg	53x53x5cm	INC.
-----	------	-----	-------------------	-----	-----------	------



# Double Star Flashing



MADE IN SPAIN  
Desing by PRILUX

# Sphere Mini 2D



MADE IN SPAIN  
Desing by PRILUX

Motivo  
Motifs  
Motifs  
Motivos



Motivo  
Motifs  
Motifs  
Motivos

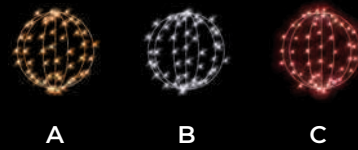
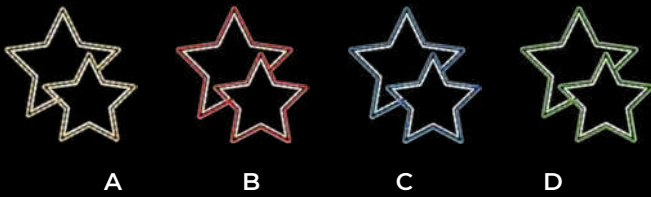

		1	2
412865	A	flexi LED	flexi LED LED
412872	B	flexi LED	flexi LED LED
412889	C	flexi LED	flexi LED LED
412896	D	flexi LED	flexi LED LED

W	⚡	□	⊙	⚖	📦	🔌
18W	230V	CII	IP65 IP44 Plug	1kg	35x35x5cm	INC.

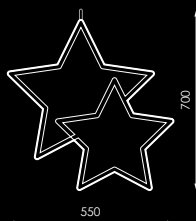

		□
416078	A	STRING PLUS LED LED
416061	B	STRING PLUS LED LED
497374	C	STRING PLUS LED LED

  

W	⚡	□	⊙	⚖	📦	🔌
3W	230V	CII	IP65 IP44 Plug	1kg	50x50x5cm	INC.

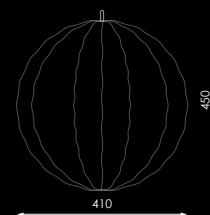

# Alpha con Movimiento

Motivo  
Motifs  
Motifs  
Motivos

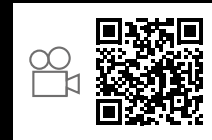
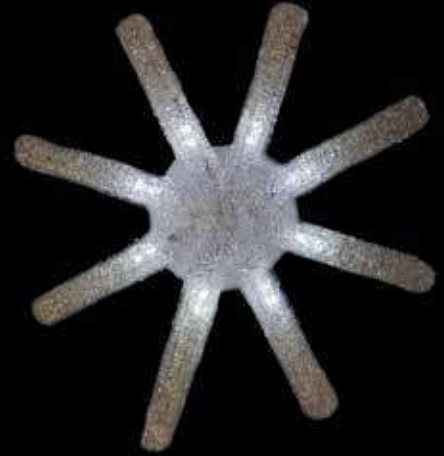
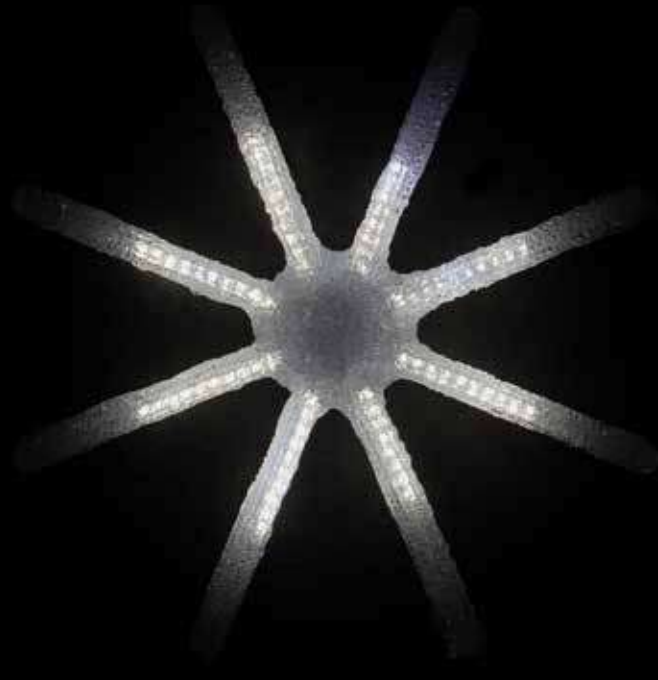

566865						
<b>W</b>						
7W	230V	CII	IP65	1kg	43,5x43x4cm	NO INC.

566858						
<b>W</b>						
2,5W	230V	CII	IP65	0,7kg	28x28x4cm	NO INC.

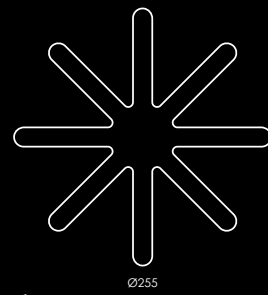
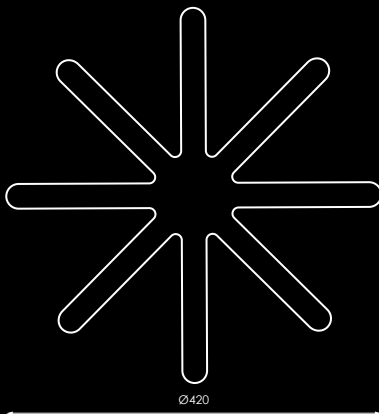

Accesorios (NO Incluidos) / Accessoires (NOT Included) / Accessories (NON Inclus) / Acessórios (NÃO Incluso)



193078

Cable Alimentación Sin Rectificador

# Red Loop

# Gold Star

Pmma



566452	<b>flexi</b> <b>LED</b>	STRING <b>PLUS</b> <b>LED</b>				
<b>W</b>						
9W	230V	CII	IP65 IP44 Plug	2,3kg	55x50x5cm	INC.

566445	<b>flexi</b> <b>LED</b> <b>LED</b>	PMMA				
<b>W</b>						
13W	230V	CII	IP65 IP44 Plug	5kg	75x72x5cm	INC.

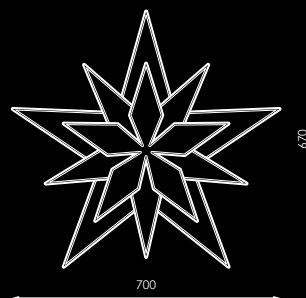
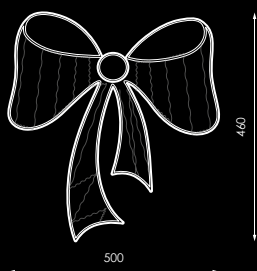



# Star 8 puntas

## Pmma



# Star 8 puntas

## Doble



[GRÁFICOS: Unidades en mm/ GRAPHICS: Units in mm/ GRÁFICOS: Unidades en mm/ GRAPHICS: Units in mm/ GRÁFICOS: Unidades en mm]



442626		PMMA				
442633		PMMA				
<b>W</b>						
12W	230V	CII	IP65 IP44 Plug	2kg	44x54x3,5cm	INC.

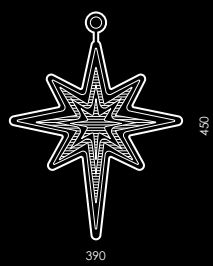

442664		PMMA				
442664		PMMA				
<b>W</b>						
11W	230V	CII	IP65 IP44 Plug	2kg	76x98x3,5cm	INC.

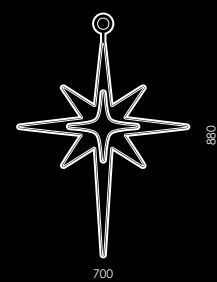

# Ball Mini

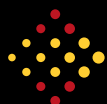

MADE IN SPAIN  
Desing by PRILUX

Motivo  
Motifs  
Motifs  
Motivos



A



B



C



194204

A

flexiLED

194211

B

flexiLED

194242

C

flexiLED

W



16W

230V

CII

IP65  
IP44 Plug

1kg

53x53x5cm

INC.

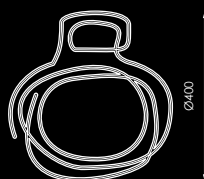

# Mini Snow

# Star Flake Mini

Motivo  
Motifs  
Motifs  
Motivos

Motivo  
Motifs  
Motifs  
Motivos

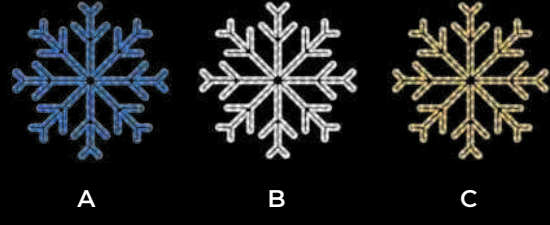
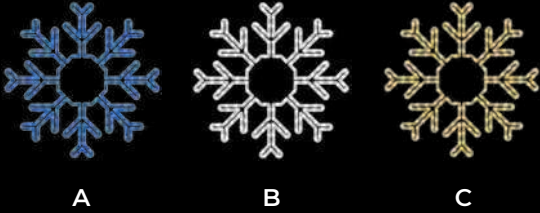

194457	A					
194426	B					
194433	C					
<b>flexiLED</b>						
15W	230V	CII	IP65 IP44 Plug	2kg	55x55x3cm	INC.

195164	A					
195171	B					
195188	C					
<b>flexiLED</b>						
15W	230V	CII	IP65 IP44 Plug	2kg	55x55x3cm	INC.

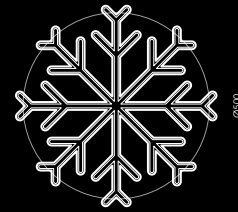
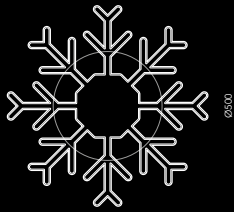

[GRÁFICOS: Unidades en mm/ GRÁFICOS: Units in mm/ GRAPHIQUES: Unités en mm/ GRÁFICOS: Unidades em mm]



L'Alcudia  
València

# Ring Ribbon

Motivo  
Motifs  
Motifs  
Motivos



A



B



Barcode	Model	Product Name	LED	Dimensions
487535	A	flexi DOUBLE NEON	LED	Ø32cm
487542	B	flexi DOUBLE NEON	LED	Ø32cm

W	V	Class	IP	Weight	Dimensions	INC.
9W	230V	CII	IP20	1kg	35x35x5cm	6m

Barcode	Model	Product Name	LED	Dimensions
487559	A	flexi DOUBLE NEON	LED	Ø64cm
487566	B	flexi DOUBLE NEON	LED	Ø64cm

W	V	Class	IP	Weight	Dimensions	INC.
18W	230V	CII	IP20	2kg	67x67x5cm	6m

Barcode	Model	Product Name	LED	Dimensions
487573	A	flexi DOUBLE NEON	LED	Ø95,5cm
487580	B	flexi DOUBLE NEON	LED	Ø95,5cm

W	V	Class	IP	Weight	Dimensions	INC.
27W	230V	CII	IP20	3kg	99x99x5cm	6m

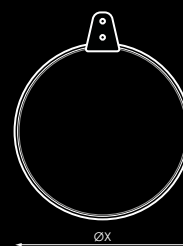

## Aviso / Warning / Avertissement / Aviso

Ñ/ Para colocar este producto en el exterior, se necesita el cable de alimentación IP44.

E/ To place this product outdoors, the IP44 power cable is required.

F/ Pour placer ce produit à l'extérieur, le câble d'alimentation IP44 est requis.

P/ Para colocar este produto ao ar livre, é necessário o cabo de alimentação IP44.

## Bajo pedido / On request / Sur commande / A pedido



Cable alimentación IP44



# Accesorios

Accessories

Accessoires

Acessórios

PIE VERTICAL

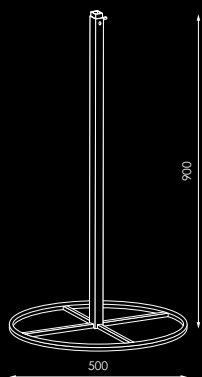

480826



Aluminio



95-165cm

BOLSAS BRIDAS

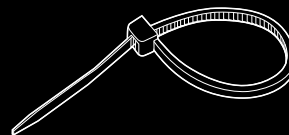

600118



Blanco



2,5x100mm



100ud

600125



Blanco

3,5x140mm

100ud

600132



Blanco

3,6x200mm

100ud

600149



Blanco

4,8x300mm

100ud

Filtro UV de protección/ UV protection filter/ Filtre anti-UV/ Filtro de proteção UV

CORREA AMARRE CON CIERRE

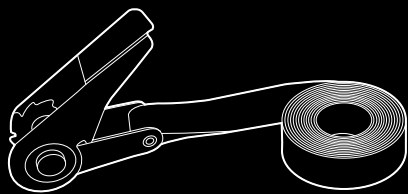

600156



Gris



1m

FIJACIÓN A POSTE 20-25MM

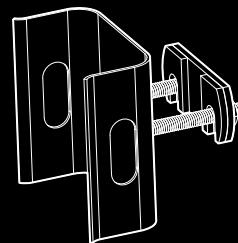

600194

Con goma protectora

BRAZO PARA MOTIVOS CALLE/FACHADA/MINI

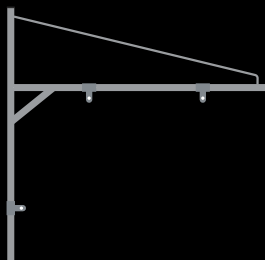

600163



30-60cm



90x90cm

600170

60-120cm

130x130cm

NIVELADOR

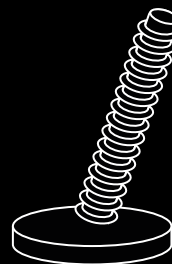

521000

[GRÁFICOS: Unidades en mm/ GRAPHICS: Units in mm/ GRAPHIQUES: Unités en mm/ GRÁFICOS: Unidades em mm]

# Cone String



MADE IN SPAIN  
Desing by PRILUX

Motivo  
Motifs  
Motifs  
Motivos

3D



A



B



C



D



E



Ø50x150cm

				W
444804	A	STRING PLUS LED	LED	18W
444811	B	STRING PLUS LED	LED	18W
444828	C	STRING PLUS LED	LED	18W
488891	D	STRING PLUS LED	LED	28W
510547	E	STRING PLUS LED	LED	28W

24V	CIII	IP65 IP44 Plug	5kg	155x52x52cm	INC.

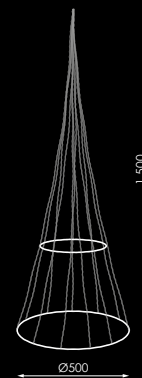

Ø100x250cm

				W
416085	A	STRING PLUS LED	LED	36W
444903	B	STRING PLUS LED	LED	36W
488892	D	STRING PLUS LED	LED	46W
510561	E	STRING PLUS LED	LED	46W

24V	CIII	IP65 IP44 Plug	9kg	255x105x105cm	INC.

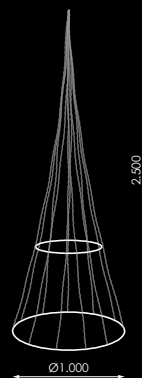



MADE IN SPAIN  
Desing by PRILUX

# Cone Loop

3D Motivo  
Motifs  
Motifs  
Motivos

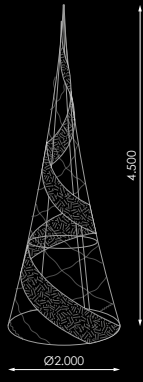
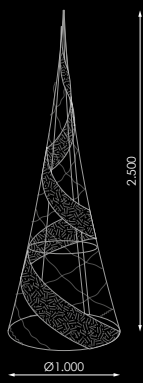
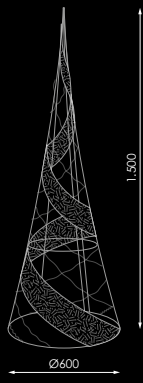
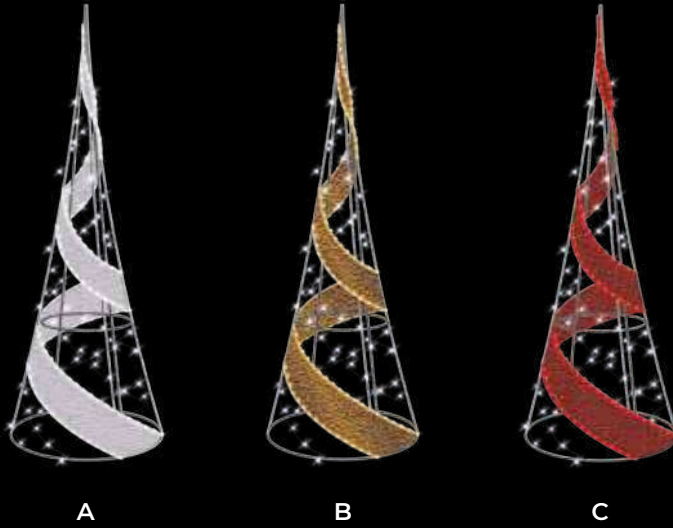

Ø60x150cm						
		1	2			
444651	A	flexi LED	STRING PLUS LED	TAPIZ		
444668	B	flexi LED	STRING PLUS LED	TAPIZ		
444675	C	flexi LED	STRING PLUS LED	TAPIZ		
W	⚡	⚡	⚡	⚡	⚡	⚡
21W	24V	CIII	IP65 IP44 Plug	5kg	155x52x52cm	INC.

Ø100x250cm						
		1	2			
444750	A	flexi LED	STRING PLUS LED	TAPIZ		
444767	B	flexi LED	STRING PLUS LED	TAPIZ		
444774	C	flexi LED	STRING PLUS LED	TAPIZ		
W	⚡	⚡	⚡	⚡	⚡	⚡
48W	24V	CIII	IP65 IP44 Plug	15kg	255x105x105cm	INC.

Ø200x450cm						
		1	2			
545655	A	flexi LED	STRING PLUS LED	TAPIZ		
545662	B	flexi LED	STRING PLUS LED	TAPIZ		
545679	C	flexi LED	STRING PLUS LED	TAPIZ		
W	⚡	⚡	⚡	⚡	⚡	⚡
140W	24V	CIII	IP65 IP44 Plug	35kg	1- 255x52x52cm 1- 205x205x205cm	INC.

[GRÁFICOS: Unidades en mm/ GRAPHICS: Units in mm/ GRAPHIQUES: Unités en mm/ GRÁFICOS: Unidades em mm]

# Cone Loop

## PVC NET



MADE IN SPAIN  
Desing by PRILUX

Motivo  
Motifs  
Motifs  
Motivos

3D

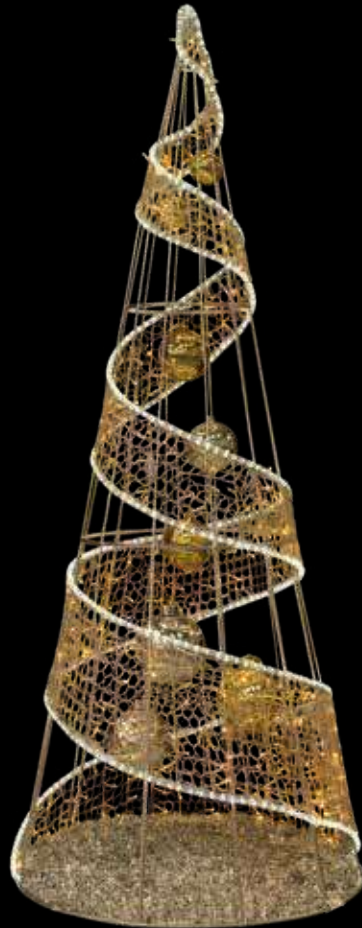

512237	flexiLED	STRING PLUS	PVC NET	CHRISTMAS BALL		
W						
56W	24V	CIII	IP65 IP44 PLUG	15kg	255x105x105cm	INC.

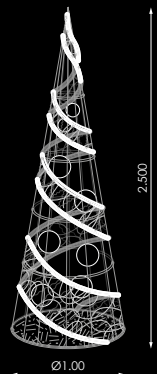





Vega de San Mateo  
Gran Canarias

# Cherry Blossom Tree

1,8m

Motivo  
Motifs  
Motifs  
Motivos

3D



Barcode		Light Bulb	
210461		LED	
210478		LED	
210485		LED	
506281		LED	
W	⚡	⬡	⊕
60W	24V	CIII	IP44
			800
			INC.

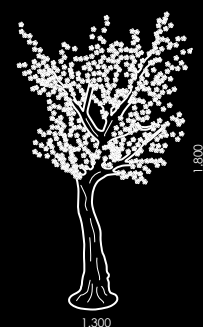



# Cherry Blossom Tree

2,8m

3D Motivo  
Motifs  
Motifs  
Motivos

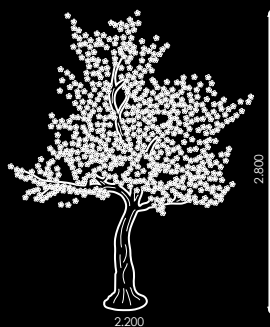

	210492				
	210508				
	210515				
	506298				
<b>W</b>					
150W	24V	CIII	IP44	2120	INC.

# Cherry Blossom Tree

3,6m

Motivo  
Motifs  
Motifs  
Motivos

3D



408226					
408233					
408240					
<b>W</b>					
300W	24V	CIII	IP44	4100	INC.

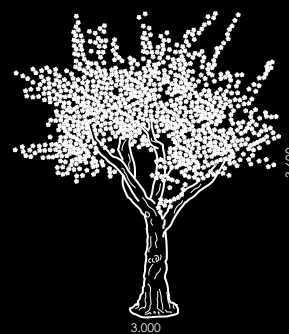



# Cherry Blossom Tree

4,5m

3D

Motivo  
Motifs  
Motifs  
Motivos

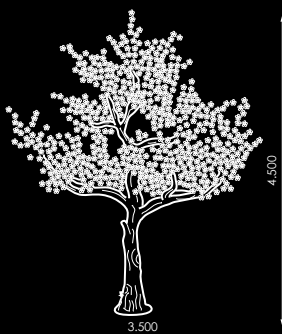

	408257				
	408264				
	408271				
<b>W</b>					
350W	24V	CIII	IP44	5200	INC.







La Almazara  
Ayto. Illescas Toledo

# Maple Tree

Motivo  
Motifs  
Motifs  
Motivos

3D



2,8m					
506311					
506328					
W					
100W	24V	CIII	IP44	1376	INC.

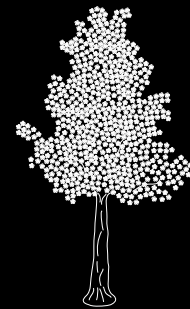

2,800

5m					
506335					
506342					
W					
180W	24V	CIII	IP44	2924	INC.

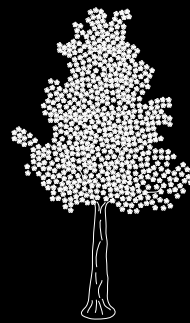

5,000

8m					
506359					
506397					
W					
250W	24V	CIII	IP44	4000	INC.

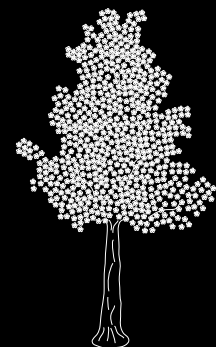

8,000



# Autumn Tree

## 3,5m

3D  
 Motivo  
 Motifs  
 Motifs  
 Motivos



	506434				
	506441				
<b>W</b>					
100W	24V	CIII	IP44	1664	INC.

### Información / Information / Information / Informações

Ñ/ El código 506434 va con hoja blanca y el código 506441 va con hoja otoñal.

E/ Code 506434 goes with a white sheet and code 506441 goes with an autumn leaf.

F/ Le code 506434 va avec une feuille blanche et le code 506441 va avec une feuille d'automne.

P/ EO código 506434 acompanha uma folha em branco e o código 506441 acompanha uma folha de outono.



# Valley Tree

Motivo  
Motifs  
Motifs  
Motivos

3D

N

NEW



547796					
W					
12W	24V	CIII	IP44	400	INC.

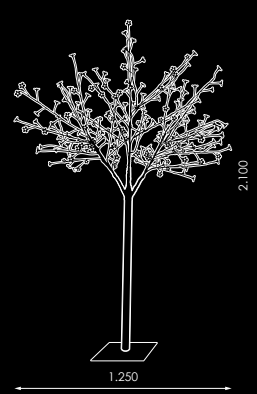

N 601498					
N 601504					
W					
6W	24V	CIII	IP44	600	INC.

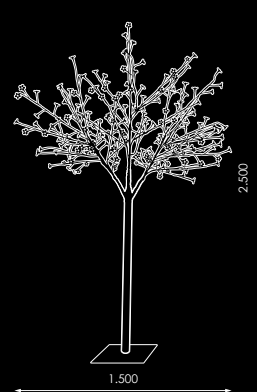

# Giant Tree

3D  
Motivo  
Motifs  
Motifs  
Motivos



CC. Plaza Norte  
Madrid

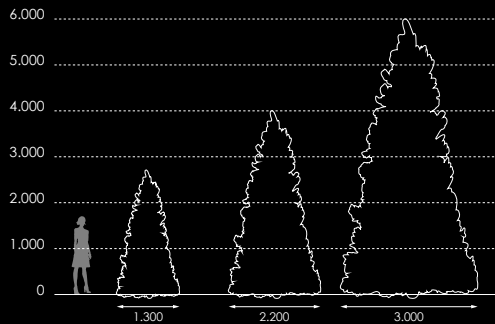

Barcode	Dimensions	Weight	Quantity
412216	2,7m	30kg	1
506946	4m	44kg	2
506991	6m	112kg	4

## Componentes/Components/Composants/Componentes

Ñ/ Estructura de poste interior y base fijación de seguridad.

E/ Structure of inner pole and base with safety locking.

F/ Structure du pôle interne et base avec fermeture de sécurité.

P/ Estrutura do pólo interior e base com bloqueio de segurança.

## Información / Information / Information / Informações

Ñ/ Este producto se sirve desmontado, embalado en el número de cajas que indica la columna de embalaje. Solo se sirve el árbol, sin decoración.

E/ This product is disassembled, packed in the number of cases indicating the column packing. Only the tree is served, without decoration.

F/ Ce produit est démonté, emballé dans le nombre de cas, indiquant l'emballage de la colonne. Seul l'arbre est servi, sans décoration.

P/ Este produto é desmontado, embalado no número de casos, indicando a embalagem de coluna. Somente a árvore é servida, sem decoração.



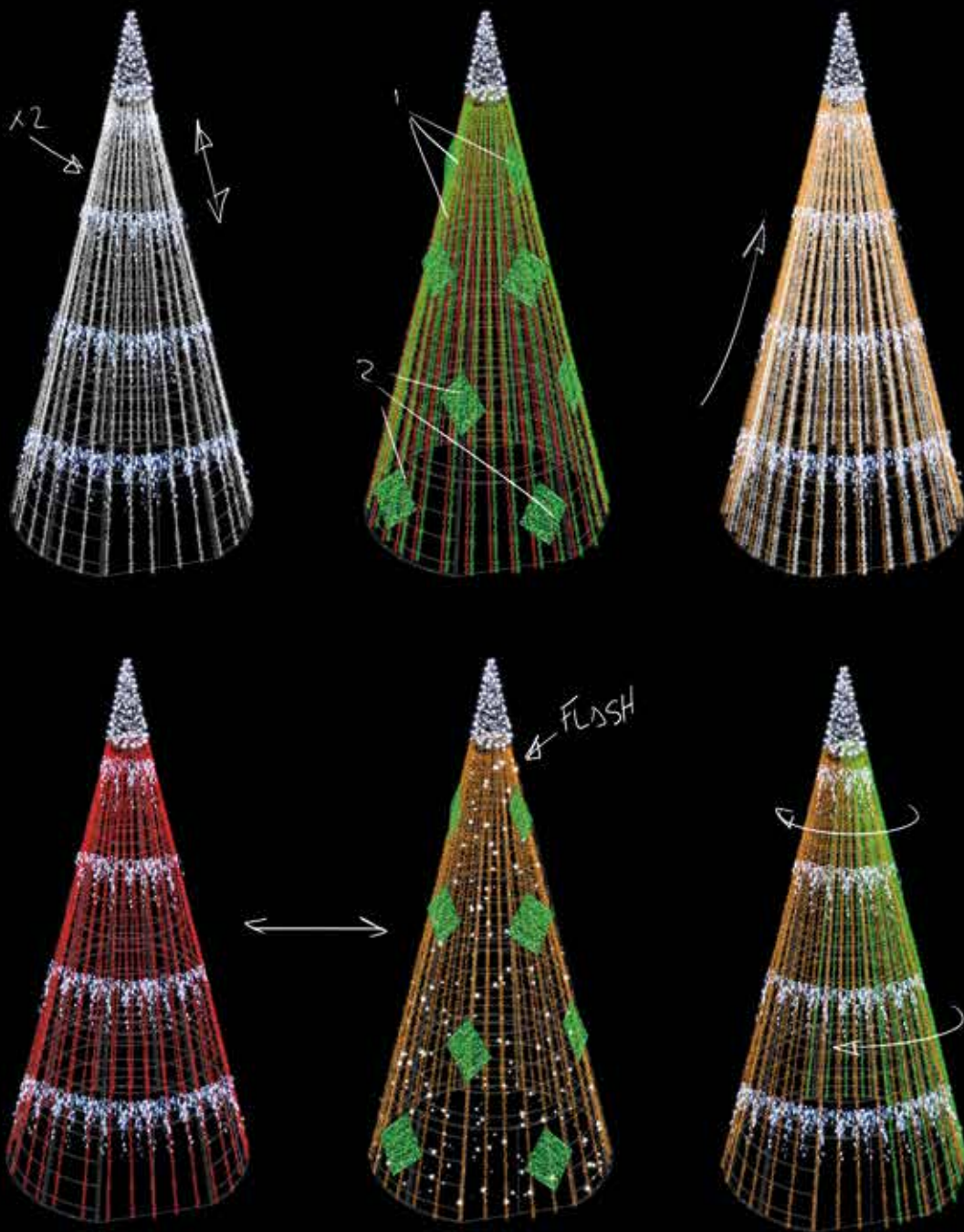

# eConcept

El nuevo sistema de control de iluminación dinámica "prilux econcept" para árboles, fachadas y elementos 3d sincroniza música y luz para crear composiciones visuales espectaculares que aportan ritmo y movimiento a todo tipo de ambientes, espacios y eventos.

"Prilux econcept" The new dynamic lighting control system for trees, facades and 3d elements synchronizes music and light to create spectacular visual compositions that bring rhythm and movement to all types of environments, spaces and events.

"Prilux econcept" Le nouveau système de contrôle d'éclairage dynamique pour arbres, façades et éléments 3D synchronise la musique et la lumière pour créer des compositions visuelles spectaculaires qui apportent du rythme et du mouvement à tous types d'environnements, d'espaces et d'événements.

"Prilux econcept" O novo sistema dinâmico de controle de iluminação para árvores, fachadas e elementos tridimensionais sincroniza música e luz para criar composições visuais espetaculares que trazem ritmo e movimento a todos os tipos de ambientes, espaços e eventos.









# Giant Cone

## PIXELMAX



MADE IN SPAIN  
Desing by PRILUX

Motivo  
Motifs  
Motifs  
Motivos

3D

N

NEW



PIXELMAX



Gavá  
Barcelona

## NO TRANSITABLE

							
567374	4,965m	STRING PIXELMAX		12V	1.030W	135kg	SI
489751	6,945m	STRING PIXELMAX		12V	1.560W	190kg	SI
489768	8,93m	STRING PIXELMAX		12V	2.520W	280kg	SI
489775	10,92m	STRING PIXELMAX		12V	3.720W	420kg	SI
489782	12,91m	STRING PIXELMAX		12V	5.160W	585kg	SI
N 600415	14,90m	STRING PIXELMAX		12V	6.600W	803kg	SI

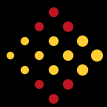

MADE IN SPAIN  
Desing by PRILUX

# Giant Cone PIXELMAX

N  
NEW

3D  
Motivo  
Motifs  
Motivos



PIXELMAX

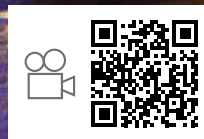

Gijón

## TRANSITABLE

							
567381	6,945m	STRING PIXELMAX		12V	1.440W	185kg	SI
567398	8,93m	STRING PIXELMAX		12V	2.400W	275kg	SI
567404	10,92m	STRING PIXELMAX		12V	3.600W	415kg	SI
567411	12,91m	STRING PIXELMAX		12V	5.040W	580kg	SI
<b>N 600422</b>	14,9m	STRING PIXELMAX		12V	6.590W	795kg	SI
567428	20,9m	STRING PIXELMAX		12V	12.500W	1.436kg	SI

[GRÁFICOS: Unidades en mm/ GRÁFICOS: Units in mm/ GRAPHIQUES: Unités en mm/ GRÁFICOS: Unidades em mm]



# Giant Cone

## PIXELMAX Rings



MADE IN SPAIN  
Desing by PRILUX

Motivo  
Motifs  
Motifs  
Motivos

3D



PIXELMAX

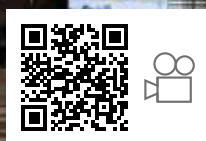

C.C. La Gavia  
Madrid

		+ LILIUM				W		
567435	8,33m	9,11m	STRING PIXELMAX		12V/230V	1.600W	275kg	SI
567442	10,32m	11,49m	STRING PIXELMAX		12V/230V	2.075W	415kg	SI
567459	12,31m	13,48m	STRING PIXELMAX		12V/230V	3.765W	580kg	SI

### Aviso / Warning / Avertissement / Aviso

Ñ/ Sólo será transitable el modelo de 12m.

E/ Only the 12m model will be passable.

F/ Seul le modèle 12m sera praticable.

P/ Apenas o modelo de 12m será transitável.





MADE IN SPAIN  
Desing by PRILUX

# Giant Cone

## RGB (sin recubrimiento)

3D Motivo  
Motifs  
Motifs  
Motivos

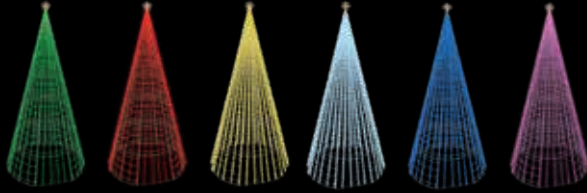
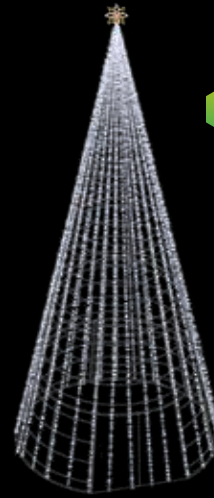

Opción de composición/ Composition option  
Option de composition/ Opção de composição

	↔	↔ + LILIUM	💡	⚡	W	👤	🕒
489799	6,34m	7,12m	STRING PLUS LED	230V	250W	141kg	NO
489805	8,33m	9,11m	STRING PLUS LED	230V	405W	200kg	NO
489812	10,32m	11,49m	STRING PLUS LED	230V	625W	315kg	NO
489829	12,31m	13,48m	STRING PLUS LED	230V	780W	460kg	NO



MADE IN SPAIN  
Desing by PRILUX

# Giant Cone

## RGB (sin recubrimiento)

NEW

3D Motivo  
Motifs  
Motifs  
Motivos

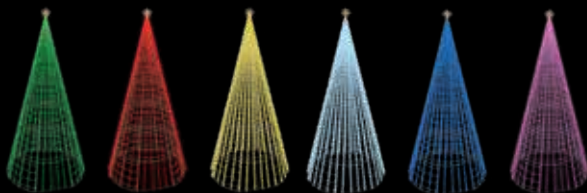
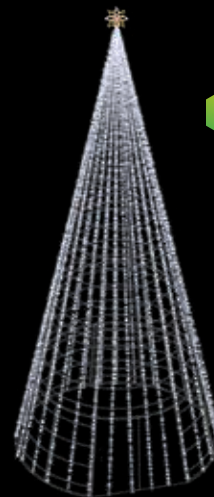

Opción de composición/ Composition option  
Option de composition/ Opção de composição

	↔	↔ + LILIUM	💡	⚡	W	👤	🕒
600439	6,34m	7,12m	STRING PLUS LED	230V	432W	129kg	SI
600446	8,33m	9,11m	STRING PLUS LED	230V	652W	205kg	SI
600453	10,32m	11,49m	STRING PLUS LED	230V	937W	345kg	SI
600460	12,31m	13,48m	STRING PLUS LED	230V	1250W	500kg	SI

[GRÁFICOS: Unidades en mm/ GRÁFICOS: Units in mm/ GRÁFICOS: Unidades em mm/ GRÁFICOS: Unidades em mm]

# Giant Cone

## CW-WW (sin recubrimiento)

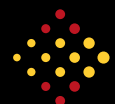

MADE IN SPAIN  
Desing by PRILUX

Motivo  
Motifs  
Motifs  
Motivos

3D

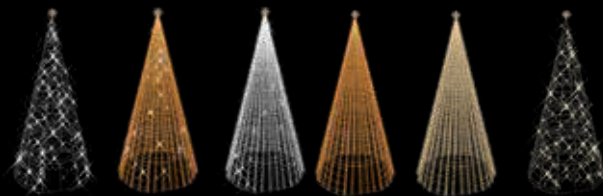
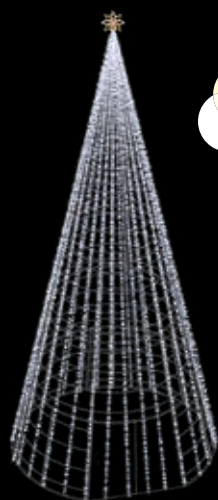

Opción de composición/ Composition option  
Option de composition/ Opção de composição



Icon	↕	↕ + LILIUM	💡	⚡	W	👤	🕒
511612	6,34m	7,12m	STRING PLUS LED	230V	250W	141kg	NO
511629	8,33m	9,11m	STRING PLUS LED	230V	405W	200kg	NO
511636	10,32m	11,49m	STRING PLUS LED	230V	625W	315kg	NO
511643	12,31m	13,48m	STRING PLUS LED	230V	780W	460kg	NO

# Giant Cone

## RGB Double Star (sin recubrimiento)

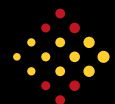

MADE IN SPAIN  
Desing by PRILUX

Motivo  
Motifs  
Motifs  
Motivos

3D



Opción de composición/ Composition option  
Option de composition/ Opção de composição



Icon	↕	↕ + LILIUM	💡	🔧	⚡	W	👤	🕒
511650	8,33m	9,11m	STRING PLUS LED	Double Star	230V	812W	265kg	NO
511667	10,32m	11,49m	STRING PLUS LED	Double Star	230V	1.179W	404kg	NO
511674	12,31m	13,48m	STRING PLUS LED	Double Star	230V	1.537W	610kg	NO

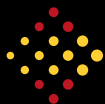

MADE IN SPAIN  
Desing by PRILUX

# Giant Cone

## Spiral Tapiz Rojo (sin recubrimiento)



		+ LILIUM						
511681	8,33m	9,11m	STRING <b>PLUS</b> <b>LED</b>	TAPIZ ROJO	230V	439W	260kg	NO
511698	10,32m	11,49m	STRING <b>PLUS</b> <b>LED</b>	TAPIZ ROJO	230V	659W	405kg	NO
511704	12,31m	13,48m	STRING <b>PLUS</b> <b>LED</b>	TAPIZ ROJO	230V	813W	610kg	NO

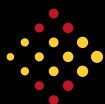

MADE IN SPAIN  
Desing by PRILUX

# Giant Cone

## Spiral Gold (sin recubrimiento)



		+ LILIUM						
511711	8,33m	9,11m	STRING <b>PLUS</b> <b>LED</b>	GUIRNALDA DORADA + LÁMAPARA FLASH	230V	651W	265kg	NO
511766	10,32m	11,49m	STRING <b>PLUS</b> <b>LED</b>	GUIRNALDA DORADA + LÁMAPARA FLASH	230V	947W	415kg	NO
511773	12,31m	13,48m	STRING <b>PLUS</b> <b>LED</b>	GUIRNALDA DORADA + LÁMAPARA FLASH	230V	1233W	625kg	NO

[GRÁFICOS: Unidades en mm/ GRAPHICS: Units in mm/ GRAFIQUES: Unités en mm/ GRÁFICOS: Unidades em mm]

# Giant Cone

String Flashing (sin recubrimiento)



MADE IN SPAIN  
Desing by PRILUX



Motivo  
Motifs  
Motifs  
Motivos

3D

N

NEW



	↕	↕ + LILIUM	💡	⚡	W	📏	🕒
600521	6,34m	7,12m	STRING PLUS  	230V	432W	129kg	SI
600538	8,33m	9,11m	STRING PLUS  	230V	652W	205kg	SI
600545	10,32m	11,49m	STRING PLUS  	230V	934W	329kg	SI
600552	12,31m	13,48m	STRING PLUS  	230V	1.242W	479kg	SI
600569	6,34m	7,12m	STRING PLUS  	230V	432W	129kg	SI
600576	8,33m	9,11m	STRING PLUS  	230V	652W	205kg	SI
600583	10,32m	11,49m	STRING PLUS  	230V	934W	329kg	SI
600590	12,31m	13,48m	STRING PLUS  	230V	1.242W	479kg	SI





MADE IN SPAIN  
Desing by PRILUX

# Giant Cone

## Combo (sin recubrimiento)

**N**  
NEW

**3D** Motivo  
Motifs  
Motifs  
Motivos



[GRÁFICOS: Unidades en mm/ GRAPPHICS: Units in mm/ GRAPHIQUES: Unités en mm/ GRÁFICOS: Unidades em mm]

		+ LILIUM						
600491	10,32m	11,49m	STRING PLUS LED LED	STAR FLAKE + ALPHA + MINI SNOW	230V	1,527W	398kg	SI
600507	14,3m	15,47m	STRING PLUS LED LED	STAR FLAKE + ALPHA + MINI SNOW	230V	2,597W	760kg	SI
600514	18,3m	20,3m	STRING PLUS LED LED	STAR FLAKE + ALPHA + MINI SNOW	230V	3,987W	1,240kg	SI

# Giant Cone

## Star Flake (sin recubrimiento)



MADE IN SPAIN  
Desing by PRILUX

Motivo  
Motifs  
Motifs  
Motivos

3D

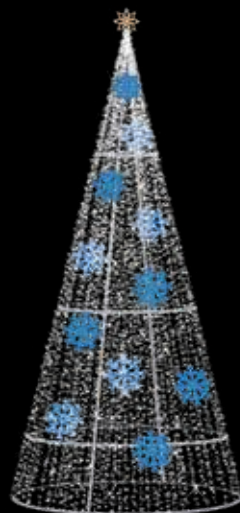

	↕	↕ + LILIUM	💡	⚡	⚡	W	⚖	🕒
453653	8,33m	9,11m	STRING PLUS LED	STAR FLAKE	230V	1.091W	255kg	NO
453721	10,32m	11,49m	STRING PLUS LED	STAR FLAKE	230V	1.291W	370kg	NO
453790	12,31m	13,48m	STRING PLUS LED	STAR FLAKE	230V	1.827W	558kg	NO

# Giant Cone

## Stars (sin recubrimiento)



MADE IN SPAIN  
Desing by PRILUX

Motivo  
Motifs  
Motifs  
Motivos

3D



	↕	↕ + LILIUM	💡	⚡	⚡	W	⚖	🕒
489942	8,33m	9,11m	STRING PLUS LED	21 ESTRELLAS	230V	1.085W	260kg	SI
489959	10,32m	11,49m	STRING PLUS LED	29 ESTRELLAS	230V	1.565W	402kg	SI
467520	12,31m	13,48m	STRING PLUS LED	37 ESTRELLAS	230V	2.005W	591kg	SI



MADE IN SPAIN  
Desing by PRILUX

# Giant Cone Ice (con recubrimiento)

**N**  
NEW

**3D**  
Motivo  
Motifs  
Motifs  
Motivos



Barcode	↕	↕ + LILIUM	💡	🔧	⚡	W	📊 kg	🕒
600477	8,33m	9,11m	STRING PLUS LED	TAPIZ AZUL + STAR FLAKE + ALPHA	230V	1.020W	200kg	SI
600484	10,32m	11,49m	STRING PLUS LED	TAPIZ AZUL + STAR FLAKE + ALPHA	230V	1.478W	460kg	SI



MADE IN SPAIN  
Desing by PRILUX

# Giant Cone Tears (con recubrimiento)

**3D**  
Motivo  
Motifs  
Motifs  
Motivos



Barcode	↕	↕ + LILIUM	💡	🔧	⚡	W	📊 kg	🕒
567466	6,34m	7,12m	STRING PLUS LED	TEARS WW + RED METALLIC BRANCH	230V	558W	208kg	NO
567473	8,33m	9,11m	STRING PLUS LED	TEARS WW + RED METALLIC BRANCH	230V	838W	361kg	NO
567480	10,32m	11,49m	STRING PLUS LED	TEARS WW + RED METALLIC BRANCH	230V	1.212W	534kg	NO

[GRÁFICOS: Unidades en mm / GRAPHICS: Units in mm / GRÁFICOS: Unidades em mm / GRÁFICOS: Unidades em mm]

# Basic Gift Box



MADE IN SPAIN  
Desing by PRILUX

Motivo  
Motifs  
Motifs  
Motivos

3D



PIXELMAX

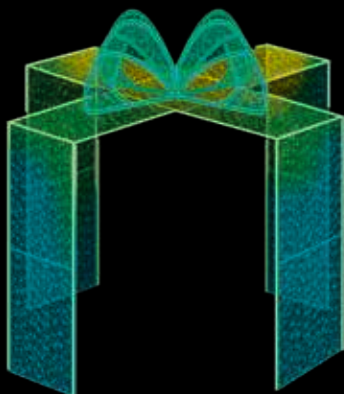

Icon	Icon	Icon	Icon	Icon	W	Icon
565134	3,4x3,4x3,4m	STRING PIXELMAX	LED	12V	1.800W	150kg
565127	3,4x3,4x3,4m	STRING PLUS	STRING PLUS LED	24V	240W	130kg
565141	3,4x3,4x3,4m	STRING PLUS	STRING PLUS LED	24V	240W	130kg

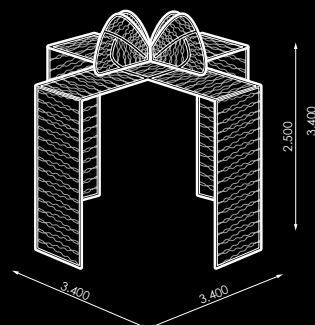





MADE IN SPAIN  
Desing by PRILUX

# Big Gift Box

3D  
Motivo  
Motifs  
Motifs  
Motivos



Valsequillo  
Gran Canarias

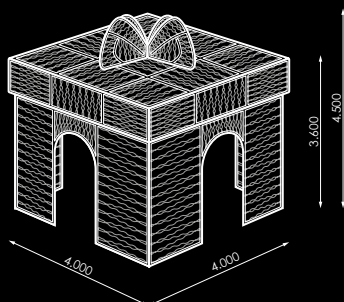
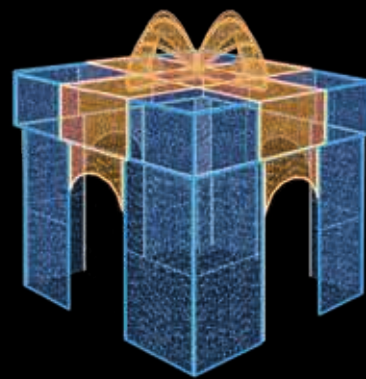
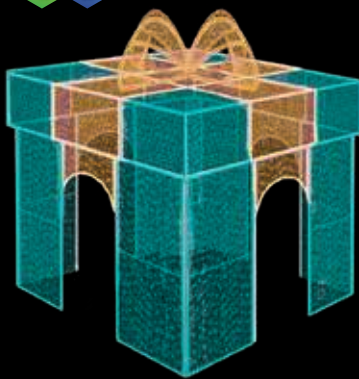
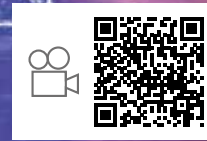

565240	4x4x4,5m	STRING PLUS	RGB (LAZO WW)	24V	800W	340kg
565226	4x4x4,5m	STRING PLUS FLASHING	BLUE (LAZO WW)	24V	720W	320kg

[GRÁFICOS: Unidades en mm/ GRAPHICS: Units in mm/ GRAPHIQUES: Unités en mm/ GRÁFICOS: Unidades em mm]

# Basic Gift

## Box Cerrada



MADE IN SPAIN  
Desing by PRILUX

Motivo  
Motifs  
Motifs  
Motivos

3D

N

NEW

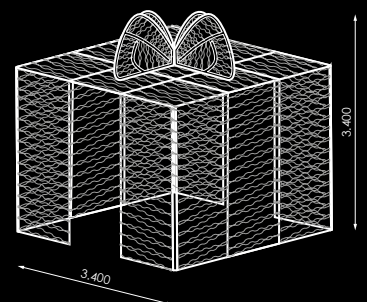
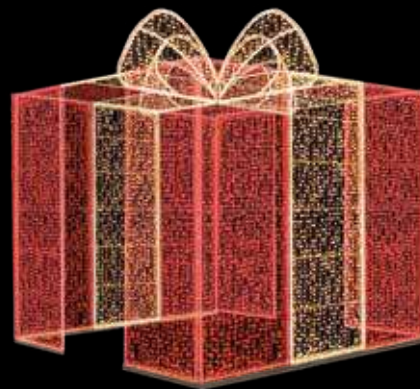
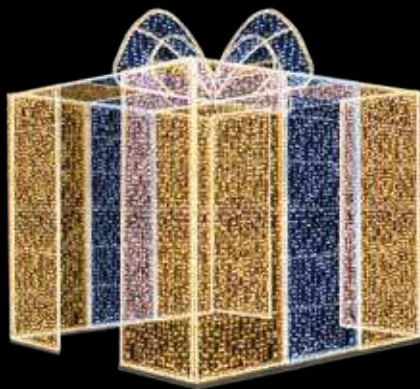

			1	2	⚡	W	⚖️
600279	3,4x3,4x3,4m	flexi LED LED	STRING PLUS LED	STRING PLUS LED	24V	650W	260kg
600286	3,4x3,4x3,4m	flexi LED LED	STRING PLUS LED	STRING PLUS LED	24V	650W	260kg





MADE IN SPAIN  
Desing by PRILUX

# Giant Ball

6m

**N**  
NEW

**3D** Motivo  
Motifs  
Motifs  
Motivos



PIXELMAX

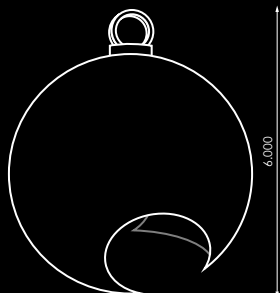

600293	6m	STRING PIXELMAX	flexiLED	LED	12V/24V	5,700W	480kg
600309	6m	STRING PLUS	flexiLED	STRING PLUS LED	24V	1,110W	450kg
600316	6m	STRING PLUS	flexiLED	STRING PLUS LED	24V	930W	450kg

[GRÁFICOS: Unidades en mm/ GRAPHICS: Units in mm/GRÁFICOS: Unidades en mm/GRÁFICOS: Unidades en mm]

# Giant Ball

## PIXELMAX



MADE IN SPAIN  
Desing by PRILUX

Motivo  
Motifs  
Motifs  
Motivos

3D



567503	2,8x2,6m	STRING PIXELMAX	flexiLED	LED	12V/24V	1.570W	127kg

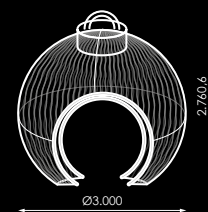

567497	4,3x4m	STRING PIXELMAX	flexiLED	LED	12V/24V	2.700W	196kg

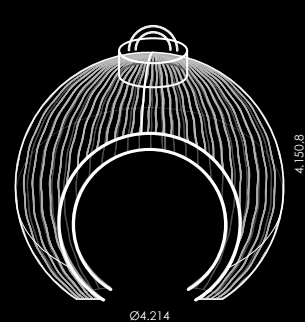





MADE IN SPAIN  
Desing by PRILUX

# Giant Ball Stars

3D Motivo  
Motifs  
Motifs  
Motivos



Guadalupe  
Cáceres

[GRÁFICOS: Unidades en mm/ GRAPHICS: Units in mm/ GRAPHIQUES: Unités en mm/ GRÁFICOS: Unidades en mm]

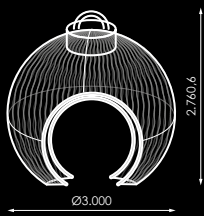

	↕	⚙️	□	■	⚡	W	⚖️
567527	2,8x2,6m	STRING PLUS FLASHING	flexi LED	STRING PLUS LED	24V	210W	105kg
567541	2,8x2,6m	STRING PLUS FLASHING	flexi LED	STRING PLUS LED	24V	210W	105kg

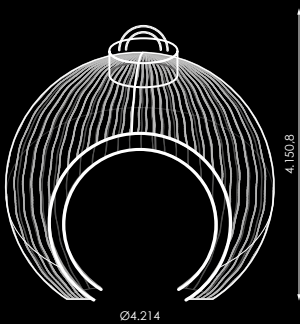

	↕	⚙️	□	■	⚡	W	⚖️
567510	4,3x4m	STRING PLUS FLASHING	flexi LED	STRING PLUS LED	24V	375W	178kg
567534	4,3x4m	STRING PLUS FLASHING	flexi LED	STRING PLUS LED	24V	375W	178kg

# Trono Real Selfie



MADE IN SPAIN  
Desing by PRILUX

Motivo  
Motifs  
Motifs  
Motivos

3D

N

NEW



600392	flexi LED	TAPIZ	STRING PLUS LED		
160W	24V	CIII	IP65 IP44 Plug	59kg	INC.

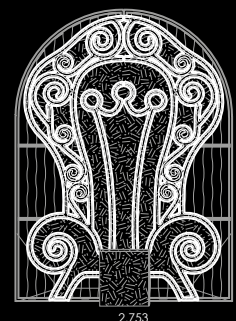

3,011

2,753





MADE IN SPAIN  
Desing by PRILUX

# Jengibre Selfie



**N**  
NEW

**3D**  
Motivo  
Motifs  
Motifs  
Motivos

[GRÁFICOS: Unidades en mm/ GRAPHICS: Units in mm/ GRAPHIQUES: Unités en mm/ GRÁFICOS: Unidades em mm]



600408	flexi		TAPIZ	STRING
140W	24V	CIII	IP65 IP44 Plug	46kg
				INC.

# Alas Tinkerbell

Selfie

MADE IN SPAIN  
Desing by PRILUX

Motivo  
Motifs  
Motifs  
Motivos

3D



561334	flexi LED	STRING PLUS LED	TAPIZ	STRING PLUS LED	
W					
125W	24V	CIII	IP65 IP44 Plug	40kg	INC.

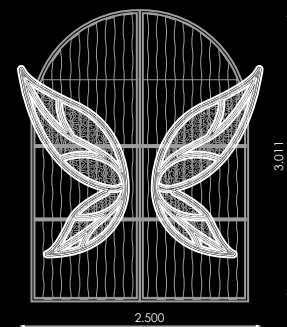

# Penguin

Selfie

MADE IN SPAIN  
Desing by PRILUX

Motivo  
Motifs  
Motifs  
Motivos

3D



562638	flexi LED LED	STRING PLUS LED	TAPIZ	STRING PLUS LED	
W					
160W	24V	CIII	IP65 IP44 Plug	44kg	INC.

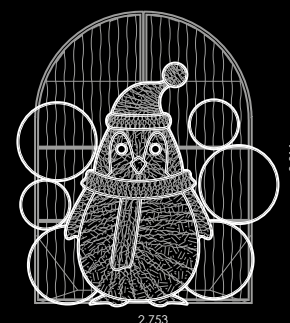





MADE IN SPAIN  
Desing by PRILUX

# Alas Ángel Selfie



3D  
Motivo  
Motifs  
Motifs  
Motivos

Santa Brígida  
Gran Canarias

[GRÁFICOS: Unidades en mm/ GRAPHICS: Units in mm/ GRAPHIQUES: Unités en mm/ GRÁFICOS: Unidades em mm]

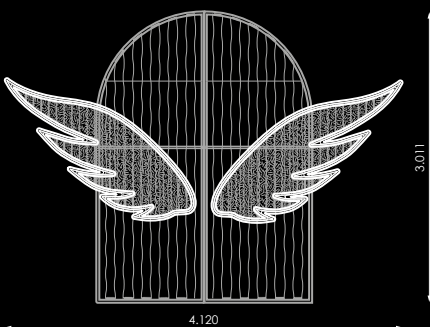

562089	flexiLED	STRING PLUS LED	TAPIZ	STRING PLUS LED
W				
135W	24V	CIII	IP65 IP44 Plug	42kg
				INC.

# Bota Papá Noel

## Selfie

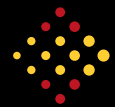

MADE IN SPAIN  
Desing by PRILUX

Motivo  
Motifs  
Motifs  
Motivos

3D

N

NEW



600323	flexi	STRING PLUS		TAPIZ	
W					
164W	24V	CIII	IP65 IP44 Plug	70kg	INC.

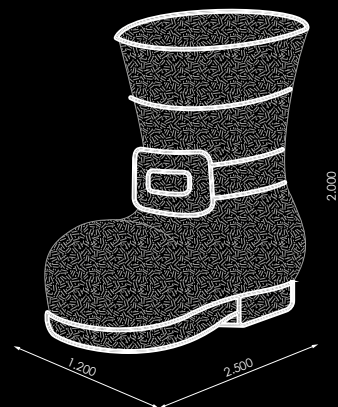

576895	flexi	STRING PLUS		TAPIZ	
W					
690W	24V	CIII	IP65 IP44 Plug	150kg	INC.

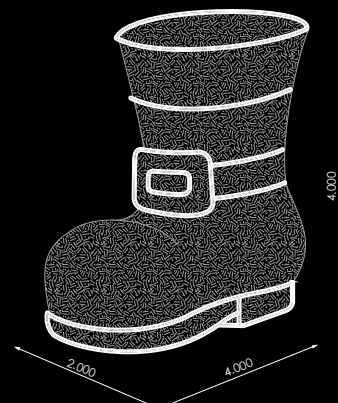



MADE IN SPAIN  
Desing by PRILUX

# Oso Selfie

**N**  
NEW

**3D**  
Motivo  
Motifs  
Motifs  
Motivos

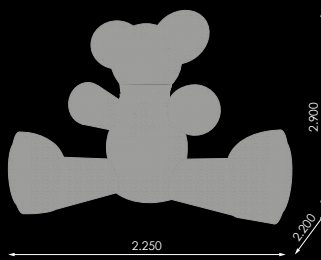

		<b>1</b>	<b>2</b>
600347	flexi	STRING <b>PLUS</b>	TAPIZ
W			
145W	24V	CIII	IP65 IP44 Plug
			90kg
			INC.

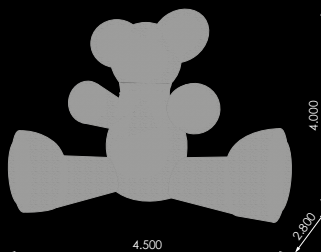

		<b>1</b>	<b>2</b>
600354	flexi	STRING <b>PLUS</b>	TAPIZ
W			
350W	24V	CIII	IP65 IP44 Plug
			180kg
			INC.

[GRÁFICOS: Unidades en mm/ GRAPHICS: Units in mm/ GRAPHIQUES: Unités en mm/ GRÁFICOS: Unidades em mm]



Motivo  
Motifs  
Motifs  
Motivos

3D

N

NEW



600378	<b>flexiLED</b>	CHAPA ALUMINIO			
<b>W</b>					
60W	24V	CIII	IP65 IP44 Plug	40kg	INC.

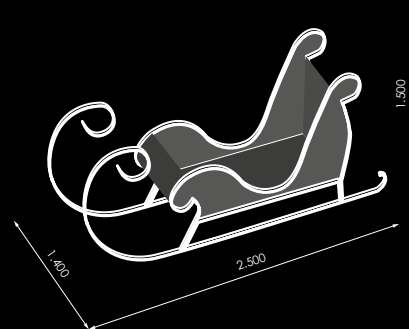

600385	<b>flexiLED</b>	CHAPA ALUMINIO			
<b>W</b>					
81W	24V	CIII	IP65 IP44 Plug	60kg	INC.

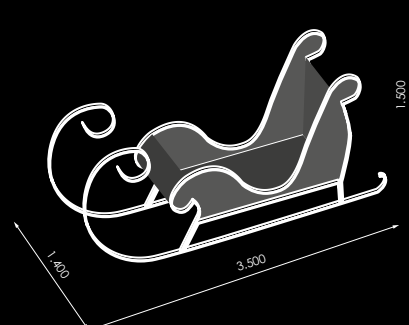





MADE IN SPAIN  
Desing by PRILUX

# Caja Regalo Sorpresa

## Selfie



**N**  
NEW

**3D**  
Motivo  
Motifs  
Motifs  
Motivos

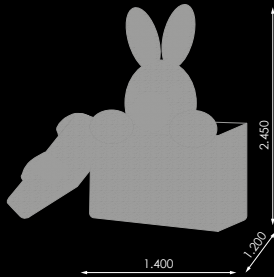

	<b>1</b>	<b>2</b>			
600330	STRING <b>PLUS</b> <b>LED</b> <b>LED</b>	TAPIZ			
<b>W</b>					
128W	24V	CIII	IP65 IP44 Plug	50kg	INC.



MADE IN SPAIN  
Desing by PRILUX

# Photocall Hexagonal



**N**  
NEW

**3D**  
Motivo  
Motifs  
Motifs  
Motivos

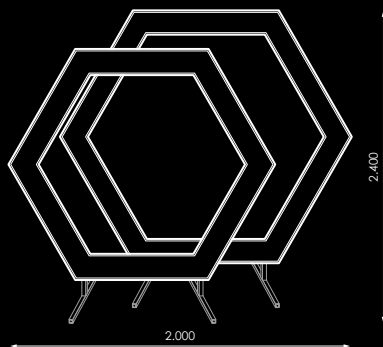

600361	<b>flexi</b> <b>LED</b>	STRING <b>PLUS</b> <b>LED</b>			
<b>W</b>					
42W	24V	CIII	IP65 IP44 Plug	25kg	INC.

[GRÁFICOS: Unidades en mm/ GRAPHICS: Units in mm/ GRAPHIQUES: Unités en mm/ GRÁFICOS: Unidades em mm]

Aviso/Warning/Avertissement/Aviso

Ñ/ Se suministra sin flores.

E/ Supplied without flowers.

F/ Livré sans fleurs.

P/ Fornecido sem flores.

# Photocall Elf



MADE IN SPAIN  
Desing by PRILUX

Motivo  
Motifs  
Motifs  
Motivos

3D



Gavá  
Barcelona

512206	flexiLED	TAPIZ			
361W	24V (XMAS) 230V (Resto)	CII	IP65 IP44 Plug	125kg	INC.







MADE IN SPAIN  
Desing by PRILUX

# Photocall Reindeer

3D Motivo  
Motifs  
Motifs  
Motivos



Fuenlabrada  
Madrid



[GRÁFICOS: Unidades en mm/ GRAPHICS: Units in mm/ GRAPHIQUES: Unités en mm/ GRÁFICOS: Unidades em mm]



512213	flexi	TAPIZ			
W					
342W	24V (XMAS) 230V (Resto)	CII	IP65 IP44 Plug	125kg	INC.

# Corazón Portal



MADE IN SPAIN  
Desing by PRILUX

Motivo  
Motifs  
Motifs  
Motivos

3D

N

NEW



600262	flexiLED	STRING PLUS LED	TAPIZ		
W					
144W	24V	CIII	IP65 IP44 Plug	70kg	INC.

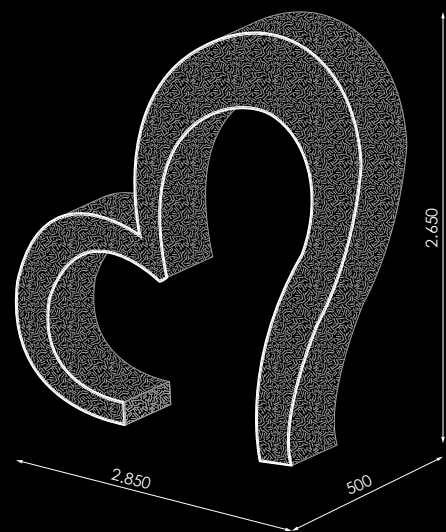

Bajo pedido / On request / Sur commande / A pedido

Ñ/ Posibilidad utilizar PVC NET en lugar de tapiz.

E/ Possibility to use PVC NET instead of tapestry.

F/ Possibilité d'utiliser du PVC NET à la place de la tapisserie.

P/ Possibilidade de usar PVC NET em vez de tapeçaria.





MADE IN SPAIN  
Desing by PRILUX

# Campana Transitable

**N**  
NEW

**3D**  
Motivo  
Motifs  
Motifs  
Motivos



[GRÁFICOS: Unidades en mm/ GRAPHICS: Units in mm/ GRAPHIQUES: Unités en mm/ GRÁFICOS: Unidades em mm]

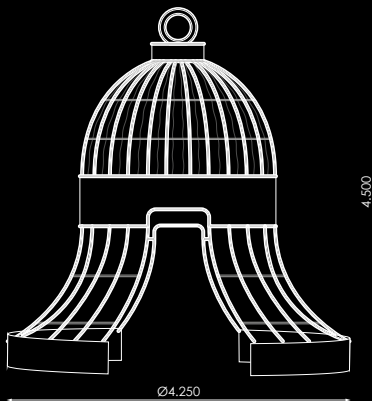

600248	flexiLED	STRING PLUS LED				
515W	24V	CIII	IP65 IP44 Plug	200kg	INC.	

Bajo pedido / On request / Sur commande / A pedido

Ñ/ Posibilidad de personalización de vinilo bajo proyecto.

E/ Possibility of customization of vinyl under project.

F/ Possibilité de personnalisation du vinyle sous projet.

P/ Possibilidade de customização de vinil sob projeto.

# Photocall Portal



MADE IN SPAIN  
Desing by PRILUX

Motivo  
Motifs  
Motifs  
Motivos

3D



Guadalupe  
Cáceres



CC Lagoh  
Sevilla

		1	2
511315	flexiLED	TAPIZ	STRING LED
511322	flexiLED	TAPIZ	STRING LED
W	⚡	⬠	⬠
726W	24V	CIII	IP65 IP44 Plug
		220kg	(2x) 205x55x55cm (2x) 180x105x55cm (2x) 175x155x10cm
			INC.

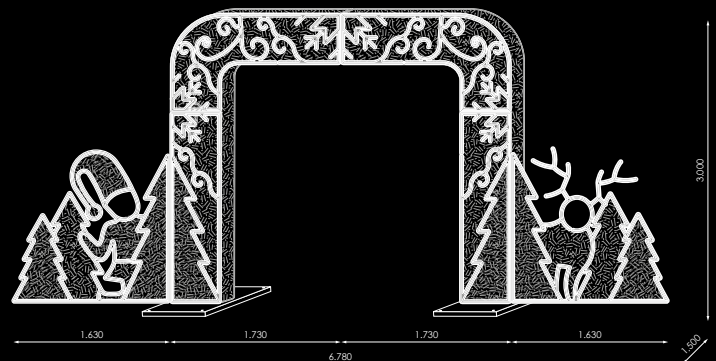





MADE IN SPAIN  
Desing by PRILUX

# Star Portal

**N**  
NEW

**3D**  
Motivo  
Motifs  
Motifs  
Motivos



[GRÁFICOS: Unidades en mm/ GRAPHICS: Units in mm/ GRAPHICS: Units in mm/ GRÁFICOS: Unidades en mm]

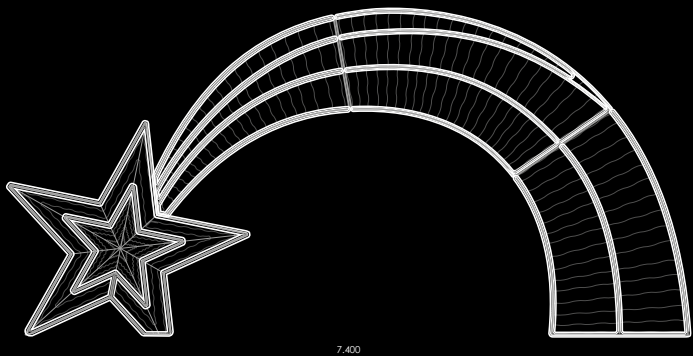

		<b>1</b>	<b>2</b>		
600255	<b>flexi</b>	STRING <b>PLUS</b>	PVC NET		
<b>W</b>					
760W	24V	CIII	IP65 IP44 Plug	260kg	INC.



# Bear Portal



MADE IN SPAIN  
Desing by PRILUX

Motivo  
Motifs  
Motifs  
Motivos

3D

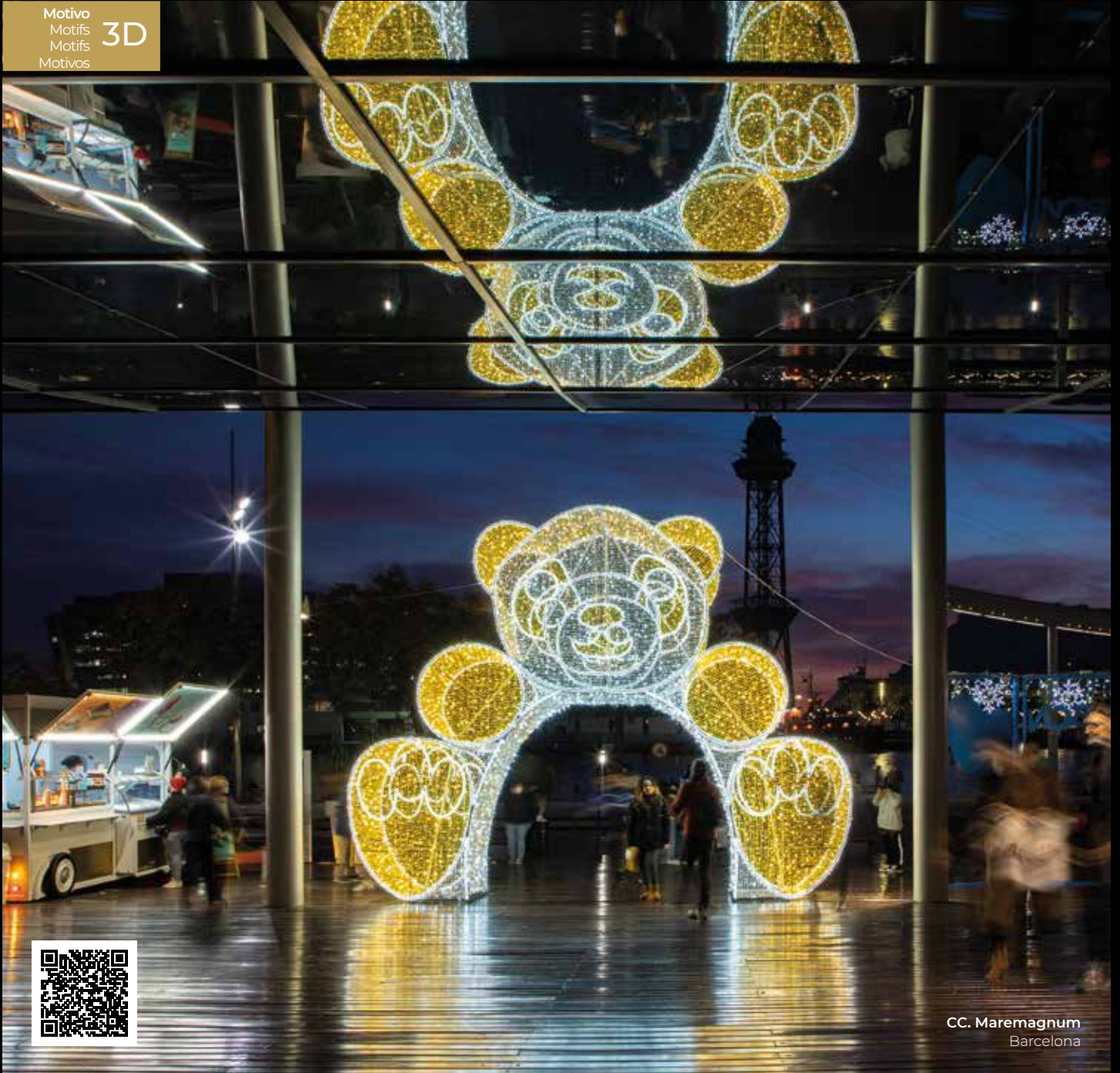

CC. Maremagnum  
Barcelona

567558	flexiLED	STRING PLUS LED LED	PVC NET		
804,6W	24V	CIII	IP65 IP44 Plug	300kg	INC.

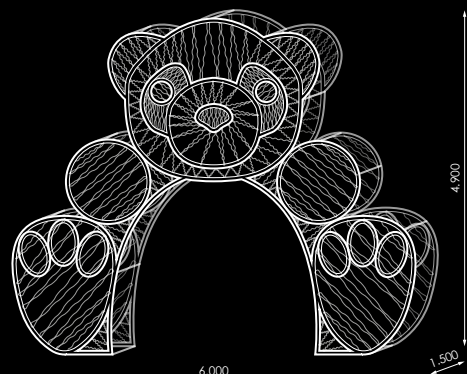





MADE IN SPAIN  
Desing by PRILUX

# Penguin Portal

3D Motivo  
Motifs  
Motifs  
Motivos

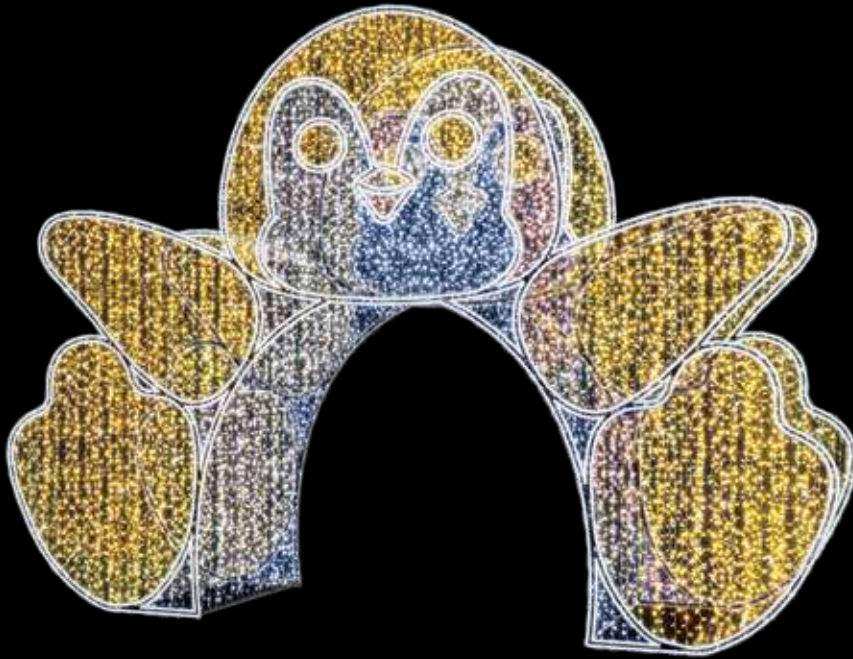

[GRÁFICOS: Unidades en mm/ GRAPHICS: Units in mm/ GRAPHIQUES: Unités en mm/ GRÁFICOS: Unidades em mm]

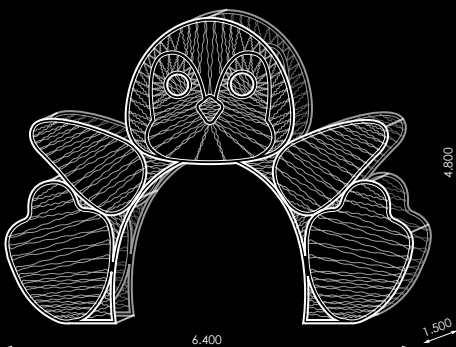

567565	flexiLED	STRING PLUS LED LED	PVC NET		
W					
720W	24V	CIII	IP65 IP44 Plug	245kg	INC.

# Xmas Portal



MADE IN SPAIN  
Desing by PRILUX

Motivo  
Motifs  
Motifs  
Motivos

3D



Camargo  
Santander

567572	flexi LED	STRING PLUS LED LED LED	PVC NET		
550W	24V	CIII	IP65 IP44 Plug	210kg	INC.

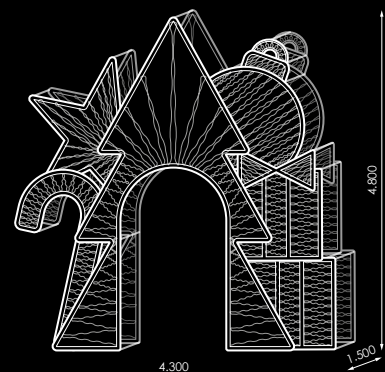





MADE IN SPAIN  
Desing by PRILUX

# Tunel Transitable

3D Motivo  
Motifs  
Motifs  
Motivos



Ciudad de Funchal, Isla de Madeira (Portugal)  
by TC Luz & Eventos  
Producto Prilux



[GRÁFICOS: Unidades en mm/ GRAPHICS: Units in mm/ GRÁFICOS: Units in mm/ GRAPHICS: Units in mm/ GRÁFICOS: Unidades em mm]

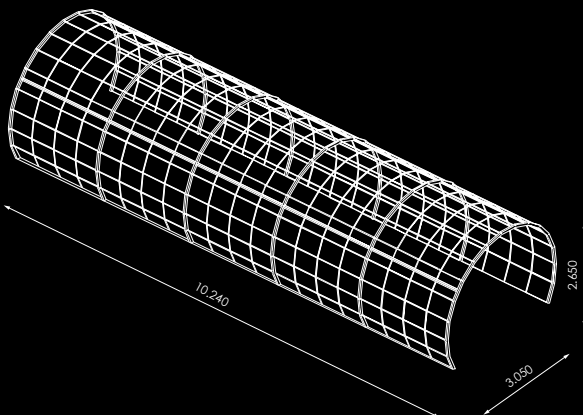

511247	3,14x2,80x10,24m	STRING PIXELMAX RGB	12V	4.980W	350kg

# Globo Ayika



MADE IN SPAIN  
Desing by PRILUX

Motivo  
Motifs  
Motifs  
Motivos

3D

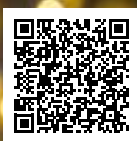

Santa Brígida  
Gran Canarias

		1	2
567589	flexi LED	STRING PLUS LED	TAPIZ
567596	flexi LED	STRING PLUS LED	TAPIZ
W	⚡	□	⊙
140W	230V	CII	IP65 IP44 Plug
			kg
			INC.

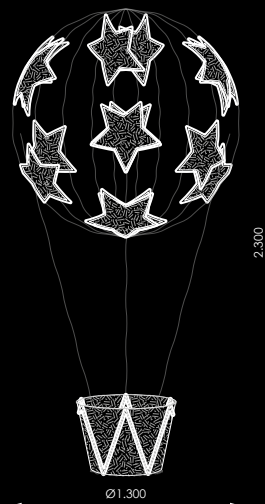





MADE IN SPAIN  
Desing by PRILUX

# Globo Bahín Maxibrillo

3D  
Motivo  
Motifs  
Motifs  
Motivos



CC. Ribera del Xuquer  
Valencia



[GRÁFICOS: Unidades en mm/ GRAPHICS: Units in mm/GRÁFICOS: Unidades en mm/GRAPHICS: Units in mm/GRÁFICOS: Unidades en mm]

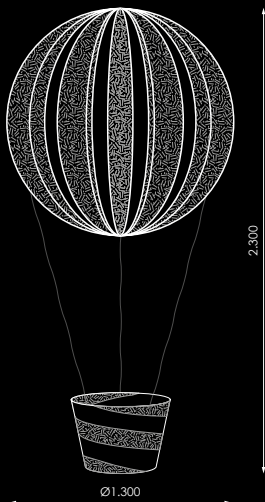

		<b>1</b>	<b>2</b>
454643	<b>flexiLED</b>	STRING PLUS	TAPIZ
459075	<b>flexiLED</b>	STRING PLUS	TAPIZ
<b>W</b>			
416W	230V	CII	IP65 IP44 Plug
			30kg
			INC.

Motivo  
Motifs  
Motifs  
Motivos

3D



Guareña  
Cáceres



Ø90cm

	1	2
446310	flexi LED STRING PLUS LED	TAPIZ
446327	flexi LED STRING PLUS LED	TAPIZ
W	⚡	□
73W	230V	CII
	⦿	⦿
	IP65	IP44 Plug
	⚖	⚖
	6kg	95x95x65cm
	📦	📦
	INC.	INC.



Ø130cm

	1	2
446358	flexi LED STRING PLUS LED	TAPIZ
446365	flexi LED STRING PLUS LED	TAPIZ
W	⚡	□
105W	230V	CII
	⦿	⦿
	IP65	IP44 Plug
	⚖	⚖
	12,5kg	135x135x85cm
	📦	📦
	INC.	INC.

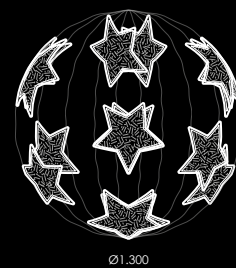



MADE IN SPAIN  
Desing by PRILUX

# Bahín Maxibrillo

3D Motivo  
Motifs  
Motifs  
Motivos



[GRÁFICOS: Unidades en mm/ GRAPHICS: Units in mm/ GRAPHIQUES: Unités en mm/ GRÁFICOS: Unidades em mm]

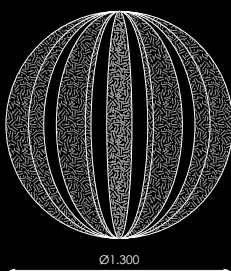
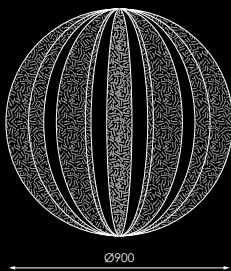

Ø90cm						
Icon	Code	Brand	Material	Power	Voltage	Dim. (cm)
	444958	flexiLED	TAPIZ	277W	230V	95x95x65
□	444965	flexiLED	TAPIZ			
■	444972	flexiLED	TAPIZ			
⚡		□	⊙	⚖	📦	🍷
277W	230V	CII	IP65 IP44 Plug	6,5kg	95x95x65cm	INC.

Ø130cm						
Icon	Code	Brand	Material	Power	Voltage	Dim. (cm)
	445009	flexiLED	TAPIZ	378W	230V	135x135x85
□	445016	flexiLED	TAPIZ			
■	445023	flexiLED	TAPIZ			
⚡		□	⊙	⚖	📦	🍷
378W	230V	CII	IP65 IP44 Plug	11kg	135x135x85cm	INC.



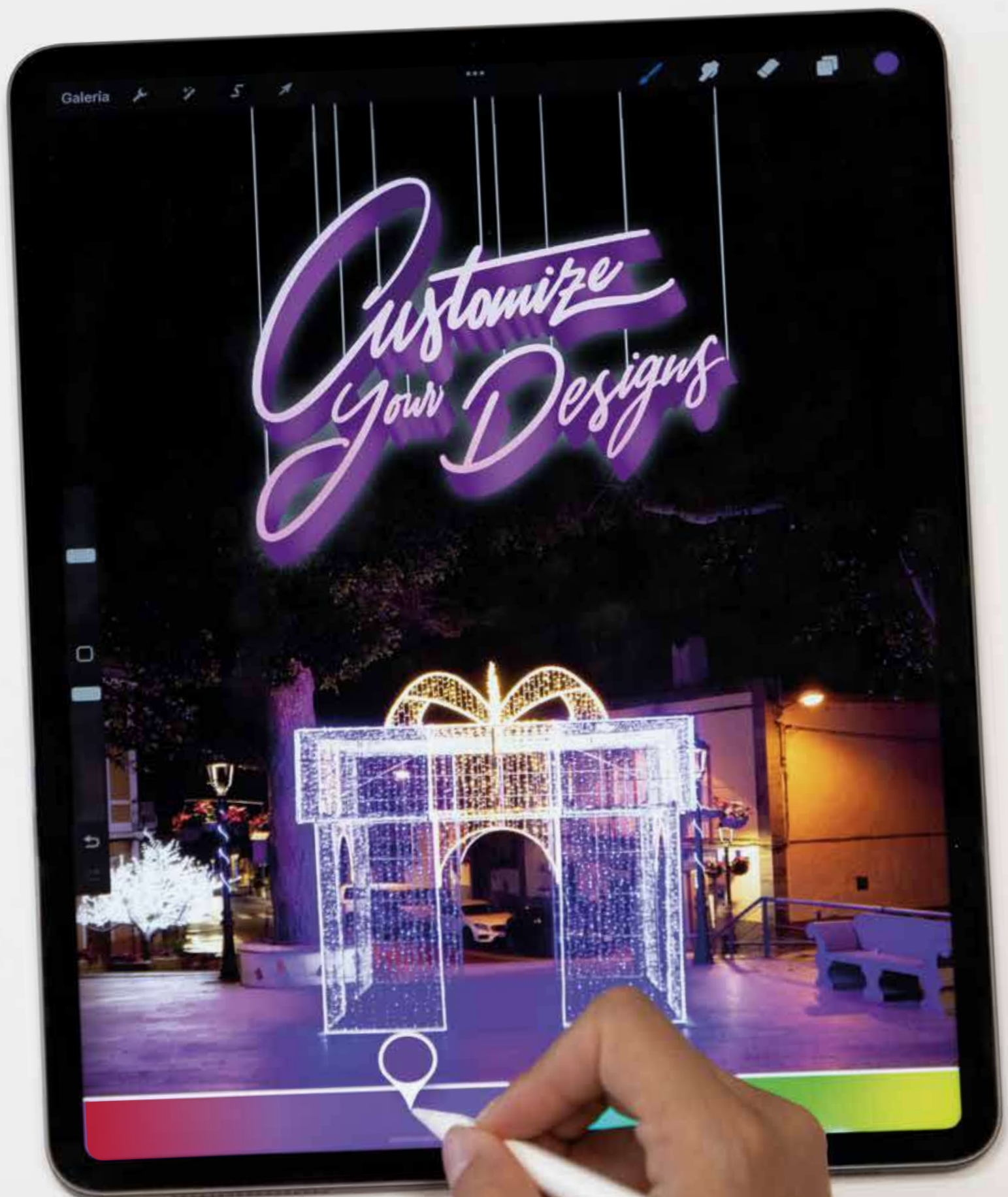

Galeria

Customize  
Your Designs

+ info



# Sphere 3D

**N**  
NEW

**3D** Motivo  
Motifs  
Motifs  
Motivos

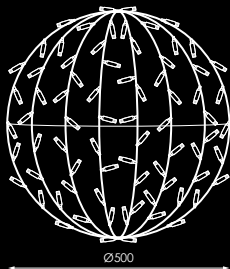

597548	STRING	PLUS	LED			
597555	STRING	PLUS	LED			
597562	STRING	PLUS	LED			
597579	STRING	PLUS	LED			
597609	STRING	PLUS	LED			
597616	STRING	PLUS	LED			
W	⚡	□	⦿	⚖	📦	🔌
13,8W	230V	CII	IP65 IP44 Plug	1,65kg	52x52x12cm	INC.

Información / Information / Information / Informações

[GRÁFICOS: Unidades en mm/ GRAPHS: Units in mm/ GRAPHIQUES: Unités en mm/ GRÁFICOS: Unidades em mm]

Ñ/ Motivo 3D PLEGABLE

E/ 3D FOLDING motive

F/Motif 3D PLIABLE

P/ Motivo 3D DOBRÁVEL

# Sphere 3D



MADE IN SPAIN  
Desing by PRILUX

Motivo  
Motifs  
Motifs  
Motivos

3D



Galdar  
Las Palmas, Gran Canarias

Ø90cm			
		W	
445467	STRING <b>PLUS</b> <b>LED</b>	26W	
445450	STRING <b>PLUS</b> <b>LED</b>	26W	
445528	STRING <b>PLUS</b> <b>LED</b>	26W	
445511	STRING <b>PLUS</b> <b>LED</b>	26W	
488860	STRING <b>PLUS</b> <b>LED</b>	27,6W	
510592	STRING <b>PLUS</b> <b>LED</b>	27,6W	
230V	CII	IP65 IP44 Plug	5kg
93x93x40cm			INC.

Ø130cm			
		W	
445481	STRING <b>PLUS</b> <b>LED</b>	27W	
445474	STRING <b>PLUS</b> <b>LED</b>	27W	
445542	STRING <b>PLUS</b> <b>LED</b>	27W	
445535	STRING <b>PLUS</b> <b>LED</b>	27W	
488877	STRING <b>PLUS</b> <b>LED</b>	37W	
510608	STRING <b>PLUS</b> <b>LED</b>	37W	
230V	CII	IP65 IP44 Plug	6kg
133x133x50cm			INC.

Ø160cm			
		W	
445504	STRING <b>PLUS</b> <b>LED</b>	34W	
445498	STRING <b>PLUS</b> <b>LED</b>	34W	
445566	STRING <b>PLUS</b> <b>LED</b>	34W	
445559	STRING <b>PLUS</b> <b>LED</b>	34W	
488884	STRING <b>PLUS</b> <b>LED</b>	46W	
510615	STRING <b>PLUS</b> <b>LED</b>	46W	
230V	CII	IP65 IP44 Plug	7,5kg
163x163x60cm			INC.

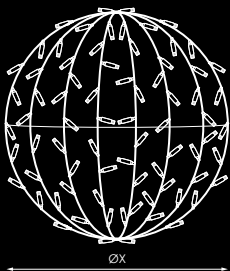

Información / Information / Information / Informações

Ñ/ Motivo 3D PLEGABLE

E/ 3D FOLDING motive

F/Motif 3D PLIABLE

P/ Motivo 3D DOBRÁVEL





MADE IN SPAIN  
Desing by PRILUX

# Bola Mimbre



3D Motivo  
Motifs  
Motifs  
Motivos



Almonte  
Huelva

Ø30cm	
566872	
233521	
144636	
144643	
602228	
602235	
602242	
<b>W</b>	
9W 230V CII IP44 INC.	

Ø60cm	
469746	
233514	
144704	
144711	
575201	
602259	
602266	
<b>W</b>	
28W 230V CII IP44 INC.	

Ø80cm	
469739	
160445	
144766	
144773	
144797	
602273	
582438	
<b>W</b>	
45W 230V CII IP44 INC.	

Ø100cm	
520959	
364911	
364935	
365079	
364898	
210812	
210829	
<b>W</b>	
67,2W 230V CII IP44 INC.	

Ø120cm	
566889	
364928	
364942	
210836	
364904	
210843	
210867	
<b>W</b>	
96W 230V CII IP44 INC.	

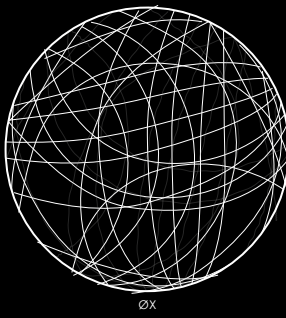

[GRÁFICOS: Unidades en mm/ GRAPHICS: Units in mm/GRÁFICOS: Unités en mm/GRÁFICOS: Unidades en mm]

# 3D Lamps



MADE IN SPAIN  
Desing by PRILUX

Motivo  
Motifs  
Motifs  
Motivos

**3D**

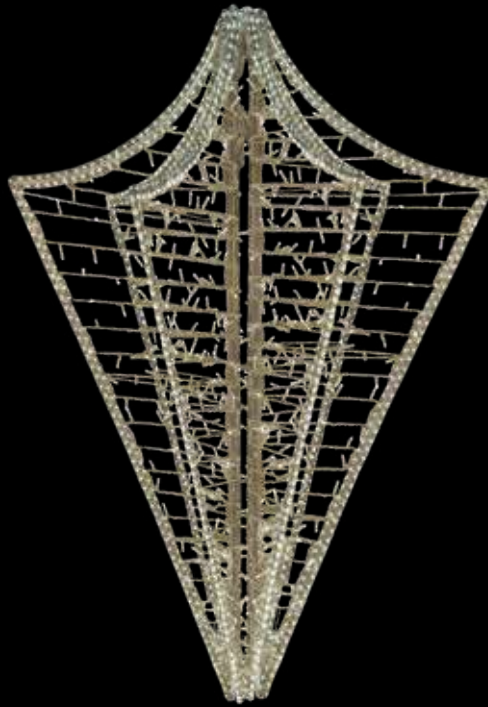

A

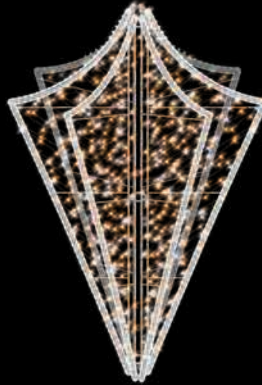

B

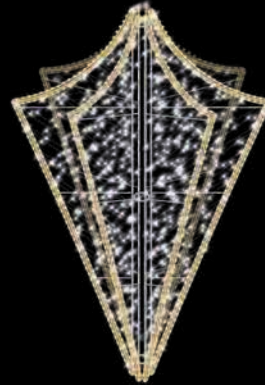

C



Barcode	Code	LED Type	String Type	Power (W)
510516	A	flexi LED	STRING PLUS LED	166W
510523	B	flexi LED	STRING PLUS LED	140W
510530	C	flexi LED	STRING PLUS LED	140W

⚡	□	⊙	⚖	📦	⚙️
230V	CII	IP65 IP44 Plug	15,5kg	(3x) 210x74x10cm	INC.



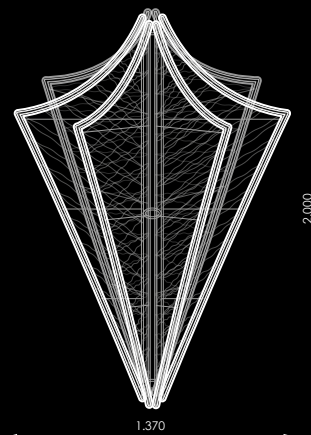

MADE IN SPAIN  
Desing by PRILUX

# 3D Stars

3D Motivo  
Motifs  
Motifs  
Motivos



A



B



C

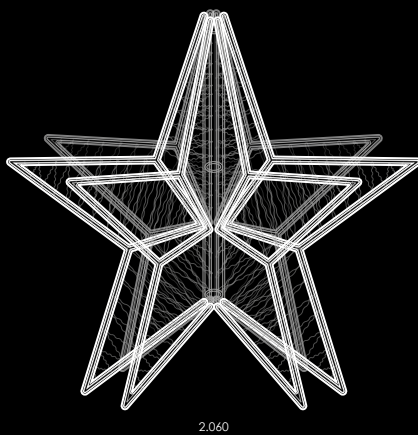

		1	2	W
510486	A	flexiLED STRING PLUS LED	PVC NET	276W
510493	B	flexiLED STRING PLUS LED	PVC NET	186W
510509	C	flexiLED STRING PLUS LED	PVC NET	186W
⚡	□	⦿	⚖	📦
230V	CII	IP65 IP44 Plug	22kg	(3x) 200x110x10cm INC.

[GRÁFICOS: Unidades en mm/ GRAPHICS: Units in mm/ GRAPHIQUES: Unités en mm/ GRÁFICOS: Unidades em mm]



# Renos

## 3D Tapiz



MADE IN SPAIN  
Desing by PRILUX

Motivo  
Motifs  
Motifs  
Motivos

3D



563086	flexiLED	STRING PLUS LED	TAPIZ		
W					
95W	24V	CIII	IP65 IP44 Plug	35kg	INC.

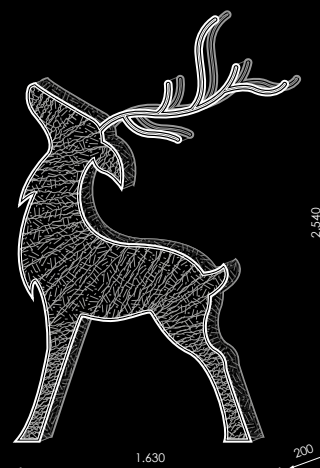

563093	flexiLED	STRING PLUS LED	TAPIZ		
W					
90W	24V	CIII	IP65 IP44 Plug	30kg	INC.

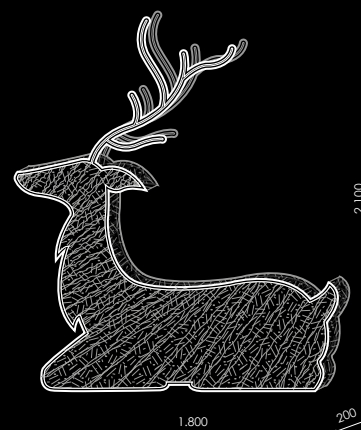

563109	flexiLED	STRING PLUS LED	TAPIZ		
W					
95W	24V	CIII	IP65 IP44 Plug	34kg	INC.

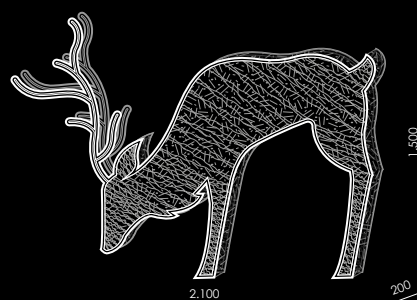



Gavá  
Barcelona



Gavá  
Barcelona



# Reno 3D

Motivo  
Motifs  
Motifs  
Motivos

3D

90cm



120cm



180cm



563253		0,9m

3,6W	3IV	CIII	IP44	120	INC.



563246		1,2m

3,6W	3IV	CIII	IP44	240	INC.



563284		1,8m

3,6W	3IV	CIII	IP44	360	INC.



## Información / Information / Information / Informações

Ñ/ Estructura blanca metálica.

E/ White metal structure.

F/ Structure métallique blanche.

P/ Estructura de metal branco.





MADE IN SPAIN  
Desing by PRILUX

# Vitela Line

**3D** Motivo  
Motifs  
Motifs  
Motivos



[GRÁFICOS: Unidades en mm/ GRAPHICS: Units in mm/ GRÁFICOS: Unidades en mm/ GRAPHICS: Units in mm/ GRÁFICOS: Unidades en mm]



3x2m			
392631	Cluster Fall Lite		
392624	Cluster Fall Lite		
<b>W</b>			
17,5W	230V	CII	IP20
18kg	202x50x10cm	INC.	

5x2m			
392655	Cluster Fall Lite		
<b>W</b>			
30W	230V	CII	IP20
20,5kg	202x50x10cm	INC.	

10x2m			
392679	Cluster Fall Lite		
392662	Cluster Fall Lite		
<b>W</b>			
60W	230V	CII	IP20
26,5kg	202x50x10cm	INC.	

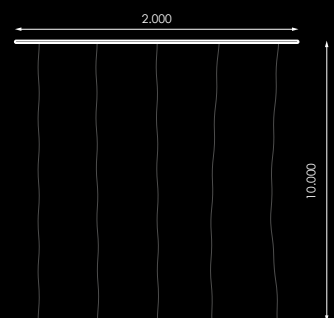
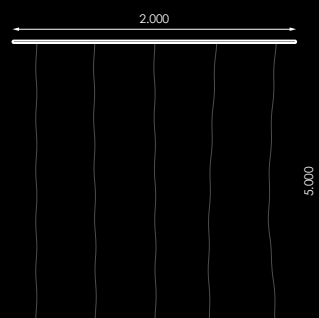
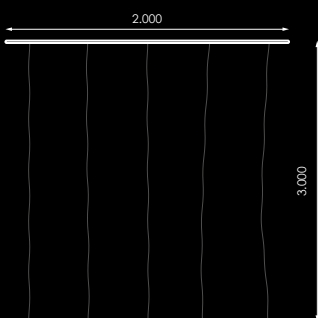

# Nacimiento 3D



MADE IN SPAIN  
Desing by PRILUX

Motivo  
Motifs  
Motifs  
Motivos

3D



Vega de San Mateo  
Gran Canarias



511339	flexi LED LED	STRING PLUS LED LED	TAPIZ		
W					
259W	24V	CIII	IP65 IP44 Plug	62kg	INC.





MADE IN SPAIN  
Desing by PRILUX

# Nacimiento 3D

## Completo

3D Motivo  
Motifs  
Motifs  
Motivos



Arucas  
Gran Canarias



[GRÁFICOS: Unidades en mm/ GRAPHICS: Units in mm/ GRAPHIQUES: Units in mm/ GRÁFICOS: Unidades em mm]

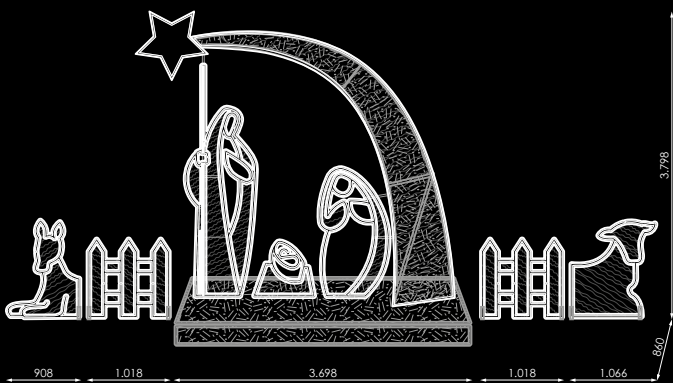

511353	flexi LED LED	STRING PLUS LED LED	TAPIZ
W			
402W	24V	CIII	IP65 IP44 Plug
	79kg		INC.



# Nacimiento

## Pequeño



MADE IN SPAIN  
Desing by PRILUX

Motivo  
Motifs  
Motifs  
Motivos

3D



Canarias



551946	
227W	230V
CII	IP44
INC.	

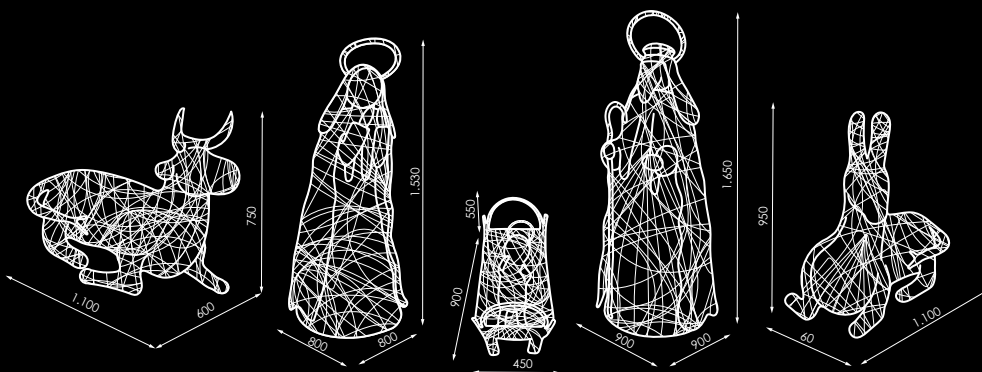





MADE IN SPAIN  
Desing by PRILUX

# Nacimiento

## Grande

3D Motivo  
Motifs  
Motifs  
Motivos



Pozuelo de Alarcón  
Madrid



[GRÁFICOS: Unidades en mm/ GRAPHICS: Units in mm/ GRAPHIQUES: Unités en mm/ GRÁFICOS: Unidades em mm]

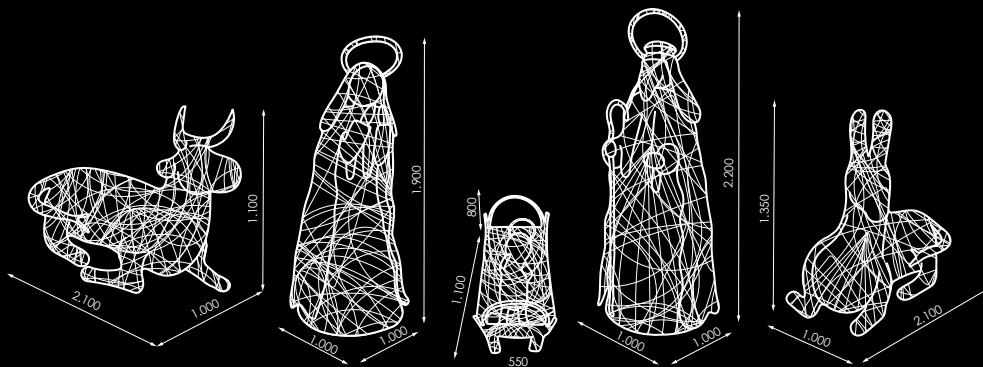

365239	LED			
W				
350W	230V	CII	IP44	INC.





# Sistemas dinámicos

Dynamic systems

Systèmes dynamiques

Sistemas dinâmicos

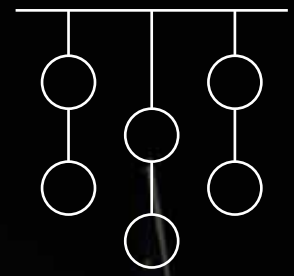

# flexiLIGHT LED

Maxibrillo RGB



⚡ 230V ac

Hz 50-60Hz

□ CII

⊙ 1 Canal/ 2 Vías

⊙ IP44 PLUG

IP65

∠ 120°

🌡️ -20°C~+60 °C

⊠ NO INC.

🌀 Rollo 50m

Ñ/ Exterior/Textura Lisa/Tapa final **INCLUIDA**  
 E/ Outside/Smooth Texture/End cover **INCLUDED**  
 F/ À L'extérieur/Texture Lisse/Couvercle **INCLUS**  
 P/ Exterior/Textura Lisa/Tampa final **INCLUIDA**

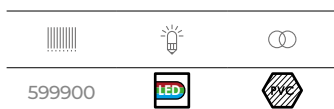

599900

✂️	1m
∅	19x7mm
☀️	60
W%	10W
W	500W
🔗	Max. 50m
⊙	Rollo 50m

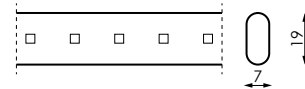

Accesorios (NO Incluidos) / Accessoires (NOT Included) / Accessories (NON Inclus)/ Acessórios (NÃO Incluso)

+ INFO PAG. 260

599917  
Controlador con mando a distancia

600972  
Empalme

600965  
Tapa final

# flexiLIGHT LED

## Double Neon RGB

N

NEW



	230V ac
<b>Hz</b>	50-60Hz
	CII
	1 Canal/ 2 Vías
	IP44 PLUG
	IP65
	360°
	-20°C~+60 °C
	NO INC.
	Rollo 50m

Ñ/ Exterior/Textura Lisa/Tapa final **INCLUIDA**  
 E/ Outside/Smooth Texture/End cover **INCLUDED**  
 F/ À L'exterieur/Texture Lisse/ Couvercle **INCLUS**  
 P/ Exterior/Textura Lisa/Tampa final **INCLUIDA**

[GRÁFICOS: Unidades en mm/ GRAPHICS: Units in mm/ GRÁFICOS: Unidades em mm/ GRÁFICOS: Units in mm/ GRAPHICS: Units in mm/ GRÁFICOS: Unidades em mm]

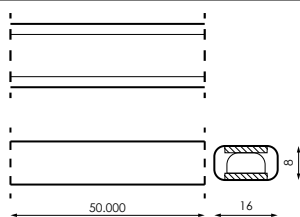

ESQUEMA DE DOBLADO

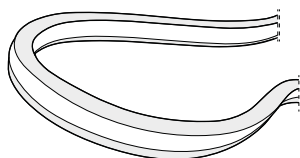

	1m
	8x16mm
	120
	10W
<b>W</b>	500W
	Max. 50m
	Rollo 50m

599887	LED	PVC

Accesorios (NO Incluidos) / Accessoires (NOT Included) / Accessories (NON Inclus) / Acessórios (NÃO Incluso)

+ INFO PAG. 260

599894	Controlador con mando a distancia
--------	-----------------------------------

600958	Empalme
--------	---------

600941	Tapa final
--------	------------



# flexiLIGHT LED

RGBWW



**N**  
NEW

⚡ 230V dc

Hz 50-60Hz

□ CII

⊙ IP65

△ 360°

🌡️ -20°C~+60 °C

⊗ NO INC.

⊗ NO INC.

🌀 Rollo 40m

Ñ/ Exterior/Textura lisa/Tapa final **INCLUIDA**.  
E/ Outside/Smooth texture/ End cover **INCLUDED**.  
F/ À L'extérieur/Texture lisse/ Couvreclé **INCLUS**.  
P/ Exterior/Textura lisa/Tampa final **INCLUIDA**.

561273		

	1m
∅	13mm
	36
W/%	4,6W
W	184W
	Max. 100m
	Rollo 40m

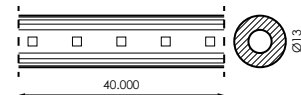

ESQUEMA INSTALACIÓN/  
INSTALLATION SCHEME/  
SCHEMA D'INSTALLATION/  
ESQUEMA DE INSTALAÇÃO



## Aviso/Warning/Avertissement/Aviso

Ñ/ Los efectos de cambio de color solo funcionan con el controlador que es de **USO OBLIGATORIO**.

E/ The color change effects only work with the controller that is **OBLIGATORY**.

F/ Les effets de changement de couleur fonctionnent uniquement avec le contrôleur qui est **OBLIGATOIRE**.

P/ Os efeitos de mudança de cor funcionam apenas com o controlador que é **USO OBRIGATÓRIO**.

## Accesorios (NO Incluidos) / Accessoires (NOT Included) / Accessories (NON Inclus)/ Acessórios (NÃO Incluso)

+ INFO PAG. 260

Ñ/ Adaptador **NO INCLUIDO**.

E/ Adapter **NOT INCLUDED**.

F/ Adaptateur **NON INCLUS**.

P/ Adaptador **NÃO INCLUÍDO**.









514514	Controlador RGBWW con mando a distancia sin adaptador
514491	Controlador RGBWW pasarela DMX sin adaptador

566520	Controlador RGBWW sincronización GPS sin adaptador
192453	Adaptador blanco SMART-FLEXILIGHT

514507	Controlador RGBWW sincronización Power line sin adaptador
192477	Adaptador negro SMART-FLEXILIGHT

# flexiLIGHT LED

## RGB

	230V dc
<b>Hz</b>	50-60Hz
	CII
	IP65
	360°
	-20°C~+60 °C
	NO INC.
	NO INC.
	Rollo 40m

Ñ/ Exterior/Textura lisa/Tapa final **INCLUIDA**.  
 E/ Outside/Smooth texture/ End cover **INCLUDED**.  
 F/ À L'extérieur/Texture lisse/ Couvercle **INCLUS**.  
 P/ Exterior/Textura lisa/Tampa final **INCLUIDA**.





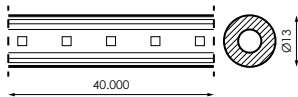

CC As Cancelas  
Santiago de Compostela



ESQUEMA INSTALACIÓN/  
INSTALLATION SCHEME/  
SCHEMA D'INSTALLATION/  
ESQUEMA DE INSTALAÇÃO



	1m
	13mm
	36
	4,6W
<b>W</b>	184W
	Max. 100m
	Rollo 40m

		
546676		

### Aviso/Warning/Avertissement/Aviso

Ñ/ Los efectos de cambio de color solo funcionan con el controlador que es de **USO OBLIGATORIO**.

E/ The color change effects only work with the controller that is **OBLIGATORY**.

F/ Les effets de changement de couleur fonctionnent uniquement avec le contrôleur qui est **OBLIGATOIRE**.

P/ Os efeitos de mudança de cor funcionam apenas com o controlador que é **USO OBRIGATÓRIO**.

### Accesorios (NO Incluidos) / Accessoires (NOT Included) / Accessories (NON Inclus) / Acessórios (NÃO Incluso)

+ INFO PAG. 260

Ñ/ Adaptador **NO INCLUIDO**.

E/ Adapter **NOT INCLUDED**.

F/ Adaptateur **NON INCLUS**.

P/ Adaptador **NÃO INCLuíDO**.

571845
Controlador RGB con mando a distancia sin adaptador
486279
Controlador RGB pasarela DMX sin adaptador

N 600705
Controlador RGB con mando a distancia sin adaptador

454261
Controlador RGB sincronización GPS sin adaptador

486262
Controlador RGB sincronización Power line sin adaptador

# flexiLIGHT LED

CW-WWW



⚡ 230V dc

Hz 50-60Hz

□ CII

⊙ IP65

△ 360°

🌡️ -20°C~+60 °C

⊗ NO INC.

⊗ NO INC.

🌀 Rollo 40m

Ñ/ Exterior/Textura lisa/Tapa final **INCLUIDA**.  
 E/ Outside/Smooth texture/ End cover **INCLUDED**.  
 F/ A L'exterieur/Texture lisse/ Couvercle **INCLUS**.  
 P/ Exterior/Textura lisa/Tampa final **INCLUIDA**.



486347



✂️	1m
∅	13mm
💡	36
W/⚡	4,6W
W	184W
🔗	Max. 55m
🌀	Rollo 40m

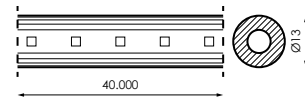

ESQUEMA INSTALACIÓN/  
 INSTALLATION SCHEME/  
 SCHEMA D'INSTALLATION/  
 ESQUEMA DE INSTALAÇÃO



## Aviso/Warning/Avertissement/Aviso

Ñ/ Los efectos de cambio de color solo funcionan con el controlador que es de **USO OBLIGATORIO**.

E/ The color change effects only work with the controller that is **OBLIGATORY**.

F/ Les effets de changement de couleur fonctionnent uniquement avec le contrôleur qui est **OBLIGATOIRE**.

P/ Os efeitos de mudança de cor funcionam apenas com o controlador que é **USO OBRIGATÓRIO**.

## Accesorios (NO Incluidos) / Accessoires (NOT Included) / Accessories (NON Inclus)/ Acessórios (NÃO Incluso)

+ INFO PAG. 260

Ñ/ Adaptador **NO INCLUIDO**.

E/ Adapter **NOT INCLUDED**.

F/ Adaptateur **NON INCLUS**.

P/ Adaptador **NÃO INCLUIDO**.

486309	Controlador CW-WWW con mando a distancia sin adaptador
486330	Controlador CW-WWW pasarela DMX sin adaptador

486316	Controlador CW-WWW sincronización GPS sin adaptador
192453	Adaptador blanco SMART-FLEXILIGHT

486323	Controlador CW-WWW sincronización Power line sin adaptador
192477	Adaptador negro SMART-FLEXILIGHT



# STRING **PLUS** 100

## RGBWW

	230V dc
<b>Hz</b>	50-60Hz
	CII
	1 CANAL
	IP65
	-20°C~+60 °C
	NO INC.
	10ud



SMART LINK

La Palma del Condado  
Huelva

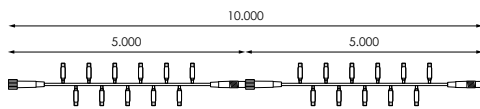

ESQUEMA INSTALACIÓN/  
INSTALLATION SCHEME/  
SCHEMA D'INSTALLATION/  
ESQUEMA DE INSTALAÇÃO



Producto/Product  
Produit/Produto

	10m (5m x 2seg)
	5m
	100
	50
	5,3W
<b>W</b>	10,6W
	100m

514477		
514484		

### Aviso/Warning/Avertissement/Aviso

**Ñ**/ Los efectos de cambio de color solo funcionan con el controlador que es de **USO OBLIGATORIO** y con 10m de String Plus RGBWW.

**E**/ The color change effects only work with the controller that is **OBLIGATORY** and with 10m of String Plus RGBWW.

**F**/ Les effets de changement de couleur fonctionnent uniquement avec le contrôleur qui est **OBLIGATOIRE** et avec 10m de String Plus RGBWW.

**P**/ Os efeitos de mudança de cor funcionam apenas com o controlador que é **USO OBLIGATORIO** e com 10m de String Plus RGBWW.

### Accesorios (NO Incluidos) / Accessoires (NOT Included) / Accessories (NON Inclus)/ Acessórios (NÃO Incluso)

+ INFO PAG. 260

**Ñ**/ Compatible con todos los accesorios **SMART LINK**

**E**/ Compatible with all **SMART LINK** accessories

514514

Controlador RGBWW con mando a distancia.

514507

Controlador RGBWW sincronización Power line.

566520

Controlador RGBWW sincronización GPS. Máx.100m/línea

514491

Controlador RGBWW pasarela DMX.

**F**/ Compatible avec tous les accessoires **SMART LINK**

**P**/ Compatível com todos os acessórios **SMART LINK**

# STRING **PLUS** 100

## RGB



SMART LINK

**N**  
NEW



Plaza Navarra  
Huesca

⚡ 230V dc

Hz 50-60Hz

□ CII

☺ 1 CANAL

°° IP65

🌡 -20°C~+60 °C

⊠ NO INC.

📦 10ud

571807		
571814		
571821		

↔	10m (5m x 2seg)
⏏	5m
💡	100
💡	50
⏏	4,6W
W	9,2W
⚙	100m

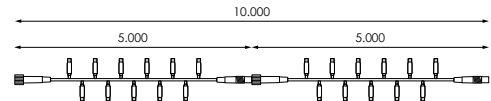

ESQUEMA INSTALACIÓN/  
INSTALLATION SCHEME/  
SCHEMA D'INSTALLATION/  
ESQUEMA DE INSTALAÇÃO



+

Producto/Product  
Prodot/Produto

### Aviso/Warning/Avertissement/Aviso

Ñ/ Los efectos de cambio de color solo funcionan con el controlador que es de **USO OBLIGATORIO** y con 10m de String Plus RGB.

E/ The color change effects only work with the controller that is **OBLIGATORY** and with 10m of String Plus RGB.

F/ Les effets de changement de couleur fonctionnent uniquement avec le contrôleur qui est **OBLIGATOIRE** et avec 10m de String Plus RGB.

P/ Os efeitos de mudança de cor funcionam apenas com o controlador que é **USO OBRIGATÓRIO** e com 10m de String Plus RGB.

### Accesorios (NO Incluidos) / Accessoires (NOT Included) / Accessories (NON Inclus)/ Acessórios (NÃO Incluso)

+ INFO PAG. 260

Ñ/ Compatible con todos los accesorios **SMART LINK**

E/ Compatible with all **SMART LINK** accessories

F/ Compatible avec tous les accessoires **SMART LINK**

P/ Compatível com todos os acessórios **SMART LINK**

571845

Controlador RGB con mando a distancia.

486279

Controlador RGB pasarela DMX.

**N** 600705

Controlador RGB con mando a distancia.

454261

Controlador RGB sincronización GPS.

486262

Controlador RGB sincronización Power line.

# STRING **PLUS** 100

CW-WW

	230V dc
<b>Hz</b>	50-60Hz
	CII
	1 CANAL
	IP65
	-20°C~+60 °C
	NO INC.
	10ud

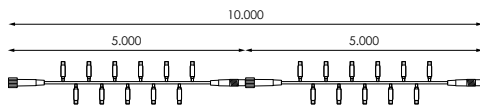
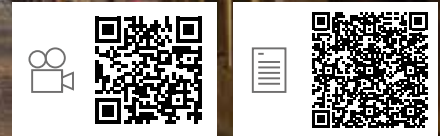

ESQUEMA INSTALACIÓN/  
INSTALLATION SCHEME/  
SCHEMA D'INSTALLATION/  
ESQUEMA DE INSTALAÇÃO



Producto/Product  
Produit/Produto

	10m (5m x 2seg)
	5m
	100
	50
	5,3W
<b>W</b>	10,6W
	100m

486286		
486293		

## Aviso/Warning/Avertissement/Aviso

**Ñ/** Los efectos de cambio de color solo funcionan con el controlador que es de **USO OBLIGATORIO** y con 10m de String Plus CW/WW.

**E/** The color change effects only work with the controller that is **OBLIGATORY** and with 10m of String Plus CW/WW.

**F/** Les effets de changement de couleur fonctionnent uniquement avec le contrôleur qui est **OBLIGATOIRE** et avec 10m de String Plus CW/WW.

**P/** Os efeitos de mudança de cor funcionam apenas com o controlador que é **USO OBLIGATORIO** e com 10m de String Plus CW/WW.

## Accesorios (NO Incluidos) / Accessoires (NOT Included) / Accessories (NON Inclus)/ Acessórios (NÃO Incluso)

+ INFO PAG. 260

**Ñ/** Compatible con todos los accesorios **SMART LINK**

**E/** Compatible with all **SMART LINK** accessories

486309

Controlador CW-WW con mando a distancia.

486323

Controlador CW-WW sincronización Power line.

486316

Controlador CW-WW sincronización GPS.

486330

Controlador CW-WW pasarela DMX.



# SCREENLIGHT 400

RGB

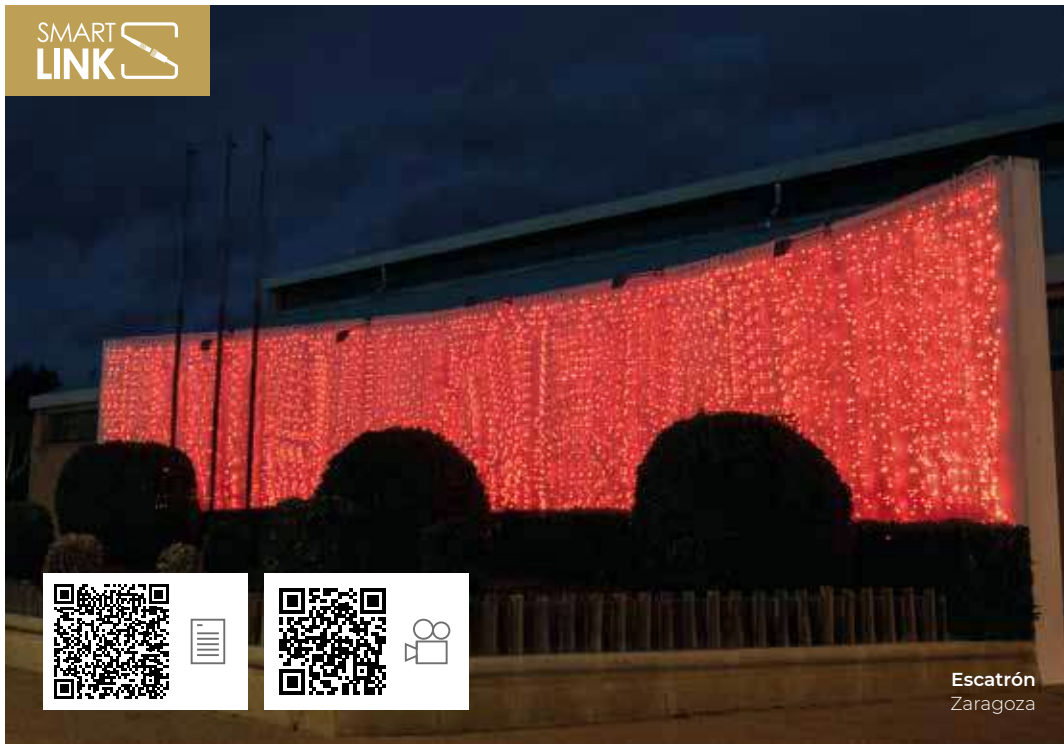

SMART LINK 

 230V dc

Hz 50-60Hz

 CII

 1 CANAL

 IP65

 -20°C~+60 °C



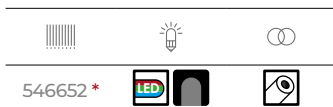

 NO INC.

 5ud



546652 \*



	2x2m
	20 (2 tiras = 1 serie)
	400
	20
W	46W
	5sets

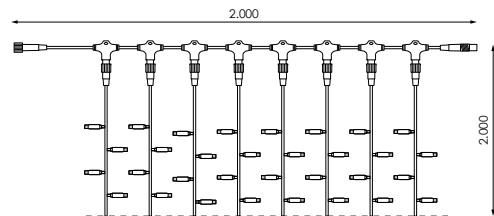

ESQUEMA INSTALACIÓN/  
INSTALLATION SCHEME/  
SCHEMA D'INSTALLATION/  
ESQUEMA DE INSTALAÇÃO



+

Producto/Product  
Produit/Produto

## Aviso/Warning/Avertissement/Aviso

Ñ/ Los efectos de cambio de color solo funcionan con el controlador que es de **USO OBLIGATORIO**.

E/ The color change effects only work with the controller that is **OBLIGATORY**.

F/ Les effets de changement de couleur fonctionnent uniquement avec le contrôleur qui est **OBLIGATOIRE**.

P/ Os efeitos de mudança de cor funcionam apenas com o controlador que é **USO OBRIGATÓRIO**.

## Accesorios (NO Incluidos) / Accessoires (NOT Included) / Accessories (NON Inclus)/ Acessórios (NÃO Incluso)

+ INFO PAG. 260

Ñ/ Compatible con todos los accesorios **SMART LINK**

E/ Compatible with all **SMART LINK** accessories

F/ Compatible avec tous les accessoires **SMART LINK**

P/ Compatível com todos os acessórios **SMART LINK**

571845

Controlador RGB con mando a distancia.

486279

Controlador RGB pasarela DMX.

N 600705

Controlador RGB con mando a distancia.

454261

Controlador RGB sincronización GPS.







486262

Controlador RGB sincronización Power line.

\*Hasta fin de existencias/\* Until end of stock/\* Jusqu'à épuisement des stocks/\* Enquanto os estoques durarem

# SCREENLIGHT 400

RGBWW

	230V dc
<b>Hz</b>	50-60Hz
	CII
	1 CANAL
	IP65
	-20°C~+60 °C
	NO INC.
	5ud





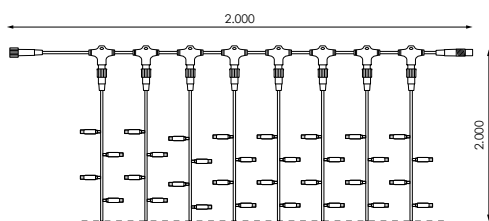







Arucas  
Canarias



ESQUEMA INSTALACIÓN/  
INSTALLATION SCHEME/  
SCHEMA D'INSTALLATION/  
ESQUEMA DE INSTALAÇÃO



+ Producto/Product  
Produit/Produto

	2x2m			
	20 (2 tiras = 1 serie)	588850		
	400			
	20			
<b>W</b>	46W			
	7sets			

## Aviso/Warning/Avertissement/Aviso

**Ñ/** Los efectos de cambio de color solo funcionan con el controlador que es de **USO OBLIGATORIO**.

**E/** The color change effects only work with the controller that is **OBLIGATORY**.

**F/** Les effets de changement de couleur fonctionnent uniquement avec le contrôleur qui est **OBLIGATOIRE**.

**P/** Os efeitos de mudança de cor funcionam apenas com o controlador que é **USO OBRIGATÓRIO**.

## Accesorios (NO Incluidos) / Accessoires (NOT Included) / Accessories (NON Inclus)/ Acessórios (NÃO Incluso)

+ INFO PAG. 260

**Ñ/** Compatible con todos los accesorios **SMART LINK**

**E/** Compatible with all **SMART LINK** accessories

514514

Controlador RGBWW con mando a distancia.

566520

Controlador RGBWW sincronización GPS.

**F/** Compatible avec tous les accessoires **SMART LINK**

**P/** Compatível com todos os acessórios **SMART LINK**

514507

Controlador RGBWW sincronización Power line.

514491

Controlador RGBWW pasarela DMX.

# ICICLE<sup>®</sup> 174

RGB



⚡ 230V dc

Hz 50-60Hz

□ CII

☺ 1 CANAL

°° IP65

🌡 -20°C~+60 °C

⊗ NO INC.

📦 10ud

571838 *		

	3x0,9m (1m x 3seg)
	Nº 3
	174
	58
	W 13,8W
	15sets

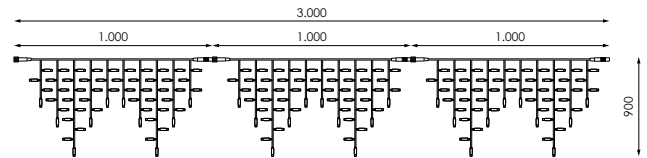

ESQUEMA INSTALACIÓN/  
INSTALLATION SCHEME/  
SCHEMA D'INSTALLATION/  
ESQUEMA DE  
INSTALAÇÃO



+

Producto/Product  
Produit/Produto

## Aviso/Warning/Avertissement/Aviso

**Ñ/** Los efectos de cambio de color solo funcionan con el controlador que es de **USO OBLIGATORIO**.

**E/** The color change effects only work with the controller that is **OBLIGATORY**.

**F/** Les effets de changement de couleur fonctionnent uniquement avec le contrôleur qui est **OBLIGATOIRE**.

**P/** Os efeitos de mudança de cor funcionam apenas com o controlador que é **USO OBRIGATÓRIO**.

## Accesorios (NO Incluidos) / Accessoires (NOT Included) / Accessories (NON Inclus)/ Acessórios (NÃO Incluso)

+ INFO PAG. 260

**Ñ/** Compatible con todos los accesorios **SMART LINK**

**E/** Compatible with all **SMART LINK** accessories

**F/** Compatible avec tous les accessoires **SMART LINK**

**P/** Compatível com todos os acessórios **SMART LINK**

571845

Controlador RGB con mando a distancia.

N 600705

Controlador RGB con mando a distancia.

454261

Controlador RGB sincronización GPS.

486262

Controlador RGB sincronización Power line.

486279

Controlador RGB pasarela DMX.

\*Hasta fin de existencias/\* Until end of stock/\* Jusqu'à épuisement des stocks/\* Enquanto os estoques durarem



# ICICLE 174

RGBWW

	230V dc
<b>Hz</b>	50-60Hz
	CII
	1 CANAL
	IP65
	-20°C~+60 °C
	NO INC.
	10ud



[GRÁFICOS: Unidades en mm/ GRÁFICOS: Units in mm/ GRAPHIQUES: Unités en mm/ GRÁFICOS: Unidades em mm]

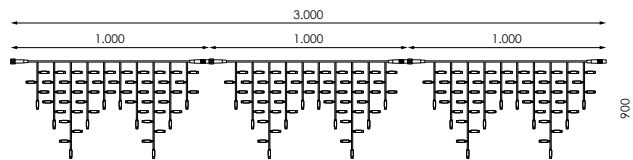

ESQUEMA INSTALACIÓN/  
INSTALLATION SCHEME/  
SCHEMA D'INSTALLATION/  
ESQUEMA DE  
INSTALAÇÃO



Producto/Product  
Produit/Produto

	3x0,9m (1m x 3seg)
	3
	174
	58
<b>W</b>	13,8W
	15sets

561464		

## Aviso/Warning/Avertissement/Aviso

**Ñ/** Los efectos de cambio de color solo funcionan con el controlador que es de **USO OBLIGATORIO**.

**E/** The color change effects only work with the controller that is **OBLIGATORY**.

**F/** Les effets de changement de couleur fonctionnent uniquement avec le contrôleur qui est **OBLIGATOIRE**.

**P/** Os efeitos de mudança de cor funcionam apenas com o controlador que é **USO OBRIGATÓRIO**.

## Accesorios (NO Incluidos) / Accessoires (NOT Included) / Accessories (NON Inclus)/ Acessórios (NÃO Incluso)

+ INFO PAG. 260

**Ñ/** Compatible con todos los accesorios **SMART LINK**

**E/** Compatible with all **SMART LINK** accessories

514514

Controlador RGBWW con mando a distancia.

514507

Controlador RGBWW sincronización Power line.

566520

Controlador RGBWW sincronización GPS. Máx. 100m/línea

514491

Controlador RGBWW pasarela DMX.

# CONTROLADORES

## RGBWW/RGB/CW-WW

### CONTROLADOR

Sincronización con mando a distancia

514514 - RGBWW  
571845/600705 - RGB  
486309 - CW/WW



Controladores RGBWW / Controlador RGB (600705):

Serie: Máx. 3.600leds

Paralelo: Máx. 4.000leds

Controladores RGB / CW-WW:

Máx. 2.000leds

### CONTROLADOR

Sincronización mediante satélite GPS.  
Cambio secuencial cada 15segundos.  
SOLO uso exterior.

566520 - RGBWW  
454261 - RGB  
486316 - CW/WW

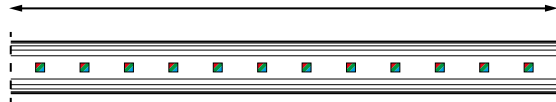
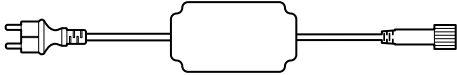

### CONTROLADOR

Sincronización con línea eléctrica.  
Cambio secuencial cada 15segundos

514507 - RGBWW  
486262 - RGB  
486323 - CW/WW

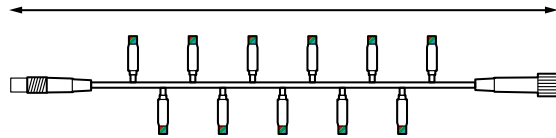
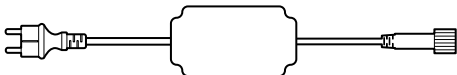
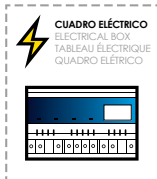

### CONTROLADOR/PASARELA DMX

Stand-Alone  
Cambio secuencial cada 15segundos  
si no recibe señal DMX

514491 - RGBWW  
486279 - RGB  
486330 - CW/WW

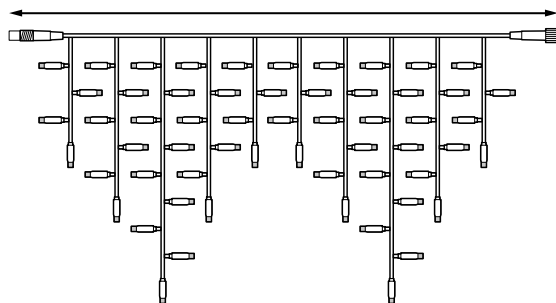
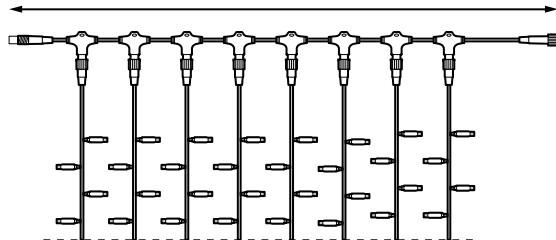
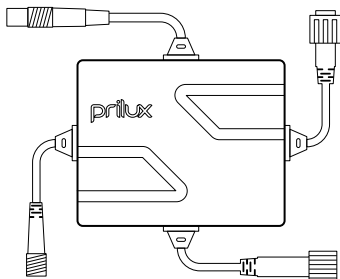

# CONTROLADORES

486279/486330/514491

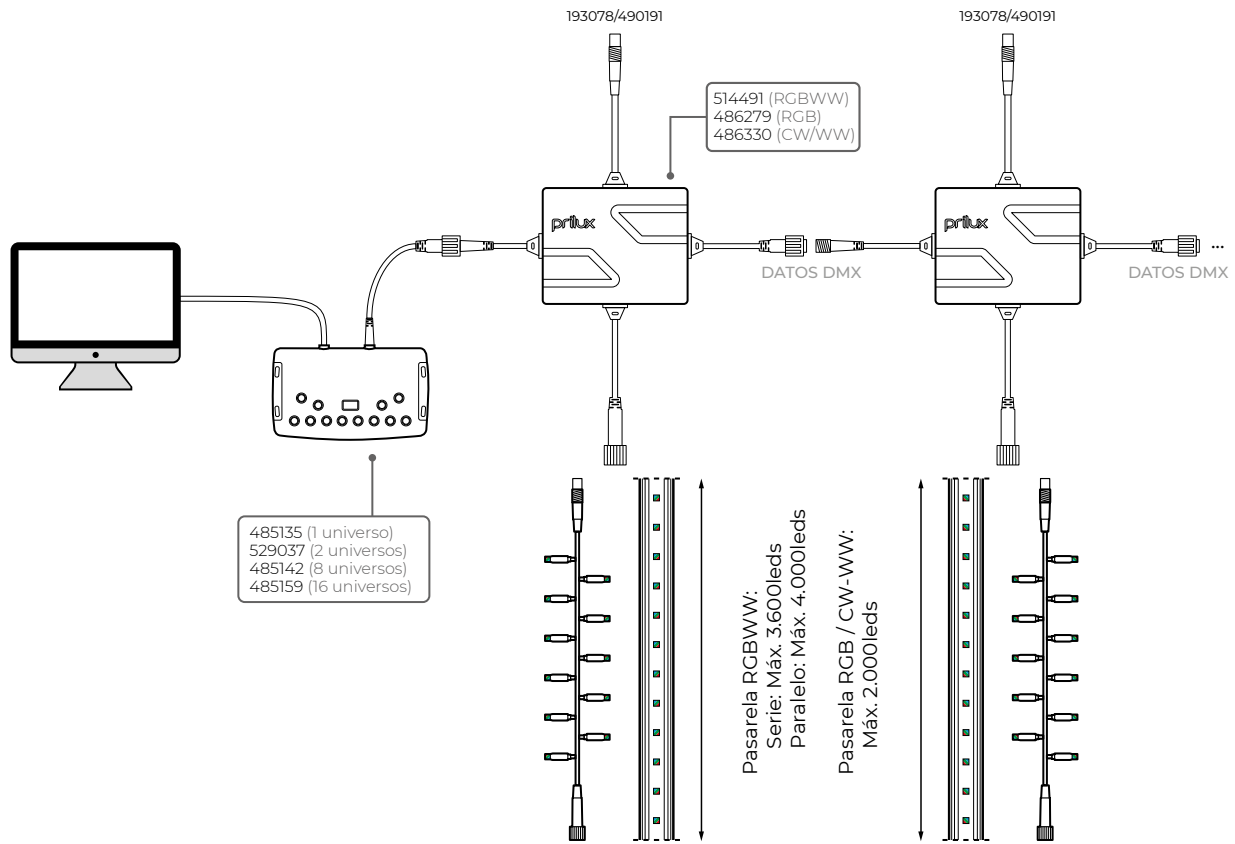

CÓDIGO CONTROLADOR DMX	UNIVERSOS	MÁX. CONTROLADORES A EMPALMAR
485135	1 universo	512 controladores
485142	8 universos	4.096 controladores
485159	16 universos	8.192 controladores

Accesorios (NO Incluidos) / Accessoires (NOT Included) / Accessories (NON Inclus) / Acessórios (NÃO Incluso)

+ INFO PAG. 260

**N/** Accesorios y cable de alimentación **NO INCLUIDOS** para utilizar entre pasarelas si hay distancia entre ellas.

**E/** Accessories and power cable **NOT INCLUDED** to be used between walkways if there is distance between them.

**F/** Accessoires et câble d'alimentation **NON INCLUS** à utiliser entre passerelles s'il existe une distance suffisante entre elles.

**P/** Acessórios e cabo de alimentação **NÃO INCLUÍDO** para ser usado entre passarelas se houver distância entre eles.

490207	Extensión DMX 1m
490214	Extensión DMX 3m
490221	Extensión DMX 5m
490245	Direccionador caja DMX
193078	Cable alimentación con shuko 1,5m
490191	Cable alimentación sin shuko 1m



# STRING **PLUS** 100 24V

Transformador



	24V dc
<b>Hz</b>	50-60Hz
	CIII
	1 CANAL
	IP44
	-20°C~+60 °C
	NO INC.
	NO INC.
	NO INC.
	10ud



486385 *		
486378		

	10m (5m x 2seg)
	5m
	100
	50
	3,6W
<b>W</b>	7,2W
	40m

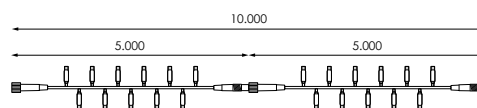

ESQUEMA INSTALACIÓN/  
INSTALLATION SCHEME/  
SCHEMA D'INSTALLATION/  
ESQUEMA DE INSTALAÇÃO



\*Hasta fin de existencias/\* Until end of stock/\* Jusqu'à épuisement des stocks/\* Enquanto os estoques durarem

# STRING **PLUS** 100 24V

## Transformador

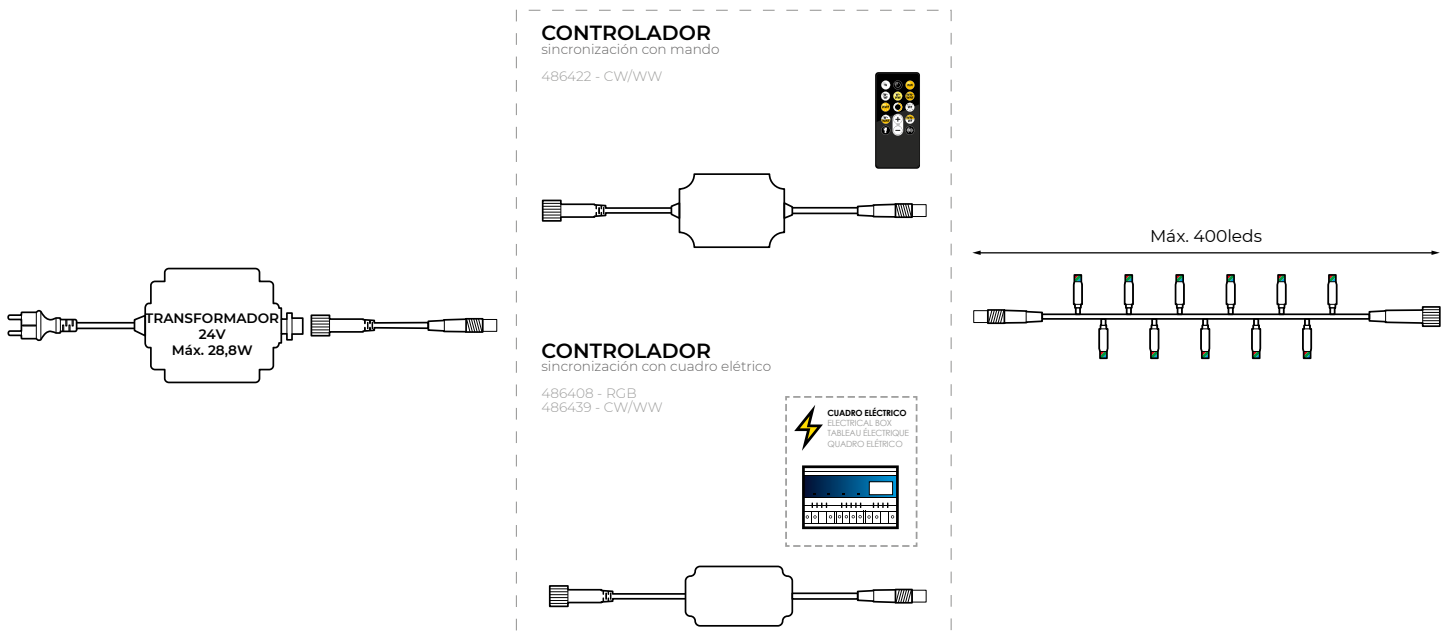

[GRÁFICOS: Unidades en mm/GRÁFICOS: Units in mm/GRAPHIQUES: Unités en mm/GRÁFICOS: Unidades em mm]

Ñ/ Los efectos de cambio de color solo funcionan con el controlador que es de **USO OBLIGATORIO**.

E/ The color change effects only work with the controller that is **OBLIGATORY**.

F/ Les effets de changement de couleur fonctionnent uniquement avec le contrôleur qui est **OBLIGATOIRE**.

P/ Os efeitos de mudança de cor funcionam apenas com o controlador que é **USO OBRIGATÓRIO**.

Aviso/Warning/Avertissement/Aviso

Accesorios (NO Incluidos) / Accessoires (NOT Included) / Accessories (NON Inclus)/ Acessórios (NÃO Incluso)

+ INFO PAG. 260

Ñ/Compatible con todos los accesorios **24V**

E/ Compatible with all **24V** accessories

F/ Compatible avec tous les accessoires **24V**

P/ Compatível com todos os acessórios **24V**

486408

Controlador RGB Sincronización Power line. Máx. 400leds. Transformador

486422

Controlador CW-WW con mando a distancia. Máx. 400leds. Transformador

486439

Controlador CW-WW sincronización Power line. Máx. 400leds. Transformador

149198

Transformador 28,8W

# STRING **PLUS** 100 24V

## Fuente alimentación



**N**  
NEW



Gavá  
Barcelona

⚡ 24V dc

Hz 50-60Hz

◇ CIII

☺ 1 CANAL

°° IP44

🌡 -20°C~+60 °C

⊗ NO INC.

⊗ NO INC.

🔌 10ud

N 588867		
486385 *		

↔	10m (5m x 2seg)
⏏	5m
💡	100
☀	50
⏏	3,6W
W	7,2W
🔌	40m

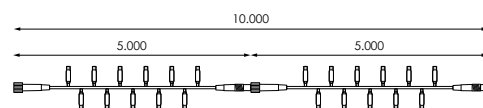

ESQUEMA INSTALCIÓN/  
INSTALLATION SCHEME/  
SCHEMA D'INSTALLATION/  
ESQUEMA DE INSTALÇÃO

⊗ PS + ⊗ C

Producto/Product  
Produit/Produto

\*Hasta fin de existencias/\* Until end of stock/\* Jusqu'à épuisement des stocks/\* Enquanto os estoques durarem



# STRING **PLUS** 100 24V

## Fuente alimentación

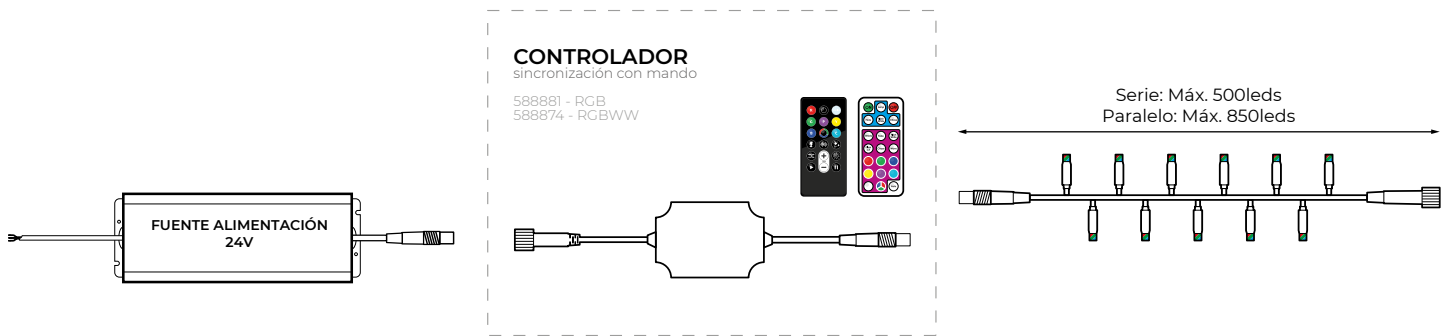

[GRÁFICOS: Unidades en mm/ GRAPHICS: Units in mm/ GRAPHIQUES: Unités en mm/ GRÁFICOS: Unidades em mm]

Ñ/ Los efectos de cambio de color solo funcionan con el controlador que es de **USO OBLIGATORIO**.

E/ The color change effects only work with the controller that is **OBLIGATORY**.

F/ Les effets de changement de couleur fonctionnent uniquement avec le contrôleur qui est **OBLIGATOIRE**.

P/ Os efeitos de mudança de cor funcionam apenas com o controlador que é **USO OBRIGATÓRIO**.

### Aviso/Warning/Avertissement/Aviso

### Accesorios (NO Incluidos) / Accessoires (NOT Included) / Accessories (NON Inclus) / Acessórios (NÃO Incluso)

+ INFO PAG. 260

Ñ/Compatible con todos los accesorios **24V**

E/ Compatible with all **24V** accessories

F/ Compatible avec tous les accessoires **24V**

P/ Compatível com todos os acessórios **24V**

588881

Controlador RGB con mando a distancia. Fuente

488464

Fuente alimentación 100W 24V

588874

Controlador RGBWW con mando a distancia. Fuente

481687

Fuente alimentación 150W 24V

488440

Fuente alimentación 30W 24V

481694

Fuente alimentación 200W 24V

488457

Fuente alimentación 60W 24V



# PIXELMAX

## Control pixel a pixel

Con la gama de productos Pixelmax es posible ofrecer efectos dinámicos realmente diferenciadores. Gracias a la tecnología Pixelmax disponemos de control individual de cada LED, tanto de color como de flujo emitido, desde un puesto de control centralizado lo que permite que convirtamos nuestra instalación en una pantalla de efectos de luz a medida. Con nuestra gama de controladores es posible cubrir las necesidades que exija cada proyecto, desde efectos dinámicos en pequeños motivos hasta convertir la fachada de un edificio en una pantalla RGB/RGBW sobre la que reproducir vídeos.

## Pixel to pixel control

With the Pixelmax product range it is possible to offer truly differentiating dynamic effects. Thanks to Pixelmax technology we have individual control of each LED, both color and flow emitted, from a centralized control post, which allows us to turn our installation into a custom light effects screen. With our range of controllers it is possible to meet the needs of each project, from dynamic effects in small motifs to converting the facade of a building into an RGB/RGBW screen on which to play videos.

## Contrôle pixel à pixel

La gamme de produits Pixelmax permet d'offrir des effets dynamiques véritablement différenciants. Grâce à la technologie Pixelmax, nous avons un contrôle individuel de chaque LED, à la fois en couleur et en flux émis, depuis un poste de contrôle centralisé, ce qui nous permet de transformer notre installation en un écran à effets de lumière personnalisé. Avec notre gamme de contrôleurs, il est possible de répondre aux besoins de chaque projet, des effets dynamiques dans les petits motifs à la conversion de la façade d'un bâtiment en un écran RGB/RGBW sur lequel lire des vidéos.

## Controle de pixel para pixel

Com a gama de produtos Pixelmax, é possível oferecer efeitos dinâmicos verdadeiramente diferenciadores. Graças à tecnologia Pixelmax, temos um controle individual de cada LED, tanto em cores quanto em fluxo, a partir de um posto de controle centralizado, o que nos permite transformar nossa instalação em uma tela de efeitos de luz personalizada. Com a nossa gama de controladores, é possível atender às necessidades de cada projeto, desde efeitos dinâmicos em pequenos motivos até a conversão da fachada de um edifício em uma tela RGB/RGBW na qual reproduzir vídeos.





CONO





# STRING PIXELMAX RGB

12V

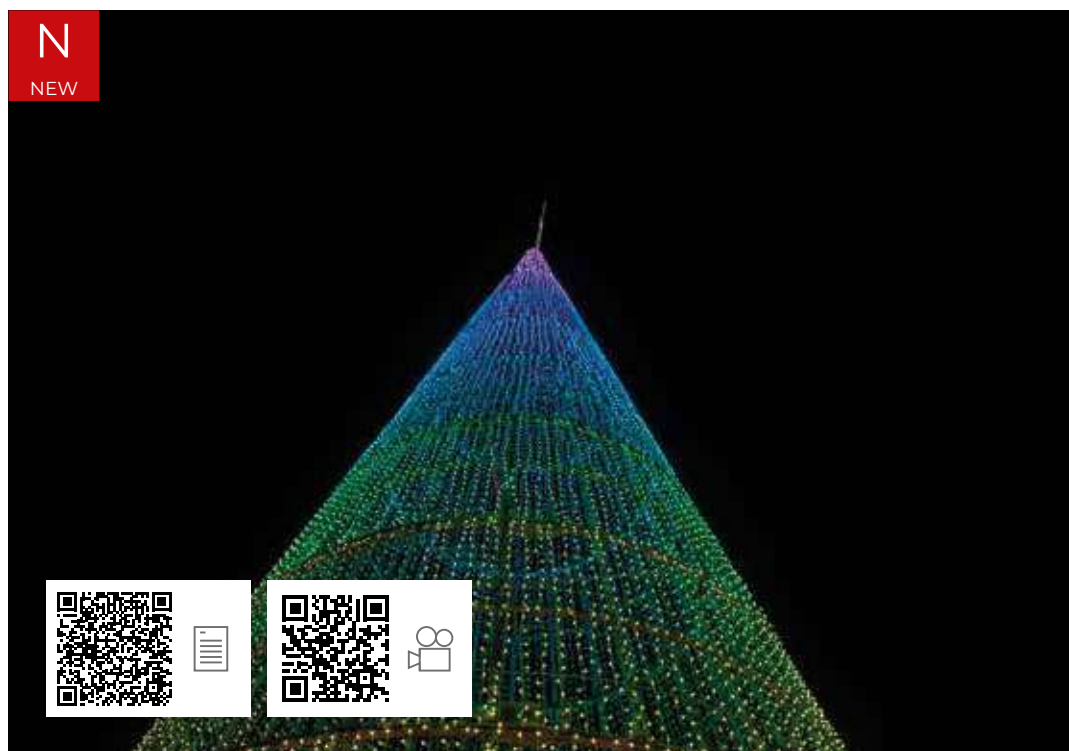

⚡ 12V dc

Hz 50-60Hz

◇ CIII

° IP68

□ NO INC.

⊞ 20ud

Ñ/ Tapa final **NO INCLUIDA.**  
 E/ End cover **NOT INCLUDED.**  
 F/ Couvercle **NON INCLUS.**  
 P/ Tampa final **NAO INCLUÍ-DA.**

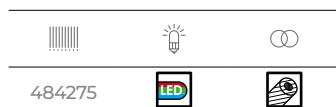

↔ 2m

💡 20

W 12W

⊞ Según Controlador

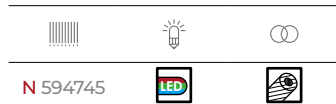
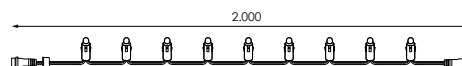

↔ 4m

💡 40

W 24W

⊞ Según Controlador

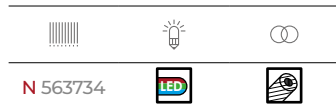
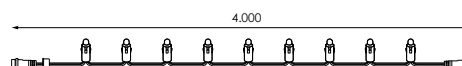

↔ 4,8m

💡 50

W 30W

⊞ Según Controlador

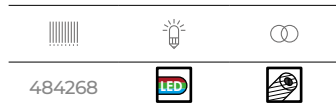
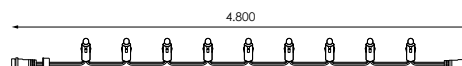

↔ 5m

💡 50

W 30W

⊞ Según Controlador

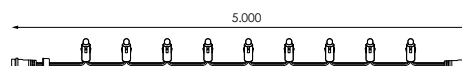

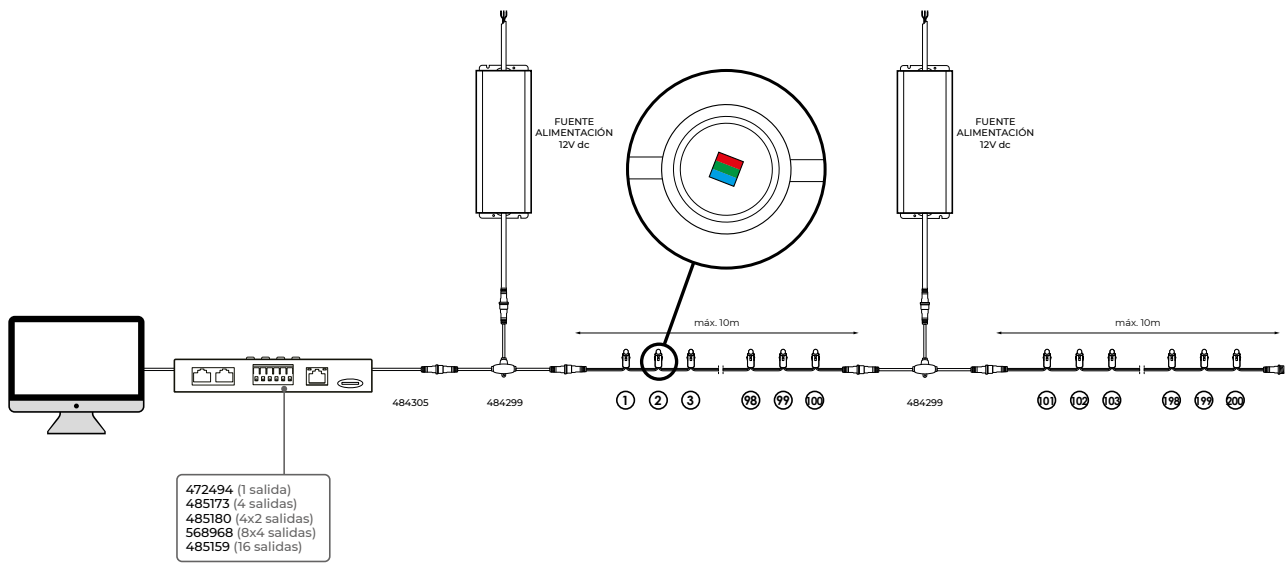

Accesorios (NO Incluidos) / Accessoires (NOT Included) / Accessories (NON Inclus)/ Acessórios (NÃO Incluso)  
+ INFO PAG. 260

<b>472494</b>	<b>485173</b>	<b>485180</b>	<b>N 568968</b>
Controlador DMX-SPI 1 salida	Controlador Master SPI 4 salidas	Controlador Master SPI 4x2 salidas	Controlador Master DMX512-SPI 8x4 salidas
<b>485159</b>	<b>484282</b>	<b>563161</b>	<b>485166</b>
Controlador Master DMX512-SPI 16 salidas	Fuente alimentación 60W 12V IP66	Fuente alimentación 250W 12V IP66	Amplificador señal DMX 3 salidas
<b>484305</b>	<b>484299</b>	<b>484343</b>	<b>484350</b>
Conector a fuente alimentación	Conector T SPI (2 entradas/1 salida)	Conector T SPI (1 entrada/2 salidas)	Conector 3 SPI (1 entrada/4 salidas)
<b>484367</b>	<b>484312</b>	<b>518154</b>	<b>484329</b>
Conector 5 SPI (1 entrada/6 salidas)	Extensión 25cm SPI	Extensión 50cm SPI	Extensión 1m SPI
<b>484336</b>	<b>518161</b>	<b>518178</b>	<b>N 594738</b>
Extensión 3m SPI	Extensión 5m SPI	Extensión 10m SPI	Tapa final
<b>N 580335</b>	<b>N 580342</b>	<b>N 580359</b>	
Power Stopper	Conector macho-macho 15cm	Conector hembra-hembra 15cm	

# STRING PIXELMAX RGB

12V

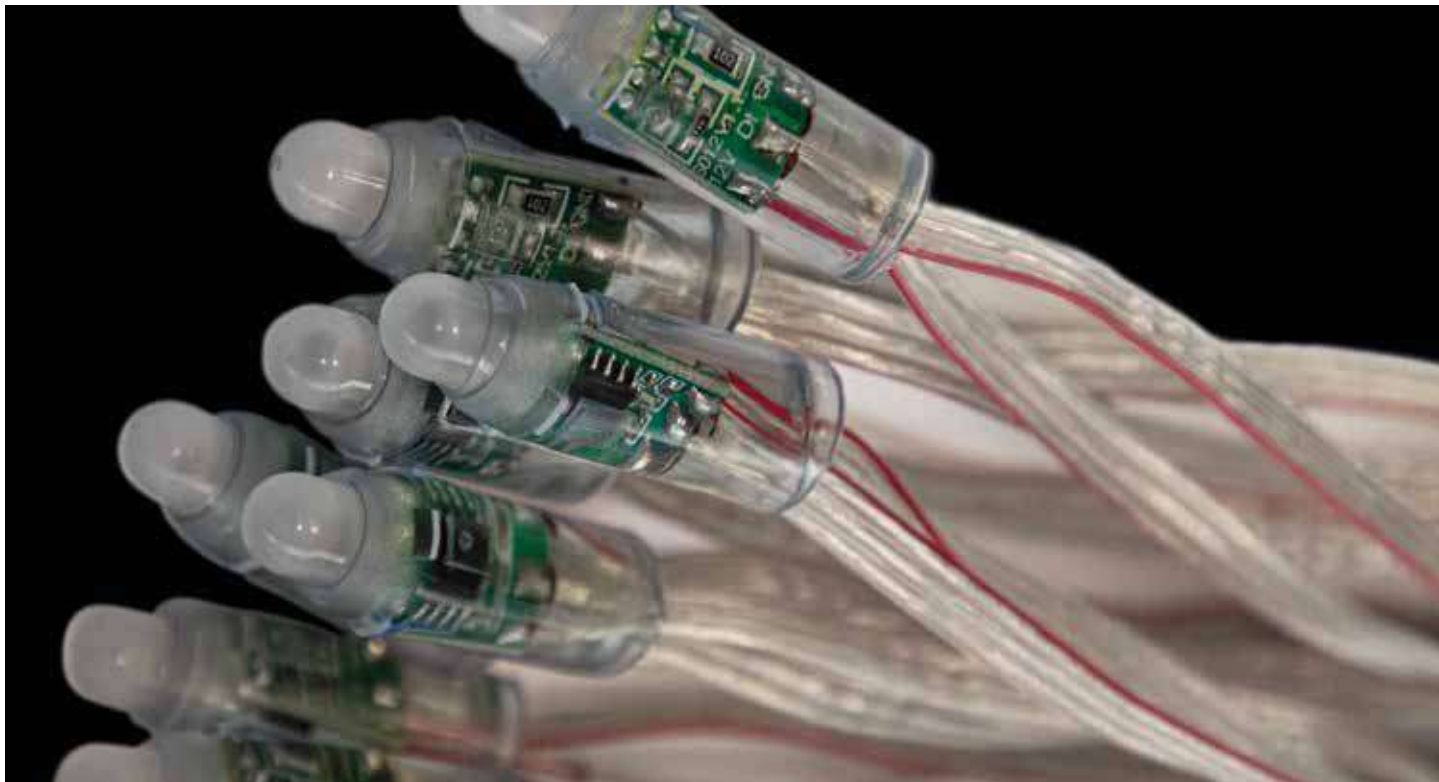

## CONEXIÓN EN PARALELO ESQUEMA INSTALACIÓN 1 SALIDA

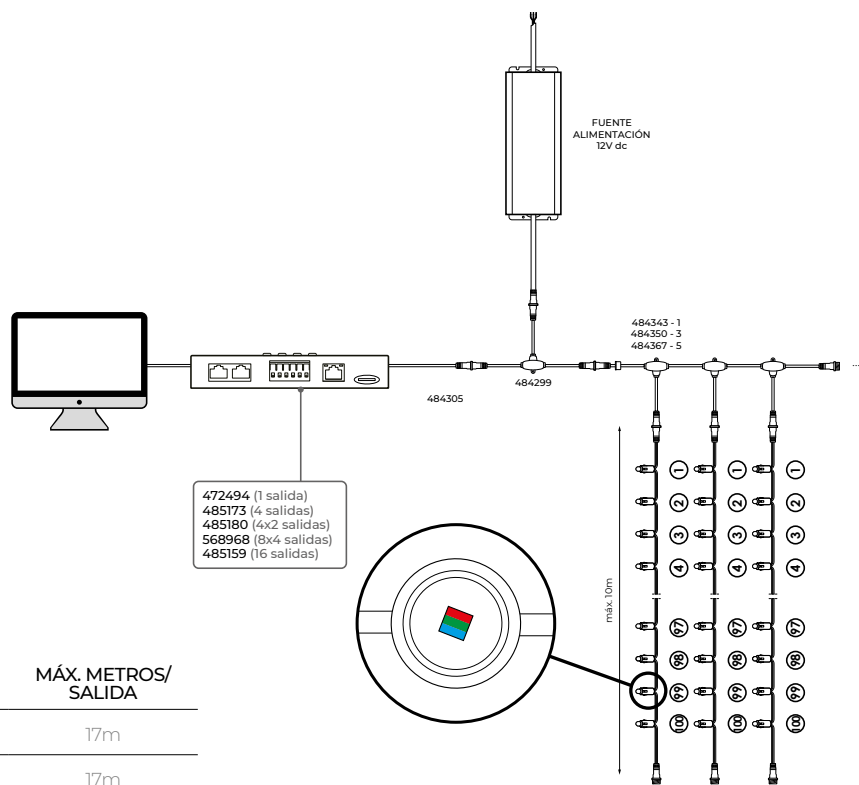

CÓDIGO CONTROLADOR	Nº SALIDAS	MÁX. PÍXELES	MÁX. METROS/SALIDA
472494	1 salida	170 píxeles	17m
485173	4 salidas	680 píxeles	17m
485180	4x2 salidas	1.360 píxeles	34m
568968	8x4 salidas	5.440 píxeles	68m
485159	16 salidas	21.760 píxeles	136m



# Diseñamos tus Espacios

*"desde el proyecto  
hasta la realización"*



## Diseñamos tus Espacios

En el Departamento de Proyectos de Grupo Prilux realizamos proyectos de decoración, sin compromiso, donde se planifican y proyectan las mejores soluciones para cubrir espacios y elementos arquitectónicos, convirtiéndolos en ambientes donde vivir una auténtica experiencia lumínica.

## We design your Spaces

In the Prilux Group Projects Department we carry out decoration projects, without obligation, where the best solutions are planned and projected to cover spaces and architectural elements, turning them into environments where you can live an authentic lighting experience.

## Nous concevons vos espaces

Dans le département Projets du Groupe Prilux, nous réalisons des projets de décoration, sans engagement, où les meilleures solutions sont planifiées et projetées pour couvrir les espaces et les éléments architecturaux, en les transformant en environnements où vous pouvez vivre une expérience d'éclairage authentique.

## Nós projetamos seus espaços

No Departamento de Projetos do Grupo Prilux realizamos projetos de decoração, sem compromisso, onde as melhores soluções são planejadas e projetadas para cobrir espaços e elementos arquitetônicos, transformando-os em ambientes onde pode viver uma autêntica experiência de iluminação.

# DOT DMX **PIXELMAX** RGBW

24V



⚡ 24V dc

Hz 50-60Hz

◇ CIII

⊙ IP65

⊠ NO INC.

⊞ 10ud



484886		

↔	1m
	10
W	20W
	Según Controlador

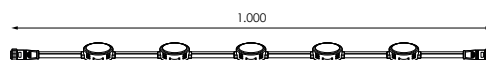

484879		

↔	5m
	50
W	92W
	Según Controlador

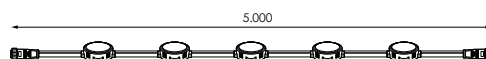

## Accesorios (NO Incluidos) / Accessoires (NOT Included) / Accessories (NON Inclusi)/ Acessórios (NÃO Incluso)

+ INFO PAG. 260

485135	Controlador Master DMX512 1 universo
488457	Fuente alimentación 60W 24V
485197	Conector a fuente alimentación
484978	Conector 5 DMX (1 entrada/6 salidas)
485166	Amplificador señal DMX 3 salidas

529037	Controlador Master DMX512 2 universos
488464	Fuente alimentación 100W 24V
484916	Conector T DMX (2 entradas/1 salida)
484923	Extensión 25cm DMX

485142	Controlador Master DMX512 8 universos
481687	Fuente alimentación 150W 24V
484954	Conector T DMX (1 entrada/2 salidas)
484930	Extensión 1m DMX

485159	Controlador Master DMX512 16 universos
481694	Fuente alimentación 200W 24V
484961	Conector 3 DMX (1 entrada/4 salidas)
484947	Extensión 3m DMX

## CONEXIÓN EN SERIE ESQUEMA INSTALACIÓN 1 UNIVERSO

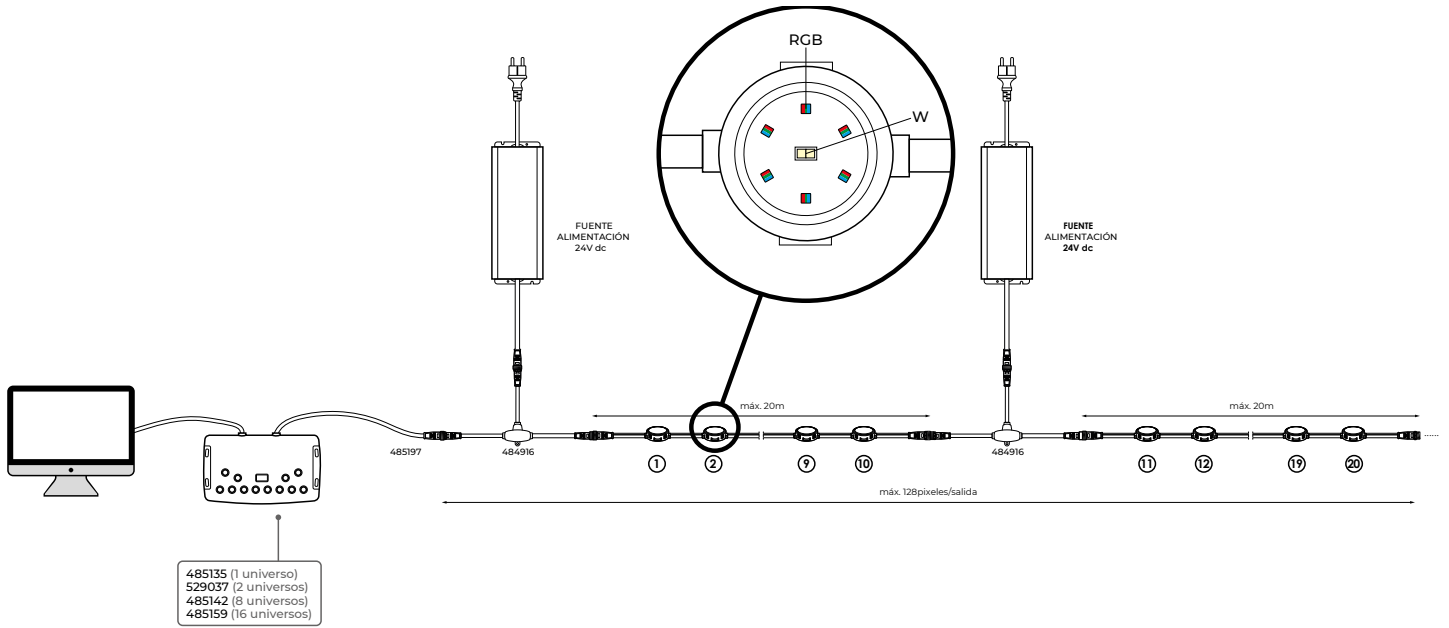

## CONEXIÓN EN PARALELO ESQUEMA INSTALACIÓN 1 UNIVERSO

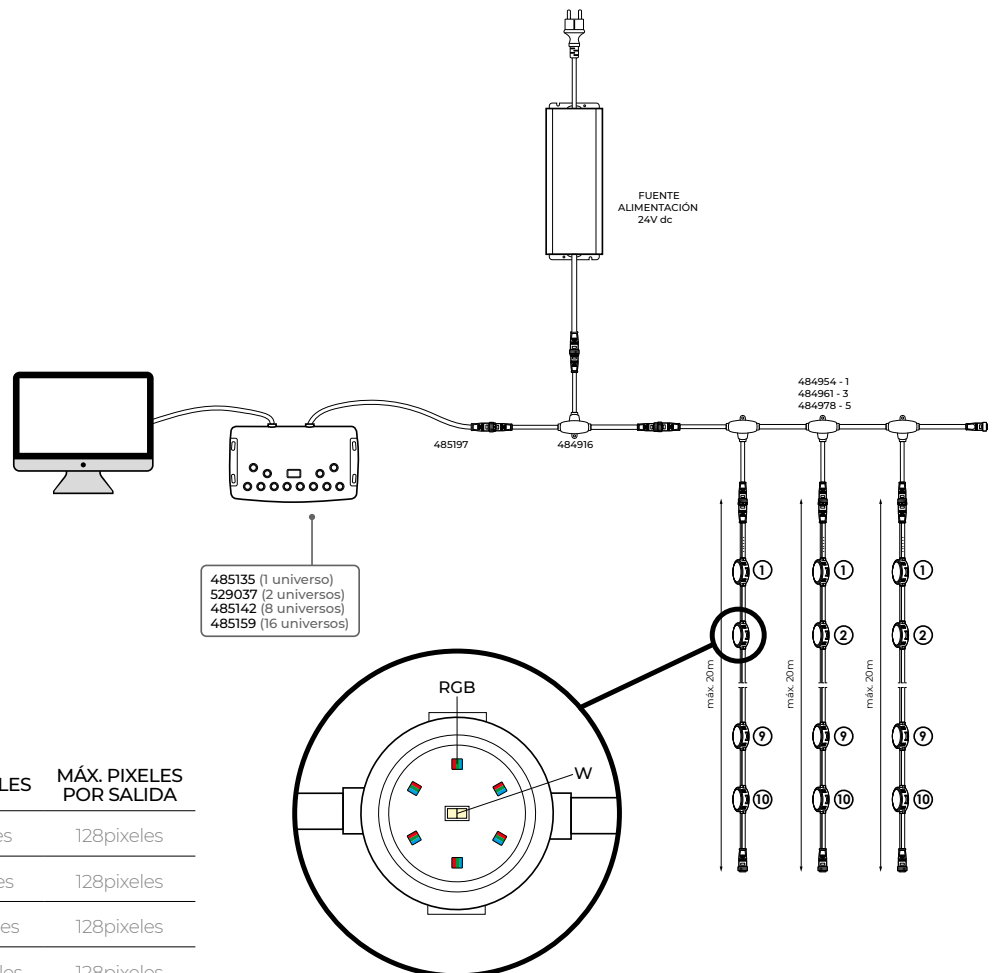

CÓDIGO CONTROLADOR	UNIVERSOS/SALIDAS	MÁX. PÍXELES	MÁX. PÍXELES POR SALIDA
485135	1 universo	128píxeles	128píxeles
529037	2 universos	256píxeles	128píxeles
485142	8 universos	1.024píxeles	128píxeles
485159	16 universos	2.048píxeles	128píxeles



# SCREEN PIXELMAX RGB

4x2m

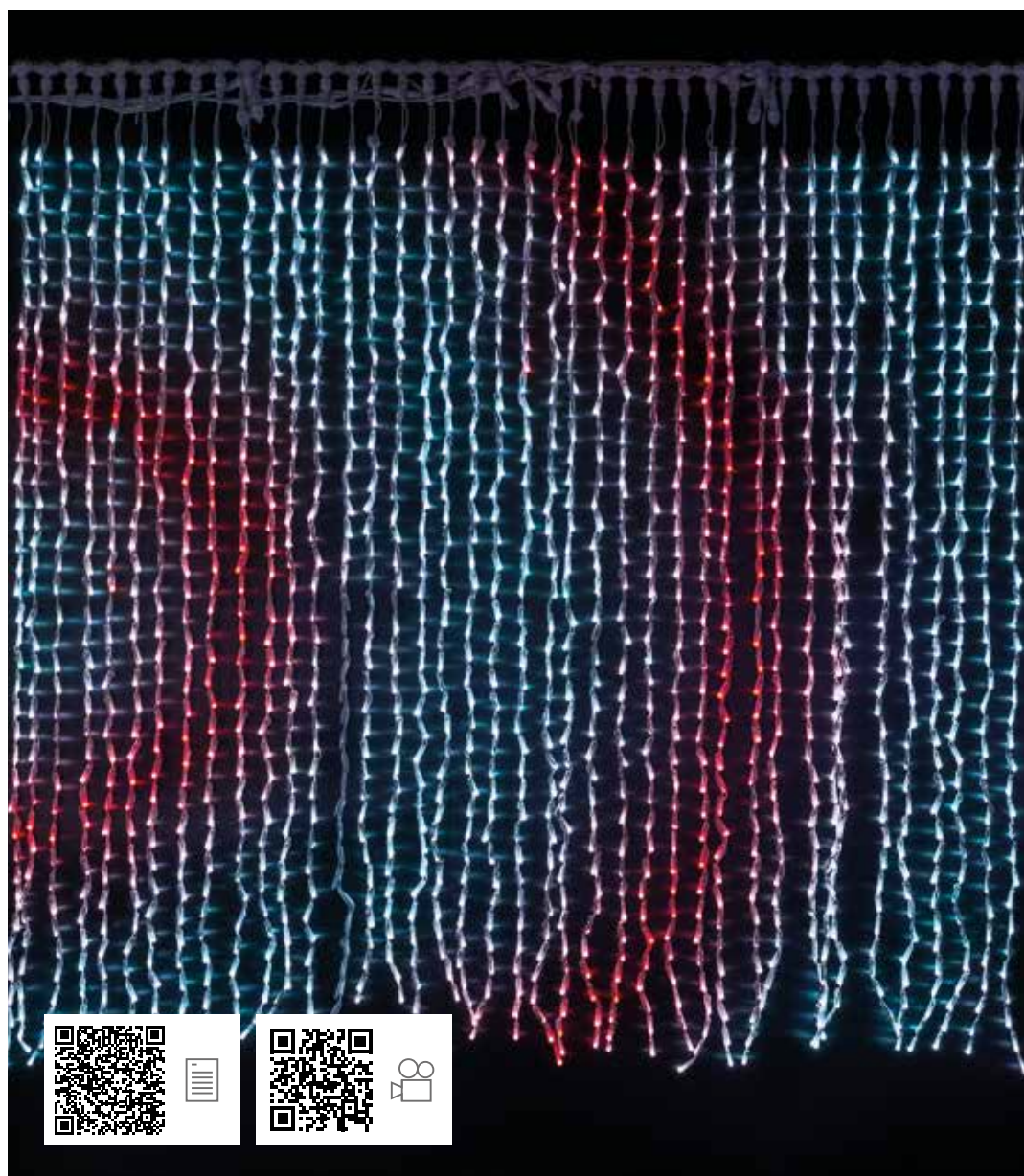

⚡ 66V dc

Hz 50-60Hz

☐ C11

☉ IP44

⚡ x8 PF-BOX

☐ Controlador esclavo

☐ Controlador master

⊞ 10ud

Ñ/ Cables de alimentación y caja estanca **INCLUIDOS**  
E/ Power cables and waterproof case **INCLUDED**  
F/ Câbles d'alimentation et boîtier étanche **INCLUS**  
P/ Cabos de alimentação e caixa à prova d'água **INCLUÍDO**

				4x2m
496780				80
				3200
				40
			W	528W

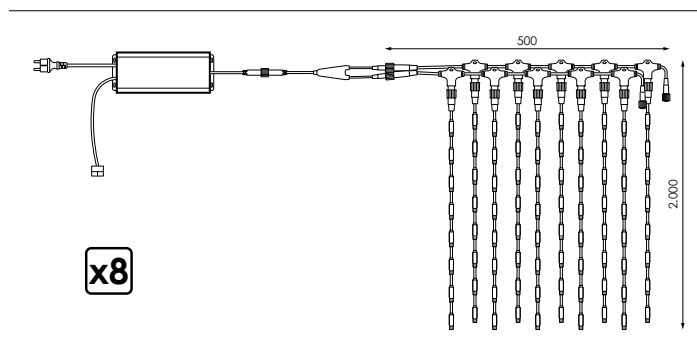

## Información/Information/Information/Informações

Ñ/ Se sirve con animación standard preprogramada.

E/ It is served with pre-programmed standard animation.

F/ Il est servi avec une animation standard préprogrammée.

P/ É servido com animação padrão pré-programada.

Conexión de un tramo 0,5m y PF BOX a controlador esclavo

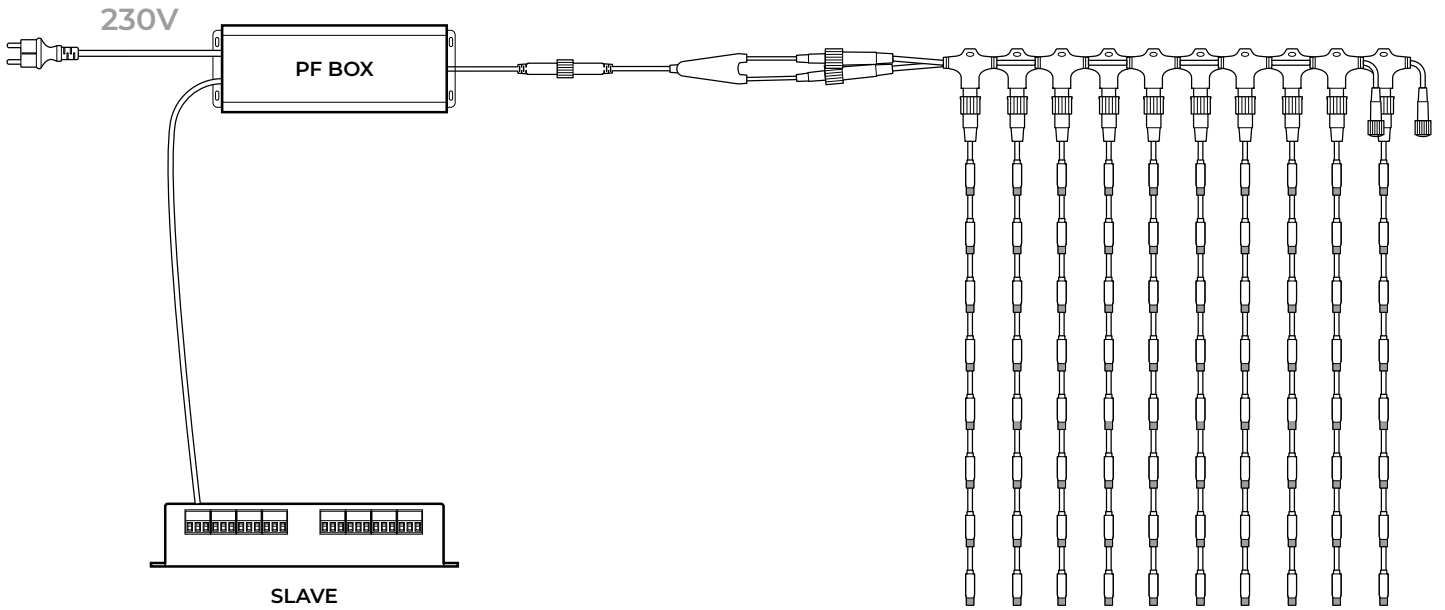

Tramo 4x2m

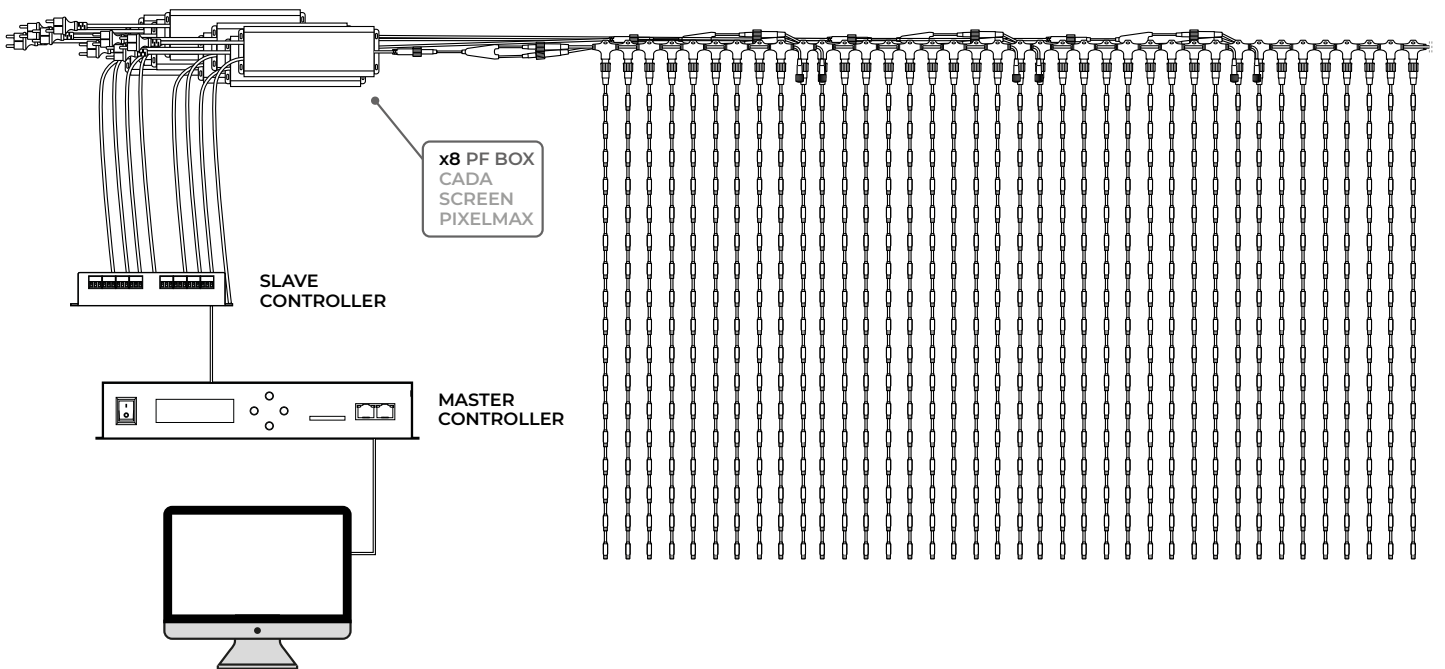

Aviso/Warning/Avertissement/Aviso

Ñ/ Esquema de instalación para Screen PIXELMAX de 4x2m (incluye controlador master y controlador esclavo). **Para ampliación de dimensiones (8x2m, 4x4m,...), consultar bajo pedido con el departamento de sistemas de control.**

E/ Installation diagram for Screen PIXELMAX 4x2m (includes master controller and slave controller). **To enlarge the dimensions (8x2m, 4x4m, ...), check on request with the control systems department.**

F/ Écran de veille pour écran PIXELMAX de 4x2m (comprend le contrôleur maître et le contrôleur esclave). **Para ampliación de dimensiones (8x2m, 4x4m, ...), vérifiez sur demande auprès du service des systèmes de contrôle.**

P/ Esquema de instalação para tela PIXELMAX de 4x2m (inclui controlador mestre e controlador esclavo). **Para ampliação de dimensões (8x2m, 4x4m, ...), verifique a pedido com o departamento de sistemas de controle.**

# MESH PIXELMAX RGBW

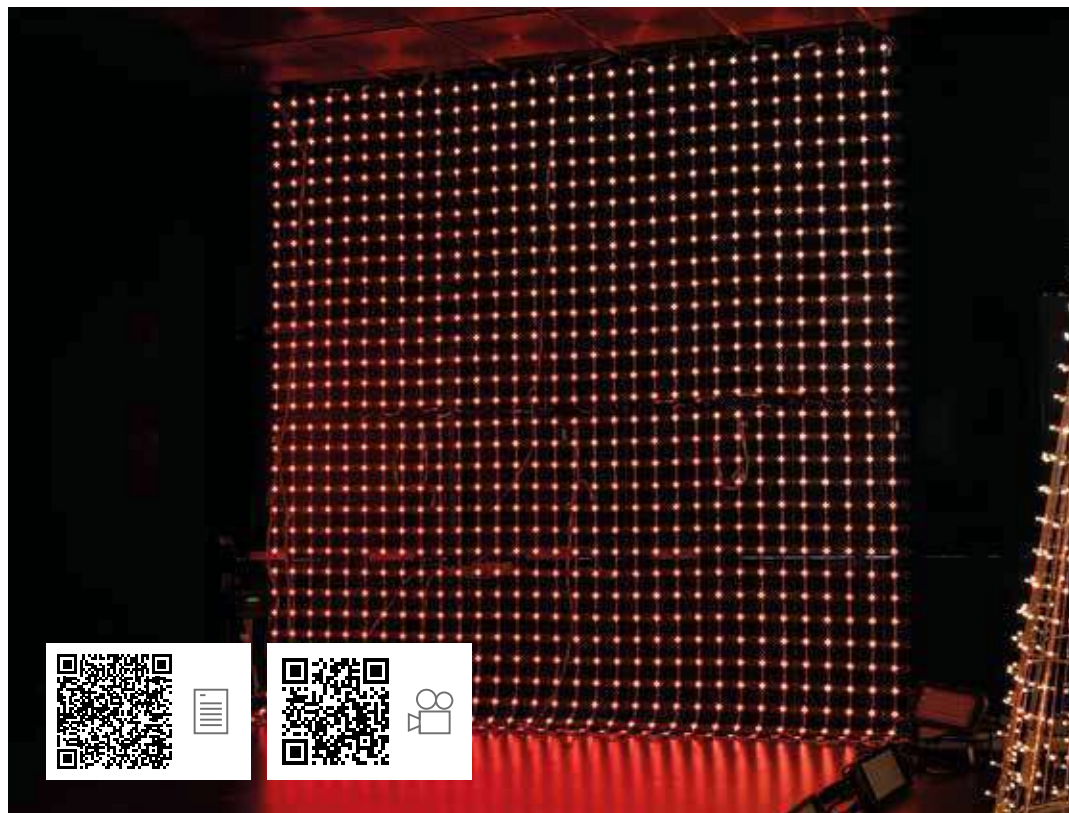

⚡ 24V dc

Hz 50-60Hz

◇ CIII

⊙ IP65

⊗ NO INC.

⊕ 1ud



566896

↕	80x160cm
⊙	8
💡	128
⊕	16
W	192W

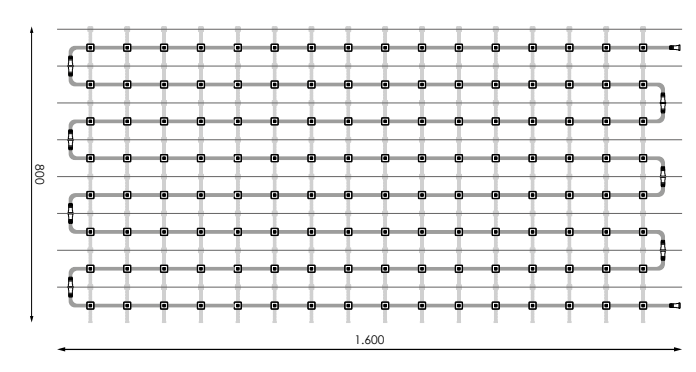

## Accesorios (NO Incluidos) / Accessoires (NOT Included) / Accessories (NON Inclus) / Acessórios (NÃO Incluso)

+ INFO PAG. 260

485173 Controlador Master SPI 4 salidas/4 universos	485180 Controlador Master SPI 4x2 salidas/8 universos	568968 Controlador Slave SPI 8x4 salidas/32 universos	567992 Conector T SPI (2 entradas/1 salida)
571968 Fuente alimentación 200W 24V	568982 Conector a controlador	569996 Cierre M4 para cable de acero	569989 Tensor para cable de acero
570350 Extensión 1m SPI	570367 Extensión 3m SPI	570374 Extensión 5m SPI	570381 Extensión 10m SPI

## Información/Information/Information/Informações

**N/** Se sirve con animación standard preprogramada.

**E/** It is served with pre-programmed standard animation.

**F/** Il est servi avec une animation standard préprogrammée.

**P/** É servido com animação padrão pré-programada.



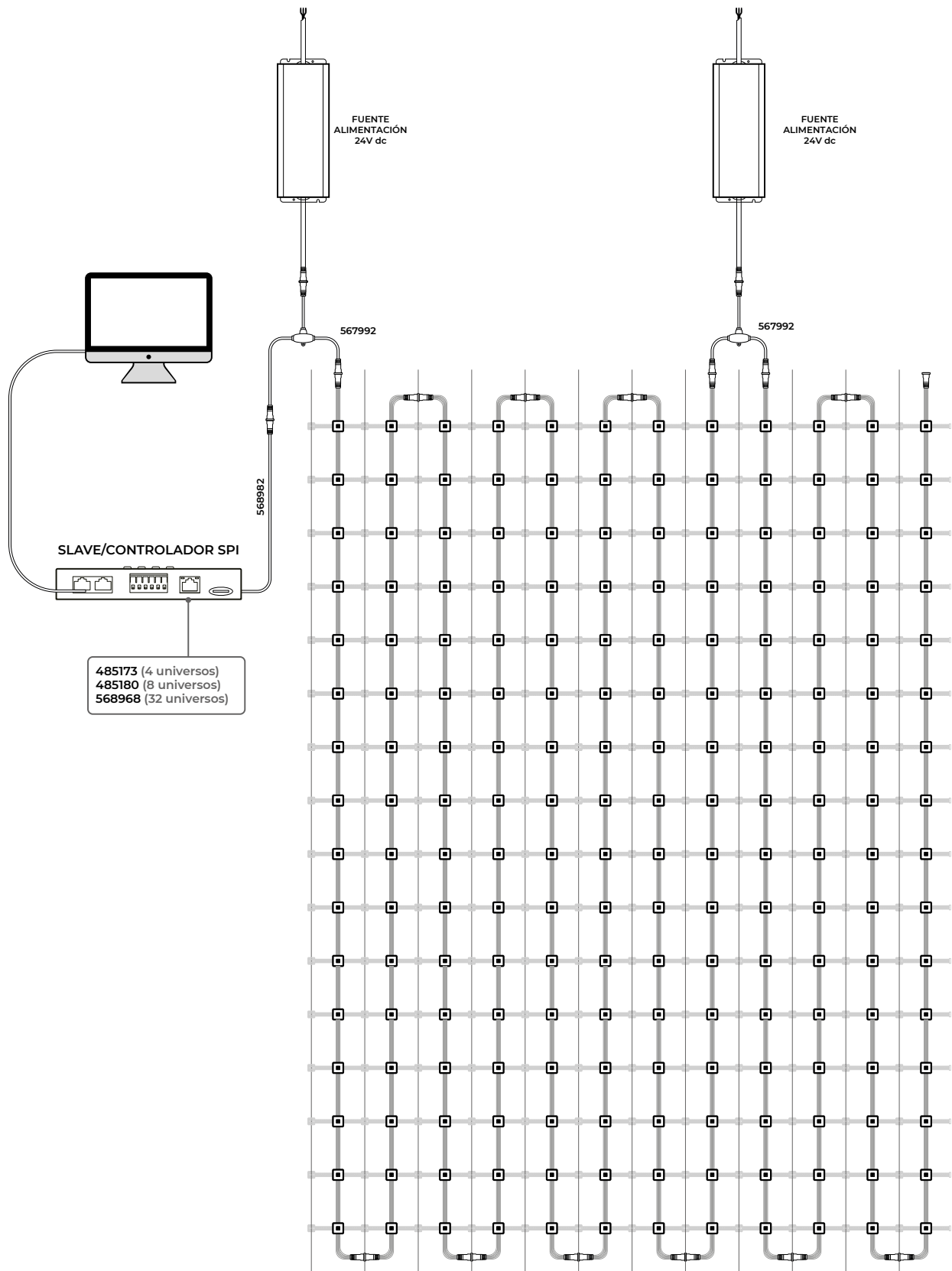

[GRÁFICOS: Unidades en mm/ GRAPPHICS: Units in mm/GRAPHIQUES: Unités en mm/GRÁFICOS: Unidades em mm]

Ñ/ Esquema de instalación para Mesh PIXELMAX. **Para ampliación de dimensiones, consultar bajo pedido con el departamento de sistemas de control.**

E/ Installation diagram for Mesh PIXELMAX. **To enlarge the dimensions, check on request with the control systems department.**

F/ Écran de veille pour Mesh PIXELMAX. **Para ampliación de dimensiones, vérifier sur demande auprès du service des systèmes de contrôle.**

P/ Esquema de instalação para Mesh PIXELMAX. **Para ampliação de dimensões, verifique a pedido com o departamento de sistemas de controle.**

Aviso/Warning/Avertissement/Aviso

# CONTROLADOR

## para productos estáticos

Una manera sencilla de añadir dinamismo a todos nuestros productos estáticos (230V) y crear espacios divertidos y con movimiento.

### CONTROLLER

for static products

A simple way to add dynamism to all our static products (230V) and create fun and moving spaces.

### CONTRÔLEUR

pour les produits statiques

Un moyen simple d'ajouter du dynamisme à tous nos produits statiques (230V) et de créer des espaces amusants et émouvants.

### CONTROLADOR

para produtos estáticos

Uma maneira simples de adicionar dinamismo a todos os nossos produtos estáticos (230V) e criar espaços divertidos e móveis.

### CONTROLADOR

2 canales DMX-TRIAC

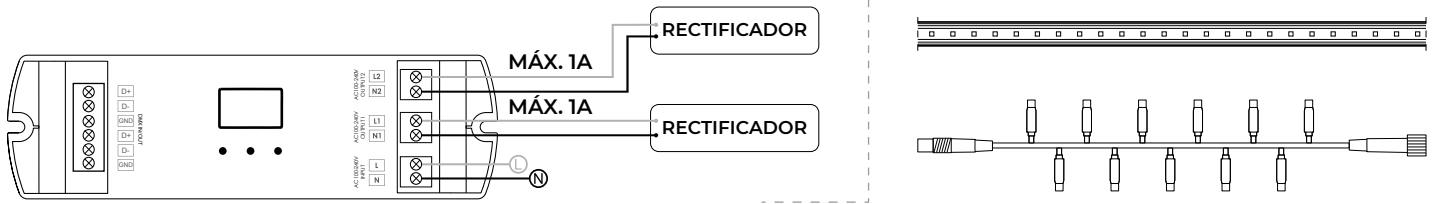

Accesorios (NO Incluidos) / Accessoires (NOT Included) / Accessories (NON Inclus)/ Acessórios (NÃO Incluso)  
+ INFO PAG. 260

451154	485135	529037	485142
Controlador DMX triac (2 canales)	Controlador Master DMX512 1 universo	Controlador Master DMX512 2 universos	Controlador Master DMX512 8 universos
485159	490641	490658	490665
Controlador Master DMX512-SPI 16 universos	Box control 2 salidas	Box control 6 salidas	Box control 10 salidas
485166	496902	493338	
Amplificador señal DMX	Caja estanca controlador DMX	Fuente alimentación 12V 15W	

### Aviso/Warning/Avertissement/Aviso

**N/** Estos productos son IP20 (excepto los box de control) y para instalaciones en exterior es necesaria una caja estanca.



**E/** These products are IP20 (except the control boxes) and for outdoor installations a watertight box is necessary.

**F/** Ces produits sont IP20 (sauf pour les boîtiers de commande) et pour les installations extérieures, un boîtier étanche est requis.

**P/** Esses produtos são IP20 (exceto para caixas de controle) e para instalações externas é necessária uma caixa estanque.





MOTIVO



Calle Alfonso I -  
ZARAGOZA



CALLE









# Accesorios (NO Incluidos)



Accessoires (NOT Included)

Accessories (NON Inclus)

Acessórios (NÃO Incluso)

		flexiLIGHT Maxibrillo RGB	flexiLIGHT Neon RGB	flexiLIGHT RGBWW	flexiLIGHT RGB	flexiLIGHT CW-WWW	STRING PLUS 100 RGBWW	STRING PLUS 100 RGB	STRING PLUS 100 CW-WWW	SCREENLIGHT RGB	SCREENLIGHT RGBWW	ICICLE RGB	ICICLE RGBWW	STRING PLUS 100 RGBWW 24V	STRING PLUS 100 RGB 24V (Fuente)	STRING PLUS 100 RGB 24V (Trafo)	STRING PLUS 100 CW-WWW 24V	STRING PIXELMAX	DOT DMX PIXELMAX	SCREEN PIXELMAX	MESH PIXELMAX	PRODUCTOS ESTATICOS 230V
	149198															•	•					
	193061																					
	193078																					
	481687													•	•				•			
	481694													•	•				•		•	
	484282																	•				
	488440													•	•							
	488457													•	•				•			
	488464													•	•				•			
	493338																					•
	563161																	•				
	451154																					•
	454261				•			•														
	472494																	•				
	485135								•						•					•		
	485142								•						•					•		
	485159																	•				
	485166								•						•		•	•	•			
	485173																	•			•	
	485180																	•			•	
	486262				•			•														
	486279				•			•														
	486309					•			•													
	486316					•			•													
	486323					•			•													
	486330					•			•													
	486408														•							
	486422																•					
	486439																•					
	486460																			•		
	490191																					
	490245																					
	490641																					•
	490658																					•
	490665																					•
	496445																	•				
	496902				•	•																•
	514491			•			•				•		•									
	514507			•			•				•		•									
	514514			•			•				•		•									
	529037																		•			•
	519236																	•				
	571845				•		•			•		•										
	566520			•			•				•		•									

		flexiLIGHT Maxibrillo RGB	flexiLIGHT Neon RGB	flexiLIGHT RGBWW	flexiLIGHT RGB	flexiLIGHT CW-WWW	STRING [PLUS] 100 RGBWW	STRING [PLUS] 100 RGB	STRING [PLUS] 100 CW-WWW	SCREENLIGHT RGB	SCREENLIGHT RGBWW	ICICLE# RGB	ICICLE# RGBWW	STRING [PLUS] 100 RGBWW 24V	STRING [PLUS] 100 RGB 24V (Fuente)	STRING [PLUS] 100 RGB 24V (Trafo)	STRING [PLUS] 100 CW-WWW 24V	STRING PIXELMAX	DOT DMX PIXELMAX	SCREEN PIXELMAX	MESH PIXELMAX	PRODUCTOS ESTÁTICOS 230V
	567992																					
	568562																					
	568968																					
	588874																					
	588881																					
	599894																					
	599917																					
	600705																					
	192323																					
	192347																					
	192354																					
	192361																					
	192378																					
	192385																					
	192392																					
	192408																					
	192415																					
	192422																					
	192439																					
	192446																					
	192453																					
	192477																					
	192484																					
	192491																					
	388368																					
	388375																					
	388382																					
	388399																					
	388498																					
	388504																					
	391498																					
	391504																					
	391535																					
	481700																					
	481717																					
	481724																					
	484299																					
	484305																					
	484312																					
	484312																					
	484329																					
	484336																					
	484343																					
	484350																					
	484367																					
	484916																					
	484923																					
	484930																					
	484947																					
	484954																					
	484961																					
	484978																					
	485197																					
	490207																					
	490214																					

		flexiLIGHT Maxibrillo RGB	flexiLIGHT Neon RGB	flexiLIGHT RGBWW	flexiLIGHT RGB	flexiLIGHT CW-WWW	STRING [PLUS] 100 RGBWW	STRING [PLUS] 100 RGB	STRING [PLUS] 100 CW-WWW	SCREENLIGHT RGB	SCREENLIGHT RGBWW	ICICLE# RGB	ICICLE# RGBWW	STRING [PLUS] 100 RGBWW 24V	STRING [PLUS] 100 RGB 24V (Fuente)	STRING [PLUS] 100 RGB 24V (Trafo)	STRING [PLUS] 100 CW-WWW 24V	STRING PIXELMAX	DOT DMX PIXELMAX	SCREEN PIXELMAX	MESH PIXELMAX	PRODUCTOS ESTÁTICOS 230V	
	490221																						
	490740								•						•		•	•	•	•			
	496735																	•	•	•			
	518154																	•	•	•			
	518161																	•	•	•			
	518178																	•	•	•			
	551779								•						•		•	•	•	•			
	567992																						
	569989																					•	
	569996																					•	
	600958		•																				
	600972	•																					
	971140														•								
	971188														•								
	971195														•								
	971201														•								
	971218														•								
	600941		•																				
	600965	•																					

#### EMPALME ESTANCO MAXIBRILLO

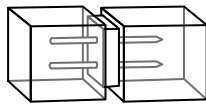

   
600972 T Transparente

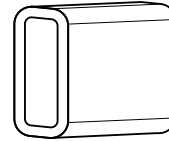

#### TAPA FINAL MAXIBRILLO

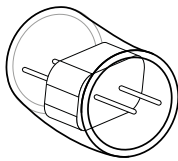

   
600965 T Transparente

#### EMPALME DOUBLE NEON



   
600958 Bl Blanco

#### TAPA FINAL DOUBLE NEON

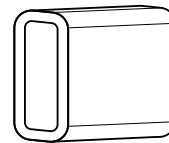

   
600941 T Transparente

#### CONTROLADOR FLEXILIGHT MAXIBRILLO RGB CON MANDO

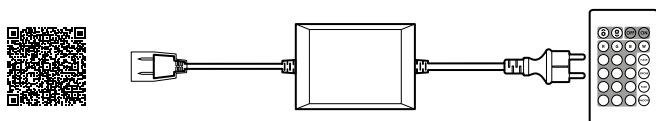

      
N 599917 230V IP44 Máx. 50m en línea

#### CONTROLADOR FLEXILIGHT DOUBLE NEON RGB CON MANDO

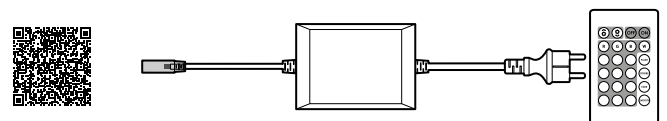

      
N 599894 230V IP44 Máx. 50m en línea



**CONTROLADOR RGBWW CON MANDO**

FLEXILIGHT-STRING PLUS-SCREENLIGHT-ICICLE

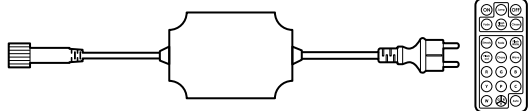

W

514514

230V

IP55

Paralelo: Máx. 4.000leds  
Serie: Máx. 3.600leds

Efecto memoria  
Memory effect  
Effet mémoire  
Efeito de memória

**CONTROLADOR POWER LINE RGBWW**

FLEXILIGHT-STRING PLUS-SCREENLIGHT-ICICLE

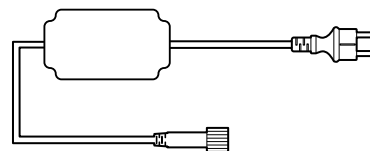

W

514507

230V

IP55

Paralelo: Máx. 4.000leds  
Serie: Máx. 3.600leds

Sincronización coordinada mediante una línea eléctrica. Cambio secuencial cada 15seg.  
Coordinated synchronization through an electrical panel. Sequential change every 15sec.  
Synchronisation coordonnée via un tableau électrique. Changement séquentiel toutes les 15s.  
Sincronização coordenada através de um painel elétrico. Mudança sequencial a cada 15seg.

**CONTROLADOR/PASARELA DMX RGBWW**

FLEXILIGHT-STRING PLUS-SCREENLIGHT-ICICLE

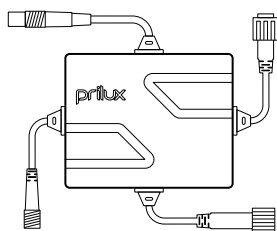

W

514491

230V

IP55

Paralelo: Máx. 4.000leds  
Serie: Máx. 3.600leds

Cambio secuencial cada 15seg. si no recibe señal DMX.  
Sequential change every 15sec. if you do not receive DMX signal.  
Changement séquentiel toutes les 15 secondes. si vous ne recevez pas de signal DMX.  
Mudança sequencial a cada 15 seg. se você não receber sinal DMX.

**SINCRONIZADOR GPS RGBWW**

FLEXILIGHT-STRING PLUS-SCREENLIGHT-ICICLE

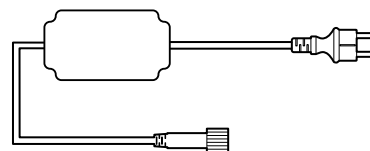

W

566520

230V

IP55

Paralelo: Máx. 4.000leds  
Serie: Máx. 3.600leds  
Max. 100m/línea

Sincronización mediante satélite GPS. Solo uso exterior. Cambio secuencial cada 15seg.  
GPS satellite synchronization. Only outside use. Sequential change every 15sec.  
Synchronisation satellite GPS. Seulement utilisation à l'extérieur. Changement séquentiel toutes les 15s.  
Sincronização por satélite GPS. Apenas fora de uso. Mudança sequencial a cada 15seg.

**CONTROLADOR RGB CON MANDO**

STRING PLUS-SCREENLIGHT-ICICLE

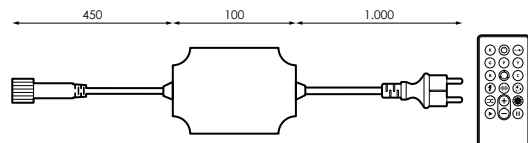

W

571845

230V

IP55

Máx. 2.000leds

Efecto memoria  
Memory effect  
Effet mémoire  
Efeito de memória

**CONTROLADOR RGB CON MANDO**

STRING PLUS-SCREENLIGHT-ICICLE

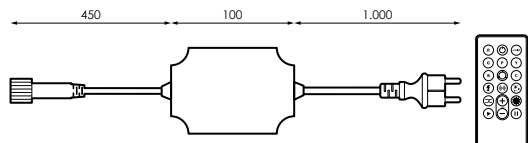

W

N 600705

230V

IP55

Paralelo: Máx. 4.000leds  
Serie: Máx. 3.600leds

Efecto memoria  
Memory effect  
Effet mémoire  
Efeito de memória

### CONTROLADOR POWER LINE RGB

FLEXILIGHT-STRING PLUS-SCREENLIGHT-ICICLE

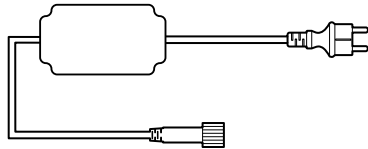

486262



230V



IP55

W

Max. 2.000leds

Sincronización coordinada mediante una línea eléctrica. Cambio secuencial cada 15seg.  
Coordinated synchronization through an electrical panel. Sequential change every 15sec.  
Synchronisation coordonnée via un tableau électrique. Changement séquentiel toutes les 15s.  
Sincronização coordenada através de um painel elétrico. Mudança sequencial a cada 15seg.

### CONTROLADOR/PASARELA DMX RGB

FLEXILIGHT-STRING PLUS

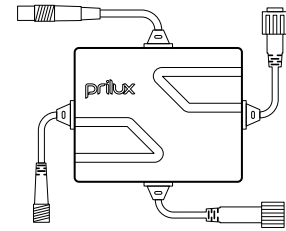

486279



230V



IP55

W

Max. 2.000leds

Cambio secuencial cada 15seg. si no recibe señal DMX. Sequential change every 15sec. if you do not receive DMX signal. Changement séquentiel toutes les 15 secondes. si vous ne recevez pas de signal DMX.  
Mudança sequencial a cada 15 seg. se você não receber sinal DMX.

### SINCRONIZADOR GPS RGB

FLEXILIGHT-STRING PLUS-SCREENLIGHT-ICICLE

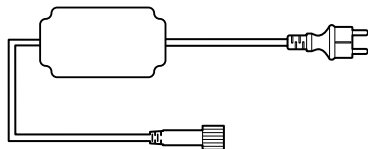

454261



230V



IP55

W

Max. 2.000leds

Sincronización mediante satélite GPS. Solo uso exterior. Cambio secuencial cada 15seg.  
GPS satellite synchronization. Only outside use. Sequential change every 15sec.  
Synchronisation satellite GPS. Seulement utilisation à l'extérieur. Changement séquentiel toutes les 15s.  
Sincronização por satélite GPS. Apenas fora de uso. Mudança sequencial a cada 15seg.

### CONTROLADOR CW-WW CON MANDO

FLEXILIGHT-STRING PLUS

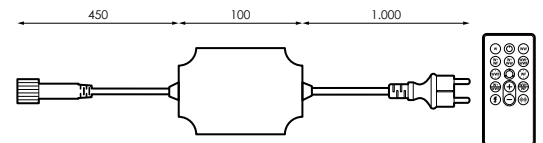

486309



230V



IP55

W

Max. 2.000leds

Efecto memoria  
Memory effect  
Effet mémoire  
Efeito de memória

### CONTROLADOR POWER LINE CW-WW

FLEXILIGHT-STRING PLUS

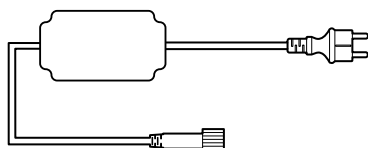

486323



230V



IP55

W

Max. 2.000leds

Sincronización coordinada mediante una línea eléctrica. Cambio secuencial cada 15seg.  
Coordinated synchronization through an electrical panel. Sequential change every 15sec.  
Synchronisation coordonnée via un tableau électrique. Changement séquentiel toutes les 15s.  
Sincronização coordenada através de um painel elétrico. Mudança sequencial a cada 15seg.

### SINCRONIZADOR GPS CW-WW

FLEXILIGHT-STRING PLUS

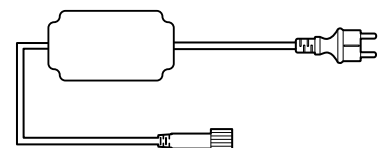

486316



230V



IP55

W

Max. 2.000leds

Sincronización mediante satélite GPS. Solo uso exterior. Cambio secuencial cada 15seg.  
GPS satellite synchronization. Only outside use. Sequential change every 15sec.  
Synchronisation satellite GPS. Seulement utilisation à l'extérieur. Changement séquentiel toutes les 15s.  
Sincronização por satélite GPS. Apenas fora de uso. Mudança sequencial a cada 15seg.

CONTROLADOR/PASARELA DMX CW-WW

FLEXILIGHT-STRING PLUS

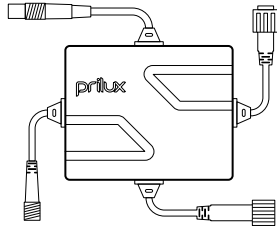

486330



230V



IP55

W

Max. 2.000leds

Cambio secuencial cada 15seg. si no recibe señal DMX.  
Sequential change every 15sec. if you do not receive DMX signal.  
Changement séquentiel toutes les 15 secondes. si vous ne recevez pas de signal DMX.  
Mudança sequencial a cada 15 seg. se você não receber sinal DMX.

CONTROLADOR RGB 24V CON MANDO

STRING PLUS

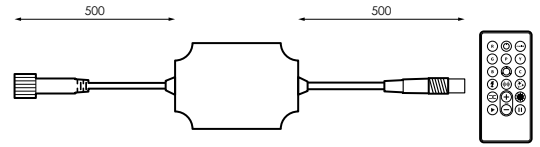

N 588881



24V



IP55

W

Paralelo: Máx. 850leds  
Serie: Máx. 500leds

Efecto memoria  
Memory effect  
Effet mémoire  
Efeito de memória

CONTROLADOR POWER LINE RGB 24V

STRING PLUS

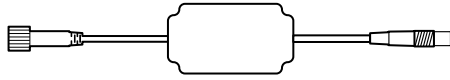

486408



24V



IP55

W

Max. 400leds

Sincronización coordinada mediante una línea eléctrica. Cambio secuencial cada 15seg.  
Coordinated synchronization through an electrical panel. Sequential change every 15sec.  
Synchronisation coordonnée via un tableau électrique. Changement séquentiel toutes les 15s.  
Sincronização coordenada através de um painel elétrico. Mudança sequencial a cada 15seg.

CONTROLADOR CW-WW 24V CON MANDO

STRING PLUS

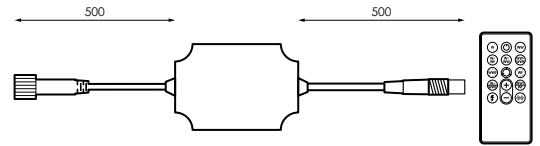

486422



24V



IP55

W

Max. 400leds

Efecto memoria  
Memory effect  
Effet mémoire  
Efeito de memória

CONTROLADOR POWER LINE CW-WW 24V

STRING PLUS

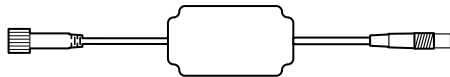

486439



24V



IP55

W

Max. 400leds

Sincronización coordinada mediante una línea eléctrica. Cambio secuencial cada 15seg.  
Coordinated synchronization through an electrical panel. Sequential change every 15sec.  
Synchronisation coordonnée via un tableau électrique. Changement séquentiel toutes les 15s.  
Sincronização coordenada através de um painel elétrico. Mudança sequencial a cada 15seg.

CONTROLADOR RGBWW 24V CON MANDO

STRING PLUS

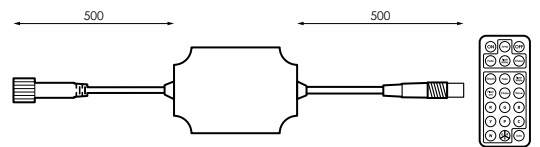

N 588874



24V



IP55

W

Paralelo: Máx. 850leds  
Serie: Máx. 500leds

Efecto memoria  
Memory effect  
Effet mémoire  
Efeito de memória



### FUENTE ALIMENTACIÓN 12V

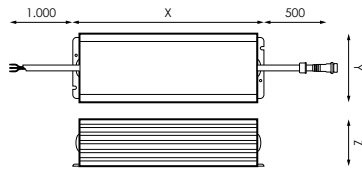

			<b>W</b>		
484282	12V	IP66	60W	195 x 46 x 32mm	1 salida
563161	12V	IP66	250W	273 x 73 x 44mm	4 salidas

### FUENTE ALIMENTACIÓN 24V

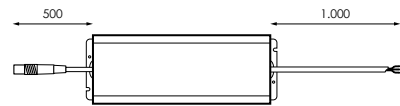

			<b>W</b>			
488440	170-240V	24V	30W	IP66/ IP44 Plug	202 x 34 x 36mm	1 salida
488457	170-240V	24V	60W	IP66/ IP44 Plug	197 x 45 x 32mm	1 salida
488464	170-240V	24V	100W	IP66/ IP44 Plug	248 x 45 x 32mm	1 salida
481687	100-240V	24V	150W	IP66/ IP44 Plug	230 x 63 x 39mm	1 salida
481694	100-240V	24V	200W	IP66/ IP44 Plug	260 x 73 x 45mm	2 salidas

### EXTENSIÓN

STRING PIXELMAX

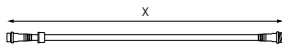

484312	0,25m		IP65
518154	0,50m		IP65
484329	1m		IP65
484336	3m		IP65
518161	5m		IP65
518178	10m		IP65

### CONECTOR-FUENTE ALIMENTACIÓN

STRING PIXELMAX

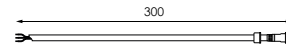

484305		CII	IP66

### CONECTOR T ENTRADA

STRING PIXELMAX

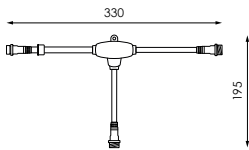

484299		IP65

### CONECTOR T

STRING PIXELMAX

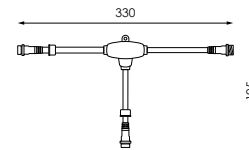

484343		IP65

### CONECTOR 3

STRING PIXELMAX

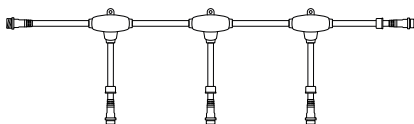

484350		IP65

### CONECTOR 5

STRING PIXELMAX

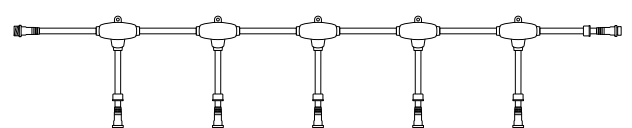

484367		IP65

[GRÁFICOS: Unidades en mm/ GRAPHICS: Units in mm/ GRAPHIQUES: Unités en mm/ GRÁFICOS: Unidades em mm]

TAPA FINAL

STRING PIXELMAX



594738



CONECTOR-FUENTE ALIMENTACIÓN

DOT DMX PIXELMAX

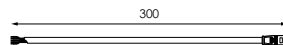

485197



CII

IP66

EXTENSIÓN

DOT DMX PIXELMAX

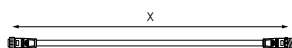

484923

0,25m



IP65

484930

1m



IP65

484947

3m



IP65

CONECTOR 5

DOT DMX PIXELMAX

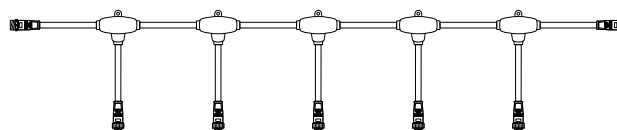

484978



IP65

CONECTOR T ENTRADA

DOT DMX PIXELMAX

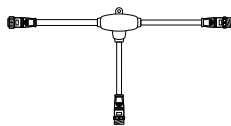

484916



IP65

CONECTOR T

DOT DMX PIXELMAX

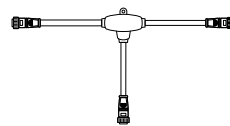

484954



IP65

CONECTOR 3

DOT DMX PIXELMAX/MESH PIXELMAX

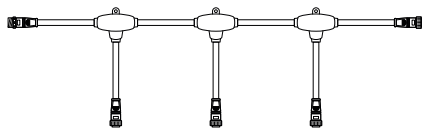

484961



IP65

TENSOR

MESH PIXELMAX



569989



Acero

CIERRE M4

MESH PIXELMAX



569996



Acero

CONECTOR T ENTRADA

MESH PIXELMAX

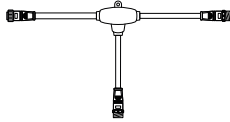

567992



IP65

CONTROLADOR SPI

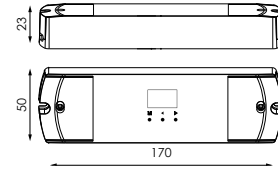

472494



100-240V



IP20



170 x 50 x 23mm

CONTROLADOR/SLAVE SPI

8 SALIDAS/32 UNIVERSOS

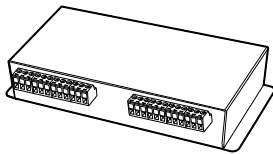

568968



5~24V dc



IP20



Max. 5.440 pixeles

CONTROLADOR SPI

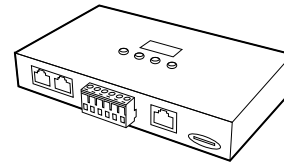

485173



5~24V dc



IP20



4 Salidas/  
Max. 680 pixeles

485180

5~24V dc

IP20

4x2 Salidas/  
Max. 1.360 pixeles

CONTROLADOR SPI-DMX

16 SALIDAS/UNIVERSOS

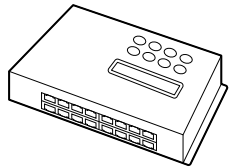

485159

12V dc

IP20

SPI - Max. 21.760 pixeles

DMX - Max. 2.048 pixeles

CONTROLADOR DMX

8 UNIVERSOS

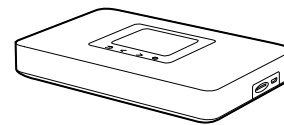

485142

5V dc

IP20

Max. 1.024 pixeles

CONTROLADOR DMX

2 UNIVERSOS

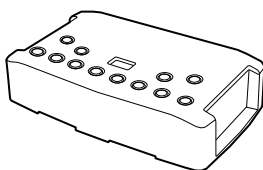

529037

9~36V dc

IP20

Max. 256 pixeles

CONTROLADOR DMX

1 UNIVERSO

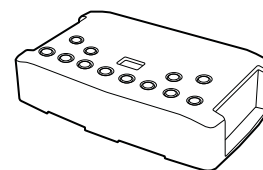

485135

9~36V dc

IP20

Max. 128 pixeles



[GRÁFICOS: Unidades en mm/ GRÁFICOS: Units in mm/ GRAPHIQUES: Unités en mm/ GRÁFICOS: Unidades em mm]

**CONTROLADOR DMX**

2 CANALES

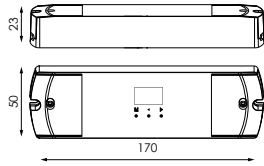

	451154	100-240V	Max. 220W	CII	IP20	2x1A

FUNCIONES/FUNCTIONS/FONCTIONS/FUNÇÕES

Modo de regulación 2 canales automático. Modo dinámico automático. Modo decodificación DMX.	Automatic 2 channel regulation. Mode automatic dynamic. DMX decoding mode.	Mode de régulation à 2 canaux. Mode dynamique automatique. Mode de décodage DMX	Modo de regulação automática de 2 canais. Modo dinâmico automático. Modo de decodificação DMX
---	--	--	---

**DIRECCIONADOR DMX**

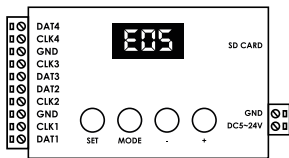

490245	IP20

**CONTROLADOR SLAVE**

SCREEN PIXELMAX

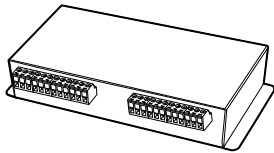

486460	66V	IP20	Max. 3200 pixels

**BOX MASTER SPI**

4 SALIDAS

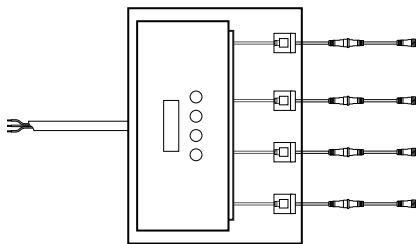

519236	IP65

**AMPLIFICADOR DMX**

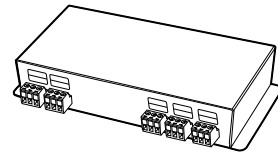

485166	12V dc	IP20

**PF BOX**

SCREEN PIXELMAX

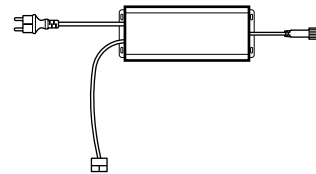

486477	66V	66W

**CAJA ESTANCA**

CON CONTROLADOR DMX 1 UNIVERSO

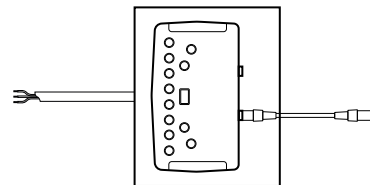

496902	IP65

**BOX MASTER SPI**

4x2 SALIDAS

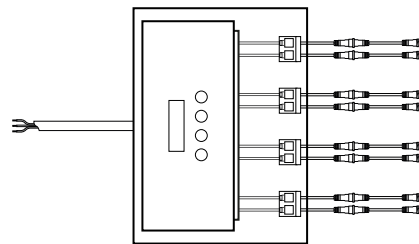

568562	IP65

BOX MASTER SPI

16 SALIDAS

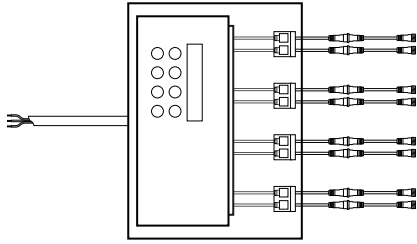

496445



IP65

BOX CONTROL PARA PRODUCTOS ESTÁTICOS

2 SALIDAS

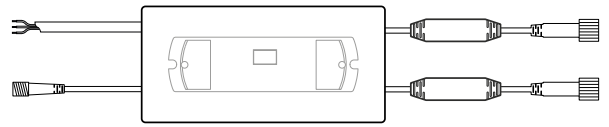

490641



IP65

BOX CONTROL PARA PRODUCTOS ESTÁTICOS

6 SALIDAS

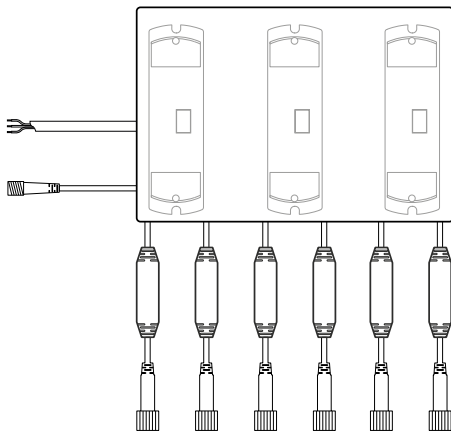

490658



IP65

BOX CONTROL PARA PRODUCTOS ESTÁTICOS

10 SALIDAS

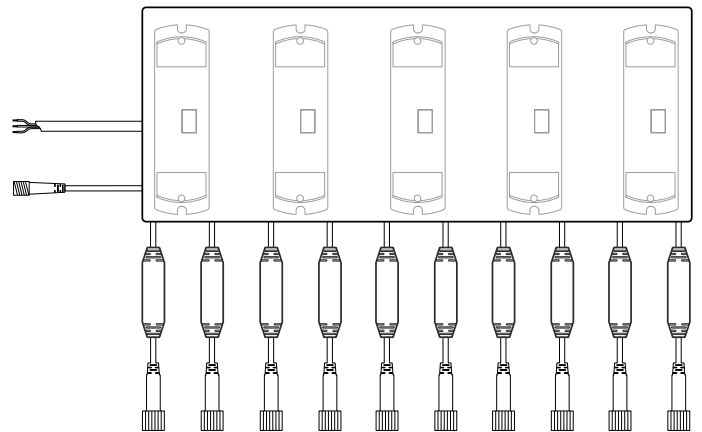

490665



IP65

MANGUERA DMX

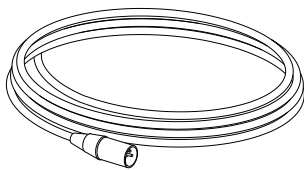

551779



rollo 100m

CABLE ETHERNET CON ADAPTADOR RJ4

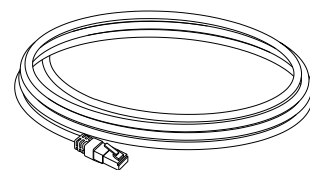

496735



25cm

CABLE ETHERNET

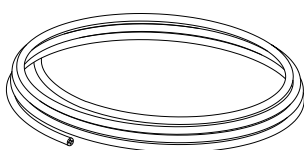

490740



1m

CABLE ALIMENTACIÓN

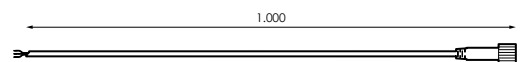

490191



1m



EXTENSIÓN DMX

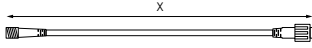

	↔	⊗	⊙
490207	1m	⊗	IP44
490214	3m	⊗	IP44
490221	5m	⊗	IP44

ADAPTADOR SMART LINK

SMART-FLEXILIGHT

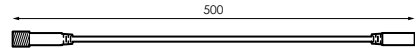

A

	⊗	⊙	⊙
192477	⊗	⊙	IP65
192453	⊗	⊙	IP65

Termoretractil y conector macho **NO INCLUIDOS**  
 Heat-shrinkable and male connector **NOT INCLUDED**  
 Thermorétractable et connecteur mâle **NON INCLUS**  
 Tubo de contração térmica e conector macho **NÃO INCLUÍDO**



Mercat de Sants  
Barcelona







Flexilight

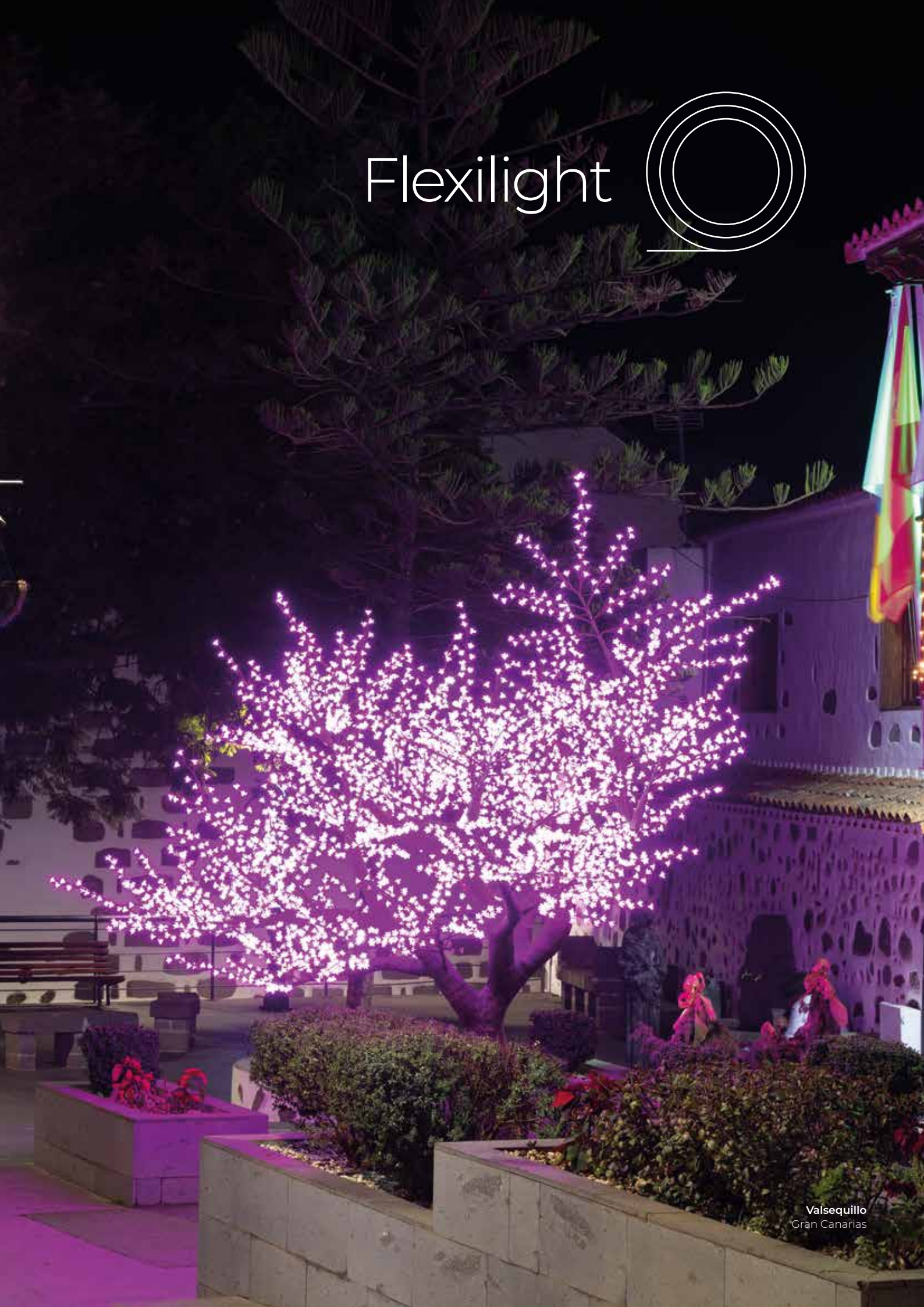

# flexiLIGHT Led

24V



Rota  
Cádiz

⚡ 24V dc

Hz 50-60Hz

◇ CIII

⊙ IP44 PLUG

IP54

△ 360°

🌡 -20°C~+60 °C

📊 5,5kg (N.W.)

⊗ NO INC.

⊗ NO INC.

🌀 Rollo 30m

Ñ/ Exterior/Textura Lisa/Tapa final **INCLUIDA**  
E/ Outside/Smooth Texture/End cover **INCLUDED**  
F/ A L'exterieur/Texture Lisse/Couvercle **INCLUS**  
P/ Exterior/Textura Lisa/Tampa final **INCLUIDA**

149167		
146432		
191876		
191883		
191906		
191913		

	16,6cm
∅	13mm
	36
W%	0,25W
W	45W
	Max. 30m
	Rollo 30m

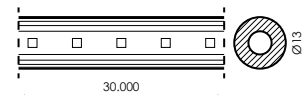

ESQUEMA INSTALACIÓN/  
INSTALLATION SCHEME/  
SCHEMA D'INSTALLATION/  
ESQUEMA DE  
INSTALAÇÃO



Producto/Product  
Produit/Produto

## Aviso/Warning/Avertissement/Aviso

Ñ/ Uso **OBLIGATORIO** de fuente de alimentación y adaptador.

E/ You **MUST USE** the power supply and adapter.

F/ L'utilisation **OBLIGATOIRE** du alimentation et adaptateur.

P/ Uso **OBRIGATÓRIO** de fonte de alimentação e adaptador.

## Accesorios (NO Incluidos) / Accessoires (NOT Included) / Accessories (NON Inclus)/ Acessórios (NÃO Incluso)

+ INFO PAG. 292

Ñ/ Fuente de alimentación y adaptador **NO INCLUIDA**

E/ Power supply and adapter **NOT INCLUDED**

F/ Alimentation et adaptateur **NON INCLUSE**

P/ Fonte de alimentação e adaptador **NÃO INCLUIDO**

488440

Fuente alimentación 30W 24V

488464

Fuente alimentación 100W 24V

481694

Fuente alimentación 200W 24V

488457

Fuente alimentación 60W 24V

481687

Fuente alimentación 150W 24V

194556

Adaptador



# flexiLIGHT Led

## 24V Flashing

	24V dc
<b>Hz</b>	50-60Hz
	CIII
	IP44 PLUG
	IP54
	360°
	-20°C~+60 °C
	5,5kg (N.W.)
	NO INC.
	NO INC.
	Rollo 30m



Cuidad de Braga 2020  
by AM Illumination  
Producto Prilux

Ñ/ Exterior/Textura Lisa/Tapa final **INCLUIDA**  
E/ Outside/Smooth Texture/End cover **INCLUDED**  
F/ À L'exterieur/Texture Lisse/Couvercle **INCLUS**  
P/ Exterior/Textura Lisa/Tampa final **INCLUÍDA**

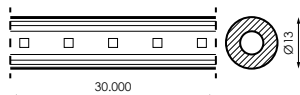

ESQUEMA INSTALACIÓN/  
INSTALLATION SCHEME/  
SCHÉMA D'INSTALLATION/  
ESQUEMA DE  
INSTALAÇÃO



	16,6cm
	13mm
	30+6 flashing
	0,25W
<b>W</b>	45W
	Max. 30m
	Rollo 30m

545761		
545778		

### Aviso/Warning/Avertissement/Aviso

Ñ/ Uso **OBLIGATORIO** de fuente de alimentació y adaptador.

E/ You **MUST USE** the power supply and adapter.

F/ L'utilisation **OBLIGATOIRE** du alimentation et adaptateur.

P/ Uso **OBRIGATÓRIO** de fonte de alimentação e adaptador.

Accesorios (NO Incluidos) / Accessoires (NOT Included) / Accessories (NON Inclus)/ Acessórios (NÃO Incluso)  
+ INFO PAG. 292

Ñ/ Fuente de alimentación y adaptador **NO INCLUIDA**

E/ Power supply and adapter **NOT INCLUDED**

F/ Alimentation et adaptateur **NON INCLUSE**

P/ Fonte de alimentação e adaptador **NÃO INCLUÍDO**

488440	Fuente alimentación 30W 24V
488464	Fuente alimentación 100W 24V
481694	Fuente alimentación 200W 24V

488457	Fuente alimentación 60W 24V
481687	Fuente alimentación 150W 24V
194556	Adaptador

# flexiLIGHT Led

## Bombilla Horizontal



	230V ac
<b>Hz</b>	50-60Hz
	CII
	1 Canal/ 2 Vías
	IP44 PLUG
	IP65
	360°
	-20°C~+60 °C
	7,8kg (N.W.)
	INC.
	Rollo 45m

Ñ/ Exterior/Textura Lisa/Tapa final **INCLUIDA**  
 E/ Outside/Smooth Texture/End cover **INCLUDED**  
 F/ A L'exterior/Texture Lisse/ Couvercle **INCLUS**  
 P/ Exterior/Textura Lisa/Tampa final **INCLUIDA**

CC. L'illa  
Barcelona

952750		
995078		
995085		
952767		
952781		
952774		
952798		
191814		
191807		
952811		
961158		
150316		

	1m
	13mm
	36
	3W
<b>W</b>	135W
	Max. 90m
	Rollo 45m

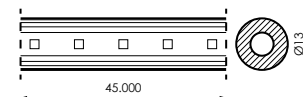

Accesorios (NO Incluidos) / Accessoires (NOT Included) / Accessories (NON Inclus) / Acessórios (NÃO Incluso)

+ INFO PAG. 292

952828  
Cable alimentación Negro

150330  
Cable alimentación Blanco



# flexiLIGHT Led

## Flashing

	230V ac
<b>Hz</b>	50-60Hz
	CII
	1 Canal/ 2 Vías
	IP44 PLUG
	IP65
	360°
	-20°C~+60 °C
	7,9kg (N.W.)
	INC.
	Rollo 45m



**N**/ Exterior/Textura Lisa/**Tapa final INCLUIDA**  
**E**/ Outside/Smooth Texture/**End cover INCLUDED**  
**F**/ À L'exterieur/Texture Lisse/**Couvercle INCLUS**  
**P**/ Exterior/Textura Lisa/**Tampa final INCLUÍDA**

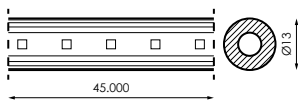

	1,5m			
	13mm	484190		
	30+6 flashing	970853		
	3,5W *4,2W	953368		
<b>W</b>	105W *125W	386944		
	Max. 90m	386951		
	Rollo 45m	386968*		
		386975*		
		386982		
		386999		

Accesorios (NO Incluidos) / Accessoires (NOT Included) / Accessories (NON Inclus) / Acessórios (NÃO Incluso)  
 + INFO PAG. 292

952828

Cable alimentación Negro

150330

Cable alimentación Blanco



# flexiLIGHT Led

## Bombilla Vertical

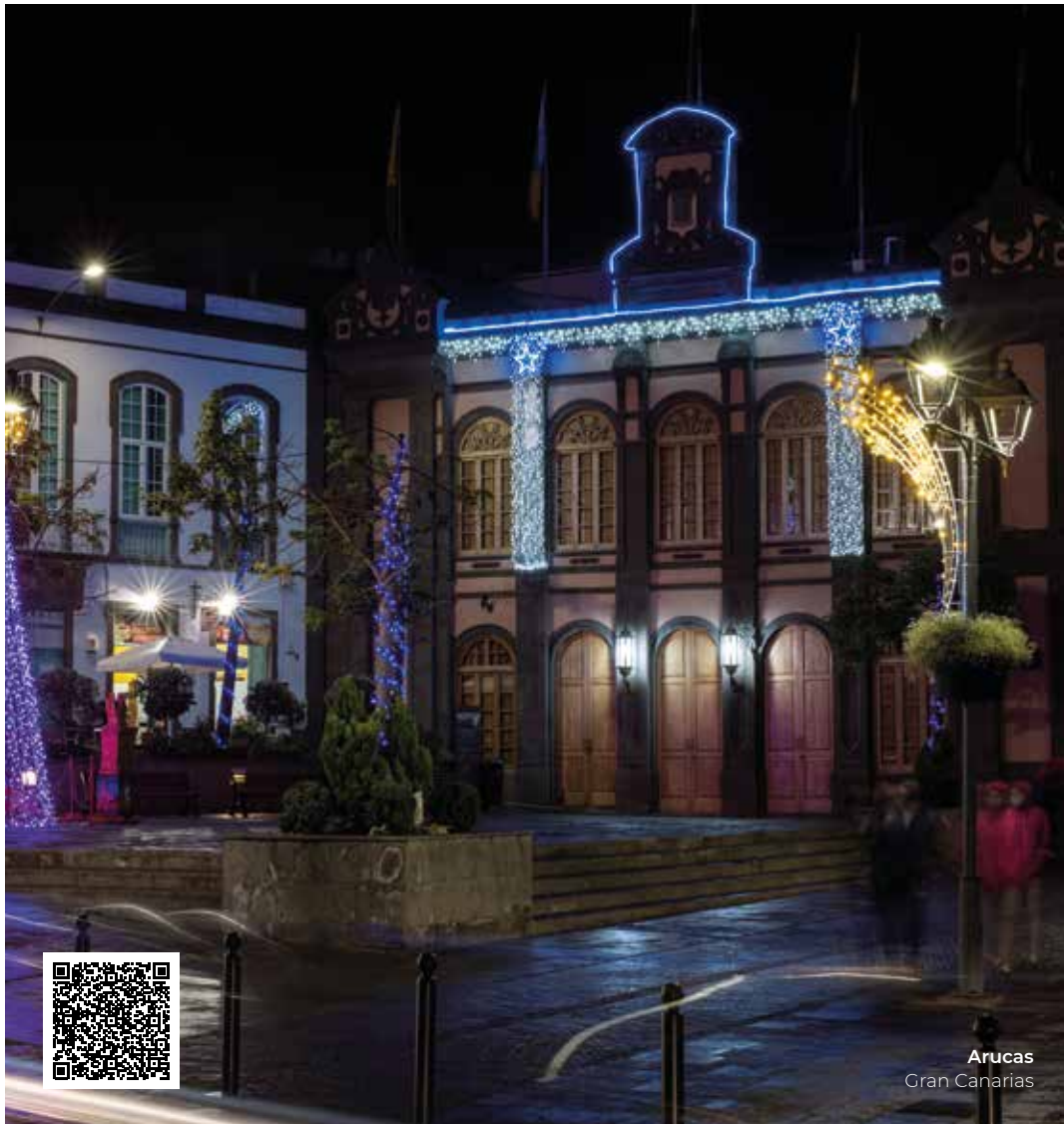

Arucas  
Gran Canarias

⚡ 230V ac

Hz 50-60Hz

□ CII

☺ 1 Canal/ 2 Vías

⊙ IP44 PLUG

⊙ IP65

∠ 120°

🌡 -20°C~+60 °C

📊 8kg (N.W.)

🍷 INC.

📦 Rollo 45m

Ñ/ Exterior/Textura Lisa/Tapa  
final **INCLUIDA**  
E/ Outside/Smooth Texture/End  
cover **INCLUDED**  
F/ A L'exterieur/Texture Lisse/  
Couvercle **INCLUS**  
P/ Exterior/Textura Lisa/Tampa  
final **INCLUIDA**



	💡	⊙
163347	LED	🔍
163392	LED	🔍
163354	LED	🔍
163378	LED	🔍
163385	LED	🔍
163361	LED	🔍

✂	1,5m
∅	13mm
💡	36
W/⊕	3,5W
W	105W
🔗	Max. 90m
⊙	Rollo 45m

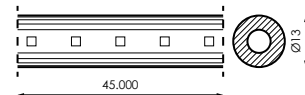

Accesorios (NO Incluidos) / Accessoires (NOT Included) / Accessories (NON Inclus) / Acessórios (NÃO Incluso)

+ INFO PAG. 292

952828

Cable alimentación Negro

150330

Cable alimentación Blanco

# flexiLIGHT Led

## Dual

	230V ac
	50-60Hz
	CII
	IP44 PLUG
	IP54
	360°
	-20°C~+60 °C
	8kg (N.W.)
	INC.
	Rollo 45m



El Pozo  
Alama de Murcia

**Ñ/ Exterior/Textura Lisa/Tapa final INCLUIDA**  
**E/ Outside/Smooth Texture/End cover INCLUDED**  
**F/ À L'exterieur/Texture Lisse/ Couvercle INCLUS**  
**P/ Exterior/Textura Lisa/Tampa final INCLUIDA**

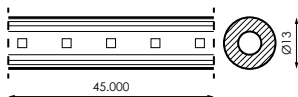

	1m			
	13mm	191821		
	36			
	3W			
	135W			
	Ver acces.			
	Rollo 45m			

### Aviso/Warning/Avertissement/Aviso

**Ñ/** Los efectos de cambio de color solo funcionan con el controlador que es de **USO OBLIGATORIO**.

**E/** The color change effects only work with the controller that is **OBLIGATORY**.

**F/** Les effets de changement de couleur fonctionnent uniquement avec le contrôleur qui est **OBLIGATOIRE**.

**P/** Os efeitos de mudança de cor funcionam apenas com o controlador que é **USO OBRIGATÓRIO**.

### Accesorios (NO Incluidos) / Accessoires (NOT Included) / Accessories (NON Inclus) / Acessórios (NÃO Incluso)

+ INFO PAG. 292

**Ñ/** La máxima longitud por alimentación, dependerá del controlador a utilizar.

**E/** Maximum length for power, will depend on the driver to use.

391559

Controlador dual 8 Funciones (Necesita adaptador)

194556

Adaptador 24V a Flexilight

971072

Controlador dual 4 Funciones (Necesita adaptador)

**F/** Longueur maximale pour le pouvoir, dépendra le pilote à utiliser.

**P/** Comprimento máximo para o poder, vai depender do driver para uso.

# flexiLIGHT Led Avant

IP67



Plaza Lagos  
Ecuador

⚡ 230V ac

Hz 50-60Hz

□ CII

⊙ 1 Canal/ 2 Vías

⊙ IP44 PLUG

⊙ IP67

∠ 360°

🌡️ -20°C~+60 °C

📊 8,3kg (N.W.)

🔌 INC.

📦 Rollo 45m

Ñ/ Exterior/Textura Lisa/Tapa final **INCLUIDA**  
E/ Outside/Smooth Texture/End cover **INCLUDED**  
F/ À L'extérieur/Texture Lisse/Couvercle **INCLUS**  
P/ Exterior/Textura Lisa/Tampa final **INCLUIDA**



488655		
488662		
488679		
488686		
488693		

	1m
∅	13mm
	36
W%	3W
W	135W
	Max. 90m
⊙	Rollo 45m

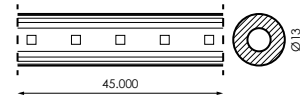

## Aviso/Warning/Avertissement/Aviso

Ñ/ Para que la conexión a la línea eléctrica sea IP67, la alimentación deberá ir en caja estanca. Perdida de IP al cortar el producto.

E/ In order for the connection to the powerline to be IP67, the power supply must be in a sealed box. Loss of IP when cutting the product.

F/ Pour que la connexion à la ligne électrique soit IP67, l'alimentation doit être dans un boîtier scellé. Perte de propriété intellectuelle lors de la découpe du produit.

P/ Para que a conexão à linha de energia seja IP67, a fonte de alimentação deve estar em uma caixa selada. Perda de IP ao cortar o produto.

Accesorios (NO Incluidos) / Accessoires (NOT Included) / Accessories (NON Inclus) / Acessórios (NÃO Incluso)

+ INFO PAG. 292

487184

Cable alimentación Negro

487191

Cable alimentación Blanco





Zaragoza

# flexiLIGHT Led

Neon



Hasta 5 años de garantía.  
Ver condiciones de uso  
**Up to 5 years of warranty**  
See terms of use  
**Jusqu'à 5 ans de garantie**  
Voir condition d'utilisation  
**Até 5 anos de garantia**  
Ver condições de uso



⚡ 230V ac

Hz 50-60Hz

□ CII

☉ 1 Canal/ 2 Vías

⊙ IP44 PLUG

⊙ IP66

∠ 120°

🌡 -25°C~+60 °C

📊 10,2kg (N.W.)

🔌 INC. (x2)

🌀 Rollo 50m

**N/** ideal para instalaciones fijas de exterior  
**E/** ideal for outside installations  
**F/** ideal pour services a l'exterieur fixes  
**P/** deal para instalações exteriores fixa

445603		
445610		

	50cm
∅	13,5x25mm
	120
W%	5W
W	500W
	Max. 50m
🌀	Rollo 50m

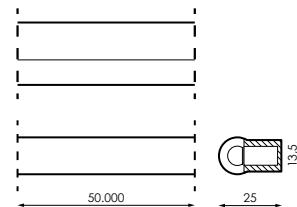

## Aviso/Warning/Avertissement/Aviso

**N/** Cada rollo se sirve con dos cables de alimentación y tapa final. Regulable con TRIAC que realice el corte a principio y fin de fase indistintamente.

**E/** Each roll is served with two power cords and end cover. Adjustable with TRIAC that performs the cut at the beginning and end of the phase interchangeably.

**F/** Chaque rouleau est servi avec deux cordons d'alimentation et couvercle. Réglable avec TRIAC qui effectue la coupe au début et à la fin de la phase de manière interchangeable.

**P/** Cada rolo é servido com dois cabos de alimentação e tampa final. Ajustável com TRIAC que executa o corte no início e no final da fase de maneira intercambiável.

## Accesorios (NO Incluidos) / Accessoires (NOT Included) / Accessories (NON Inclus) / Acessórios (NÃO Incluso)

+ INFO PAG. 292

445627
Cable alimentación Blanco
445641
Empalme L









445634
Empalme simple
445665
Canaleta 1m

445658
Tapa final
445689
Pegamento

445672
Clip sujeción

# flexiLIGHT Led



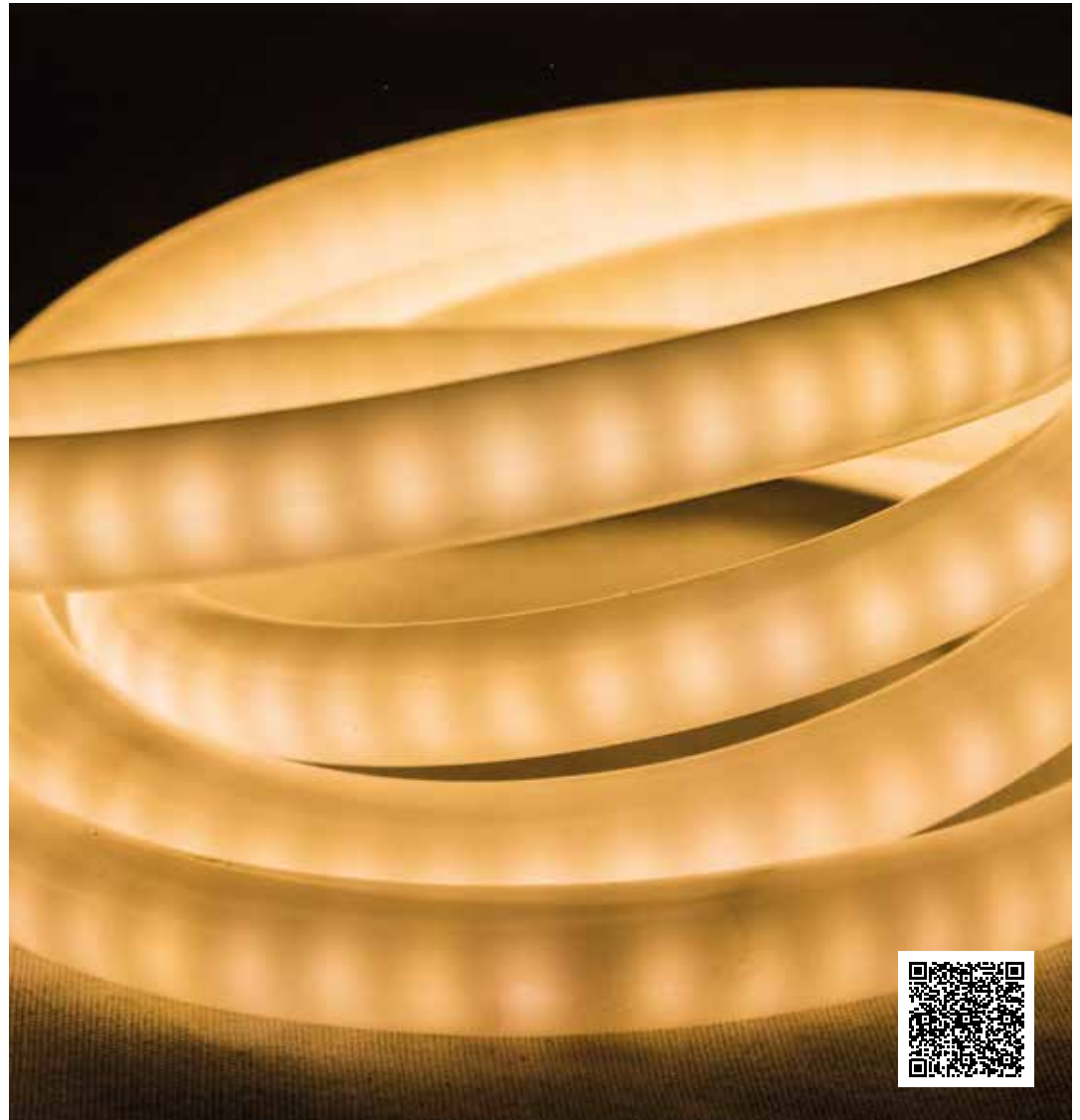

Neon 360°



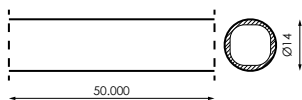



	230V ac
<b>Hz</b>	50-60Hz
	CII
	1 Canal/ 2 Vías
	IP44 PLUG
	IP65
	360°
	-20°C~+60 °C
	10kg (N.W.)
	INC.
	Rollo 50m



**N**/ Exterior/Textura Lisa/Tapa final **INCLUIDA**  
**E**/ Outside/Smooth Texture/End cover **INCLUDED**  
**F**/ À L'exterieur/Texture Lisse/Couvercle **INCLUS**  
**P**/ Exterior/Textura Lisa/Tampa final **INCLUÍDA**



	1m
	14mm
	240
$\frac{W}{\%}$	9,5W
<b>W</b>	475W
	Max. 50m
	Rollo 50m

		
546317		
546324		

Accesorios (NO Incluidos) / Accessoires (NOT Included) / Accessories (NON Inclus) / Acessórios (NÃO Incluso)

+ INFO PAG. 292

546393	Cable alimentación Blanco
--------	---------------------------

546409	Empalme simple
--------	----------------

546416	Tapa final
--------	------------

546423	Clip sujección
--------	----------------



# flexiLIGHT Led

## Mini Neon Slim



⚡ 230V ac

Hz 50-60Hz

□ CII

☺ 1 Canal/ 2 Vías

⊙ IP44 PLUG

⊙ IP65

∠ 360°

🌡 -20°C~+60 °C

📊 10,2kg (N.W.)

🔌 INC.

📦 Rollo 50m

Ñ/ Exterior/Textura Lisa/Tapa final **INCLUIDA**  
 E/ Outside/Smooth Texture/End cover **INCLUDED**  
 F/ A L'exterieur/Texture Lisse/Couvercle **INCLUS**  
 P/ Exterior/Textura Lisa/Tampa final **INCLUIDA**



546355		
546362		

	1m
∅	15x14mm
	120
W/⊕	9W
W	450W
	Max. 50m
📦	Rollo 50m

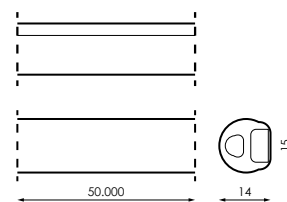

ESQUEMA DE DOBLADO

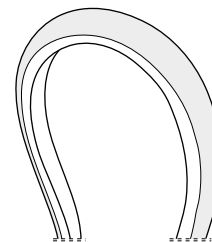

Accesorios (NO Incluidos) / Accessoires (NOT Included) / Accessories (NON Inclus)/ Acessórios (NÃO Incluso)

+ INFO PAG. 292

546478  
Cable alimentación Blanco

546485  
Empalme simple

546492  
Tapa final

546508  
Clip sujección

	230V ac
<b>Hz</b>	50-60Hz
	CII
	1 Canal/ 2 Vías
	IP44 PLUG
	IP65
	360°
	-20°C~+60 °C
	9,4kg (N.W.)
	INC.
	Rollo 50m

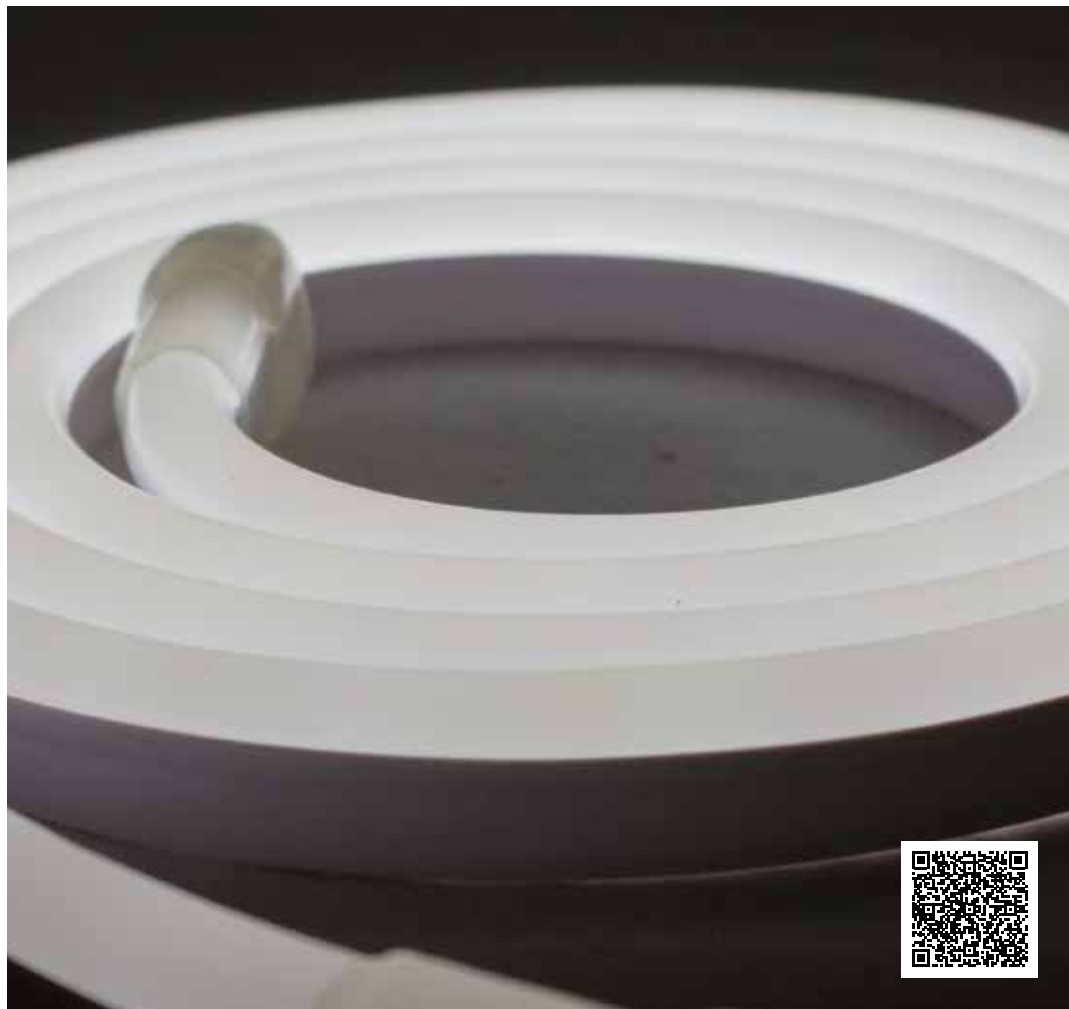

**N/** Exterior/Textura Lisa/Tapa final **INCLUIDA**  
**E/** Outside/Smooth Texture/End cover **INCLUDED**  
**F/** À L'exterieur/Texture Lisse/Couvercle **INCLUS**  
**P/** Exterior/Textura Lisa/Tampa final **INCLUÍDA**

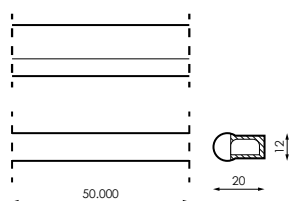

ESQUEMA DE DOBLADO



	1m			
	12x20mm	546331		
	120	546348		
	9W			
<b>W</b>	450W			
	Max. 50m			
	Rollo 50m			

Accesorios (NO Incluidos) / Accessoires (NOT Included) / Accessories (NON Inclus) / Acessórios (NÃO Incluso)

+ INFO PAG. 292

546430	Cable alimentación Blanco
--------	---------------------------

546447	Empalme simple
--------	----------------

546454	Tapa final
--------	------------

546461	Clip sujeción
--------	---------------

# flexiLIGHT Led

## Double Neon

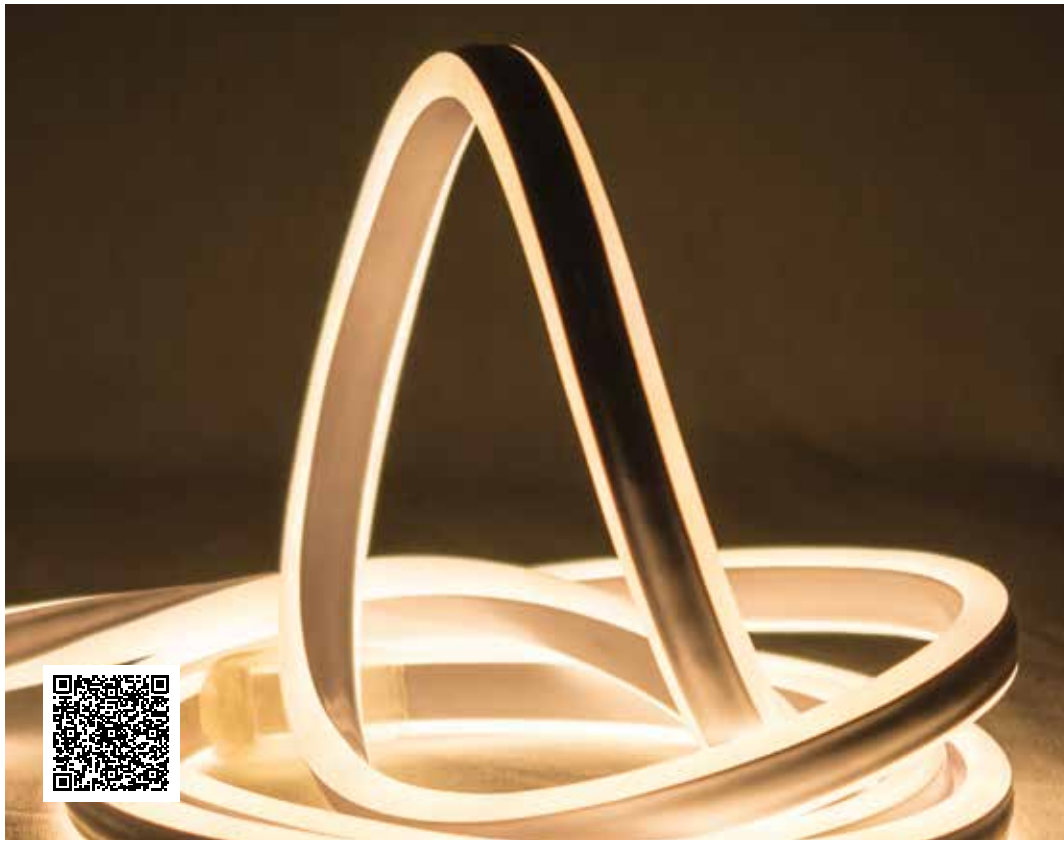

⚡ 230V ac

Hz 50-60Hz

□ CII

⊙ 1 Canal/ 2 Vías

⊙ IP44 PLUG

⊙ IP65

△ 360°

🌡️ -20°C~+60 °C

📊 8kg (N.W.)

🔌 INC.

🌀 Rollo 50m

Ñ/ Exterior/Textura Lisa/Tapa final **INCLUIDA**  
 E/ Outside/Smooth Texture/End cover **INCLUDED**  
 F/ A L'extérieur/Texture Lisse/Couvercle **INCLUS**  
 P/ Exterior/Textura Lisa/Tampa final **INCLUIDA**

546379		
546386		
481588		
481571		
481564		
481595		

	1m
∅	9x16mm
	120
W%	9W
W	450W
	Max. 50m
🌀	Rollo 50m

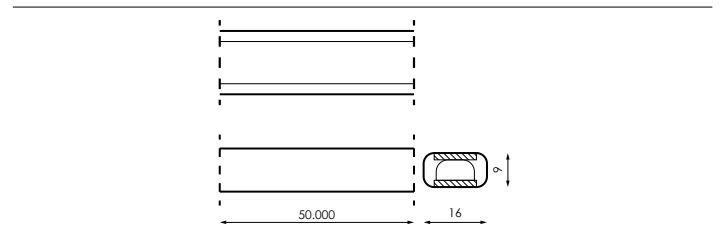

ESQUEMA DE DOBLADO

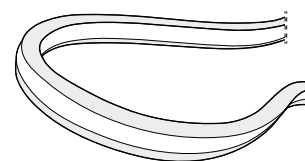

### Accesorios (NO Incluidos) / Accessoires (NOT Included) / Accessories (NON Inclus)/ Acessórios (NÃO Incluso)

+ INFO PAG. 292

546515	Cable alimentación Blanco
518635	Adaptador Smart Link a Flexilight Double Neon
523622	Extensión 50cm blanco

546522	Empalme simple
523615	Adaptador Flexilight Double Neon a Smart Link
566377	Extensión 1m Blanco

546539	Tapa final
518611	Conector macho

546546	Clip sujección
523639	Empalme sencillo



# flexiLIGHT Led

## Double Neon 24V

N

NEW



	24V
<b>Hz</b>	50-60Hz
	CIII
	1 Canal/ 2 Vías
	IP65
	360°
	-20°C~+60 °C
	8kg (N.W.)
	NO INC.
	NO INC.
	Rollo 30m

Ñ/ Exterior/Textura Lisa/Tapa final **INCLUIDA**  
 E/ Outside/Smooth Texture/End cover **INCLUDED**  
 F/ À L'extérieur/Texture Lisse/Couvercle **INCLUS**  
 P/ Exterior/Textura Lisa/Tampa final **INCLUÍDA**

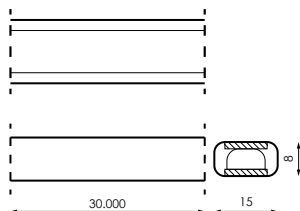

ESQUEMA DE DOBLADO

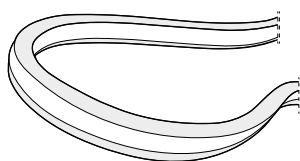

	50cm
	8x15mm
	120
	4,5W
<b>W</b>	270W
	Max. 30m
	Rollo 30m

599856		
599863		

### Accesorios (NO Incluidos) / Accessoires (NOT Included) / Accessories (NON Inclus)/ Acessórios (NÃO Incluso)

+ INFO PAG. 292

488457	Fuente alimentación 60W 24V
<b>N 600934</b>	Empalme
<b>N 601511</b>	Conector macho

488464	Fuente alimentación 100W 24V
<b>N 600927</b>	Tapa final

481687	Fuente alimentación 150W 24V
<b>N 599870</b>	Adaptador Flexilight Double Neon a fuente 24V

481694	Fuente alimentación 200W 24V
<b>N 600910</b>	Adaptador Flexilight Double Neon a 24V

# flexiLIGHT Led

Maxibrillo



	230V ac
<b>Hz</b>	50-60Hz
	CII
	1 Canal/ 2 Vías
	IP44 PLUG
	IP65
	120°
	-20°C~+60 °C
	8,2kg (N.W.)
	INC.
	Rollo 50m

**N**/ Exterior/Textura Lisa/**Tapa final INCLUIDA**  
**E**/ Outside/Smooth Texture/**End cover INCLUDED**  
**F**/ A L'extérieur/Texture Lisse/**Couvercle INCLUS**  
**P**/ Exterior/Textura Lisa/**Tampa final INCLUIDA**

				1m
588171*				12x6mm
576031*				60
588959				*9,5W 5W
576048			<b>W</b>	*475W 250W
576055				Max. 50m
576062				Rollo 50m

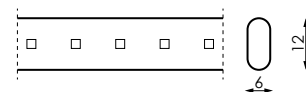

Accesorios (NO Incluidos) / Accessoires (NOT Included) / Accessories (NON Inclus)/ Acessórios (NÃO Incluso)

+ INFO PAG. 292

210713 \* / 576086

Cable alimentación Blanco

576116

Empalme estanco

210744 \* / 576109

Empalme simple

383929 / 576093

Conector macho

210737 \* / 576123

Tapa final

210751

Conector L

210768 \* / 442749

Clip sujeción

\*Hasta fin de existencias/\* Until end of stock/\* Jusqu'à épuisement des stocks/\* Enquanto os estoques durarem

# flexiLIGHT Led

## Brite

**N**  
NEW



⚡ 230V ac

Hz 50-60Hz

☐ CII

☺ 1 Canal/ 2 Vías

⊙ IP44 PLUG

⊙ IP65

∠ 120°

🌡 -25°C~+60 °C

📊 8,2kg (N.W.)

🔌 INC.

🌀 Rollo 50m

Ñ/ Exterior/Textura Lisa/Tapa final **INCLUIDA**  
E/ Outside/Smooth Texture/End cover **INCLUDED**  
F/ A L'exterieur/Texture Lisse/ Couverture **INCLUS**  
P/ Exterior/Textura Lisa/Tampa final **INCLUÍDA**

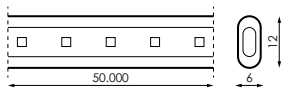
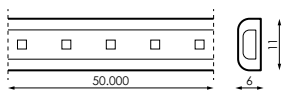

✂ 1m

∅ 11x6mm  
\*12x6mm

☀ 60

W/% 5,5W  
\*5W

W 275W  
\*250W

🔌 Max. 100m

🌀 Rollo 50m



442671



442695 \*



563345\*



563321\*



**N** 588966\*



Accesorios (NO Incluidos) / Accessoires (NOT Included) / Accessories (NON Inclus) / Acessórios (NÃO Incluso)

+ INFO PAG. 292

442701  
Cable alimentación Blanco

442763

Conector L

442718

Conector macho

442794

Tapa final

442770

Conector X

442756

Canaleta 1m

442725

Empalme

442800

Adaptador Smart Link-Flexilight Brite

442787

Extensión 0,5m

442732

Empalme estanco

442817

Adaptador Flexilight Brite-Smart Link

442749

Clip sujeción

\*Hasta fin de existencias/\* Until end of stock/\* Jusqu'à épuisement des stocks/\* Enquanto os estoques durarem



# flexiLIGHT

## Instant Liso

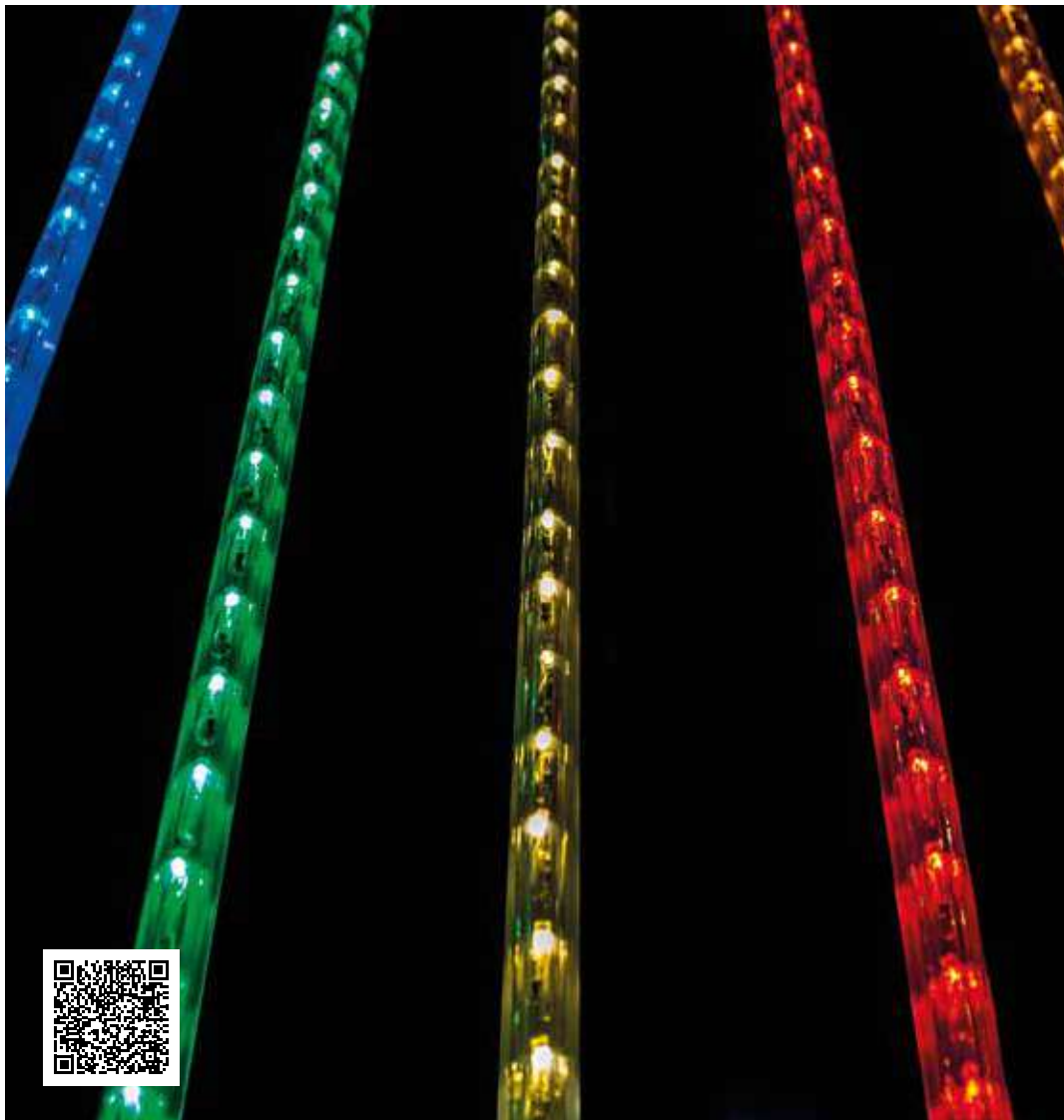

⚡ 230V ac

Hz 50-60Hz

□ CII

☉ 1 Canal/ 2 Vías

⊙ IP44 PLUG

⊙ IP65

∠ 120°

🌡 -20°C~+60 °C

🔌 INC.

🌀 Rollo 50m

**N**/ Exterior/Textura Lisa/Bombilla fusible  
**E**/ Outside/Smooth Texture/Bulb fuse  
**F**/ À L'exterieur/Texture Lisse/Ampoule fusible  
**P**/ Exterior/Textura Lisa/Fusível de bulbo



002684		
002691		
002714		
002721		
002707		
002738		

	1m
∅	13mm
	36
W/⊗	16,56W
W	828W
	Max. 100m
☉	Rollo 50m

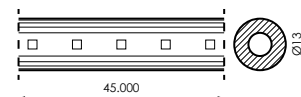

Accesorios (NO Incluidos) / Accessoires (NOT Included) / Accessories (NON Inclus)/ Acessórios (NÃO Incluso)

+ INFO PAG. 292

096744

Cable alimentación Negro

972222

Cable alimentación Blanco sin shucko

972239

Cable alimentación Negro sin shucko

# flexiLIGHT Led

Ø11mm

⚡	230V ac
Hz	50-60Hz
☐	CII
👁️	1 Canal/ 2 Vías
🌧️	IP44 PLUG
	IP65
⚡	360°
🌡️	-25°C~+60 °C
📊	6kg (N.W.)
🔌	INC.
📦	Rollo 45m



CC. Ribera del Xuquer  
Valencia



Ñ/ Exterior/Textura Lisa/Tapa final **INCLUIDA**  
E/ Outside/Smooth Texture/End cover **INCLUDED**  
F/ À L'exterieur/Texture Lisse/Couvercle **INCLUS**  
P/ Exterior/Textura Lisa/Tampa final **INCLUÍDA**

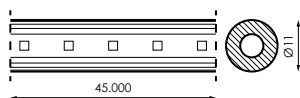

✂️	1m		💡	🔌
∅	11mm	953375	LED	PVC
💡	36	191937	LED	PVC
W/⊕	3W	953382	LED	PVC
W	135W	953399	LED	PVC
🔌	Max. 90m	953450	LED	PVC
📦	Rollo 45m	953467	LED	PVC

Accesorios (NO Incluidos) / Accessoires (NOT Included) / Accessories (NON Inclus) / Acessórios (NÃO Incluso)

+ INFO PAG. 292

953474

Cable alimentación Negro

391542

Cable alimentación Blanco

# Accesorios (NO Incluidos)

Accessoires (NOT Included)

Accessories (NON Inclus)

Acessórios (NÃO Incluso)

		flexiLIGHT 24V	flexiLIGHT 24V Flashing	flexiLIGHT Bomb. Horizontal	flexiLIGHT Flashing	flexiLIGHT Bomb. Vertical	flexiLIGHT Dual	flexiLIGHT Avant IP67	flexiLIGHT Neon	flexiLIGHT Neon 360°	flexiLIGHT Mini Neon Slim	flexiLIGHT Mini Neon	flexiLIGHT Double Neon	flexiLIGHT Double Neon 24V	flexiLIGHT Maxibrillo	flexiLIGHT Brite	flexiLIGHT Instant	flexiLIGHT Ø11mm
	006590																	•
	096744																•	
	150330			•	•	•												
	210713														•			
	391542																	•
	442701															•		
	445627								•									
	481687	•	•											•				
	481694	•	•											•				
	487184							•										
	487191							•										
	488440	•	•															
	488457	•	•											•				
	488464	•	•											•				
	546393								•									
	546430										•							
	546478										•							
	546515											•						
	576086														•			
	952828			•	•	•												
	953474																	•
	972222																•	
	972239																•	
	391559						•											
	971072						•											
	006200	•	•	•	•	•	•										•	
	210768														•			
	442749														•	•		
	442756															•		
	445665							•										
	445672							•										
	446761	•	•	•	•	•	•										•	
	546423								•									
	546461										•							
	546508										•							
	546546											•						
	002776	•	•	•	•	•	•										•	
	006408	•	•	•	•	•	•										•	
	006606																	•
	006941	•	•	•	•	•	•										•	
	010795																	•



		flexiLIGHT 24V	flexiLIGHT 24V Flashing	flexiLIGHT Bomb. Horizontal	flexiLIGHT Flashing	flexiLIGHT Bomb. Vertical	flexiLIGHT Dual	flexiLIGHT Avant IP67	flexiLIGHT Neon	flexiLIGHT Neon 360°	flexiLIGHT Mini Neon Slim	flexiLIGHT Mini Neon	flexiLIGHT Double Neon	flexiLIGHT Double Neon 24V	flexiLIGHT Maxibrillo	flexiLIGHT Brite	flexiLIGHT Instant	flexiLIGHT Ø11mm
	010818			•	•	•	•										•	
	064354	•	•	•	•	•	•										•	
	064729	•	•	•	•	•	•										•	
	068017																	•
	068048																	•
	084727	•	•	•	•	•	•										•	
	097109	•	•	•	•	•	•	•									•	•
	194556	•	•				•											
	210737														•			
	210744														•			
	210751														•			
	236010	•	•	•	•	•	•										•	
	383929														•			
	388405	•	•	•	•	•	•										•	
	388559																	•
	398121																	•
	442718															•		
	442725															•		
	442732															•		
	442763															•		
	442770															•		
	442787															•		
	442800															•		
	442817															•		
	445634							•										
	445641							•										
	445689							•										
	518611												•					
	518635												•					
	523615												•					
	523622												•					
	523639																	
	546409							•										
	546447										•							
	546485									•								
	546522											•						
	566377																	
	576093														•			
	576109														•			
	576116														•			
	599870													•				
	600910													•				
	600934													•				
	601511													•				
	971195							•										
	971201							•										
	971218							•										
	001717																	•
	011853			•	•	•											•	
	442794															•		

	flexiLIGHT 24V	flexiLIGHT 24V Flashing	flexiLIGHT Bomb. Horizontal	flexiLIGHT Flashing	flexiLIGHT Bomb. Vertical	flexiLIGHT Dual	flexiLIGHT Avant IP67	flexiLIGHT Neon	flexiLIGHT Neon 360°	flexiLIGHT Mini Neon Slim	flexiLIGHT Mini Neon	flexiLIGHT Double Neon	flexiLIGHT Double Neon 24V	flexiLIGHT Maxibrillo	flexiLIGHT Brite	flexiLIGHT Instant	flexiLIGHT Ø11mm
445658								•									
546416									•								
546454											•						
546492										•							
546539												•					
576123														•			
600927													•				

### FUENTE ALIMENTACIÓN 24V

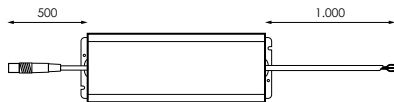

488440	170-240V	24V	30W	IP66/ IP44 Plug	202 x 34 x 36mm	1 salida
488457	170-240V	24V	60W	IP66/ IP44 Plug	197 x 45 x 32mm	1 salida
488464	170-240V	24V	100W	IP66/ IP44 Plug	248 x 45 x 32mm	1 salida
481687	100-240V	24V	150W	IP66/ IP44 Plug	230 x 63 x 39mm	1 salida
481694	100-240V	24V	200W	IP66/ IP44 Plug	260 x 73 x 45mm	2 salidas

### ADAPTADOR 24V/DUAL

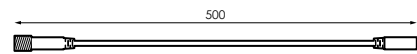

A

194556

Adaptador del rectificador a Flexilight Led  
Adapter of rectifier to Flexilight Led  
Adaptateur redresseur à Flexilight Led  
Adaptador de retificador para Flexilight Led

### CABLE ALIMENTACIÓN Ø13mm

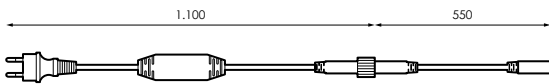

952828	230Vac	Max. 480W	CII	IP44 Plug IP65 Conector
150330	230Vac	Max. 480W	CII	IP44 Plug IP65 Conector

### CABLE ALIMENTACIÓN AVANT Ø13mm

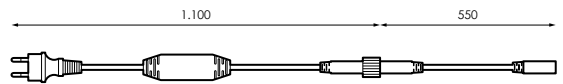

487184	230Vac	Max. 480W	CII	IP44 Plug IP67 Conector
487191	230Vac	Max. 480W	CII	IP44 Plug IP67 Conector

### CABLE ALIMENTACIÓN Ø11mm

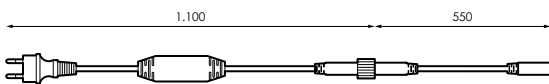

953474	230Vac	Max. 480W	CII	IP44 Plug IP65 Conector
391542	230Vac	Max. 480W	CII	IP44 Plug IP65 Conector

### CABLE ALIMENTACIÓN

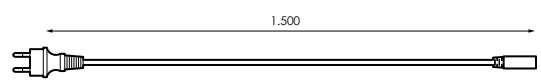

096744	FLEXILIGHT 13mm
006590	FLEXILIGHT 11mm Horizontal

### CABLE ALIMENTACIÓN Ø13mm

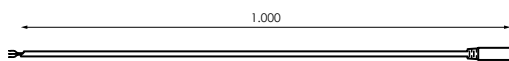

972239	230V	CII
972222	230V	CII

### CONECTOR Y

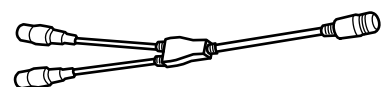

084727	Flexilight 13mm. PVC. 1 Canal
006606	Flexilight 11mm. PVC. 1 Canal

### CONECTOR X

PVC/1 canal

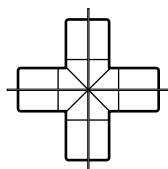

010795 Flexilight 11mm

068048 Flexilight 11mm

### EXTENSIÓN

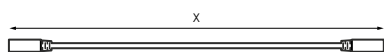

388405 Empalme simple 0,5m 13mm 1canal  
Simple joint 0,5m 1cannal 13mm  
Articulation simple 0,5m 1canal 13mm  
Junção simples 0,5m 13mm 1canal

236010 Empalme simple 1m 13mm 1canal  
Simple joint 1m 1cannal 13mm  
Articulation simple 1m 1canal 13mm  
Junção simples 1m 13mm 1canal

006941 Empalme simple 3m 13mm 1canal  
Simple joint 3m 1cannal 13mm  
Articulation simple 3m 1canal 13mm  
Junção simples 3m 13mm 1canal

Termoretractil y conector macho **NO INCLUIDOS**  
Heat-shrinkable and male connector **NOT INCLUDED**  
Thermorétractable et connecteur mâle **NON INCLUS**  
Tubo de contração térmica e conector macho **NÃO INCLUIDO**

### EMPALME ESTANCO

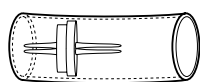

010818 Flexilight 13mm

068017 Flexilight 11mm

### EMPALME SENCILLO

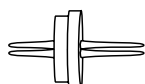

002776 Flexilight 13mm

398121 Flexilight 11mm

### CONECTOR T

PVC/1 canal

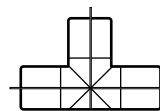

064729 Flexilight 13mm

006408 Flexilight 13mm

### TERMORRETRACTIL

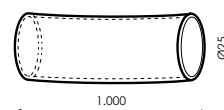

097109 Ø19,1mm para Flexilight. Recubrimiento interior de resina termoplástica. Rollo 1m.  
Ø19,1mm for Flexilight. Thermoplastic resin inner lining. Roll 1m.  
Ø19,1mm pour Flexilight. Doublure intérieure en résine thermoplastique. Rouler 1m.  
Ø19,1mm para Flexilight. Revestimento interno em resina termoplástica. Roll 1m.

972451 Pistola aire caliente profesional 2000W  
Hot air gun professional 2000W  
Pistolet à air chaud 2000W professionnel  
Soprador de ar quente 2000W profissional

### CONECTOR MACHO

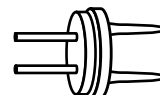

388559 Flexilight 11mm

064354 Flexilight 13mm

### TAPA FINAL

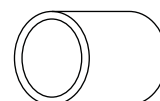

011853 Flexilight 13mm

001717 Flexilight 11mm



CLIP SUJECCIÓN

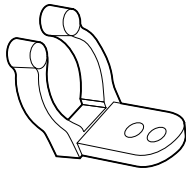

446761

Flexilight 13mm

CANALETA Ø13mm



006200



2m



Transparente

CONTROLADOR DUAL

2A

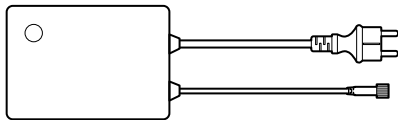

391559



230V



Max. 240W



8 funciones efecto memoria  
8 fonctions memory effect  
8 fonctions effet mémoire  
8 funções efeito de memória

CONTROLADOR DUAL

6A

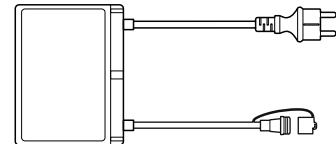

971072



230V



Max. 1.200W



\*Max. 240m (máx. 90m por salida)/ 4 funciones  
\*Max. 240m (max. 90m per output)/ 4 fonctions  
\*Max. 240m (max. 90m par sortie)/ 4 fonctions  
\*Max. 240m (max. 90m por saída)/ 4 funções

CONECTOR DUAL

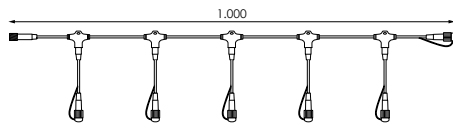

971201

5 Portalámparas (1m)  
5 Lampholders (1m)  
5 Douilles (1m)  
5 Portalâmpadas (1m)

CONECTOR DUAL

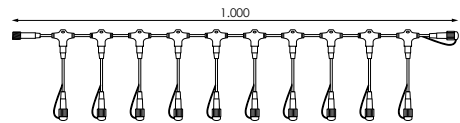

971195

10 Portalámparas (1m)  
10 Lampholders (1m)  
10 Douilles (1m)  
10 Portalâmpadas (1m)

EXTENSION-CONECTOR DUAL

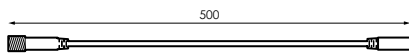

194549

Extensión conector dual a Flexilight Led dual  
Extension dual connector to Flexilight Led dual  
Extension connecteur double à Flexilight Led double  
Extensão conector duplo para Flexilight Led duplo

CONECTOR DUAL

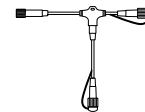

971218

Conector T  
Connector T  
Connecteur en T  
Conector em T

CABLE ALIMENTACIÓN NEON 360°

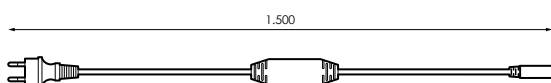

546393



230Vac/dc



IP44 Plug  
IP65 Conector



Empalme Neon 360°

EMPALME NEON 360°

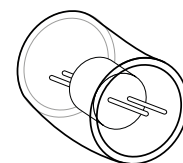

546409



Blanco

CLIP SUJECCIÓN NEON 360°

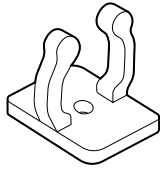

546423



Transparente

TAPA FINAL NEON 360°

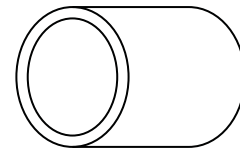

546416



Transparente

CABLE ALIMENTACIÓN MINI NEON SLIM

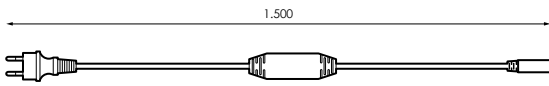

546478



230Vac/dc



IP44 Plug  
IP65 Conector

EMPALME MINI NEON SLIM

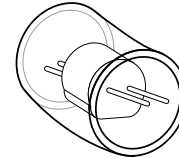

546485



Blanco

CLIP SUJECCIÓN MINI NEON SLIM

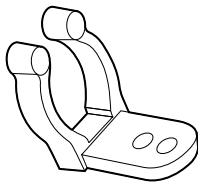

546508



Transparente

TAPA FINAL MINI NEON SLIM

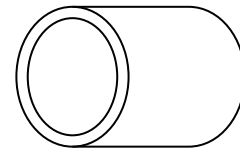

546492



Transparente

CABLE ALIMENTACIÓN MINI NEON

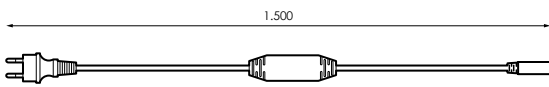

546430



230Vac/dc



IP44 Plug  
IP54 Conector

EMPALME MINI NEON

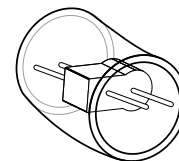

546447



Blanco

CLIP SUJECCIÓN MINI NEON

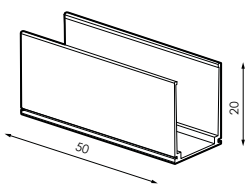

546461



Aluminio

TAPA FINAL MINI NEON

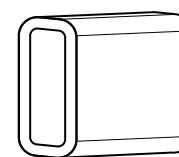

546454



Transparente

CABLE ALIMENTACIÓN DOUBLE NEON

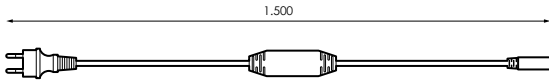

546515



230Vac/dc



IP44 Plug  
IP65 Conector

EMPALME DOUBLE NEON

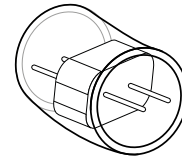

546522



Blanco

CLIP SUJECCIÓN DOUBLE NEON

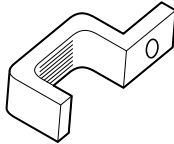

546546



Transparente

TAPA FINAL DOUBLE NEON

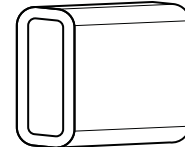

546539



Transparente

ADAPTADOR SMART LINK-FLEXILIGHT DOUBLE NEON

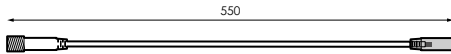

518635



Blanco

ADAPTADOR FLEXILIGHT DOUBLE NEON-SMART LINK

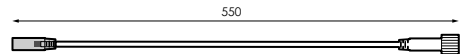

523615



Blanco

EMALME SENCILLO DOUBLE NEON

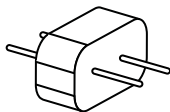

523639



Transparente

CONECTOR MACHO DOUBLE NEON

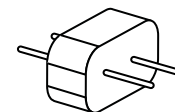

518611



Transparente

EXTENSIÓN DOUBLE NEON

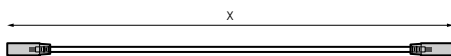

523622

0,5m



Blanco

566377

1m



Blanco

ADAPTADOR FUENTE 24V - FLEXILIGHT DOUBLE NEON 24V

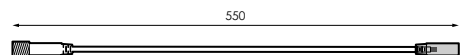

599870



Blanco



TAPA FINAL DOUBLE NEON 24V

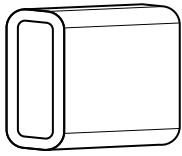

600927



T

Transparente

EMPALME DOUBLE NEON 24V

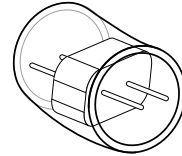

600934



BI

Blanco

CONECTOR MACHO DOUBLE NEON 24V

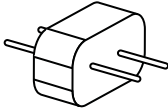

601511



T

Transparente

ADAPTADOR FLEXILIGHT DOUBLE NEON 24V - 24V

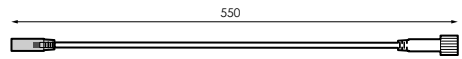

A



600910



BI

Blanco

CABLE ALIMENTACIÓN NEON

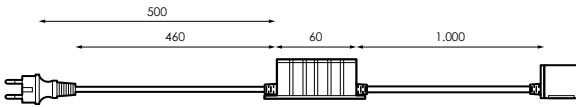

445627



230Vac/dc



Max. 600W

W



IP44 Plug  
IP66 Conector

EMPALME L NEON

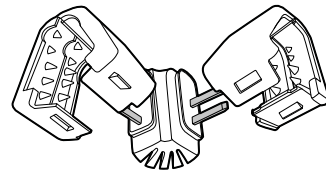

445641



T

Transparente

EMPALME SENCILLO NEON

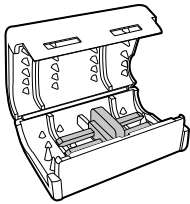

445634



T

Transparente

TAPA FINAL NEON

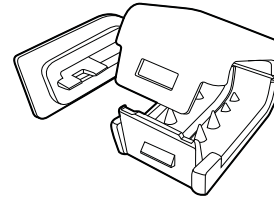

445658



T

Transparente

CLIP SUJECCIÓN NEON

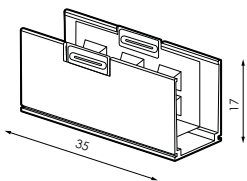

445672



A

Aluminio

CANAleta NEON

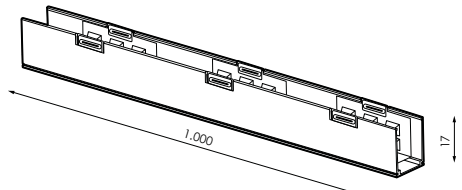

445665



A

Aluminio

PEGAMENTO NEON

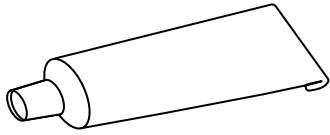

445689

CABLE ALIMENTACIÓN MAXIBRILLO

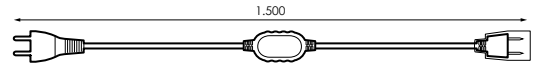

576086



230Vac Max. 480W



IP44 Plug  
IP65 Conector

210713



230Vac

Max. 480W

IP44 Plug  
IP65 Conector

EMPALME ESTANCO MAXIBRILLO

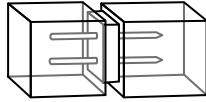

576116



Transparente

CLIP SUJECCIÓN MAXIBRILLO

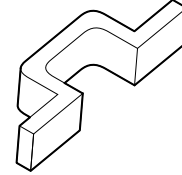

210768



Transparente

EMPALME SIMPLE MAXIBRILLO

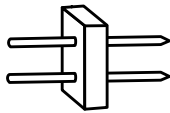

576109



Transparente

210744



Transparente

CONECTOR L MAXIBRILLO

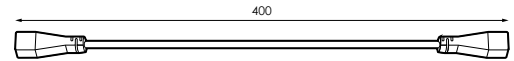

210751



Blanco

CONECTOR MACHO MAXIBRILLO

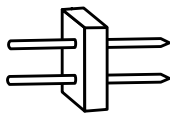

576093



Transparente

383929



Transparente

TAPA FINAL MAXIBRILLO

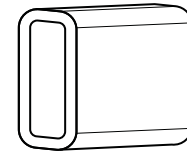

576123



Transparente

210737



Transparente

CABLE ALIMENTACIÓN BRITE

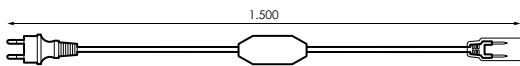

442701



230Vac



Max. 480W



IP44 Plug  
IP66 Conector

EXTENSIÓN BRITE

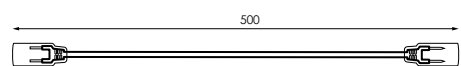

442787



Blanco

ADAPTADOR FLEXILIGHT BRITE-SMART LINK

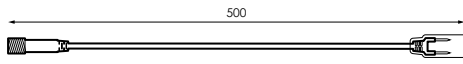

A



442817



BI

Blanco

ADAPTADOR SMART LINK-FLEXILIGHT BRITE

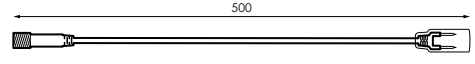

A



442800



BI

Blanco

CONECTOR L BRITE

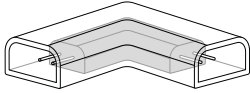

442763



T

Transparente

CONECTOR X BRITE

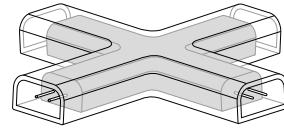

442770



T

Transparente

EMPALME BRITE

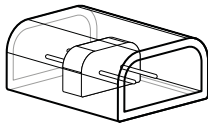

442732



T

Transparente

EMPALME SENCILLO BRITE

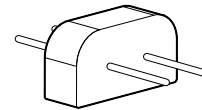

442725



T

Transparente

CONECTOR MACHO BRITE

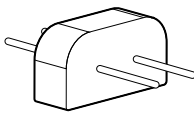

442718



T

Transparente

TAPA FINAL BRITE

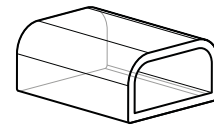

442794



T

Transparente

CLIP SUJECCIÓN BRITE/MAXIBRILLO

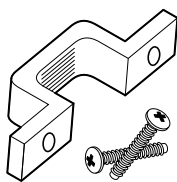

442749



T

Transparente

CANALETA BRITE



442756



1m



T

Transparente







minimalist





# STRING PLUS 100

Exterior



Los Silos

Santa Cruz de Tenerife

⚡ 230V dc

Hz 50-60Hz

□ CII

☺ 1 CANAL

°° IP65

🌡 -20°C~+60 °C

📊 0,9kg (N.W.)

⊗ NO INC.

📦 10ud

Barcode	LED	Light	Color
546690	LED	Warm White	White
546706	LED	Warm White	Green
546713	LED	Warm White	White
546720	LED	Warm White	Green
546737	LED	Warm White	Blue
546744	LED	Warm White	Green
546751	LED	Warm White	Red
546768	LED	Warm White	Yellow
546775	LED	Warm White	White
546782	LED	Warm White	Purple

↔	10m (5m x 2seg)
⏏	5m
💡	100
💡	50
W	8W
W	4W
🔌	100m

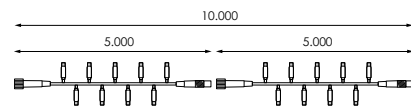

ESQUEMA INSTALACIÓN/  
INSTALLATION SCHEME/  
SCHEMA D'INSTALLATION/  
ESQUEMA DE  
INSTALAÇÃO



+

Producto/Product  
Produit/Produto

Accesorios (NO Incluidos) / Accessoires (NOT Included) / Accessories (NON Inclus) / Acessórios (NÃO Incluso)

+ INFO PAG. 328

995092

Cable alimentación Negro

977722

Cable alimentación Blanco

# STRING **PLUS** 100 Flashing

Exterior

	230V dc
<b>Hz</b>	50-60Hz
	CII
	1 CANAL
	IP65
	-20°C~+60 °C
	0,9kg (N.W.)
	NO INC.
	10ud



SMART  
LINK

Los Silos  
Santa Cruz de Tenerife

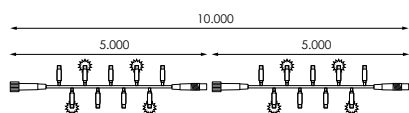

ESQUEMA INSTALACIÓN/  
INSTALLATION SCHEME/  
SCHEMA D'INSTALLATION/  
ESQUEMA DE  
INSTALAÇÃO



Producto/Product  
Produit/Produto

	10m (5m x 2seg)
	5m
	100
	40+10 flashing
<b>W</b>	8W
	4W
	100m

546799		
546805		
546812		
546829		

Accesorios (NO Incluidos) / Accessoires (NOT Included) / Accessories (NON Inclus)/ Acessórios (NÃO Incluso)

+ INFO PAG. 328

995092

Cable alimentación Negro

977722

Cable alimentación Blanco











# SCREENLIGHT 100

Exterior















SMART LINK 

	230V dc
Hz	50-60Hz
	CII
	1 CANAL
	IP65
	-20°C~+60 °C
	1kg (N.W.)
	NO INC.
	10ud

Ciudad de Braga 2020  
by AM Illumination  
Producto Prilux



		
503969		
503976		

	2x1m
	20
	2
	100
	5
W	7,7W
	10sets

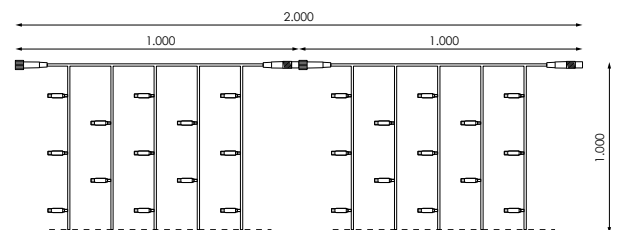

ESQUEMA INSTALACIÓN/  
INSTALLATION SCHEME/  
SCHEMA D'INSTALLATION/  
ESQUEMA DE  
INSTALAÇÃO



+

Producto/Product  
Produit/Produto

Accesorios (NO Incluidos) / Accessoires (NOT Included) / Accessories (NON Inclus) / Acessórios (NÃO Includo)









+ INFO PAG. 328

995092  
Cable alimentación Negro

977722  
Cable alimentación Blanco

# SCREENLIGHT 150

Exterior

	230V dc
<b>Hz</b>	50-60Hz
	CII
	1 CANAL
	IP65
	-20°C~+60 °C
	1,5kg (N.W.)
	NO INC.
	10ud



SMART LINK 

Rugat  
Valencia





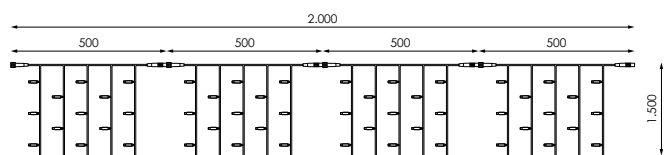









[GRÁFICOS: Unidades en mm/ GRÁFICOS: Units in mm/ GRAPHICS: Units in mm/ GRÁFICOS: Unidades em mm]



ESQUEMA INSTALACIÓN/  
INSTALLATION SCHEME/  
SCHEMA D'INSTALLATION/  
ESQUEMA DE  
INSTALAÇÃO



+ Producto/Product  
Produit/Produto

	2x1,5m			
	20	503990		
	4	504003		
	150			
	7/8			
<b>W</b>	15W			
	10sets			

Accesorios (NO Incluidos) / Accessoires (NOT Included) / Accessories (NON Includo) / Acessórios (NÃO Includo)

+ INFO PAG. 328

995092

Cable alimentación Negro







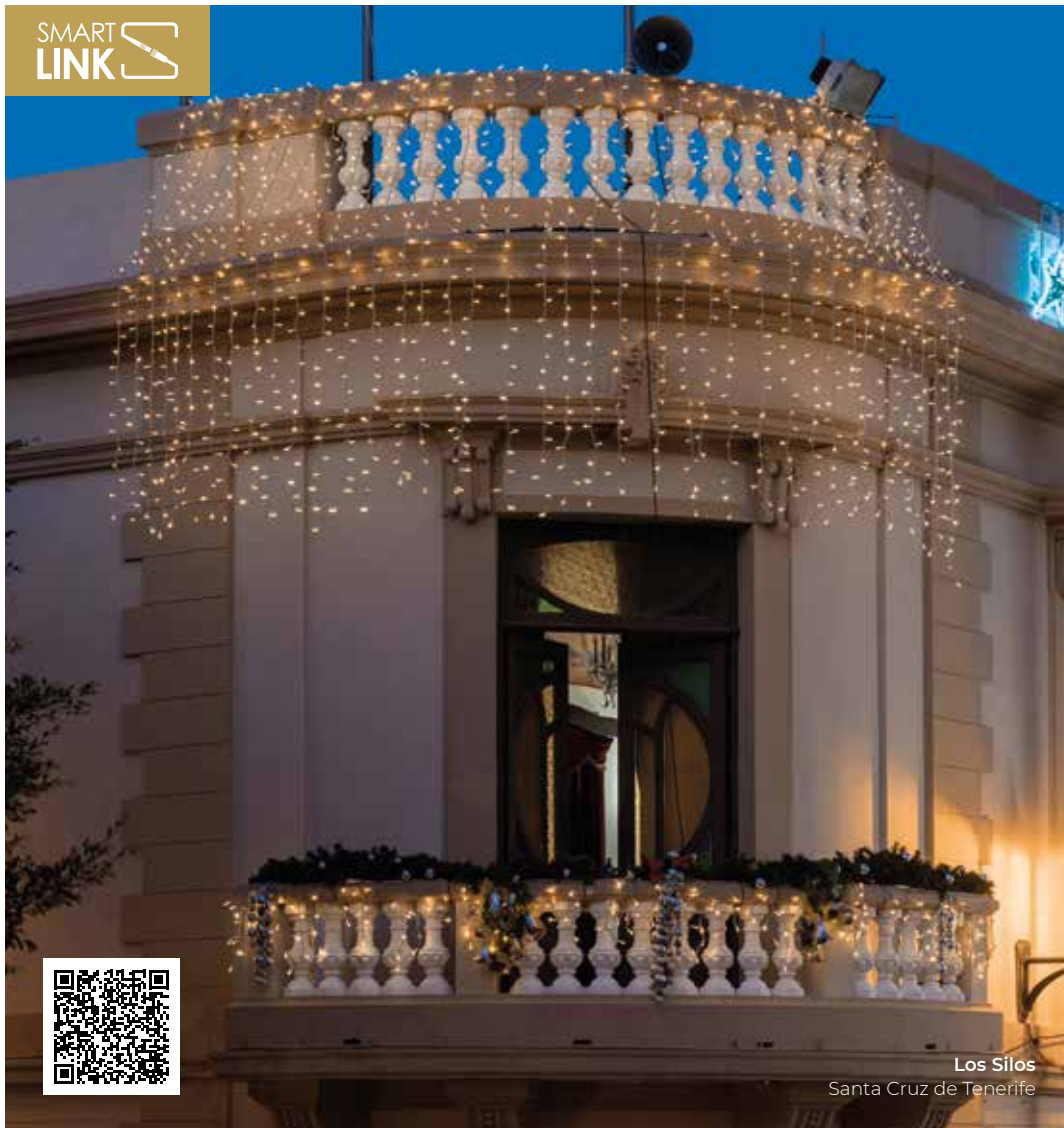

977722

Cable alimentación Blanco

# SCREENLIGHT 300

Exterior















	230V dc
	50-60Hz
	CII
	1 CANAL
	IP65
	-20°C~+60 °C
	3kg (N.W.)
	NO INC.
	10ud



Los Silos

Santa Cruz de Tenerife

				2x3m
504010				20
561471				4
				300
				15
			<b>W</b>	15W
				7sets

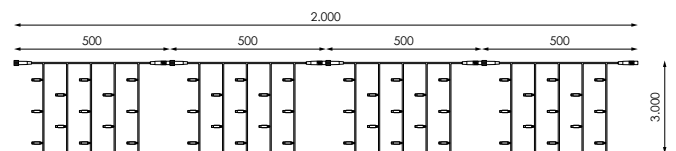

ESQUEMA INSTALACIÓN/  
INSTALLATION SCHEME/  
SCHEMA D'INSTALLATION/  
ESQUEMA DE  
INSTALAÇÃO



+

Producto/Product  
Produit/Produto

Accesorios (NO Incluidos) / Accessoires (NOT Included) / Accessories (NON Inclus) / Acessórios (NÃO Incluso)

+ INFO PAG. 328

995092

Cable alimentación Negro









977722

Cable alimentación Blanco



# SCREENLIGHT 600

Exterior

	230V dc
<b>Hz</b>	50-60Hz
	CII
	1 CANAL
	IP65
	-20°C~+60 °C
	7kg (N.W.)
	NO INC.
	10ud



SMART LINK 

CC Parque Corredor  
Alcala de Henares, Madrid

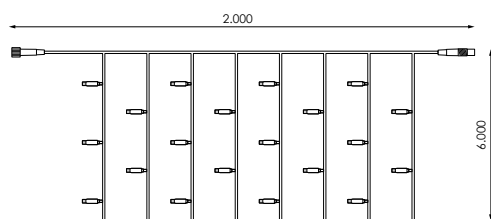

ESQUEMA INSTALACIÓN/  
INSTALLATION SCHEME/  
SCHEMA D'INSTALLATION/  
ESQUEMA DE  
INSTALAÇÃO



Producto/Product  
Produit/Produto



2x6m



20



600



30



35W



3sets



546898



LED







2x6m



20



4



600



30



42,5W



3sets



530347



LED







504133



LED





[GRÁFICOS: Unidades en mm/ GRÁFICOS: Units in mm/ GRAPHIQUES: Units in mm/ GRÁFICOS: Unidades em mm]

ESQUEMA INSTALACIÓN/  
INSTALLATION SCHEME/  
SCHEMA D'INSTALLATION/  
ESQUEMA DE  
INSTALAÇÃO



Producto/Product  
Produit/Produto

Accesorios (NO Incluidos) / Accessoires (NOT Included) / Accessories (NON Includo) / Acessórios (NÃO Includo)

+ INFO PAG. 328

995092

Cable alimentación Negro

977722









Cable alimentación Blanco







# SCREENLIGHT 900







Exterior



CC. Maltería Plaza  
Latacunga, Ecuador

	230V dc
	50-60Hz
	CII
	1 CANAL
	IP65
	-20°C~+60 °C
	9kg (N.W.)
	NO INC.
	Tud

		
504027		
504034		

	2x9m
	20
	4
	900
	45
<b>W</b>	70W
	NO Empalmable

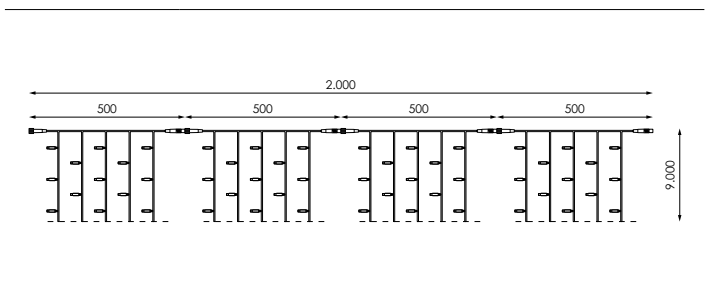

ESQUEMA INSTALACIÓN/  
INSTALLATION SCHEME/  
SCHEMA D'INSTALLATION/  
ESQUEMA DE  
INSTALAÇÃO



+

Producto/Product  
Produit/Produto

Accesorios (NO Incluidos) / Accessoires (NOT Included) / Accessories (NON Inclus) / Acessórios (NÃO Incluso)









+ INFO PAG. 328

995092  
Cable alimentación Negro

977722  
Cable alimentación Blanco

# SCREENLIGHT 150 Flashing

Exterior

	230V dc
<b>Hz</b>	50-60Hz
	CII
	1 CANAL
	IP65
	-20°C~+60 °C
	1,5kg (N.W.)
	NO INC.
	10ud



Cortijo MBI  
Sevilla



[GRÁFICOS: Unidades en mm/ GRÁFICOS: Units in mm/ GRAPHICS: Units in mm/ GRÁFICOS: Unidades em mm]

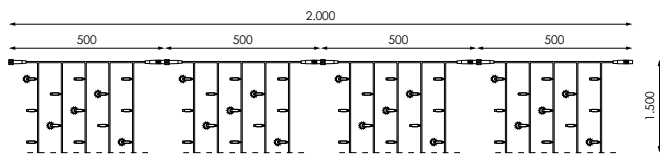













ESQUEMA INSTALACIÓN/  
INSTALLATION SCHEME/  
SCHEMA D'INSTALLATION/  
ESQUEMA DE  
INSTALAÇÃO



+

Producto/Product  
Produit/Produto

	2x1,5m
	20
	4
	150
	5+2 flashing /6+2 flashing
<b>W</b>	15W
	10sets

		
504096		
504102		

Accesorios (NO Incluidos) / Accessoires (NOT Included) / Accessories (NON Inclus) / Acessórios (NÃO Incluso)

+ INFO PAG. 328

995092

Cable alimentación Negro

977722









Cable alimentación Blanco









# SCREENLIGHT 300 Flashing







Exterior



	230V dc
Hz	50-60Hz
	CII
	1 CANAL
	IP65
	-20°C~+60 °C
	3kg (N.W.)
	NO INC.
	10ud

CC. Nervión Plaza  
Sevilla

		
504119		
504126		

	2x3m
	20
	4
	300
	12+3 flashing
W	18,4W
	7sets

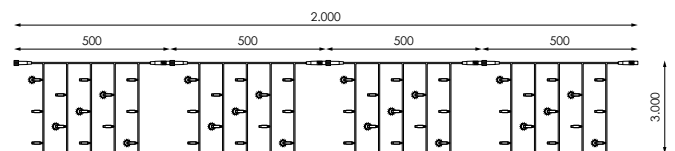

ESQUEMA INSTALACIÓN/  
INSTALLATION SCHEME/  
SCHEMA D'INSTALLATION/  
ESQUEMA DE  
INSTALAÇÃO



+

Producto/Product  
Produit/Produto

Accesorios (NO Incluidos) / Accessoires (NOT Included) / Accessories (NON Inclus) / Acessórios (NÃO Incluso)









+ INFO PAG. 328

995092  
Cable alimentación Negro

977722  
Cable alimentación Blanco

# SCREENLIGHT 600 Flashing

Exterior

	230V dc
<b>Hz</b>	50-60Hz
	CII
	1 CANAL
	IP65
	-20°C~+60 °C
	7kg (N.W.)
	NO INC.
	10ud

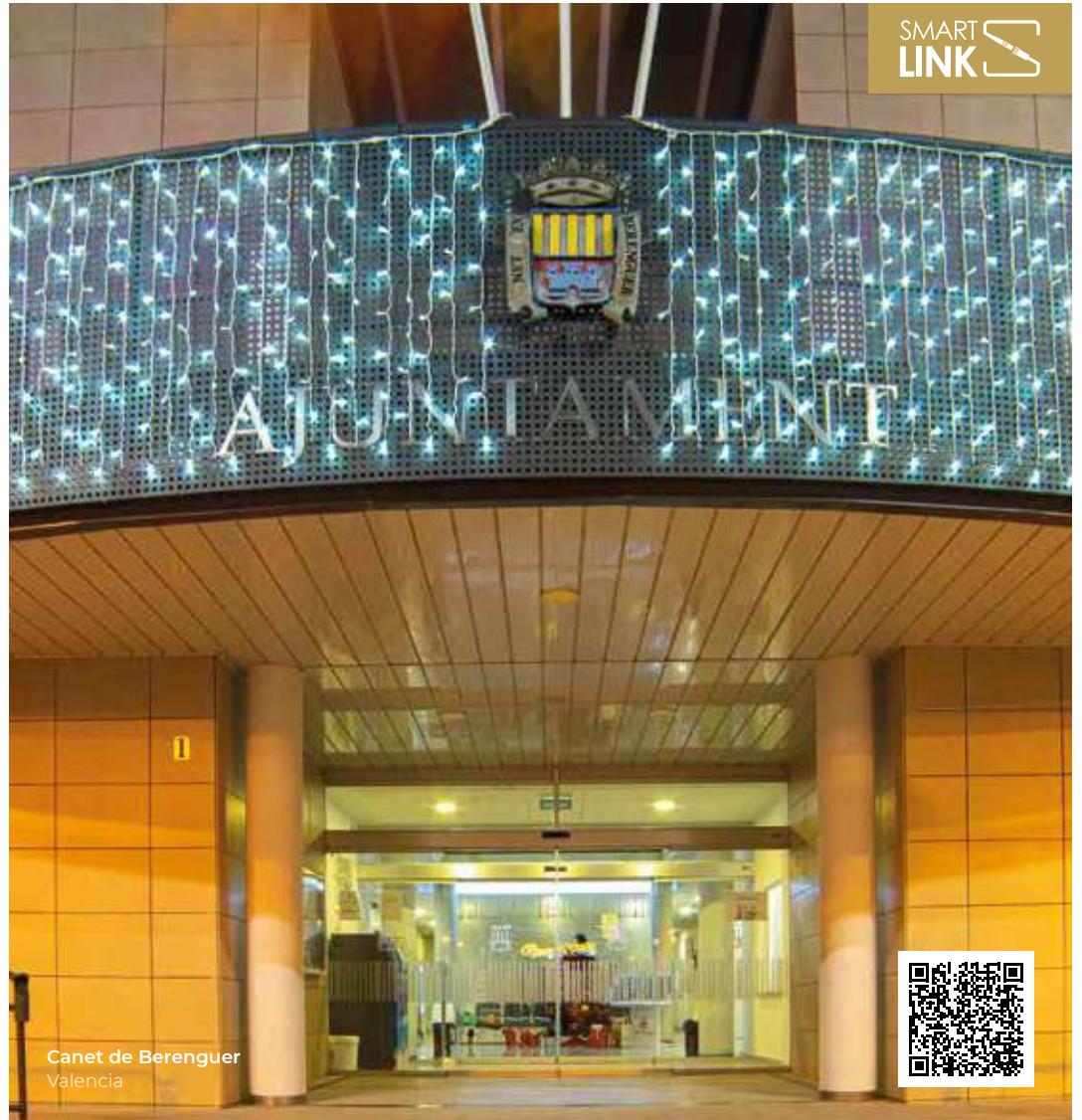

Canet de Berenguer  
Valencia





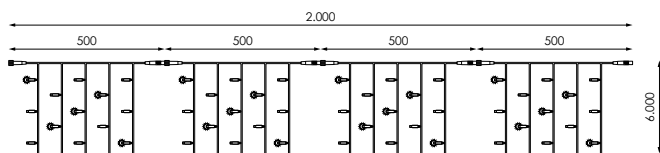









[GRÁFICOS: Unidades en mm/ GRÁFICOS: Units in mm/ GRAPHICS: Units in mm/ GRÁFICOS: Unidades em mm]



ESQUEMA INSTALACIÓN/  
INSTALLATION SCHEME/  
SCHEMA D'INSTALLATION/  
ESQUEMA DE  
INSTALAÇÃO



Producto/Product  
Produit/Produto

	2x6m			
	20	504140		
	4	504157		
	600			
	24+6 flashing			
<b>W</b>	44W			
	3sets			

Accesorios (NO Incluidos) / Accessoires (NOT Included) / Accessories (NON Inclus) / Acessórios (NÃO Incluso)

+ INFO PAG. 328

995092

Cable alimentación Negro

977722

Cable alimentación Blanco



# SCREENLIGHT 900 Flashing

Exterior



SMART LINK 

 230V dc

Hz 50-60Hz

 CII

 1 CANAL

 IP65

 -20°C~+60 °C













 9kg (N.W.)

 NO INC.

 1ud



CC: Quicentro  
Quito, Ecuador

				2x9m
504041				20
504058				4
				900
				36+9 flashing
	<b>W</b>			70W
				NO Empalmable

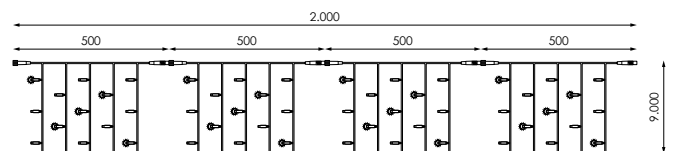

ESQUEMA INSTALACIÓN/  
INSTALLATION SCHEME/  
SCHEMA D'INSTALLATION/  
ESQUEMA DE  
INSTALAÇÃO



+

Producto/Product  
Produit/Produto

Accesorios (NO Incluidos) / Accessoires (NOT Included) / Accessories (NON Inclus) / Acessórios (NÃO Incluso)

+ INFO PAG. 328

995092

Cable alimentación Negro

977722

Cable alimentación Blanco





CC. Luz del Tajo  
Toledo

# ICICLE<sup>®</sup> 102

Exterior



SMART LINK

⚡ 230V dc

Hz 50-60Hz

☐ CII

🎧 1 CANAL

🌡️ IP65

🌡️ -20°C~+60 °C

📊 1,4kg (N.W.)

⊗ NO INC.

📦 10ud



Los Silos  
Santa Cruz de Tenerife

546973		
546980		

	3x1m (1,5m x 2seg)
	2
	102
	51
W	8W
	15sets

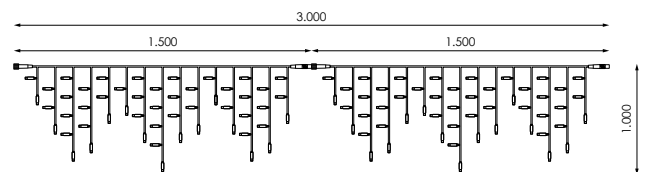

ESQUEMA INSTALACIÓN/  
INSTALLATION SCHEME/  
SCHEMA D'INSTALLATION/  
ESQUEMA DE  
INSTALAÇÃO



+

Producto/Product  
Produit/Produto

Accesorios (NO Incluidos) / Accessoires (NOT Included) / Accessories (NON Inclus) / Acessórios (NÃO Incluso)

+ INFO PAG. 328

995092

Cable alimentación Negro









977722

Cable alimentación Blanco



# ICICLE<sup>®</sup> 102 Flashing

Exterior

	230V dc
<b>Hz</b>	50-60Hz
	CII
	1 CANAL
	IP65
	-20°C~+60 °C
	1,4kg (N.W.)
	NO INC.
	10ud



SMART LINK 

Noa Boutique Hotel  
Santa Cruz, A Coruña



[GRÁFICOS: Unidades en mm/ GRÁFICOS: Units in mm/ GRAPHICS: Units in mm/ GRÁFICOS: Unidades em mm]

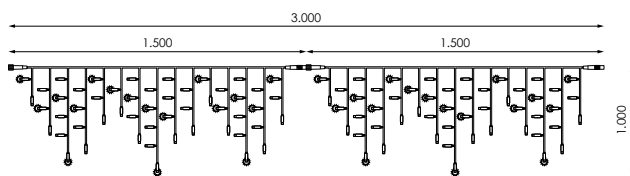













ESQUEMA INSTALACIÓN/  
INSTALLATION SCHEME/  
SCHEMA D'INSTALLATION/  
ESQUEMA DE  
INSTALAÇÃO



+

Producto/Product  
Produit/Produto

	3x1m (1,5m x 2seg)
	2
	102
	42+9 flashing
<b>W</b>	8W
	15sets

		
546997		
547000		

Accesorios (NO Incluidos) / Accessoires (NOT Included) / Accessories (NON Inclus) / Acessórios (NÃO Incluso)

+ INFO PAG. 328

995092

Cable alimentación Negro

977722

Cable alimentación Blanco



# STRING PLUS 100

## Interior



SMART LINK

⚡ 230V dc

Hz 50-60Hz

□ CII

☺ 1 CANAL

⊙ IP20

🌡 -20°C~+60 °C

📊 0,9kg (N.W.)

✗ NO INC.

📦 10ud

CC. ABC Serrano  
Madrid

547017		
502030		

↔	12m (6m x 2seg)
⏏	6m
💡	100
💡	50
W	8W
⏏	4W
🔌	100m

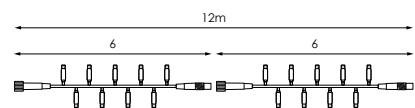

ESQUEMA INSTALACIÓN/  
INSTALLATION SCHEME/  
SCHEMA D'INSTALLATION/  
ESQUEMA DE  
INSTALAÇÃO



+

Producto/Product  
Produit/Produto

Accesorios (NO Incluidos) / Accessoires (NOT Included) / Accessories (NON Inclus) / Acessórios (NÃO Incluso)









+ INFO PAG. 328

192606

Cable alimentación Transparente

# SCREENLIGHT 100



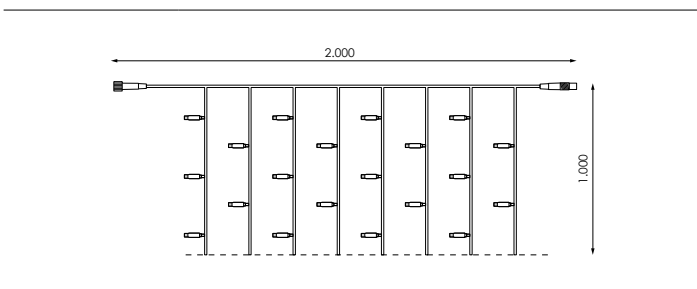

Interior





	230V dc
	50-60Hz
	CII
	1 CANAL
	IP20
	-20°C~+60 °C
	1kg (N.W.)
	NO INC.
	10ud



ESQUEMA INSTALACIÓN/  
INSTALLATION SCHEME/  
SCHEMA D'INSTALLATION/  
ESQUEMA DE  
INSTALAÇÃO

 + Producto/Product  
Produit/Produto





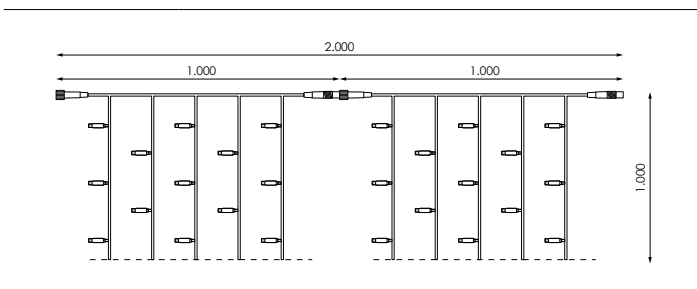

	2x1m
	20
	100
	5
<b>W</b>	7,5W
	10sets





		
547031		



ESQUEMA INSTALACIÓN/  
INSTALLATION SCHEME/  
SCHEMA D'INSTALLATION/  
ESQUEMA DE  
INSTALAÇÃO

 + Producto/Product  
Produit/Produto

	2x1m
	20
	2
	100
	5
<b>W</b>	8W
	10sets

		
504072		

Accesorios (NO Incluidos) / Accessoires (NOT Included) / Accessories (NON Inclus) / Acessórios (NÃO Incluso)

+ INFO PAG. 328

192606

Cable alimentación Transparente

# SCREENLIGHT 150

Interior



SMART LINK 

 230V dc

Hz 50-60Hz

 CII

 1 CANAL







 IP20





 -20°C~+60 °C

 1,5kg (N.W.)

 NO INC.

 10ud

		
547055		
547062		

	2x1,5m
	20
	150
	7/8
W	12W
	10sets

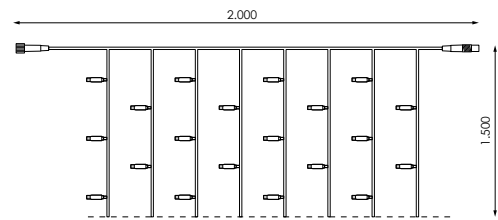





ESQUEMA INSTALACIÓN/  
INSTALLATION SCHEME/  
SCHEMA D'INSTALLATION/  
ESQUEMA DE  
INSTALAÇÃO









+

Producto/Product

Produit/Produto

		
504089		

	2x1,5m
	20
	4
	150
	7/8
W	15W
	10sets

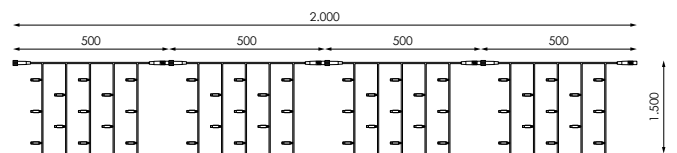

ESQUEMA INSTALACIÓN/  
INSTALLATION SCHEME/  
SCHEMA D'INSTALLATION/  
ESQUEMA DE  
INSTALAÇÃO



+

Producto/Product

Produit/Produto

Accesorios (NO Incluidos) / Accessoires (NOT Included) / Accessories (NON Inclus) / Acessórios (NÃO Incluso)

+ INFO PAG. 328









192606

Cable alimentación Transparente



# SCREENLIGHT 300

Interior

	230V dc
<b>Hz</b>	50-60Hz
	CII
	1 CANAL
	IP20
	-20°C~+60 °C
	3kg (N.W.)
	NO INC.
	10ud



SMART LINK 

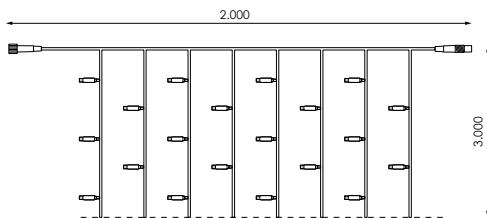

CC, Metromar  
Sevilla









ESQUEMA INSTALACIÓN/  
INSTALLATION SCHEME/  
SCHEMA D'INSTALLATION/  
ESQUEMA DE  
INSTALAÇÃO



Producto/Product  
Produit/Produto

	2x3m
	20
	300
	15
<b>W</b>	16W
	7sets

		
547079		
547086		

Accesorios (NO Incluidos) / Accessoires (NOT Included) / Accessories (NON Inclus)/ Acessórios (NÃO Incluso)

+ INFO PAG. 328

192606









Cable alimentación Transparente

# SCREENLIGHT 600

Interior









SMART LINK 

	230V dc
Hz	50-60Hz
	CII
	1 CANAL
	IP20
	-20°C~+60 °C
	7kg (N.W.)
	NO INC.
	10ud



CC. Lagoh  
Sevilla

		
547093		
547109		

	2x6m
	20
	600
	30
W	35W
	3sets

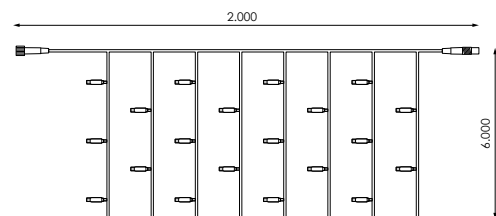

ESQUEMA INSTALACIÓN/  
INSTALLATION SCHEME/  
SCHEMA D'INSTALLATION/  
ESQUEMA DE  
INSTALAÇÃO



+

Producto/Product  
Produit/Produto

Accesorios (NO Incluidos) / Accessoires (NOT Included) / Accessories (NON Inclus) / Acessórios (NÃO Incluso)

+ INFO PAG. 328









192606

Cable alimentación Transparente



# SCREENLIGHT 150 Flashing

## Interior

	230V dc
<b>Hz</b>	50-60Hz
	CII
	1 CANAL
	IP20
	-20°C~+60 °C
	1,5kg (N.W.)
	NO INC.
	10ud

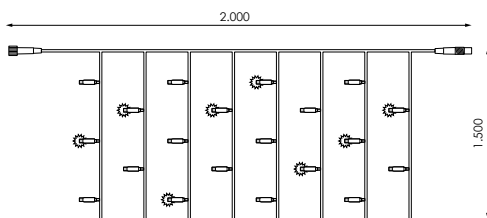













ESQUEMA INSTALACIÓN/  
INSTALLATION SCHEME/  
SCHEMA D'INSTALLATION/  
ESQUEMA DE  
INSTALAÇÃO



+

Producto/Product  
Produit/Produto

	2x1,5m
	20
	150
	5+2 flashing /6+2 flashing
<b>W</b>	12W
	10sets

		
547116		
547123		

Accesorios (NO Incluidos) / Accessoires (NOT Included) / Accessories (NON Inclus) / Acessórios (NÃO Incluso)

+ INFO PAG. 328

192606

Cable alimentación Transparente



# SCREENLIGHT 300 Flashing

Interior



CC. Abadía  
Toledo

 230V dc

 50-60Hz

 CII

 1 CANAL

 IP20









 -20°C~+60 °C







 3kg (N.W.)

 NO INC.

 10ud



		
547130	 	
547147	 	

	2x3m
	20
	300
	12+3 flashing
	17W
	7sets

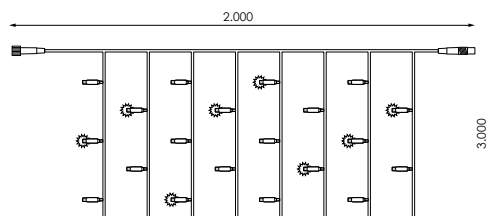

ESQUEMA INSTALACIÓN/  
INSTALLATION SCHEME/  
SCHEMA D'INSTALLATION/  
ESQUEMA DE  
INSTALAÇÃO



+

Producto/Product  
Produit/Produto

Accesorios (NO Incluidos) / Accessoires (NOT Included) / Accessories (NON Inclus) / Acessórios (NÃO Incluso)









+ INFO PAG. 328

192606

Cable alimentación Transparente

# SCREENLIGHT 600 Flashing

Interior

	230V dc
<b>Hz</b>	50-60Hz
	CII
	1 CANAL
	IP20
	-20°C~+60 °C
	7kg (N.W.)
	NO INC.
	10ud

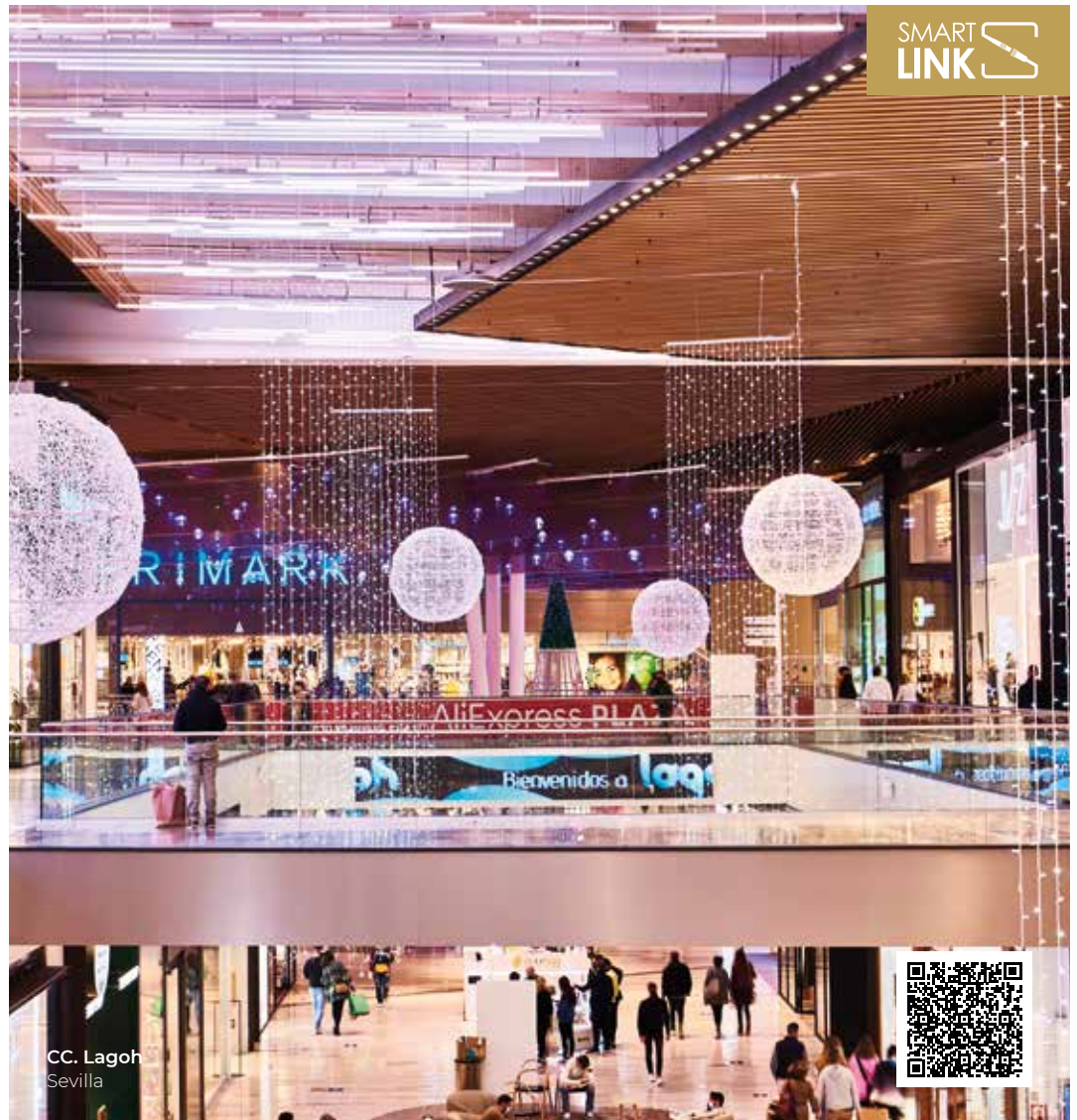

SMART LINK 



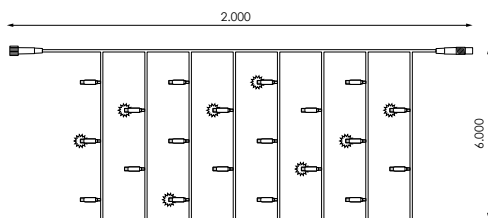

CC. Lagoh  
Sevilla











ESQUEMA INSTALACIÓN/  
INSTALLATION SCHEME/  
SCHEMA D'INSTALLATION/  
ESQUEMA DE  
INSTALAÇÃO



+ Producto/Product  
Produit/Produto

	2x6m
	20
	600
	24+6 flashing
<b>W</b>	35W
	3sets

		
547154	 	
547161	 	

Accesorios (NO Incluidos) / Accessoires (NOT Included) / Accessories (NON Inclus) / Acessórios (NÃO Incluso)

+ INFO PAG. 328

192606

Cable alimentación Transparente



# ICICLE<sup>®</sup> 102

Interior



SMART LINK

	230V dc
<b>Hz</b>	50-60Hz
	CII
	1 CANAL
	IP20
	-20°C~+60 °C
	1,4kg (N.W.)
	NO INC.
	10ud

CC. ABC Serrano  
Madrid

547178		
547185		

	3x1m (1,5m x 2seg)
	2
	102
	51
<b>W</b>	8W
	15sets

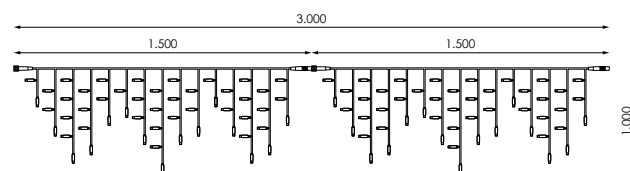

ESQUEMA INSTALACIÓN/  
INSTALLATION SCHEME/  
SCHEMA D'INSTALLATION/  
ESQUEMA DE  
INSTALAÇÃO



+

Producto/Product  
Produit/Produto

Accesorios (NO Incluidos) / Accessoires (NOT Included) / Accessories (NON Inclus) / Acessórios (NÃO Incluso)

+ INFO PAG. 328









192606

Cable alimentación Transparente



# ICICLE 102 Flashing

Interior

	230V dc
<b>Hz</b>	50-60Hz
	CII
	1 CANAL
	IP20
	-20°C~+60 °C
	1,4kg (N.W.)
	NO INC.
	10ud



SMART LINK 

[GRÁFICOS: Unidades en mm/ GRÁFICOS: Units in mm/ GRAPHICS: Units in mm/ GRÁFICOS: Unidades em mm]

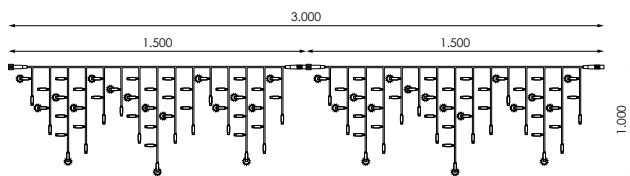















ESQUEMA INSTALACIÓN/  
INSTALLATION SCHEME/  
SCHEMA D'INSTALLATION/  
ESQUEMA DE  
INSTALAÇÃO



+

Producto/Product  
Produit/Produto

	3x1m (1,5m x 2seg)
	2
	102
	42+9 flashing
<b>W</b>	8W
	15sets

		
547192	 	
547208	 	

Accesorios (NO Incluidos) / Accessoires (NOT Included) / Accessories (NON Inclus) / Acessórios (NÃO Incluso)

+ INFO PAG. 328

192606

Cable alimentación Transparente

# Accesorios (NO Incluidos)

Accessoires (NOT Included)

Accessories (NON Inclus)

Acessórios (NÃO Incluso)

		STRING PLUS 100 exterior	STRING PLUS 100 FLASHING exterior	SCREENLIGHT exterior	SCREENLIGHT FLASHING exterior	ICICLE# 102 exterior	ICICLE# 102 FLASHING exterior	STRING PLUS 100 interior	SCREENLIGHT interior	SCREENLIGHT FLASHING interior	ICICLE# 102 interior	ICICLE# 102 FLASHING interior
⏏	192606							•	•	•	•	•
	977722	•	•	•	•	•	•					
	995092	•	•	•	•	•	•					
⏏	192323	•	•	•	•	•	•					
	192347	•	•	•	•	•	•					
	192354	•	•	•	•	•	•					
	192361	•	•	•	•	•	•					
	192378	•	•	•	•	•	•					
	192385	•	•	•	•	•	•					
	192392	•	•	•	•	•	•					
	192408	•	•	•	•	•	•					
	192415	•	•	•	•	•	•					
	192422	•	•	•	•	•	•					
	192439	•	•	•	•	•	•					
	192446	•	•	•	•	•	•					
	388368	•	•	•	•	•	•					
	388375	•	•	•	•	•	•					
	388382	•	•	•	•	•	•					
	388399	•	•	•	•	•	•					
	388498	•	•	•	•	•	•					
	388504	•	•	•	•	•	•					
	391498	•	•	•	•	•	•					
	391504	•	•	•	•	•	•					

CABLE ALIMENTACIÓN SMART LINK exterior

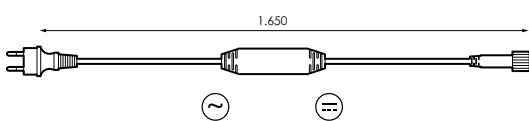

CABLE ALIMENTACIÓN SMART LINK interior

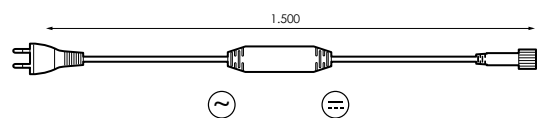

	⏏	⊕	⚡	W	□	⦿
995092	⦿	⊕	⚡	Max. 480W	CII	IP44 Plug IP65 Conector
977722	⦿	⊕	⚡	Max. 480W	CII	IP44 Plug IP65 Conector

	⏏	⊕	⚡	W	□	⦿
192606	⦿	⊕	⚡	Max. 480W	CII	IP20

### CONECTOR T SMART LINK

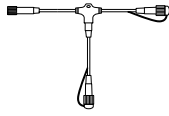

Barcode	Symbol	Quantity	IP Rating
192446		2	IP65
192439		2	IP65

### CONECTOR X SMART LINK

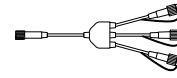

Barcode	Symbol	Quantity	IP Rating
391504		4	IP65
391498		4	IP65

### CONECTOR 5 SMART LINK

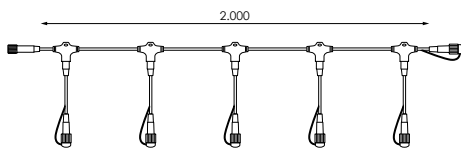

Barcode	Length	Quantity	Symbol	IP Rating
388375	2m	5		IP65
388368	2m	5		IP65

### CONECTOR 10 SMART LINK

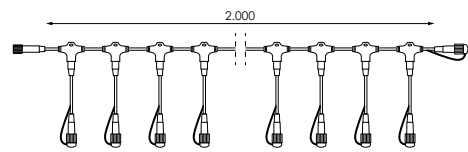

Barcode	Length	Quantity	Symbol	IP Rating
388399	2m	10		IP65
388382	2m	10		IP65

### CONECTOR 10 SMART LINK

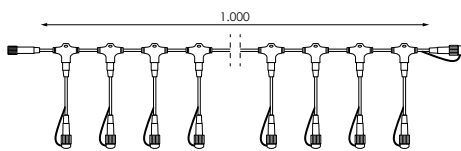

Barcode	Length	Quantity	Symbol	IP Rating
192408	1m	10		IP65
192392	1m	10		IP65

### CONECTOR 20 SMART LINK

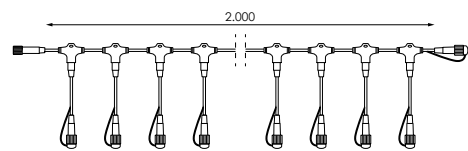

Barcode	Length	Quantity	Symbol	IP Rating
192422	2m	20		IP65
192415	2m	20		IP65

### EXTENSIÓN SMART LINK

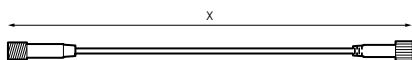

Barcode	Length	Symbol	IP Rating
388498	0,5m		IP65
388504	0,5m		IP65
192347	1m		IP65
192323	1m		IP65
192361	3m		IP65
192354	3m		IP65
192385	5m		IP65
192378	5m		IP65







# Led Exterior

Outdoors Led  
Led à l'exterieur  
Led ao ar livre

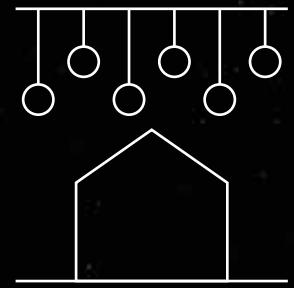

# String AVANT 180

IP67

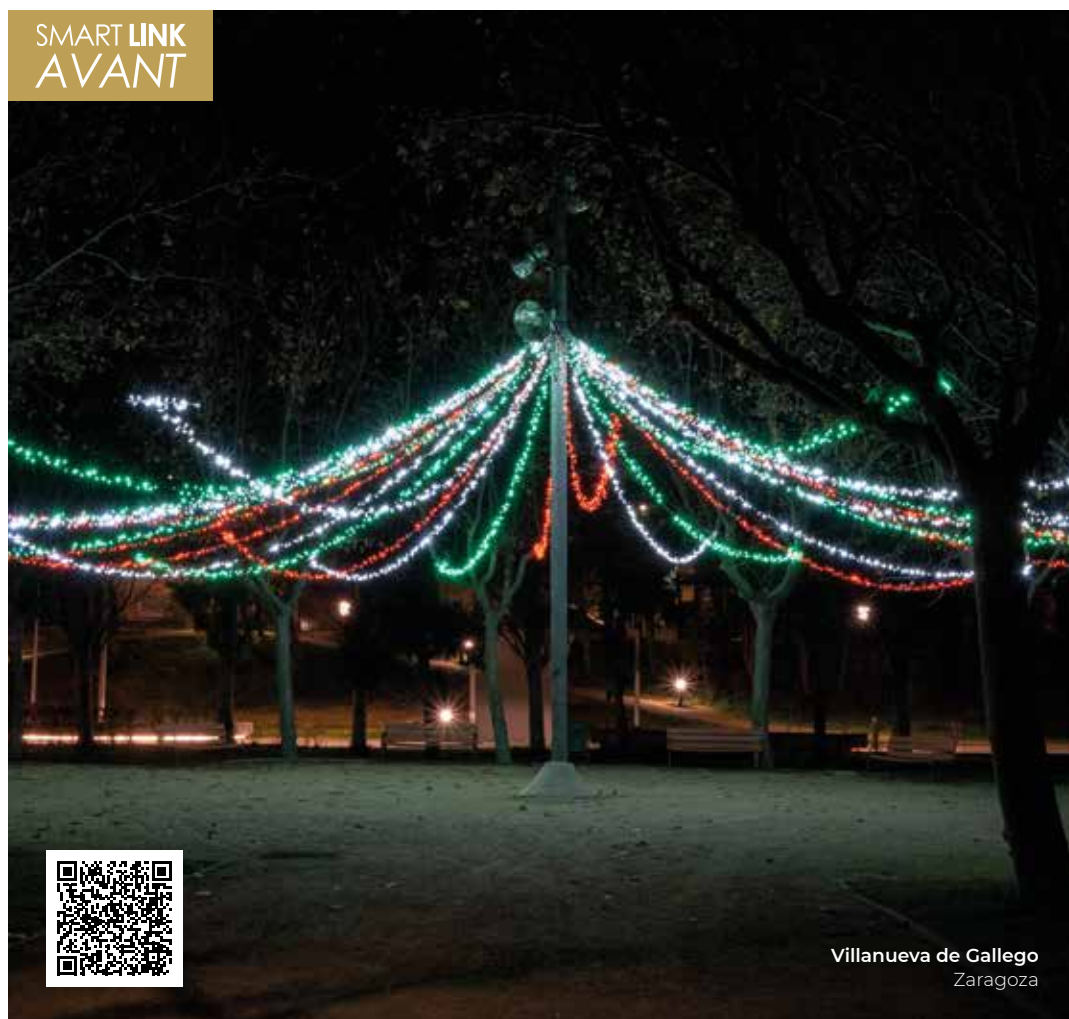

Villanueva de Gallego  
Zaragoza

	230V dc
<b>Hz</b>	50-60Hz
	CII
	1 CANAL
	IP67
	-20°C~+60 °C
	1,14kg (N.W.)
	NO INC.
	10ud

486941		
486958		
486965		
486972		
486989		
486996		
487009		
487016		
487023		
487030		

	12m (4m x 3seg)
	4m
	180
	60
<b>W</b>	10W
	3W
	100m

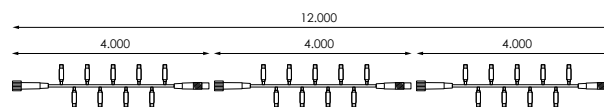

ESQUEMA INSTALACIÓN/  
INSTALLATION SCHEME/  
SCHÉMA D'INSTALLATION/  
ESQUEMA DE  
INSTALAÇÃO



+

Producto/Product  
Produit/Produto

Accesorios (NO Incluidos) / Accessoires (NOT Included) / Accessories (NON Inclus) / Acessórios (NÃO Incluso)

+ INFO PAG. 380

487207

Cable alimentación Negro

487214

Cable alimentación Blanco



# String AVANT 180

IP67 Flashing

	230V dc
<b>Hz</b>	50-60Hz
	CII
	1 CANAL
	IP67
	-20°C~+60 °C
	1,14kg (N.W.)
	NO INC.
	10ud



Galdar  
Canarias

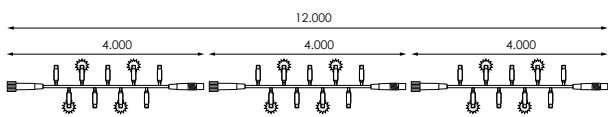

ESQUEMA INSTALACIÓN/  
INSTALLATION SCHEME/  
SCHEMA D'INSTALLATION/  
ESQUEMA DE  
INSTALAÇÃO



Producto/Product  
Produit/Produto

	12m (4m x 3seg)
	4m
	180
	50+10 flashing
<b>W</b>	10W
	3W
	100m

486873		
486880		
486859		
486866		
486897		
486903		
486910		
486927		
486934		

Accesorios (NO Incluidos) / Accessoires (NOT Included) / Accessories (NON Inclus) / Acessórios (NÃO Incluso)

+ INFO PAG. 380

487207

Cable alimentación Negro

487214

Cable alimentación Blanco

# STRING **PLUS** 180

## 24V Fuente Alimentación



	24V dc
	50-60Hz
	CIII
	1 CANAL
	IP65
	-20°C~+60 °C
	0,9kg (N.W.)
	NO INC.
	10ud

			W
149174			8W
146449			8,5W
505567			7W
505574			5,8W
191982			5,8W
441865			6,5W
477925			8,5W
441896			8,5W
441872			8,5W
441889			8,5W

	12m (4m x 3seg)
	4m
	180
	60
	*Accesorios

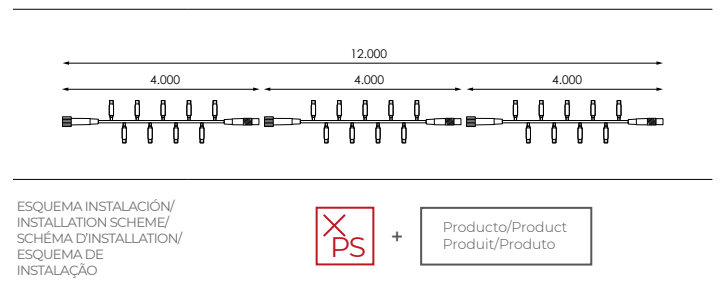

### Aviso/Warning/Avertissement/Aviso

**Ñ/** Uso **OBLIGATORIO** de fuente de alimentación.

**E/** You **MUST USE** the power supply.

**F/** L'utilisation **OBLIGATOIRE** du l'alimentation

**P/** Uso **OBRIGATÓRIO** fonte de alimentação.

### Accesorios (NO Incluidos) / Accessoires (NOT Included) / Accessories (NON Inclus)/ Acessórios (NÃO Incluso)

+ INFO PAG. 380

**Ñ/** Fuente de alimentación **NO INCLUIDA**

**E/** Power supply **NOT INCLUDED**

**F/** Alimentation **NON INCLUSE**

**P/** Fonte de alimentação **NÃO INCLUIDO**

488440	Fuente alimentación 30W 24V
488464	Fuente alimentación 100W 24V
481694	Fuente alimentación 200W 24V

488457	Fuente alimentación 60W 24V
481687	Fuente alimentación 150W 24V

488440	48m
488457	100m paralelo 48m en serie
488464	168m paralelo 48m en serie
481687	252m paralelo 48m en serie
481694	340m paralelo 48m en serie

# STRING **PLUS** 180

## 24V Flashing Fuente Alimentación

	24V dc
	50-60Hz
	CIII
	1 CANAL
	IP65
	-20°C~+60 °C
	0,9kg (N.W.)
	NO INC.
	10ud



Arcos Valdevez  
Portugal

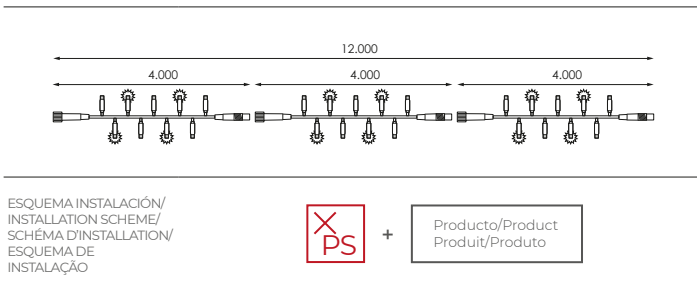

	12m (4m x 3seg)
	4m
	180
	50+10 flashing
	*Accesorios

413732				8,5W
413749				8,4W
505598				7,8W
505604				8,5W
561488				7,4W
561495				8,5W
561501				7,4W
<b>N</b> 598408				8,5W
542296				8,5W
505628				7,8W
505611				8,5W

### Aviso/Warning/Avertissement/Aviso

**Ñ/** Uso **OBLIGATORIO** de fuente de alimentación.

**E/** You **MUST USE** the power supply.

**F/** L'utilisation **OBLIGATOIRE** du l'alimentation

**P/** Uso **OBRIGATÓRIO** fonte de alimentação.

### Accesorios (NO Incluidos) / Accessoires (NOT Included) / Accessories (NON Inclus)/ Acessórios (NÃO Incluso)

+ INFO PAG. 380

**Ñ/** Fuente de alimentación **NO INCLUIDA**

**E/** Power supply **NOT INCLUDED**

**F/** Alimentation **NON INCLUSE**

**P/** Fonte de alimentação **NÃO INCLUIDO**

488440	Fuente alimentación 30W 24V
488464	Fuente alimentación 100W 24V
481694	Fuente alimentación 200W 24V

488457	Fuente alimentación 60W 24V
481687	Fuente alimentación 150W 24V

488440	48m
488457	100m paralelo 48m en serie
488464	168m paralelo 48m en serie
481687	252m paralelo 48m en serie
481694	340m paralelo 48m en serie



# STRING PLUS 180

## 24V Transformador



	24V dc
	50-60Hz
	CIII
	IP65
	-20°C~+60 °C
	0,9kg (N.W.)
	NO INC.
	NO INC.
	10ud

191968		
191975		
191999		
542258		
542265		
542289		
542234		
542319		
542326		

	12m (4m x 3seg)
	4m
	180
	60
	50+10 flashing
	9W
	3W
	*Accesorios

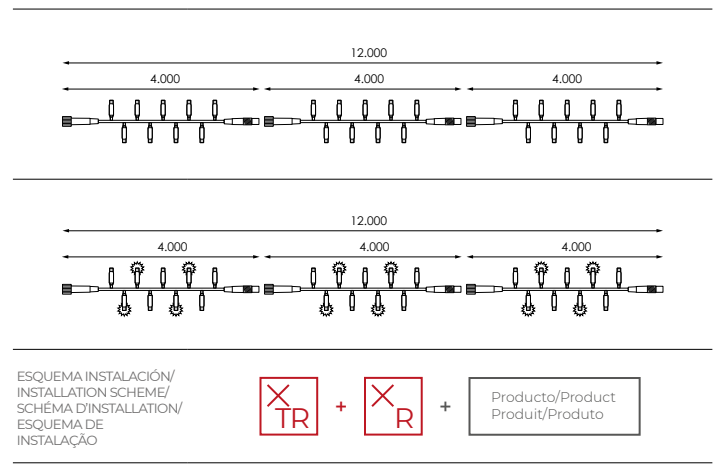

### Aviso/Warning/Avertissement/Aviso

**Ñ/** Uso **OBLIGATORIO** de transformador y rectificador. El transformador de 10,8W (149181), de 28,8W (149198) y de 60W (149204) se utilizarán con el rectificador máx. 60W (150323). El transformador de 120W (149211) se utilizará con el rectificador máx. 96W (364478).

**E/** You **MUST USE** the transformer and rectifier. The 10.8W, 28.8W and 60W transformers (149181/149198/149204) will be used with the rectifier 60W maximum (150323). The 120W transformer (149211) will be used with the rectifier 96W maximum (364478).

**F/** L'utilisation **OBLIGATOIRE** du transformateur et redresseur. Les transformateurs de 10.8W, 28.8W et 60W (149181/149198/149204) seront utilisés avec redresseur 60W au maximum (150323). Le transformateur de 120W (149211) est utilisée avec le redresseur 96W maximale (364478).

**P/** Uso **OBRIGATÓRIO** de transformador e retificador. Os transformadores de 10.8W, 28.8W e 60W (149181/149198/149204) serão usados com o retificador 60W máximo (150323). O transformador de 120W (149211) será usado com o retificador máximo 96W (364478).

### Accesorios (NO Incluidos) / Accessoires (NOT Included) / Accessories (NON Inclus)/ Acessórios (NÃO Incluso)

+ INFO PAG. 380

**Ñ/** Transformador y rectificador **NO INCLUIDO**

**E/** Transformer and rectifier **NOT INCLUDED**

**F/** Transformateur et redresseur **NON INCLUS**

**P/** Transformador e retificador **NÃO INCLUIDO**

149181	149198
Transformador 10,8W	Transformador 28,8W
149204	149211
Transformador 60W	Transformador 120W
150323	364478
Rectificador máx. 60W	Rectificador máx. 96W

149181	12m
149198	36m
149204	80m paralelo 48m en serie
149211	160m paralelo 48m en serie

# STRING **PLUS** 180

## 1 Sección

	230V dc
<b>Hz</b>	50-60Hz
	CII
	1 CANAL
	IP65
	-20°C~+60 °C
	0,9kg (N.W.)
	NO INC.
	10ud

**Ñ/ \*120LEDs / 12m / 2 Segmentos de 6m / Con cable de alimentación. E/ \*120LEDs / 12m / 2 Segments of 6m / With power cable. F/ \*120LEDs / 12m / 2 Segments de 6m / Avec câble d'alimentation. P/ \*120LEDs / 12m / 2 Segmentos de 6m / Com cabo de alimentação**



Maliaño  
Camargo, Santander

SMART  
LINK

[GRÁFICOS: Unidades en mm/ GRAPHICS: Units in mm/GRÁFICOS: Unidades em mm/ GRÁFICOS: Unidades em mm]

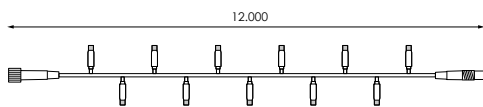

ESQUEMA INSTALACIÓN/  
INSTALLATION SCHEME/  
SCHEMA D'INSTALLATION/  
ESQUEMA DE  
INSTALAÇÃO



Producto/Product  
Produit/Produto

	12m
	12m
	180
<b>W</b>	11W
	100m

960847			
960786			
163521			
388146			
477994			
478021			
388115			
388122			
476010			
478014			
478007			
530293			
087773*			

Accesorios (NO Incluidos) / Accessoires (NOT Included) / Accessories (NON Inclus) / Acessórios (NÃO Incluso)

+ INFO PAG. 380

995092

Cable alimentación Negro

977722

Cable alimentación Blanco

# STRING **PLUS** 180

## Cápsula Clara



⚡	230V dc
Hz	50-60Hz
☐	CII
🎧	1 CANAL
🌡️	IP65
🌡️	-20°C~+60 °C
📊	1,14kg (N.W.)
⚡	NO INC.
📦	10ud

Barcode	LED	Cap	Eye
995108	LED	Cap	Eye
163651	LED	Cap	Eye
995115	LED	Cap	Eye
995122	LED	Cap	Eye
546577	LED	Cap	Eye
546584	LED	Cap	Eye
163477	LED	Cap	Eye
477987	LED	Cap	Eye
477949	LED	Cap	Eye
163507	LED	Cap	Eye
163491	LED	Cap	Eye
542227	LED	Cap	Eye
<b>N</b> 588614	LED	Cap	Eye
163514	LED	Cap	Eye
477932	LED	Cap	Eye
388153	LED	Cap	Eye
388160	LED	Cap	Eye

↔	12m (4m x 3seg)
⏏	4m
💡	180
💡	60
W	10W
⏏	3W
🔌	100m

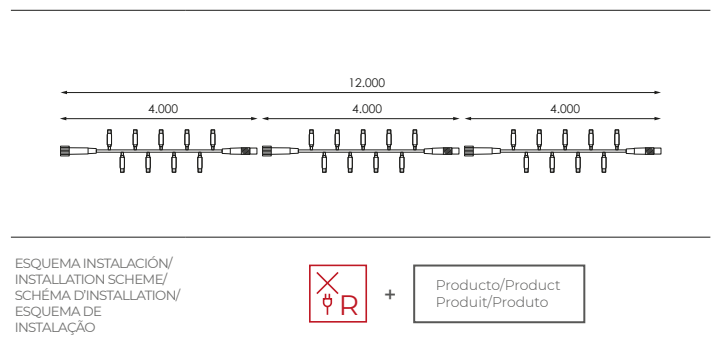

Accesorios (NO Incluidos) / Accessoires (NOT Included) / Accessories (NON Inclus) / Acessórios (NÃO Incluso)

+ INFO PAG. 380

995092  
Cable alimentación Negro

977722  
Cable alimentación Blanco



# STRING **PLUS** 180

## Cápsula Mate

	230V dc
<b>Hz</b>	50-60Hz
	CII
	1 CANAL
	IP65
	-20°C~+60 °C
	1,14kg (N.W.)
	NO INC.
	10ud



Palacio Episcopal  
Segovia

SMART  
LINK

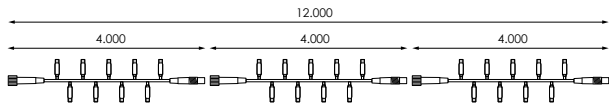

ESQUEMA INSTALACIÓN/  
INSTALLATION SCHEME/  
SCHEMA D'INSTALLATION/  
ESQUEMA DE  
INSTALAÇÃO



Producto/Product  
Produit/Produto

	12m (4m x 3seg)
	4m
	180
	60
<b>W</b>	10W
	3W
	100m

148894			
146227			
961165			
952361			
095587			
966450			
952392			
405829			
952378			
191951			
405836			
952385			
405843			
952408			
977241			

Accesorios (NO Incluidos) / Accessoires (NOT Included) / Accessories (NON Inclus) / Acessórios (NÃO Incluso)

+ INFO PAG. 380

995092

Cable alimentación Negro

977722

Cable alimentación Blanco

# STRING **PLUS** 120

All Flashing

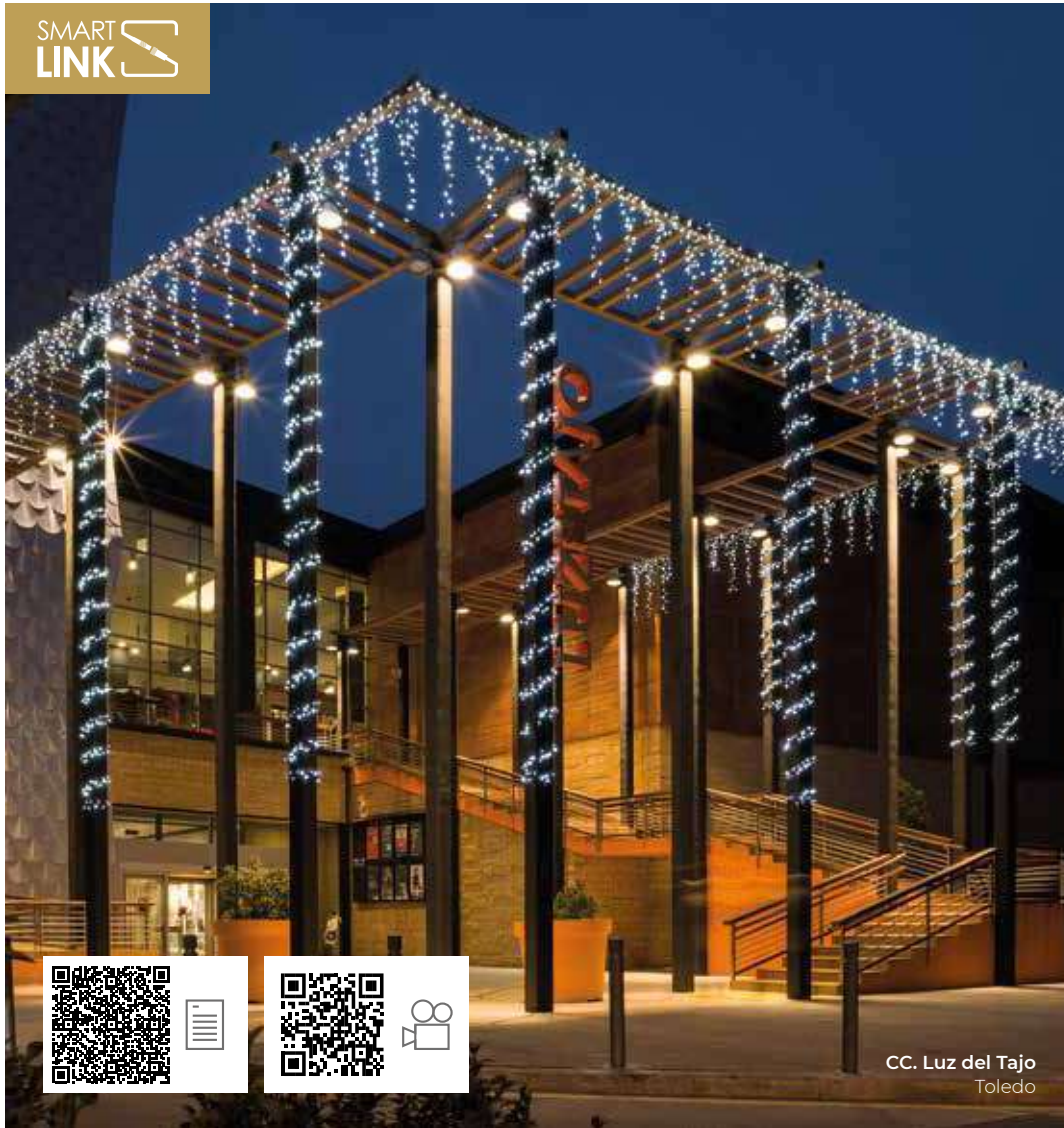

SMART  
LINK 

 230V dc

Hz 50-60Hz

 CII

 1 CANAL

 IP65

 -20°C~+60 °C







 0,9kg (N.W.)







 NO INC.

 10ud



CC. Luz del Tajo  
Toledo

		
977715		
995160		

	12m (4m x 3seg)
	4m
	120 flashing
	40 flashing
W	10,5W
	3,5W
	100m

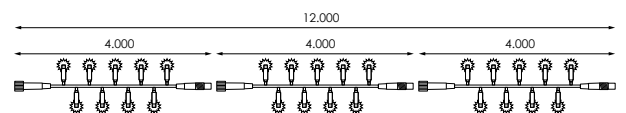

ESQUEMA INSTALACIÓN/  
INSTALLATION SCHEME/  
SCHEMA D'INSTALLATION/  
ESQUEMA DE  
INSTALAÇÃO



+

Producto/Product  
Produit/Produto

Accesorios (NO Incluidos) / Accessoires (NOT Included) / Accessories (NON Inclus) / Acessórios (NÃO Incluso)

+ INFO PAG. 380

995092

Cable alimentación Negro

977722

Cable alimentación Blanco

# STRING **PLUS** 180

## Sparkle Cápsula Clara

	230V dc
	50-60Hz
	CII
	1 CANAL
	IP65
	-20°C~+60 °C
	0,9kg (N.W.)
	NO INC.
	10ud



[GRÁFICOS: Unidades en mm/ GRAPPHICS: Units in mm/GRÁFICOS: Unidades em mm/GRÁFICOS: Unidades em mm]

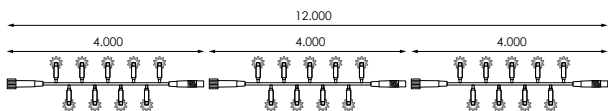

ESQUEMA INSTALACIÓN/  
INSTALLATION SCHEME/  
SCHÉMA D'INSTALLATION/  
ESQUEMA DE  
INSTALAÇÃO



Producto/Product  
Produit/Produto

	12m (4m x 3seg)
	4m
	180 sparkle
	60 sparkle
	9,5W
	3,2W
	100m

512480*			
512442			
512459			
512466			
512473			
512497			
512503			
512510			
512527			
512541			
512893			

### Información/Information/Information/Informações

**Ñ**/\* Multicolor.

**E**/\* Multicolored.

**F**/\* Multicolore.

**P**/\* Multicolorido.

Accesorios (NO Incluidos) / Accessoires (NOT Included) / Accessories (NON Inclus) / Acessórios (NÃO Incluso)

+ INFO PAG. 380

995092

Cable alimentación Negro

977722

Cable alimentación Blanco



# STRING **PLUS** 180

## Flashing Cápsula Clara



SMART  
LINK

⚡ 230V dc

Hz 50-60Hz

□ CII

🎧 1 CANAL

🌡️ IP65

🌡️ -20°C~+60 °C

📊 1,15kg (N.W.)

⊗ NO INC.

📦 10ud

Barcode	LED	Light	Eye
542357	LED	Light	Eye
542364	LED	Light	Eye
995146	LED	Light	Eye
977647	LED	Light	Eye
542388	LED	Light	Eye
542395	LED	Light	Eye
542371	LED	Light	Eye
542401	LED	Light	Eye
542418	LED	Light	Eye
512886	LED	Light	Eye

↔	12m (4m x 3seg)
s	4m
💡	180
💡	50+10 flashing
W	11W
w	3,5W
🔗	100m

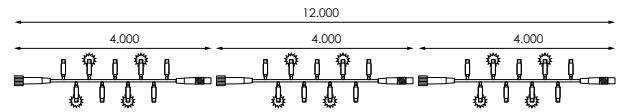

ESQUEMA INSTALACIÓN/  
INSTALLATION SCHEME/  
SCHEMA D'INSTALLATION/  
ESQUEMA DE  
INSTALAÇÃO



+

Producto/Product  
Produit/Produto

Accesorios (NO Incluidos) / Accessoires (NOT Included) / Accessories (NON Inclus) / Acessórios (NÃO Incluso)

+ INFO PAG. 380

995092

Cable alimentación Negro

977722

Cable alimentación Blanco

# STRING **PLUS** 180

## Flashing Cápsula Mate

	230V dc
<b>Hz</b>	50-60Hz
	CII
	1 CANAL
	IP65
	-20°C~+60 °C
	1,15kg (N.W.)
	NO INC.
	10ud



**N**  
NEW

SMART  
**LINK**

Santa Brígida  
Gran Canarias

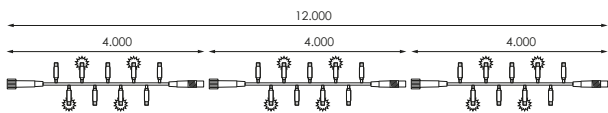

ESQUEMA INSTALACIÓN/  
INSTALLATION SCHEME/  
SCHEMA D'INSTALLATION/  
ESQUEMA DE  
INSTALAÇÃO



Producto/Product  
Produit/Produto

	12m (4m x 3seg)
	4m
	180
	50+10 flashing
<b>W</b>	11W
	3,5W
	100m

146234		
<b>N</b> 514460		
977661		
977678		
977685		
388184		

Accesorios (NO Incluidos) / Accessoires (NOT Included) / Accessories (NON Inclus) / Acessórios (NÃO Incluso)

+ INFO PAG. 380

995092

Cable alimentación Negro

977722

Cable alimentación Blanco

# Cluster Light

## Fall Lite 1m



SMART  
LINK

⚡ 230V

Hz 50-60Hz

☐ CII

☺ 1 CANAL

°° IP65

🌡 -20°C~+60 °C

📊 1,5kg (N.W.)

✗ NO INC.

☑ INC.

📏 10ud



PRODUCTO



PROYECTO



Santa Brígida  
Gran Canarias

388191		
388207		

↔	1m
∅	6cm
☼	50
W	2W
✗	NO Empalmable

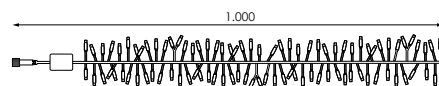

ESQUEMA INSTALACIÓN/  
INSTALLATION SCHEME/  
SCHEMA D'INSTALLATION/  
ESQUEMA DE  
INSTALAÇÃO



+

Producto/Product  
Produit/Produto

Accesorios (NO Incluidos) / Accessoires (NOT Included) / Accessories (NON Inclus) / Acessórios (NÃO Includo)

+ INFO PAG. 380

995092

Cable alimentación Negro

977722

Cable alimentación Blanco



# Cluster Light

## Fall Lite 3m

SMART  
LINK 















ESQUEMA INSTALACIÓN/  
INSTALLATION SCHEME/  
SCHEMA D'INSTALLATION/  
ESQUEMA DE  
INSTALAÇÃO



+

Producto/Product  
Produit/Produto

	3m
	6cm
	150
W	4,5W
	NO Empalmable

		
192057	 	
388214	 	

Accesorios (NO Incluidos) / Accessoires (NOT Included) / Accessories (NON Inclus)/ Acessórios (NÃO Incluso)

+ INFO PAG. 380

995092

Cable alimentación Negro

977722

Cable alimentación Blanco

# Cluster Light

## Fall Lite 5m

SMART  
LINK 















ESQUEMA INSTALACIÓN/  
INSTALLATION SCHEME/  
SCHEMA D'INSTALLATION/  
ESQUEMA DE  
INSTALAÇÃO



+

Producto/Product  
Produit/Produto

	5m
	6cm
	250
W	10,2W
	NO Empalmable

		
192064	 	
388221	 	

Accesorios (NO Incluidos) / Accessoires (NOT Included) / Accessories (NON Inclus)/ Acessórios (NÃO Incluso)

+ INFO PAG. 380

995092

Cable alimentación Negro

977722

Cable alimentación Blanco

# Cluster Light

## Flashing

SMART  
LINK 



Gran Hotel Los Abetos  
Santiago de Compostela

 230V dc

 50-60Hz

 CII











 IP65



 -20°C~+60 °C

 1,4kg (N.W.)

 NO INC.

 10ud

		
192026	  	
192033	  	

	2m
	160+40 flashing
W	15W
	7sets

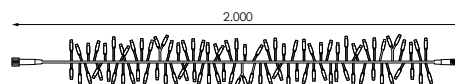

ESQUEMA INSTALACIÓN/  
INSTALLATION SCHEME/  
SCHEMA D'INSTALLATION/  
ESQUEMA DE  
INSTALAÇÃO



+

Producto/Product  
Produit/Produto

Accesorios (NO Incluidos) / Accessoires (NOT Included) / Accessories (NON Inclus) / Acessórios (NÃO Includo)









+ INFO PAG. 380

995092

Cable alimentación Negro

# Techo de Luz **SCREENLIGHT**

Flashing

	230V dc
<b>Hz</b>	50-60Hz
	CII
	1 CANAL
	IP65
	-20°C~+60 °C
	13,5kg (N.W.)
	NO INC.
	1ud

**N/** \*1 Led flashing cada 6 leds.  
**E/** \*1 Led flashing each 6 leds.  
**F/** \*1 Led clignotant chaque 6 leds.  
**P/** \*1 Led piscando cada 6 leds.





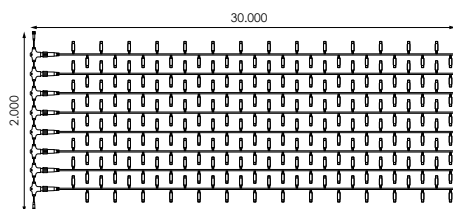









Guadalupe  
Cáceres



ESQUEMA INSTALCIÓN/  
 INSTALLATION SCHEME/  
 SCHEMA D'INSTALLATION/  
 ESQUEMA DE  
 INSTALAÇÃO



Producto/Product  
 Produit/Produto

	2x30m			
	8	386128		
	792	386135		
	83+16 flashing			
<b>W</b>	59W			
	NO Empalmable			

Accesorios (NO Incluidos) / Accessoires (NOT Included) / Accessories (NON Inclus)/ Acessórios (NÃO Incluso)

+ INFO PAG. 380

995092

Cable alimentación Negro



# Techo de Luz



	12V
	50-60Hz
	CIII
	1 CANAL
	IP44
	13,5kg (N.W.)
	INC.
	1ud



CC. La Villa  
La Orotava, (Tenerife)

546621		
546614		

	2x30m
	7
	693
	99
<b>W</b>	100W
	NO Empalmable

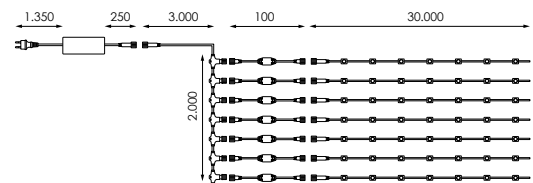

Accesorios (NO Incluidos) / Accessoires (NOT Included) / Accessories (NON Inclus) / Acessórios (NÃO Incluso)

+ INFO PAG. 380







499507

Protector sobretensiones y termorretráctil



# Techo de Luz

## Flashing





	12V
<b>Hz</b>	50-60Hz
	CIII
	1 CANAL
	IP44
	13,5kg (N.W.)
	INC.
	1ud



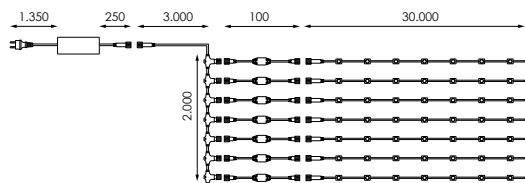



**Ñ/** \*1 Led flashing cada 9 leds.  
**E/** \*1 Led flashing each 9 leds.  
**F/** \*1 Led clignotant chaque 9 leds.  
**P/** \*1 Led piscando cada 9 leds.



Torrijos  
Toledo



	2x30m
	7
	693
	88+11 flashing
<b>W</b>	100W
	NO Empalmable

		
391375		
391382		

Accesorios (NO Incluidos) / Accessoires (NOT Included) / Accessories (NON Inclus) / Acessórios (NÃO Incluso)

+ INFO PAG. 380

499507

Protector sobretensiones y termo-retráctil

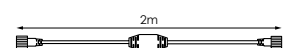



















# SCREENLIGHT 300

24V



Hotel Marconfort  
Benidorm

	24V dc
<b>Hz</b>	50-60Hz
	CIII
	1 CANAL
	IP65
	-20°C~+60 °C
	3kg (N.W.)
	NO INC.
	5ud

		
192132	 	
192149	 	

	2x1,5m
	20
	300
	15
<b>W</b>	14,7W
	Máx. 5 sets en serie

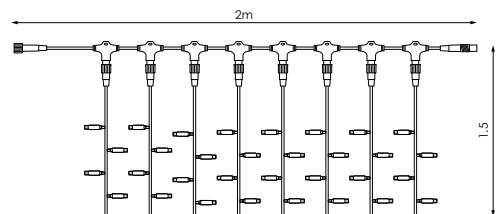

ESQUEMA INSTALACIÓN/  
INSTALLATION SCHEME/  
SCHEMA D'INSTALLATION/  
ESQUEMA DE  
INSTALAÇÃO



+

Producto/Product  
Produit/Produto

## Aviso/Warning/Avertissement/Aviso

Ñ/ Uso **OBLIGATORIO** de fuente de alimentación.

E/ You **MUST USE** the power supply.

F/ L'utilisation **OBLIGATOIRE** du l'alimentation

P/ Uso **OBRIGATÓRIO** fonte de alimentação.

## Accesorios (NO Incluidos) / Accessoires (NOT Included) / Accessoires (NON Inclus)/ Acessórios (NÃO Incluso)

+ INFO PAG. 380

Ñ/ Fuente de alimentación **NO INCLUIDA**

488440

Fuente alimentación 30W 24V

E/ Power supply **NOT INCLUDED**

481687

Fuente alimentación 150W 24V

F/ Alimentation **NON INCLUSE**

488457

Fuente alimentación 60W 24V

481694

Fuente alimentación 200W 24V

488464









Fuente alimentación 100W 24V

P/ Fonte de alimentação **NÃO INCLUIDO**



# SCREENLIGHT 600

24V

	24V dc
Hz	50-60Hz
	CIII
	1 CANAL
	IP65
	-20°C~+60 °C
	7kg (N.W.)
	NO INC.
	2ud



CC. Ferial Plaza  
Guadalajara

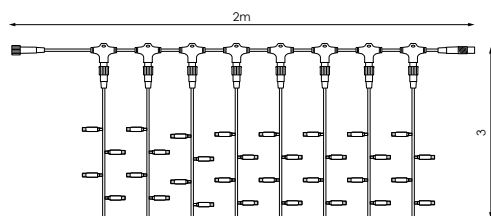







ESQUEMA INSTALACIÓN/  
INSTALLATION SCHEME/  
SCHEMA D'INSTALLATION/  
ESQUEMA DE  
INSTALAÇÃO



Producto/Product  
Produit/Produto

	2x3m
	20
	600
	30
W	28,5W
	Máx. 4 sets en serie

		
192156		
192163		

Aviso/Warning/Avertissement/Aviso

Ñ/ Uso **OBLIGATORIO** de fuente de alimentación.

E/ You **MUST USE** the power supply.

F/ L'utilisation **OBLIGATOIRE** du l'alimentation

P/ Uso **OBRIGATÓRIO** fonte de alimentação.

Accesorios (NO Incluidos) / Accessoires (NOT Included) / Accessories (NON Inclus)/ Acessórios (NÃO Incluso)

+ INFO PAG. 380

Ñ/ Fuente de alimentación **NO INCLUIDA**

488440

Fuente alimentación 30W 24V

E/ Power supply **NOT INCLUDED**

481687

Fuente alimentación 150W 24V

F/ Alimentation **NON INCLUSE**

P/ Fonte de alimentação **NÃO INCLUIDO**

488457

Fuente alimentación 60W 24V

481694

Fuente alimentación 200W 24V

488464

Fuente alimentación 100W 24V

# SCREENLIGHT 300



SMART LINK 



Guadalupe  
Cáceres

 230V dc

Hz 50-60Hz

 CII

 1 CANAL















 IP65





 -20°C~+60 °C

 3kg (N.W.)

 NO INC.

 5ud

		
953108	 	
995177	 	
995184	 	
953115	 	

	2x1,5m
	20 (2 tiras = 1 serie)
	300
	15
W	30W
	10sets

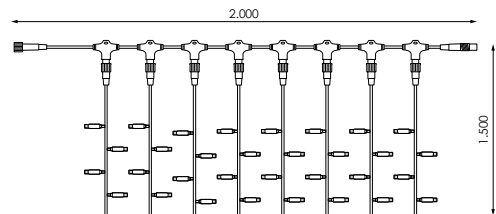

ESQUEMA INSTALACIÓN/  
INSTALLATION SCHEME/  
SCHEMA D'INSTALLATION/  
ESQUEMA DE  
INSTALAÇÃO



+

Producto/Product  
Produit/Produto

Accesorios (NO Incluidos) / Accessoires (NOT Included) / Accessories (NON Inclus) / Acessórios (NÃO Incluso)

+ INFO PAG. 380









995092

Cable alimentación Negro

977722

Cable alimentación Blanco

# SCREENLIGHT 600

	230V dc
Hz	50-60Hz
	CII
	1 CANAL
	IP65
	-20°C~+60 °C
	4,7kg (N.W.)
	NO INC.
	2ud

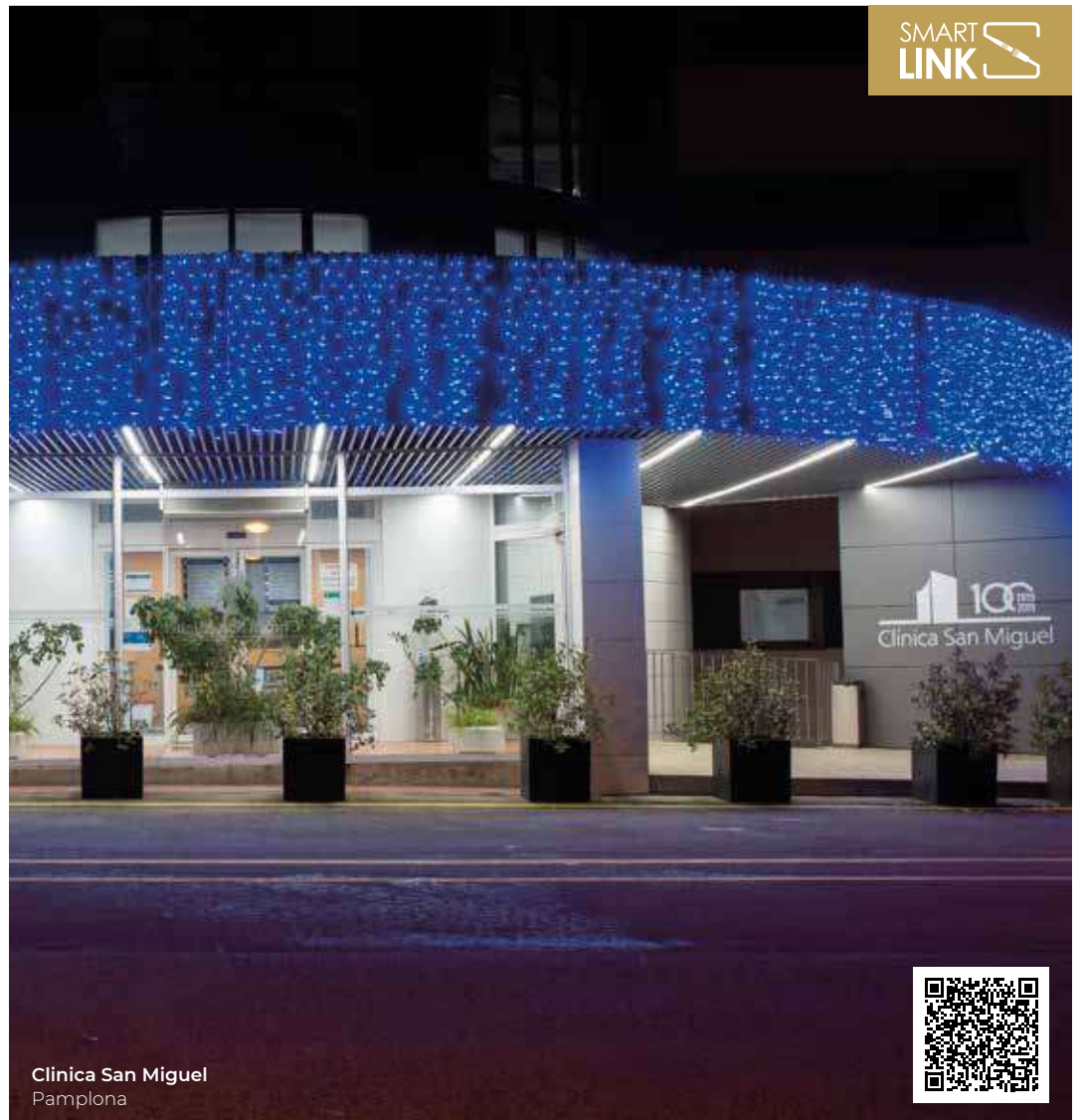

SMART LINK 

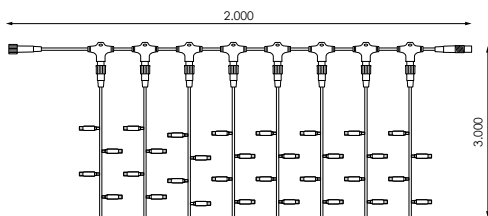

Clinica San Miguel  
Pamplona













ESQUEMA INSTALACIÓN/  
INSTALLATION SCHEME/  
SCHEMA D'INSTALLATION/  
ESQUEMA DE  
INSTALAÇÃO



+ Producto/Product  
Produit/Produto

	2x3m
	20 (2 tiras = 1 serie)
	600
	30
W	36,5W
	7sets

		
953153		
995191		
995207		
163712		

Accesorios (NO Incluidos) / Accessoires (NOT Included) / Accessories (NON Inclus) / Acessórios (NÃO Incluso)

+ INFO PAG. 380

995092

Cable alimentación Negro

977722

Cable alimentación Blanco



# SCREENLIGHT 1200

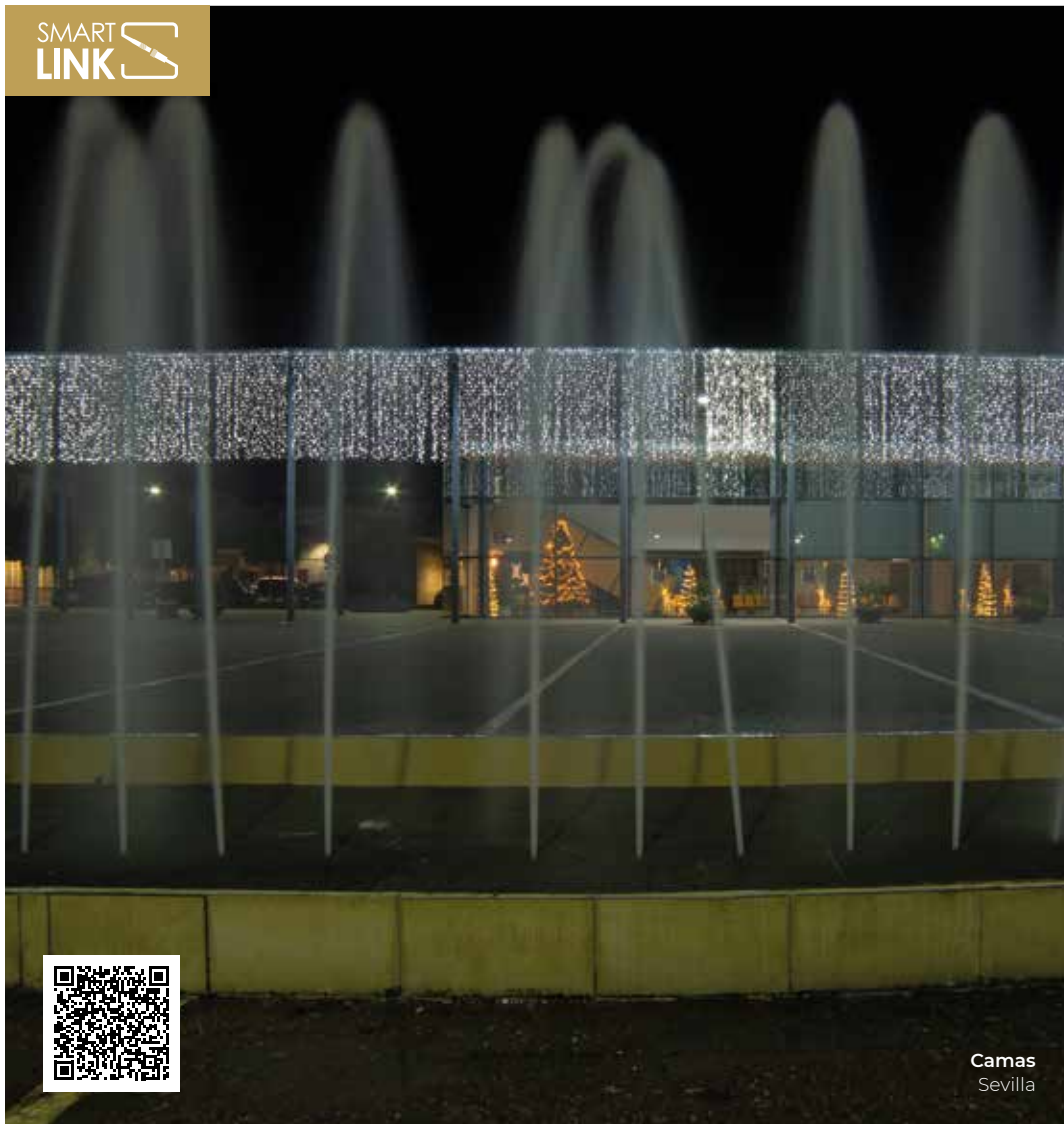

Camas  
Sevilla

 230V dc

 50-60Hz

 CII

 1 CANAL

 IP65















 -20°C~+60 °C





 8,7kg (N.W.)

 NO INC.

 2ud



		
953177	 	
163569	 	
163576	 	
092609	 	

	2x6m
	20
	1200
	60
<b>W</b>	74W
	3sets

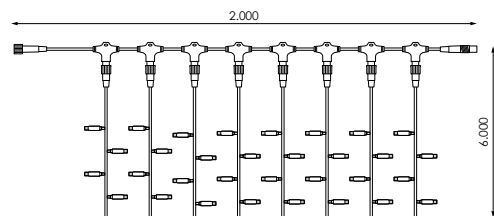

ESQUEMA INSTALACIÓN/  
INSTALLATION SCHEME/  
SCHEMA D'INSTALLATION/  
ESQUEMA DE  
INSTALAÇÃO



+

Producto/Product  
Produit/Produto

Accesorios (NO Incluidos) / Accessoires (NOT Included) / Accessories (NON Inclus) / Acessórios (NÃO Incluso)

+ INFO PAG. 380









995092

Cable alimentación Negro

977722

Cable alimentación Blanco

# SCREENLIGHT 1800

	230V dc
<b>Hz</b>	50-60Hz
	CII
	1 CANAL
	IP65
	-20°C~+60 °C
	13,5kg (N.W.)
	NO INC.
	1ud



San Brígida  
Gran Canarias

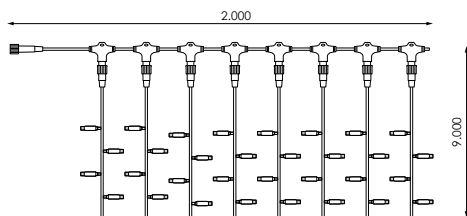













ESQUEMA INSTALACIÓN/  
INSTALLATION SCHEME/  
SCHEMA D'INSTALLATION/  
ESQUEMA DE  
INSTALAÇÃO



+

Producto/Product  
Produit/Produto

	2x9m
	20
	1800
	90
<b>W</b>	150W
	NO Empalmable

		
953191		
146241		

Accesorios (NO Incluidos) / Accessoires (NOT Included) / Accessories (NON Inklus) / Acessórios (NÃO Inklus)

+ INFO PAG. 380









977722











Cable alimentación Blanco





# SCREENLIGHT 300

Flashing



	230V dc
<b>Hz</b>	50-60Hz
	CII
	1 CANAL
	IP65
	-20°C~+60 °C
	3kg (N.W.)
	NO INC.
	5ud

		
146258	   	
146456	   	

	2x1,5m
	20 (2 tiras = 1 serie)
	300
	13+2 flashing
<b>W</b>	32W
	10sets

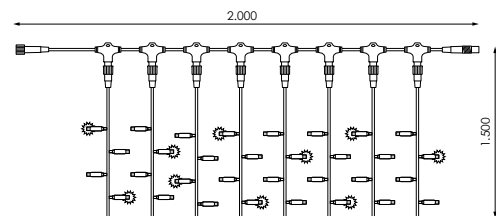

ESQUEMA INSTALACIÓN/  
INSTALLATION SCHEME/  
SCHEMA D'INSTALLATION/  
ESQUEMA DE  
INSTALAÇÃO



+

Producto/Product  
Produit/Produto

Accesorios (NO Incluidos) / Accessoires (NOT Included) / Accessories (NON Inclus) / Acessórios (NÃO Includo)

+ INFO PAG. 380









995092  
Cable alimentación Negro

977722  
Cable alimentación Blanco



# SCREENLIGHT 600

Flashing

	230V dc
<b>Hz</b>	50-60Hz
	CII
	1 CANAL
	IP65
	-20°C~+60 °C
	4,7kg (N.W.)
	NO INC.
	2ud



SMART LINK 



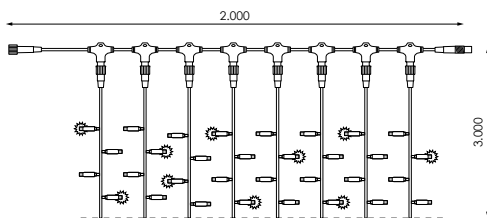









Restaurante La Santina  
Galapagar, Madrid



ESQUEMA INSTALACIÓN/  
INSTALLATION SCHEME/  
SCHEMA D'INSTALLATION/  
ESQUEMA DE  
INSTALAÇÃO



Producto/Product  
Produit/Produto

	2x3m			
	20 (2 tiras = 1 serie)	163606		
	600	146555		
	26+4 flashing			
<b>W</b>	38W			
	7sets			

Accesorios (NO Incluidos) / Accessoires (NOT Included) / Accessories (NON Inclus) / Acessórios (NÃO Incluso)

+ INFO PAG. 380

995092

Cable alimentación Negro









977722













Cable alimentación Blanco





# SCREENLIGHT 1200

Flashing



	230V dc
Hz	50-60Hz
	CII
	1 CANAL
	IP65
	-20°C~+60 °C
	8,7kg (N.W.)
	NO INC.
	2ud

		
163613	   	
146562	   	

	2x6m
	20
	1200
	54+6 flashing
W	73W
	3sets

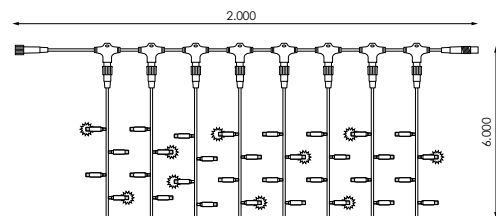

ESQUEMA INSTALACIÓN/  
INSTALLATION SCHEME/  
SCHEMA D'INSTALLATION/  
ESQUEMA DE  
INSTALAÇÃO



+

Producto/Product  
Produit/Produto

Accesorios (NO Incluidos) / Accessoires (NOT Included) / Accessories (NON Inclus) / Acessórios (NÃO Incluso)

+ INFO PAG. 380









995092  
Cable alimentación Negro

977722  
Cable alimentación Blanco



# SCREENLIGHT 1800

Flashing

	230V dc
Hz	50-60Hz
	CII
	1 CANAL
	IP65
	-20°C~+60 °C
	13,5kg (N.W.)
	NO INC.
	1ud

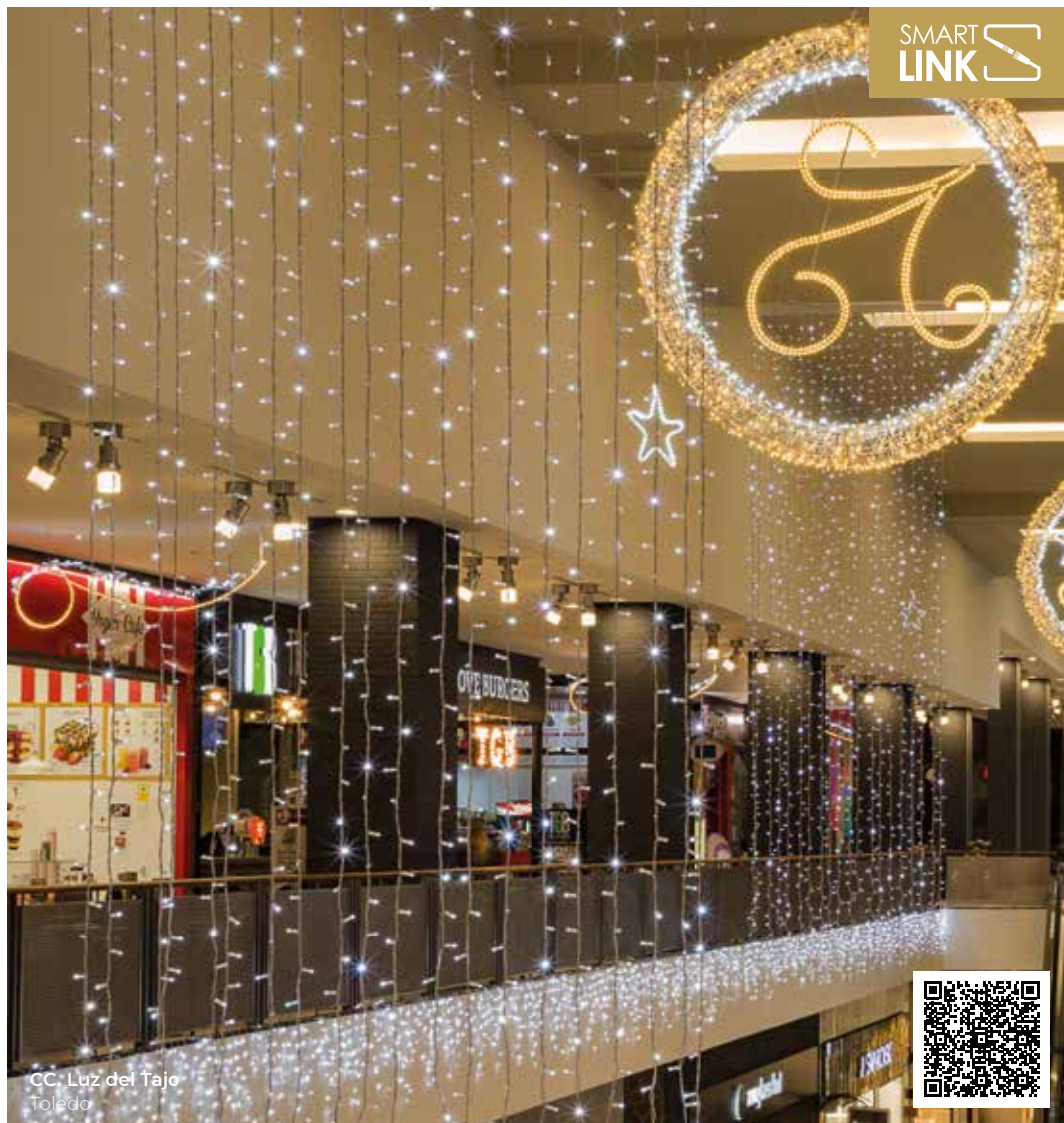

CC: Luz del Tajo  
Toledo

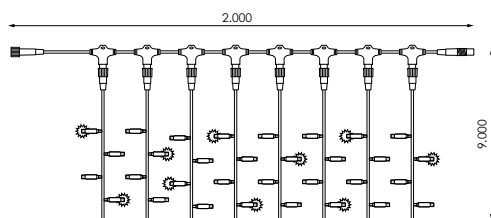







ESQUEMA INSTALACIÓN/  
INSTALLATION SCHEME/  
SCHEMA D'INSTALLATION/  
ESQUEMA DE  
INSTALAÇÃO



+ Producto/Product  
Produit/Produto

	2x9m
	20
	1800
	80+10 flashing
W	150W
	NO Empalmable

		
441698		
441704		

Accesorios (NO Incluidos) / Accessoires (NOT Included) / Accessories (NON Inclus) / Acessórios (NÃO Incluso)

+ INFO PAG. 380

995092

Cable alimentación Negro

977722









Cable alimentación Blanco



# SCREENLIGHT 300









Dual







	230V dc
<b>Hz</b>	50-60Hz
	CII
	1 CANAL
	IP44
	-20°C~+60 °C
	3kg (N.W.)
	NO INC.
	5ud



**MALL DEL PACIFICO**  
CC. Mall del Pacífico  
Manta, Ecuador

		
192071		
192088		
192095		

	2x1,5m
	20
	300
	15
<b>W</b>	33W
	*Accesorios

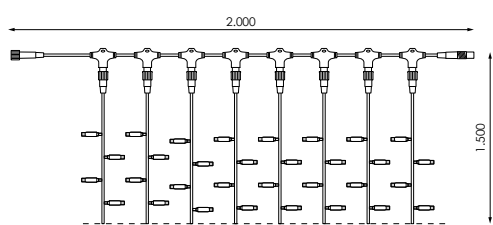

ESQUEMA INSTALACIÓN/  
INSTALLATION SCHEME/  
SCHÉMA D'INSTALLATION/  
ESQUEMA DE  
INSTALAÇÃO



+ Producto/Product  
Produit/Produto

## Aviso/Warning/Avertissement/Aviso

**Ñ**/ Los efectos de cambio de color solo funcionan con el controlador que es de **USO OBLIGATORIO**.

**E**/ The color change effects only work with the controller that is **OBLIGATORY**.

**F**/ Les effets de changement de couleur fonctionnent uniquement avec le contrôleur qui est **OBLIGATOIRE**.

**P**/ Os efeitos de mudança de cor funcionam apenas com o controlador que é **USO OBRIGATORIO**.

## Accesorios (NO Incluidos) / Accessoires (NOT Included) / Accessories (NON Inclus)/ Acessórios (NÃO Incluso)

+ INFO PAG. 380



**Ñ**/ La máxima longitud por alimentación, dependerá del controlador a utilizar. Controlador **NO INCLUIDO**.

**E**/ Maximum length for power, will depend on the driver to use. Controller **NOT INCLUDED**.

**F**/ Longueur maximale pour le pouvoir, dépendra le pilote à utiliser. Contrôleur **NON INCLUS**.

**P**/ Comprimento máximo para o poder, vai depender do driver para uso. Controlador **NÃO INCLUIDO**.

971072	Controlador 4 funciones 6A
391559	Controlador 8 funciones 2A blanco

	
971072	max. 7 set/salida
391559	7 sets

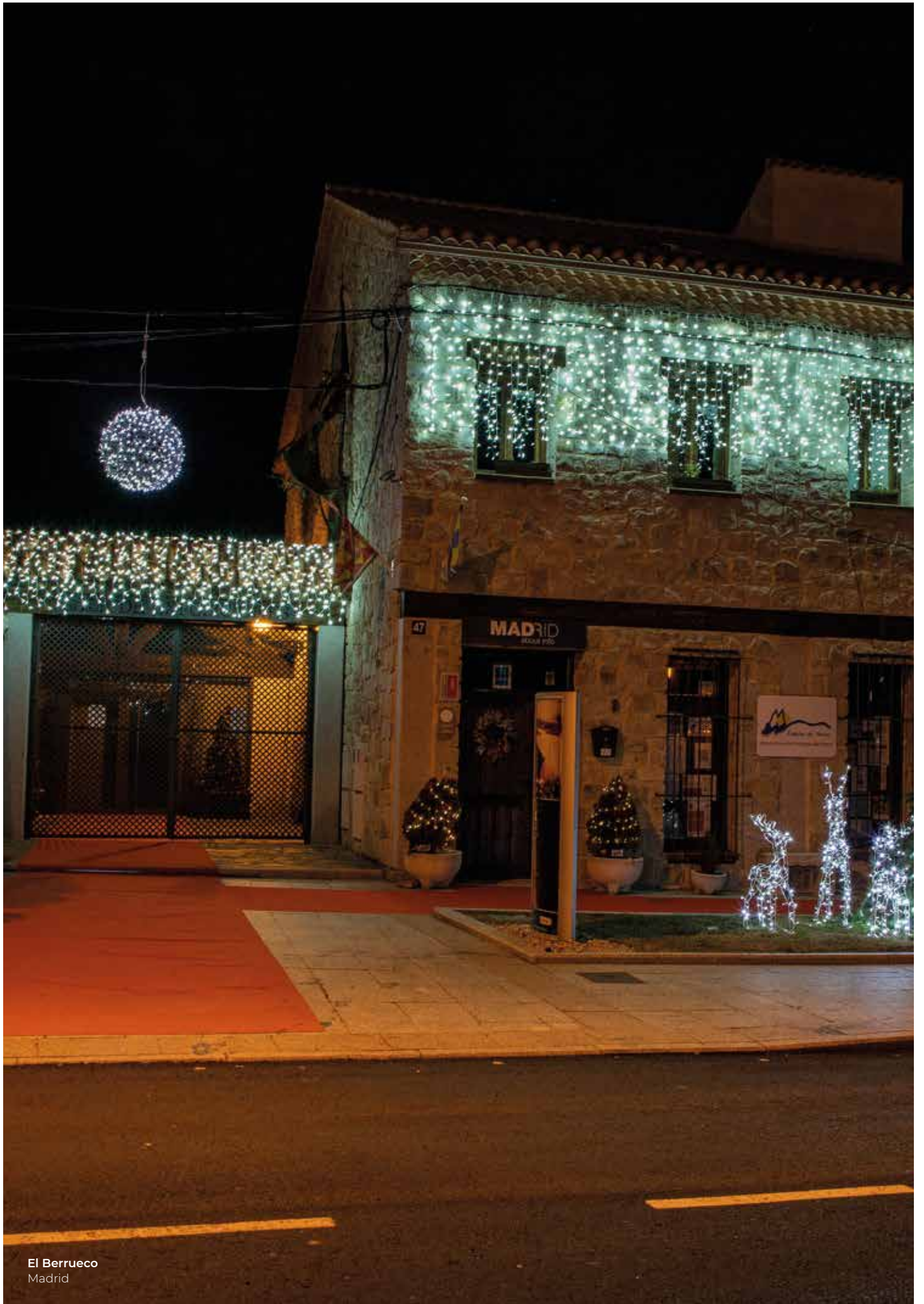

El Berrueco  
Madrid











# SCREENLIGHT 250







Fall Lite







SMART LINK 

	230V dc
	50-60Hz
	CII
	1 CANAL
	IP65
	-20°C~+60 °C
	3kg (N.W.)
	NO INC.
	5ud



		
388238		
388245		

	2x1m
	5
	250
	50
<b>W</b>	5,5W
	15sets

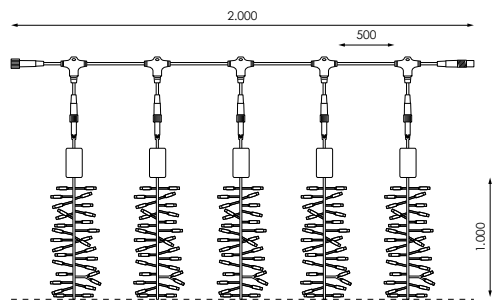

ESQUEMA INSTALACIÓN/  
INSTALLATION SCHEME/  
SCHEMA D'INSTALLATION/  
ESQUEMA DE  
INSTALAÇÃO



+

Producto/Product  
Produit/Produto

Accesorios (NO Incluidos) / Accessoires (NOT Included) / Accessories (NON Inclus)/ Acessórios (NÃO Incluso)

+ INFO PAG. 380









193078

Cable alimentación Blanco



# SCREEN Rain

2x2m









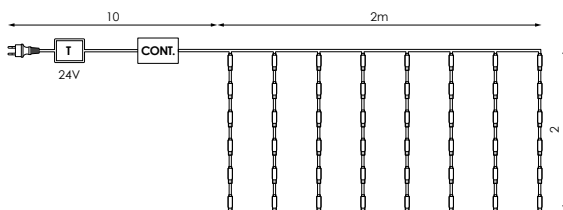

	24V
<b>Hz</b>	50-60Hz
	CIII
	4 CANALES
	IP44
	-20°C~+60 °C
	3kg (N.W.)
	INC.
	5ud

**N/** Controlador efecto lluvia ajustable en velocidad **INCLUIDO**.  
**E/** Controller adjustable rain's effect in speed **INCLUDED**.  
**F/** Contrôleur effet vitesse réglable de pluie **INCLUS**.  
**P/** Controlador ajustável chuva na velocidade **INCLUIDO**.



Fuensalida  
Toledo



	2x2m			
	16	441711		
	512			
	32			
<b>W</b>	17W			
	NO Empalnable			

# ICICLE 114



SMART  
LINK

⚡ 230V dc

Hz 50-60Hz

☐ CII

☺ 1 CANAL

°° IP65

🌡️ -20°C~+60 °C

📊/kg 1kg (N.W.)

✗ NO INC.

📦 10ud

CC. Lagoh  
Sevilla



977692		
146364		
163620		
163637		

	3x0,5m (1,5m x 2seg)
	2
	114
	57
W	8W
	20sets

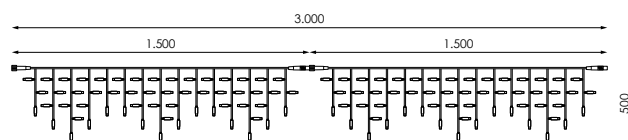

ESQUEMA INSTALACIÓN/  
INSTALLATION SCHEME/  
SCHEMA D'INSTALLATION/  
ESQUEMA DE  
INSTALAÇÃO



+

Producto/Product  
Produit/Produto

Accesorios (NO Incluidos) / Accessoires (NOT Included) / Accessories (NON Inclus) / Acessórios (NÃO Incluso)

+ INFO PAG. 380

995092

Cable alimentación Negro

977722

Cable alimentación Blanco

SMART LINK

	230V dc
<b>Hz</b>	50-60Hz
	CII
	1 CANAL
	IP65
	-20°C~+60 °C
	1,7kg (N.W.)
	NO INC.
	10ud

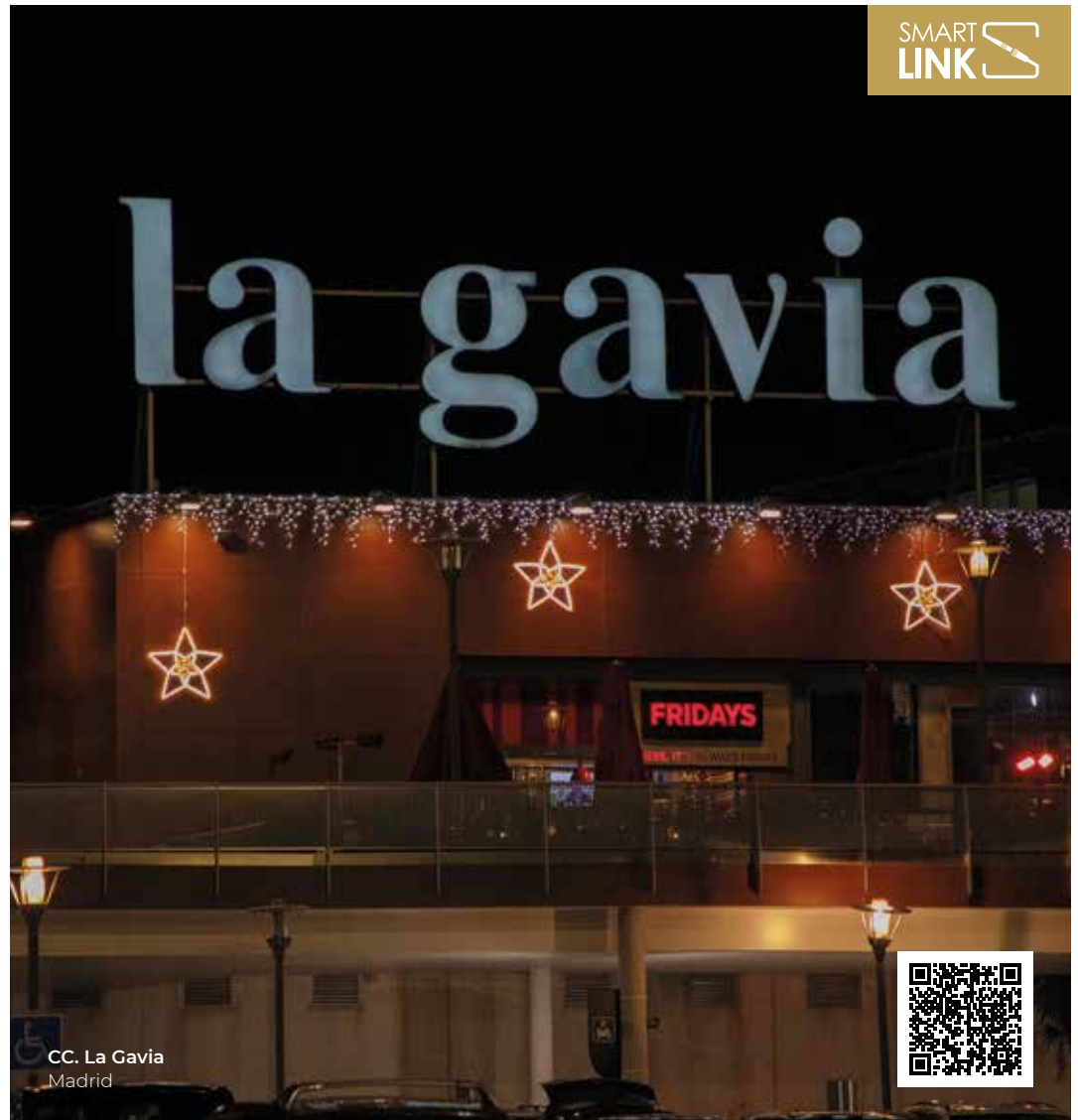

CC. La Gavia  
Madrid

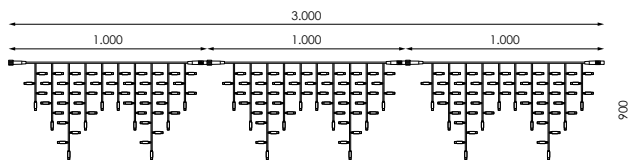

ESQUEMA INSTALACIÓN/  
INSTALLATION SCHEME/  
SCHEMA D'INSTALLATION/  
ESQUEMA DE  
INSTALAÇÃO



+

Producto/Product  
Produit/Produto

	3x0,9m (1m x 3seg)
	Nº 3
	174
	58
<b>W</b>	12W
	15sets

163644		
163552		
161305		
543026		

Accesorios (NO Incluidos) / Accessoires (NOT Included) / Accessories (NON Inclus) / Acessórios (NÃO Incluso)

+ INFO PAG. 380

995092

Cable alimentación Negro

977722

Cable alimentación Blanco



# ICICLE<sup>®</sup> 304

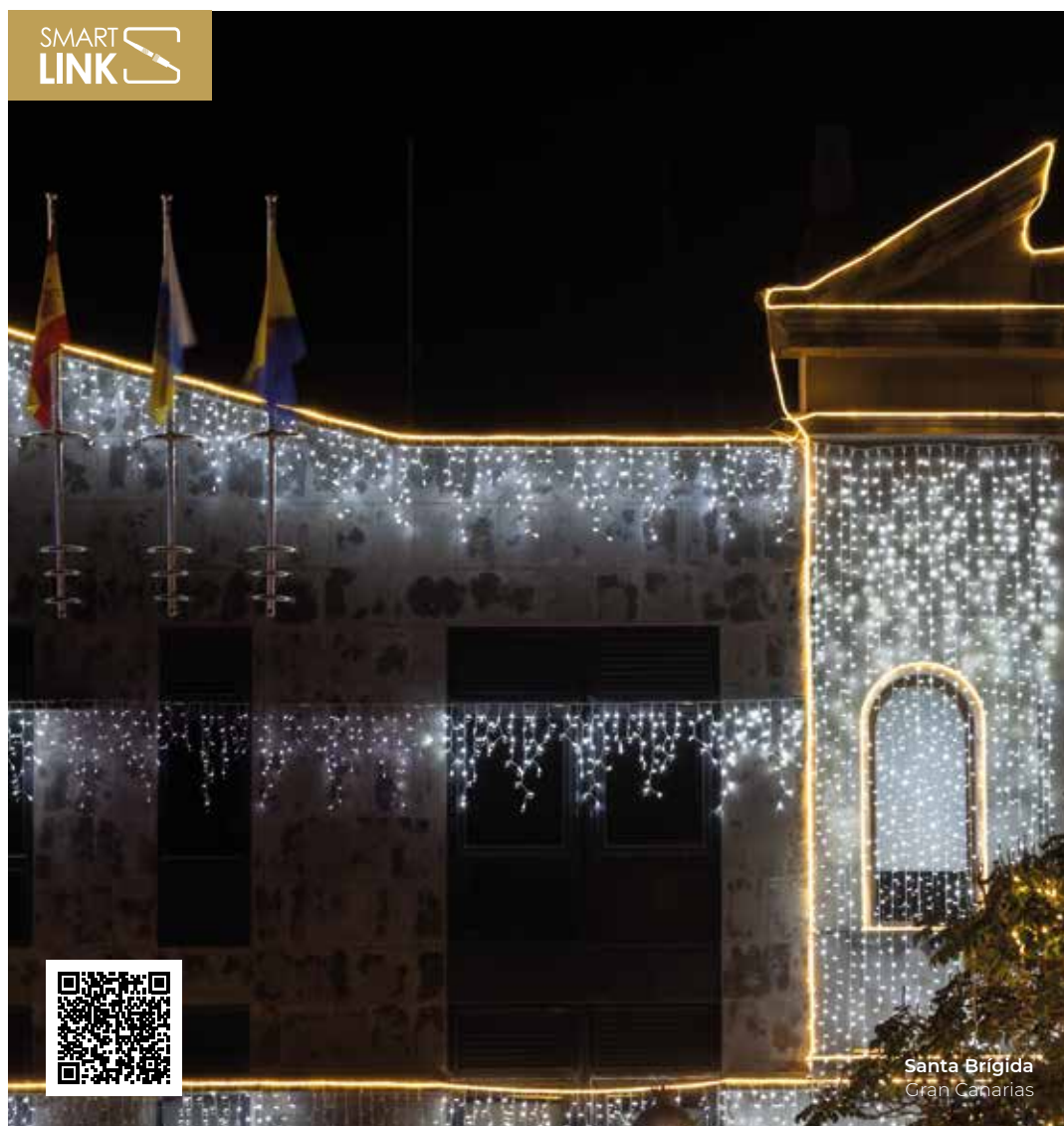

SMART  
LINK

⚡ 230V dc

Hz 50-60Hz

□ CII

🗎 1 CANAL

🌡 IP65

🌡 -20°C~+60 °C

📊 2,7kg (N.W.)

⊗ NO INC.

📦 6ud



Santa Brígida  
Gran Canarias

Barcode	LED	Light Icon	Eye Icon
163675	LED	Light Icon	Eye Icon
163682	LED	Light Icon	Eye Icon
163699	LED	Light Icon	Eye Icon
163705	LED	Light Icon	Eye Icon

↕	4x1,5m (1m x 4seg)
N°	4
💡	304
💡	76
W	27,5W
🔌	10sets

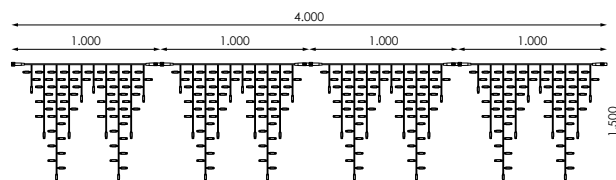

ESQUEMA INSTALACIÓN/  
INSTALLATION SCHEME/  
SCHEMA D'INSTALLATION/  
ESQUEMA DE  
INSTALAÇÃO



+

Producto/Product  
Produit/Produto

Accesorios (NO Incluidos) / Accessoires (NOT Included) / Accessories (NON Inclus) / Acessórios (NÃO Incluso)

+ INFO PAG. 380

995092









Cable alimentación Negro

977722

Cable alimentación Blanco

# ICICLE 114

Flashing

	230V dc
<b>Hz</b>	50-60Hz
	CII
	1 CANAL
	IP65
	-20°C~+60 °C
	1kg (N.W.)
	NO INC.
	10ud



SMART LINK 

CC. Lagoh  
Sevilla

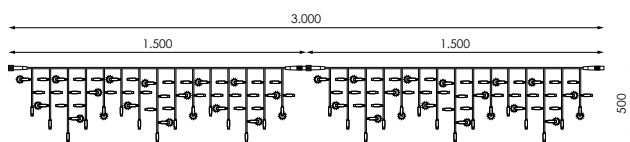
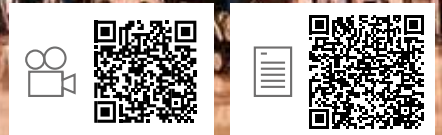















ESQUEMA INSTALACIÓN/  
INSTALLATION SCHEME/  
SCHEMA D'INSTALLATION/  
ESQUEMA DE  
INSTALAÇÃO



+

Producto/Product  
Produit/Produto

	3x0,5m (1,5m x 2seg)			
	2	146388		
	114	146371		
	49+8 flashing	543019		
<b>W</b>	8,5W			
	20sets			

Accesorios (NO Incluidos) / Accessoires (NOT Included) / Accessories (NON Inklus) / Acessórios (NÃO Inklus)

+ INFO PAG. 380

995092

Cable alimentación Negro

977722

Cable alimentación Blanco



# ICICLE<sup>®</sup> 174

## Flashing



SMART LINK

	230V dc
	50-60Hz
	CII
	1 CANAL
	IP65
	-20°C~+60 °C
	1,7kg (N.W.)
	NO INC.
	10ud



CC. Metroma  
Sevilla

146395		
146401		
543033		

	3x0,9m (1m x 3seg)
	3
	174
	50+8 flashing
	12W
	15sets

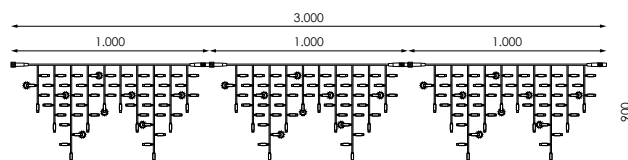

ESQUEMA INSTALACIÓN/  
INSTALLATION SCHEME/  
SCHEMA D'INSTALLATION/  
ESQUEMA DE  
INSTALAÇÃO



+

Producto/Product  
Produit/Produto

Accesorios (NO Incluidos) / Accessoires (NOT Included) / Accessories (NON Inclus) / Acessórios (NÃO Includo)

+ INFO PAG. 380

995092

Cable alimentación Negro

977722

Cable alimentación Blanco



# ICICLE 304

Flashing

SMART LINK

	230V dc
<b>Hz</b>	50-60Hz
	CII
	1 CANAL
	IP65
	-20°C~+60 °C
	2,7kg (N.W.)
	NO INC.
	5ud

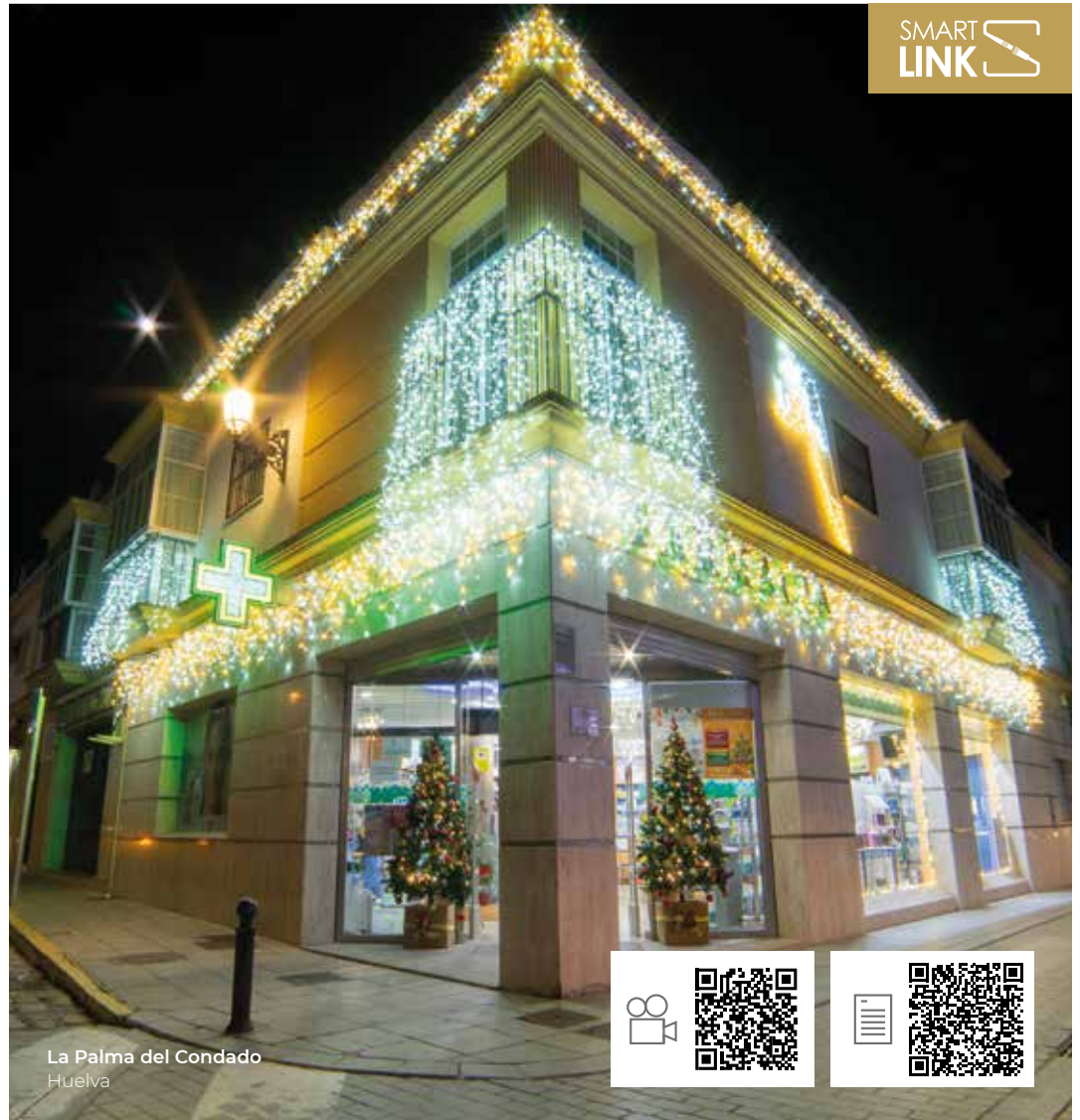

La Palma del Condado  
Huelva

[GRÁFICOS: Unidades en mm/ GRÁFICOS: Units in mm/ GRAPHICS: Units in mm/ GRÁFICOS: Unidades em mm]

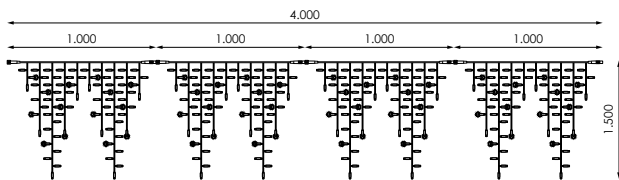

ESQUEMA INSTALACIÓN/  
INSTALLATION SCHEME/  
SCHEMA D'INSTALLATION/  
ESQUEMA DE  
INSTALAÇÃO



+ Producto/Product  
Produit/Produto

	4x1,5m (1m x 4seg)			
<b>Nº</b>	4	546591		
	304	546607		
	66+10 flashing			
<b>W</b>	27,5W			
	10sets			

Accesorios (NO Incluidos) / Accessoires (NOT Included) / Accessories (NON Inclus) / Acessórios (NÃO Incluso)

+ INFO PAG. 380

995092

Cable alimentación Negro

977722

Cable alimentación Blanco

# Cascada

4m

075824		
192187		
075817		

	4m
	5
	480
	96
<b>W</b>	26W
	NO Empalmable

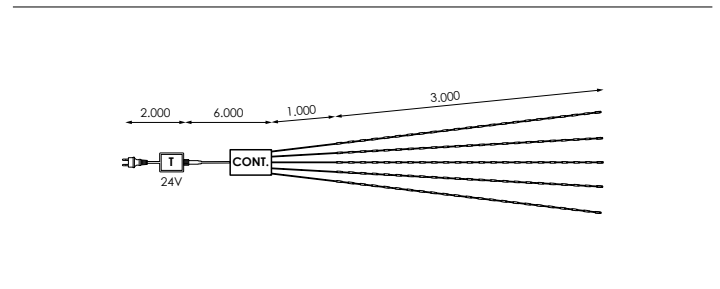

## Información/Information/Information/Informações

Ñ/ Controlador 8 funciones **INCLUIDO.**

E/ Controller 8 functions **IN-CLUDED.**

F/ Contrôleur 8 fonctions **INCLUS.**

P/ Controlador 8 funções **INCLUIDO.**

# Cascada

7m

075848		
192194		
075831		

	7m
	5
	960
	192
<b>W</b>	40W
	NO Empalmable

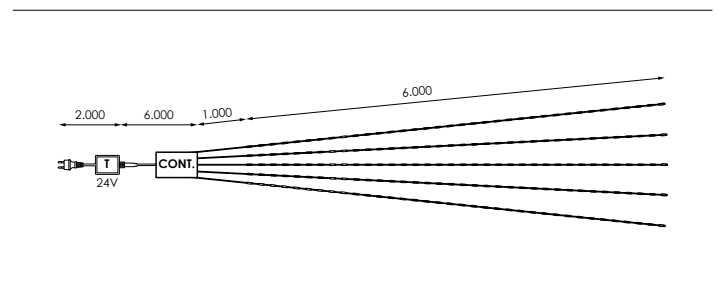

## Información/Information/Information/Informações

Ñ/ Controlador 8 funciones **INCLUIDO.**

E/ Controller 8 functions **IN-CLUDED.**

F/ Contrôleur 8 fonctions **INCLUS.**

P/ Controlador 8 funções **INCLUIDO.**

# Cascada

⚡ 24V

Hz 50-60Hz

⚡ CIII

👁️ 4 CANALES

🌧️ IP44

📊 1,6kg (N.W.)

📦 INC.

📦 6ud (4m)

📦 4ud (7m)













# SCREENLIGHT Cascada







2x1,5m







	24V
	50-60Hz
	CIII
	4 CANALES
	IP44
	3kg (N.W.)
	INC.
	2ud



Beniflá  
Valencia

		
087094		
087100		

	2x1,5m
	16
	768
	48
<b>W</b>	35W
	NO Empalmable

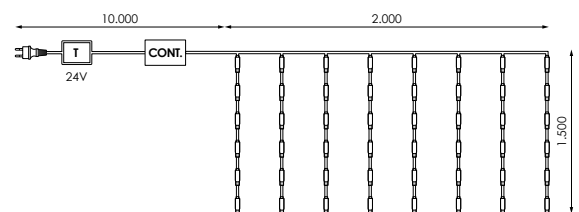

## Información/Information/Information/Informações









Ñ/ Controlador 8 funciones **INCLUIDO.**

E/ Controller 8 functions **IN-  
CLUDED.**

F/ Contrôleur 8 fonctions **INCLUS.**

P/ Controlador 8 funções **INCLUIDO.**









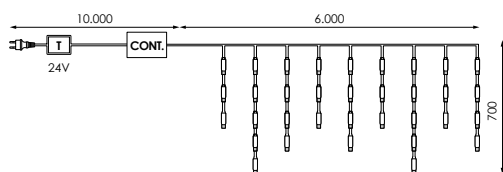
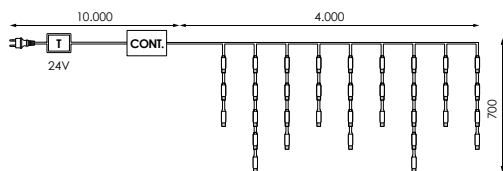



















# ICICLE Cascada

	24V
<b>Hz</b>	50-60Hz
	CIII
	4 CANALES
	IP44
	1,6kg (N.W.)
	INC.
	4ud (4m)
	2ud (6m)



Hotel Spa Relais & Chateaux a Quinta Da Agua  
Santiago de Compostela



	4x0,7m			
	32	087155		
	576	192217		
	12/24/16/20	087162		
<b>W</b>	33W			
	NO Empalmable			
	6x0,7m			
	48	087179		
	864	192224		
	12/24/16/20	087186		
<b>W</b>	40W			
	NO Empalmable			

Información/Information/Information/Informações

Ñ/ Controlador 8 funciones  
**INCLUIDO.**

E/ Controller 8 functions  
**IN-  
CLUDED.**

F/ Contrôleur 8 fonctions  
**INCLUS.**

P/ Controlador 8 funções  
**INCLUIDO.**





Cuidad Real



# Red 24V

## 2x1m Fuente Alimentación

	24V dc
<b>Hz</b>	50-60Hz
	CIII
	1 CANAL
	IP65
	-20°C~+60 °C
	1,6kg (N.W.)
	NO INC.
	10ud



Ciudad Real

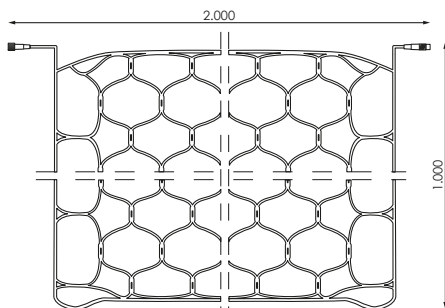

	2x1m
	98
<b>W</b>	5,5W
	Máx. 10 sets en serie

163194		
<b>N</b> 588898		

ESQUEMA INSTALACIÓN/  
INSTALLATION SCHEME/  
SCHEMA D'INSTALLATION/  
ESQUEMA DE  
INSTALAÇÃO



+ Producto/Product  
Produit/Produto

### Aviso/Warning/Avertissement/Aviso

**Ñ/** Uso **OBLIGATORIO** de fuente de alimentación.

**E/** You **MUST USE** the power supply.

**F/** L'utilisation **OBLIGATOIRE** du l'alimentation

**P/** Uso **OBRIGATÓRIO** fonte de alimentação.

### Accesorios (NO Incluidos) / Accessoires (NOT Included) / Accessories (NON Inclus)/ Acessórios (NÃO Incluso)

+ INFO PAG. 380

**Ñ/** Fuente de alimentación **NO INCLUIDA**

488440

Fuente alimentación 30W 24V

**E/** Power supply **NOT INCLUDED**

481687

Fuente alimentación 150W 24V

**F/** Alimentation **NON INCLUSE**

Fuente alimentación 150W 24V

**P/** Fonte de alimentação **NÃO INCLUIDO**

488457

Fuente alimentación 60W 24V

481694

Fuente alimentación 200W 24V

488464

Fuente alimentación 100W 24V

# Red

2x1m



SMART LINK

⚡ 230V dc

Hz 50-60Hz

□ CII

☺ 1 CANAL

⊙ IP65

🌡 -20°C~+60 °C

📊 1kg (N.W.)

✗ NO INC.

📦 10ud

Guadalupe  
Cáceres

192231		
192248		
192255		
192262		

	2x1m
	200
W	18W
	15sets

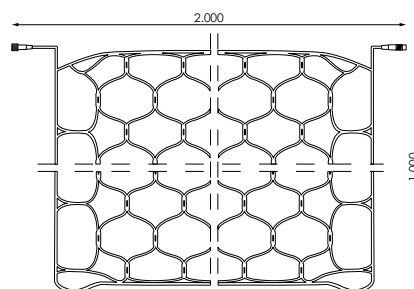

ESQUEMA INSTALACIÓN/  
INSTALLATION SCHEME/  
SCHEMA D'INSTALLATION/  
ESQUEMA DE  
INSTALAÇÃO



+

Producto/Product  
Produit/Produto

Accesorios (NO Incluidos) / Accessoires (NOT Included) / Accessories (NON Inclus) / Acessórios (NÃO Incluso)

+ INFO PAG. 380

995092

Cable alimentación Negro









977722

Cable alimentación Blanco

# Red

## 4x2m

SMART LINK 

	230V dc
<b>Hz</b>	50-60Hz
	CII
	1 CANAL
	IP65
	-20°C~+60 °C
	1,3kg (N.W.)
	NO INC.
	4ud





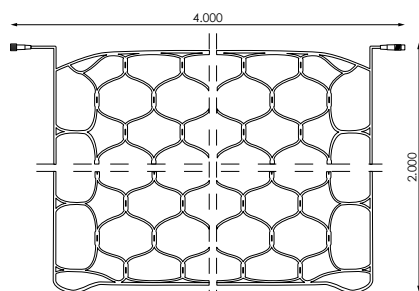











Guadalupe  
Cáceres



ESQUEMA INSTALACIÓN/  
INSTALLATION SCHEME/  
SCHEMA D'INSTALLATION/  
ESQUEMA DE  
INSTALAÇÃO



+ Producto/Product  
Produit/Produto

	4x2m			
	400	192279		
<b>W</b>	30W	192286		
	7sets	192293		
		192309		

Accesorios (NO Incluidos) / Accessoires (NOT Included) / Accessories (NON Inklus) / Acessórios (NÃO Includo)

+ INFO PAG. 380

995092

Cable alimentación Negro

977722

Cable alimentación Blanco



# Red

## 2x1m Flashing



SMART  
LINK

	230V dc
	50-60Hz
	CII
	1 CANAL
	IP65
	-20°C~+60 °C
	1kg (N.W.)
	NO INC.
	10ud

Cortijo MBI  
Sevilla



386081		
386098		

	2x1m
	170+30 flashing
	18W
	15sets

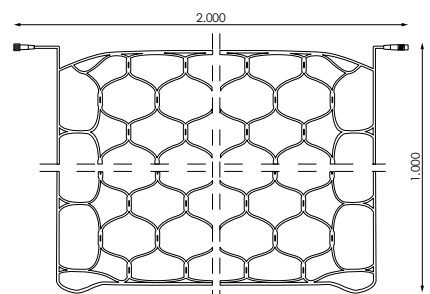

ESQUEMA INSTALACIÓN/  
INSTALLATION SCHEME/  
SCHÉMA D'INSTALLATION/  
ESQUEMA DE  
INSTALAÇÃO



Accesorios (NO Incluidos) / Accessoires (NOT Included) / Accessories (NON Inclus)/ Acessórios (NÃO Incluso)  
+ INFO PAG. 380









995092  
Cable alimentación Negro

977722  
Cable alimentación Blanco

# Red

## 4x2m Flashing

SMART  
LINK 

	230V dc
Hz	50-60Hz
	CII
	1 CANAL
	IP65
	-20°C~+60 °C
	1,3kg (N.W.)
	NO INC.
	4ud





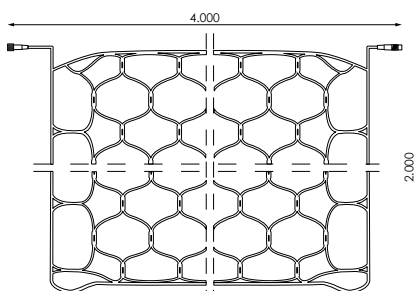







Viveiro  
Lugo



ESQUEMA INSTALACIÓN/  
INSTALLATION SCHEME/  
SCHEMA D'INSTALLATION/  
ESQUEMA DE  
INSTALAÇÃO



Producto/Product  
Produit/Produto

	4x2m			
	340+60 flashing	386104		
W	30W	386111		
	7sets			

Accesorios (NO Incluidos) / Accessoires (NOT Included) / Accessories (NON Inclus) / Acessórios (NÃO Incluso)

+ INFO PAG. 380

995092

Cable alimentación Negro

977722





Cable alimentación Blanco

# Accesorios (NO Incluidos)



Accessoires (NOT Included)

Accessories (NON Inclus)

Acessórios (NÃO Incluso)

		String AVANT 180 IP67 / String AVANT 180 IP67 Flashing	STRING PLUS 180 24V / STRING PLUS 180 24V Flashing	STRING PLUS 180 / STRING PLUS 180 Flashing	STRING PLUS 120 All Flashing	STRING PLUS 180 Sparkles	STRING PLUS 180 Dual	SCREENLIGHT 300 24V	SCREENLIGHT 600 24V	SCREENLIGHT / SCREENLIGHT Flashing	SCREENLIGHT All Flashing	SCREENLIGHT Dual	SCREENLIGHT 250 FALL LITE	Cluster Light Fall Lite	Cluster Light Flashing	Techo Luz SCREENLIGHT Flashing	ICICLE / ICICLE Flashing	Red 24V	Red / Red Flashing
	149181		•															•	
	149198		•															•	
	149204		•						•									•	
	149211		•						•									•	
	150323		•						•									•	
	192507									•	•				•		•		•
	192514									•	•				•		•		•
	193061												•	•					
	193078												•	•					
	364478		•						•									•	
	481687		•					•										•	
	481694		•					•										•	
	487207	•																	
	487214	•																	
	487474	•																	
	487581	•																	
	488440		•					•										•	
	488457		•					•										•	
	488464		•					•										•	
	977722			•	•	•				•	•				•		•		•
	995092			•	•	•				•	•				•		•		•
	391559						•					•							
	971072						•					•							
	192323			•	•	•				•	•		•	•	•	•	•		•
	192347			•	•	•				•	•		•	•	•	•	•		•
	192354			•	•	•				•	•		•	•	•	•	•		•
	192361			•	•	•				•	•		•	•	•	•	•		•
	192378			•	•	•				•	•		•	•	•	•	•		•
	192385			•	•	•				•	•		•	•	•	•	•		•
	192392			•	•	•				•	•		•	•	•	•	•		•
	192408			•	•	•				•	•		•	•	•	•	•		•
	192415			•	•	•				•	•		•	•	•	•	•		•
	192422			•	•	•				•	•		•	•	•	•	•		•
	192439			•	•	•				•	•		•	•	•	•	•		•
	192446			•	•	•				•	•		•	•	•	•	•		•
	192453			•	•	•				•	•		•	•	•	•	•		•
	192477			•	•	•				•	•		•	•	•	•	•		•
	192484			•	•	•				•	•		•	•	•	•	•		•



		String AVANT 180 IP67 / String AVANT 180 IP67 Flashing	STRING PLUS 180 24V / STRING PLUS 180 24V Flashing	STRING PLUS 180 / STRING PLUS 180 Flashing	STRING PLUS 120 All Flashing	STRING PLUS 180 Sparkles	STRING PLUS 180 Dual	SCREENLIGHT 300 24V	SCREENLIGHT 600 24V	SCREENLIGHT / SCREENLIGHT Flashing	SCREENLIGHT All Flashing	SCREENLIGHT Dual	SCREENLIGHT 250 FALL LITE	Cluster Light Fall Lite	Cluster Light Flashing	Techo Luz SCREENLIGHT Flashing	ICICLE / ICICLE Flashing	Red 24V	Red / Red Flashing
192491				•	•	•				•	•		•	•	•	•	•		•
388368				•	•	•				•	•		•	•	•	•	•		•
388375				•	•	•				•	•		•	•	•	•	•		•
388382				•	•	•				•	•		•	•	•	•	•		•
388399				•	•	•				•	•		•	•	•	•	•		•
388498				•	•	•				•	•		•	•	•	•	•		•
388504				•	•	•				•	•		•	•	•	•	•		•
391498				•	•	•				•	•		•	•	•	•	•		•
391504				•	•	•				•	•		•	•	•	•	•		•
391535			•				•	•	•			•						•	
481700			•				•	•	•			•						•	•
481717			•				•	•	•			•						•	•
481724			•				•	•	•			•						•	•
487221	•																		
487238	•																		
487245	•																		
487252	•																		
487269	•																		
 487276	•																		
487283	•																		
487344	•																		
487375	•																		
487382	•																		
487399	•																		
487405	•																		
487412	•																		
487429	•																		
487436	•																		
487443	•																		
487450	•																		
487467	•																		
553698	•	•	•	•	•	•	•	•	•	•	•	•	•	•	•	•	•	•	•
971140			•				•	•	•			•						•	•
971188			•				•	•	•			•						•	•
971195			•				•	•	•			•						•	•
971201			•				•	•	•			•						•	•
971218			•				•	•	•			•						•	•
 400794				•	•	•				•	•		•	•	•	•	•		•

### CABLE ALIMENTACIÓN AVANT

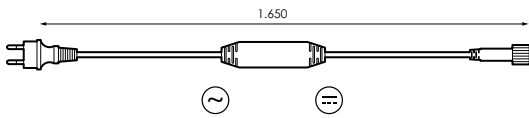

	Icon 1	Icon 2	Icon 3	Icon 4	Icon 5	Icon 6
487207				W		IP44 Plug IP67 Conector
487214				W		IP44 Plug IP67 Conector

### RECTIFICADOR AVANT

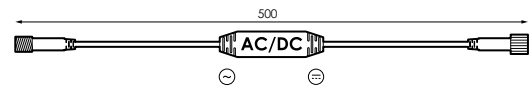

	Icon 1	Icon 2	Icon 3	Icon 4	Icon 5
487481				W	IP67
487474				W	IP67

### ADAPTADOR AVANT

#### SMART-FLEXILIGHT

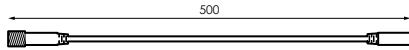

	Icon 1	Icon 2	Icon 3
487443			IP67
487436			IP67

Termoretractil y conector macho **NO INCLUIDOS**  
Heat-shrinkable and male connector **NOT INCLUDED**  
Thermorétractable et connecteur mâle **NON INCLUS**  
Tubo de contração térmica e conector macho **NÃO INCLUÍDO**

### ADAPTADOR AVANT

#### FLEXILIGHT-SMART

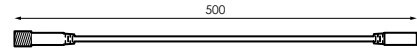

	Icon 1	Icon 2	Icon 3
487467			IP67
487450			IP67

Termoretractil y conector macho **NO INCLUIDOS**  
Heat-shrinkable and male connector **NOT INCLUDED**  
Thermorétractable et connecteur mâle **NON INCLUS**  
Tubo de contração térmica e conector macho **NÃO INCLUÍDO**

### EXTENSIÓN AVANT

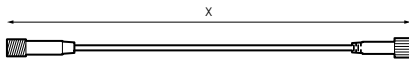

	Icon 1	Icon 2	Icon 3	Icon 4
487238				IP67
487221				IP67
487252				IP67
487245				IP67
487276				IP67
487269				IP67

### CONECTOR 5 AVANT

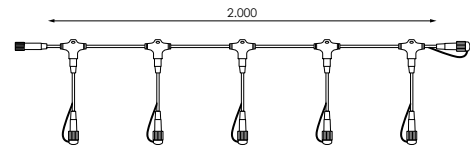

	Icon 1	Icon 2	Icon 3	Icon 4	Icon 5
487382					IP67
487375					IP67

### CONECTOR 10 AVANT

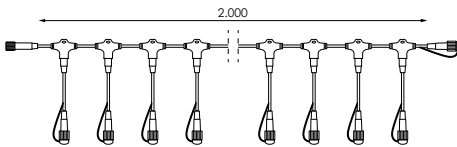

	Icon 1	Icon 2	Icon 3	Icon 4	Icon 5
487405					IP67
487399					IP67

### CONECTOR 10 AVANT

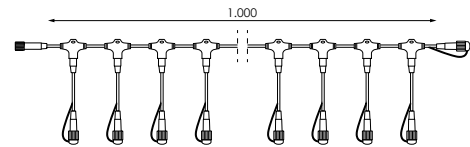

	Icon 1	Icon 2	Icon 3	Icon 4	Icon 5
487344					IP67
487283					IP67

CONECTOR T AVANT

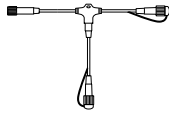

487429



IP67

487412



IP67

TRANSFORMADOR 24V

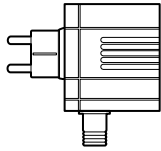

W

TR

149181

Máx. 10,8W

Sin rectificador  
Without rectifier  
Sans redresseur  
Sem retificador

TRANSFORMADOR 24V

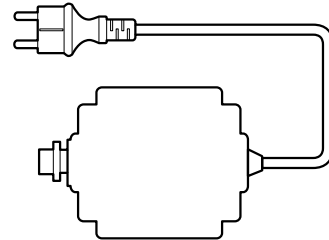

W

TR

149198

Máx. 28,8W

Sin rectificador  
Without rectifier  
Sans redresseur  
Sem retificador

TRANSFORMADOR 24V

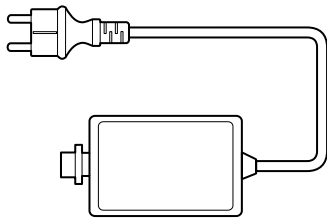

TR

149204

Max. 60W

Sin rectificador  
Without rectifier  
Sans redresseur  
Sem retificador

TRANSFORMADOR 24V

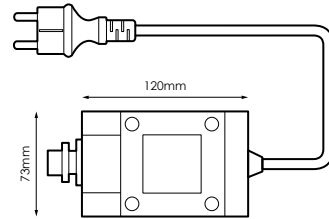

TR

149211

Max. 120W

Sin rectificador  
Without rectifier  
Sans redresseur  
Sem retificador

RECTIFICADOR 24V

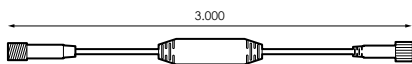

R

150323

3m

W

Max. 60W

364478

3m

Max. 90W

FUENTE ALIMENTACIÓN 24V

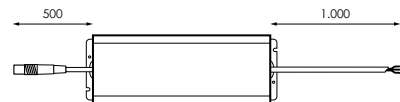

W



488440 170-240V 24V 30W IP66/ IP44 Plug 202 x 34 x 36mm 1 salida

488457 170-240V 24V 60W IP66/ IP44 Plug 197 x 45 x 32mm 1 salida

488464 170-240V 24V 100W IP66/ IP44 Plug 248 x 45 x 32mm 1 salida

481687 100-240V 24V 150W IP66/ IP44 Plug 230 x 63 x 39mm 1 salida

481694 100-240V 24V 200W IP66/ IP44 Plug 260 x 73 x 45mm 2 salidas



### CABLE ALIMENTACIÓN SMART LINK

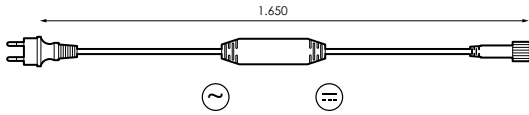

UR	995092		230Vac	Max. 480W	CII	IP44 Plug IP65 Conector
	977722		230Vac	Max. 480W	CII	IP44 Plug IP65 Conector

### CABLE ALIMENTACIÓN SMART LINK

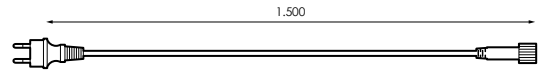

	193061		230Vac	Max. 480W	CII	IP44 Plug IP65 Conector
	193078		230Vac	Max. 480W	CII	IP44 Plug IP65 Conector

### RECTIFICADOR SMART LINK

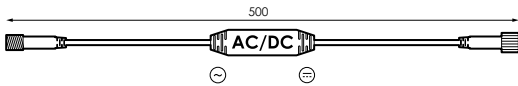

R	192514		Max. 460W	CII	IP65
	192507		Max. 460W	CII	IP65

### TAPA FINAL SMART LINK



400794	BI	Blanco
--------	----	--------

### EXTENSIÓN SMART LINK

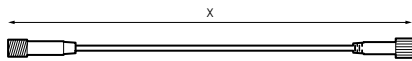

	↔		
388498	0,5m		IP65
388504	0,5m		IP65
192347	1m		IP65
192323	1m		IP65
192361	3m		IP65
192354	3m		IP65
192385	5m		IP65
192378	5m		IP65

### TERMORRETRACTIL

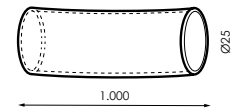

553698	Termorretractil Ø25mm, corte 1m. Heat-shrinkable Ø25mm, cut 1m. Ø25mm thermorétractable, couper 1m. Tubo contração térmica Ø25mm, corte 1m.
972451	Pistola aire caliente profesional 2000W Hot air gun professional 2000W Pistolet à air chaud 2000W professionnel Soprador de ar quente 2000W profissional

### ADAPTADOR SMART LINK

#### SMART-FLEXILIGHT

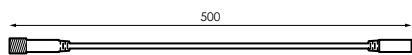

A	192477		IP65
	192453		IP65

### ADAPTADOR SMART LINK

#### FLEXILIGHT-SMART

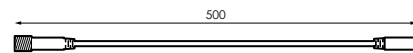

A	192491		IP65
	192484		IP65

Termorretractil y conector macho **NO INCLUIDOS**  
Heat-shrinkable and male connector **NOT INCLUDED**  
Thermorétractable et connecteur mâle **NON INCLUS**  
Tubo de contração térmica e conector macho **NÃO INCLUIDO**

Termorretractil y conector macho **NO INCLUIDOS**  
Heat-shrinkable and male connector **NOT INCLUDED**  
Thermorétractable et connecteur mâle **NON INCLUS**  
Tubo de contração térmica e conector macho **NÃO INCLUIDO**

CONECTOR T SMART LINK

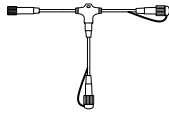

192446



IP65

192439



IP65

CONECTOR X SMART LINK

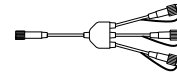

391504



IP65

391498



IP65

CONECTOR 5 SMART LINK

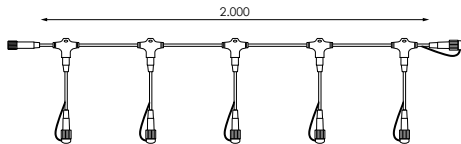

388375

2m

5



IP65

388368

2m

5



IP65

CONECTOR 10 SMART LINK

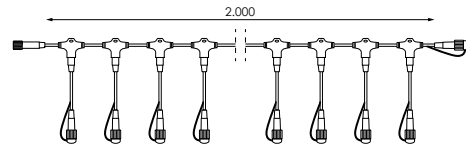

388399

2m

10



IP65

388382

2m

10



IP65

CONECTOR 10 SMART LINK

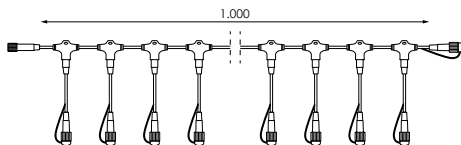

192408

1m

10



IP65

192392

1m

10



IP65

CONECTOR 20 SMART LINK

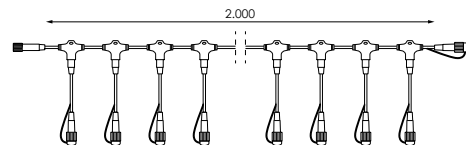

192422

2m

20



IP65

192415

2m

20



IP65

CONTROLADOR DUAL

2A

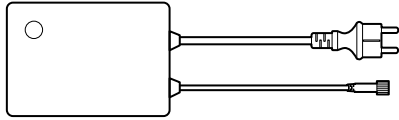

391559



230V

W

Max. 240W

8 funciones efecto memoria  
8 functions memory effect  
8 fonctions effet mémoire  
8 funções efeito de memória

CONTROLADOR DUAL

6A

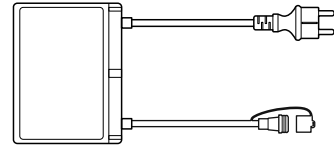

971072



230V

W

Max. 1.200W



\*Max. 240m

\*Máx. 240m (máx. 90m por salida)/ 4 funciones  
\*Max. 240m (max. 90m per output)/ 4 functions  
\*Max. 240m (max. 90m par sortie)/ 4 fonctions  
\*Max. 240m (max. 90m por saída)/ 4 funções

EXTENSIÓN DUAL/24V

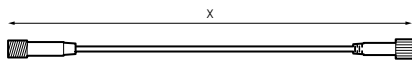

391535

0,5m



481724

1m



971188

3m



971140

5m



588911

0,5m



588928

1m



588935

3m



588942

5m



CONECTOR DUAL/24V

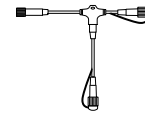

971218

Conector T  
Connector T  
Connecteur en T  
Conector em T

CONECTOR 10 DUAL/24V

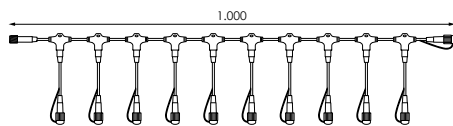

971195

1m

10

CONECTOR 5 DUAL/24V

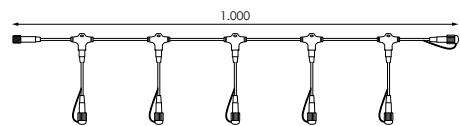

971201

1m

5

CONECTOR 10 DUAL/24V

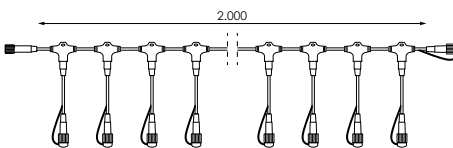

481700

2m

10



IP44

CONECTOR 20 DUAL/24V

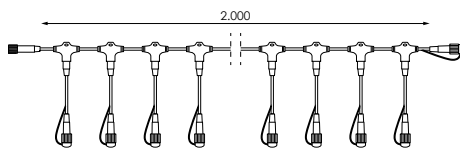

481717

2m

20



IP44











# Led Interior

Indoors Led  
Led à l'intérieur  
Led Interior

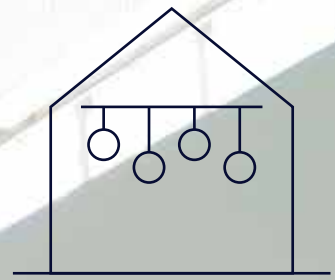















# flexiLIGHT LED

Ø7mm





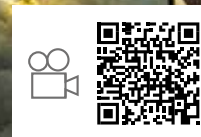



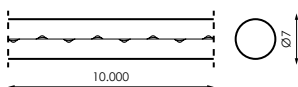







	6V
<b>Hz</b>	50-60Hz
	CIII
	1 CANAL/ 2 VÍAS
	IP44
	360°
	-20°C~+60 °C
	INC.
	Rollo 10m

**Ñ/** \*Con movimiento.  
**E/** \*With movement.  
**F/** \*Avec mouvement.  
**P/** \*Com movimento.



[GRÁFICOS: Unidades en mm/ GRÁFICOS: Units in mm/GRAPHIQUES: Unités en mm/GRÁFICOS: Unidades em mm]



	7mm			
	20	192521		
<b>W</b>	6W	192538		
	NO Empalmable	192545		
	Rollo 10m	192552		
		192569*		

Aviso/Warning/Avertissement/Aviso

**Ñ/** Transformador **INCLUIDO.**

**E/** Transformer **INCLUDED.**

**F/** Transformateur **INCLUS.**

**P/** Transformador **INCLUÍDO.**

# STRING **PLUS** 180



SMART  
LINK 



 230V dc

Hz 50-60Hz

 CII

 1 CANAL













 IP20







 -20°C~+60 °C

 0,9kg (N.W.)

 NO INC.

 10ud

		
192576		
192583		
405874		
405850		
405867		

	12m (4m x 3seg)
	4m
	180
	60
W	10W
	3,5W
	100m

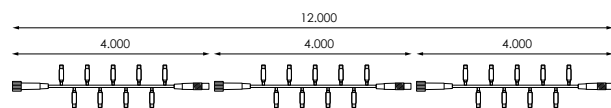

ESQUEMA INSTALACIÓN/  
INSTALLATION SCHEME/  
SCHÉMA D'INSTALLATION/  
ESQUEMA DE  
INSTALAÇÃO



+

Producto/Product  
Produit/Produto

Accesorios (NO Incluidos) / Accessoires (NOT Included) / Accessories (NON Inclus) / Acessórios (NÃO Incluso)

+ INFO PAG. 400

192606

Cable alimentación Transparente



# STRING **PLUS** 180

## Flashing

	230V dc
<b>Hz</b>	50-60Hz
	CII
	1 CANAL
	IP20
	-20°C~+60 °C
	1,15kg (N.W.)
	NO INC.
	10ud



CC. Nervión Plaza  
Sevilla

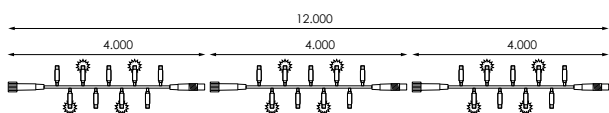

ESQUEMA INSTALACIÓN/  
INSTALLATION SCHEME/  
SCHEMA D'INSTALLATION/  
ESQUEMA DE  
INSTALAÇÃO



Producto/Product  
Produit/Produto

	12m (4m x 3seg)
	4m
	180
	50+10 flashing
<b>W</b>	10W
	3,5W
	100m

413756		
413763		

Accesorios (NO Incluidos) / Accessoires (NOT Included) / Accessories (NON Inclus) / Acessórios (NÃO Incluso)

+ INFO PAG. 400

192606

Cable alimentación Transparente

# Cluster Light

## Fall Lite 3m



	230V
<b>Hz</b>	50-60Hz
	CII
	IP20
	-20°C~+60 °C
	1,4kg (N.W.)
	NO INC.
	INC.
	10ud



				3m
388269				6cm
388276				150
			<b>W</b>	3,5W
				NO Empalmable

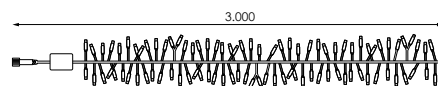

ESQUEMA INSTALACIÓN/  
INSTALLATION SCHEME/  
SCHEMA D'INSTALLATION/  
ESQUEMA DE  
INSTALAÇÃO



+

Producto/Product  
Produit/Produto

Accesorios (NO Incluidos) / Accessoires (NOT Included) / Accessories (NON Inclus) / Acessórios (NÃO Incluso)

+ INFO PAG. 400

193061  
Cable alimentación Negro

193078  
Cable alimentación Blanco

# Cluster Light

## Fall Lite 5m

SMART  
LINK 

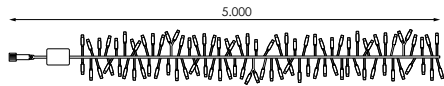









ESQUEMA INSTALACIÓN/  
INSTALLATION SCHEME/  
SCHEMA D'INSTALLATION/  
ESQUEMA DE  
INSTALAÇÃO



+

Producto/Product  
Produit/Produto

	5m			
	6cm	388290		
	250			
W	7W			
	NO Empalmable			

Accesorios (NO Incluidos) / Accessoires (NOT Included) / Accessories (NON Inclus)/ Acessórios (NÃO Incluso)

+ INFO PAG. 400

193061

Cable alimentación Negro

193078

Cable alimentación Blanco

# Cluster Light

## Fall Lite 10m

SMART  
LINK 













ESQUEMA INSTALACIÓN/  
INSTALLATION SCHEME/  
SCHEMA D'INSTALLATION/  
ESQUEMA DE  
INSTALAÇÃO



+

Producto/Product  
Produit/Produto

	10m			
	6cm	388306		
	500	388313		
W	12W			
	NO Empalmable			

Accesorios (NO Incluidos) / Accessoires (NOT Included) / Accessories (NON Inclus)/ Acessórios (NÃO Incluso)

+ INFO PAG. 400

193061

Cable alimentación Negro

193078









Cable alimentación Blanco



















# SCREENLIGHT 300

Flashing



	230V dc
Hz	50-60Hz
	CII
	1 CANAL
	IP20
	-20°C~+60 °C
	3kg (N.W.)
	NO INC.
	5ud

		
388320	   	
388337	   	

	2x1,5m
	20 (2 tiras = 1 serie)
	300
	13+2 flashing
W	31W
	10sets

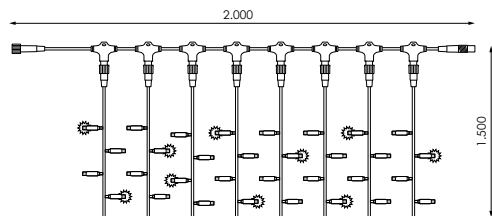

ESQUEMA INSTALACIÓN/  
INSTALLATION SCHEME/  
SCHEMA D'INSTALLATION/  
ESQUEMA DE  
INSTALAÇÃO



+

Producto/Product  
Produit/Produto

Accesorios (NO Incluidos) / Accessoires (NOT Included) / Accessories (NON Inclus) / Acessórios (NÃO Incluso)









+ INFO PAG. 400

192606

Cable alimentación Transparente

# SCREENLIGHT 600

Flashing

	230V dc
<b>Hz</b>	50-60Hz
	CII
	1 CANAL
	IP20
	-20°C~+60 °C
	4,7kg (N.W.)
	NO INC.
	2ud





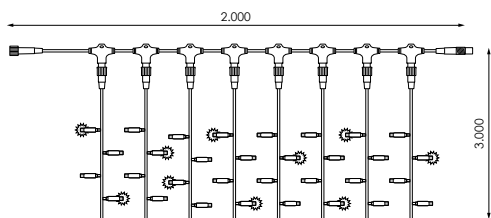

[GRÁFICOS: Unidades en mm/ GRÁFICOS: Units in mm/ GRAPHICS: Units in mm/ GRÁFICOS: Unidades em mm]









ESQUEMA INSTALACIÓN/  
INSTALLATION SCHEME/  
SCHEMA D'INSTALLATION/  
ESQUEMA DE  
INSTALAÇÃO



+ Producto/Product  
Produit/Produto

	2x3m
	20 (2 tiras = 1 serie)
	600
	26+4 flashing
<b>W</b>	38,5W
	7sets

		
441674		
441681		

Accesorios (NO Incluidos) / Accessoires (NOT Included) / Accessories (NON Inclus)/ Acessórios (NÃO Incluso)

+ INFO PAG. 400

192606

Cable alimentación Transparente

# ICICLE: 114



	230V dc
<b>Hz</b>	50-60Hz
	CII
	1 CANAL
	IP20
	-20°C~+60 °C
	1kg (N.W.)
	NO INC.
	10ud

192637		
546553		
546560		

	3x0,5m (1,5m x 2seg)
	Nº 2
	114
	57
<b>W</b>	8,2W
	20sets

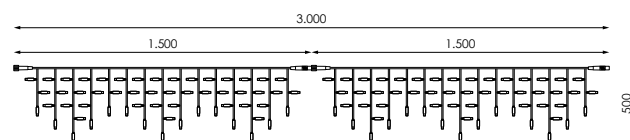

ESQUEMA INSTALACIÓN/  
INSTALLATION SCHEME/  
SCHEMA D'INSTALLATION/  
ESQUEMA DE  
INSTALAÇÃO



+

Producto/Product  
Produit/Produto









Accesorios (NO Incluidos) / Accessoires (NOT Included) / Accessories (NON Inclus) / Acessórios (NÃO Incluso)

+ INFO PAG. 400

192606

Cable alimentación Transparente



	230V dc
<b>Hz</b>	50-60Hz
	CII
	1 CANAL
	IP20
	-20°C~+60 °C
	1,7kg (N.W.)
	NO INC.
	10ud





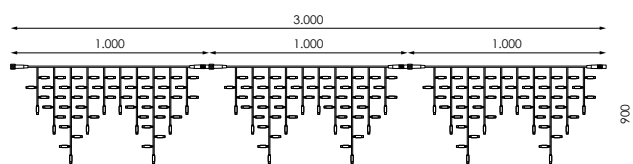

[GRÁFICOS: Unidades en mm/ GRÁFICOS: Units in mm/ GRAPHICS: Units in mm/ GRÁFICOS: Unidades em mm]









ESQUEMA INSTALACIÓN/  
INSTALLATION SCHEME/  
SCHEMA D'INSTALLATION/  
ESQUEMA DE  
INSTALAÇÃO



+ Producto/Product  
Produit/Produto

	3x0,9m (1m x 3seg)
	3
	174
	58
<b>W</b>	11,6W
	15sets

		
192644		
192651		

Accesorios (NO Incluidos) / Accessoires (NOT Included) / Accessories (NON Includo) / Acessórios (NÃO Includo)

+ INFO PAG. 400

192606

Cable alimentación Transparente

# Accesorios (NO Incluidos)

Accessoires (NOT Included)

Accessories (NON Inclus)

Acessórios (NÃO Incluso)

		STRING <b>PLUS</b> 180	STRING <b>PLUS</b> 180 FLASHING	Cluster Light FALL LITE	SCREENLIGHT FLASHING	ICICLE#
⏏	192606	•	•		•	•
	193061			•		
	193078			•		
Ⓢ	192323			•		
	192347			•		
	192354			•		
	192361			•		
	192378			•		
	192385			•		
	192392			•		
	192408			•		
	192415			•		
	192422			•		
	192439			•		
	192446			•		
	388368			•		
	388375			•		
	388382			•		
	388399			•		
	388498			•		
	388504			•		
	391498			•		
	391504			•		

CABLE ALIMENTACIÓN SMART LINK

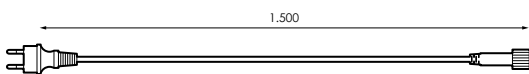

CABLE ALIMENTACIÓN SMART LINK

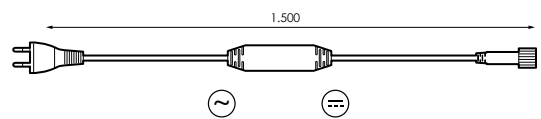

⏏		∞	⚡	W	□	⦿
193061			230Vac	Max. 480W	CII	IP44 Plug IP65 Conector
193078			230Vac	Max. 480W	CII	IP44 Plug IP65 Conector

⏏		∞	⚡	W	□	⦿
192606			230Vac	Max. 480W	CII	IP20

### CONECTOR T SMART LINK

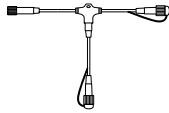

192446		IP65
192439		IP65

### CONECTOR X SMART LINK

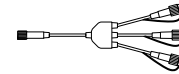

391504		IP65
391498		IP65

### CONECTOR 5 SMART LINK

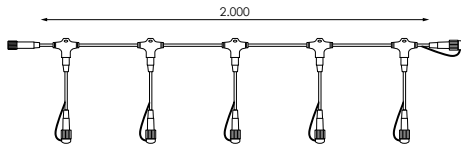

388375	2m	5		IP65
388368	2m	5		IP65

### CONECTOR 10 SMART LINK

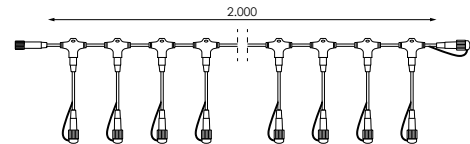

388399	2m	10		IP65
388382	2m	10		IP65

### CONECTOR 10 SMART LINK

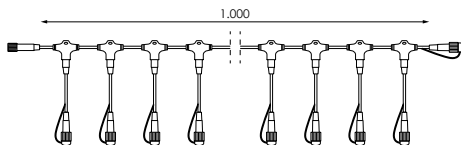

192408	1m	10		IP65
192392	1m	10		IP65

### CONECTOR 20 SMART LINK

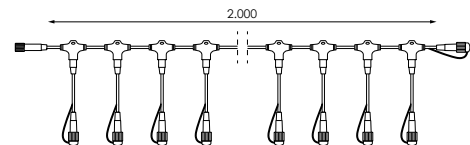

192422	2m	20		IP65
192415	2m	20		IP65

### EXTENSIÓN SMART LINK

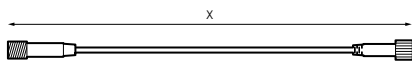

388498	0,5m		IP65
388504	0,5m		IP65
192347	1m		IP65
192323	1m		IP65
192361	3m		IP65
192354	3m		IP65
192385	5m		IP65
192378	5m		IP65







deco





# Cluster

## Microled



	6V
	50-60Hz
	CIII
	IP20
	-20°C~+60 °C
	INC.
	20ud

444354		

	2m
	280
	5W
	NO Empalmable

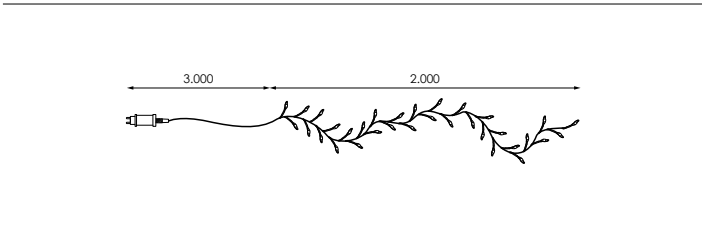





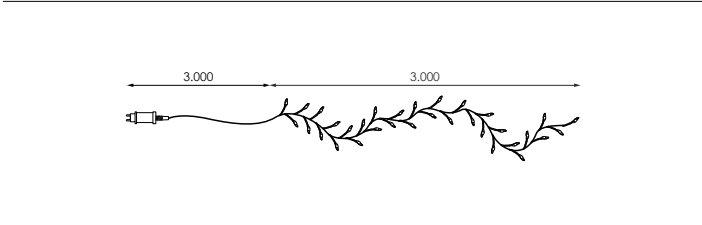

444361		

	3m
	420
	6W
	NO Empalmable





	24V
<b>Hz</b>	50-60Hz
	CIII
	IP20
	-20°C~+60 °C
	NO INC.
	NO INC.
	20ud

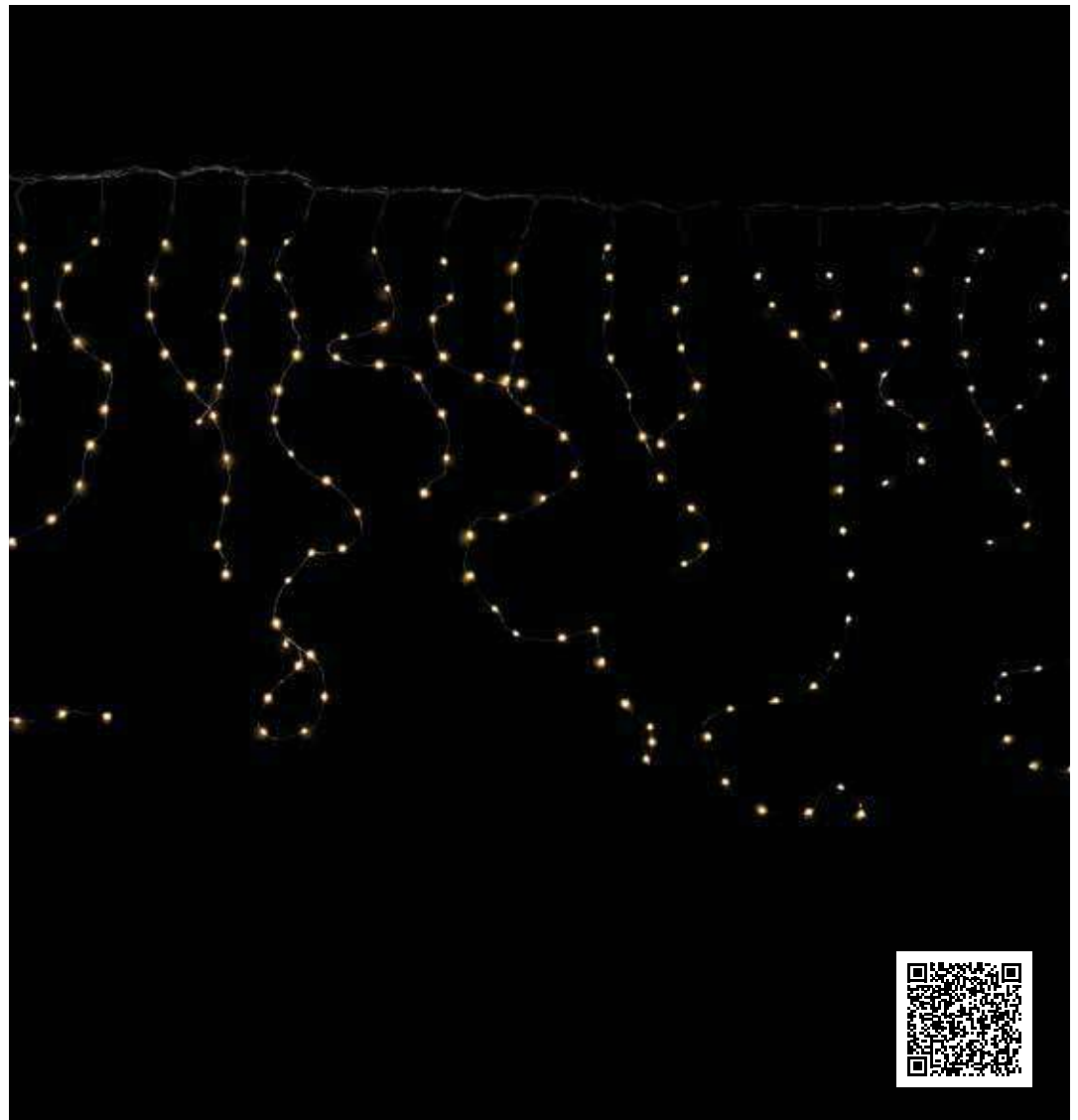



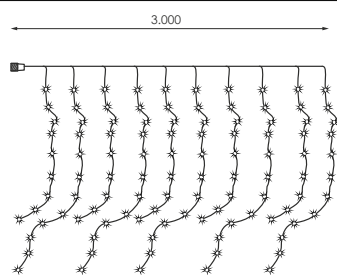

[GRÁFICOS: Unidades en mm/ GRÁFICOS: Units in mm/ GRAPHICS: Units in mm/ GRÁFICOS: Unidades em mm]



ESQUEMA INSTALACIÓN/  
INSTALLATION SCHEME/  
SCHEMA D'INSTALLATION/  
ESQUEMA DE  
INSTALAÇÃO



	3x1m
	360
<b>W</b>	6W
	4sets

		
444439		

### ACCESORIOS / ACCESSOIRES / ACCESSORIES / ACESSÓRIOS

+ INFO PAG. 468

444446

Transformador 25W

447720

Extensión

# Branch Tree



⚡	6V
Hz	50-60Hz
◇	CIII
⊙	IP20
🌡️	-20°C~+60 °C
TR	INC.
🔌	10ud





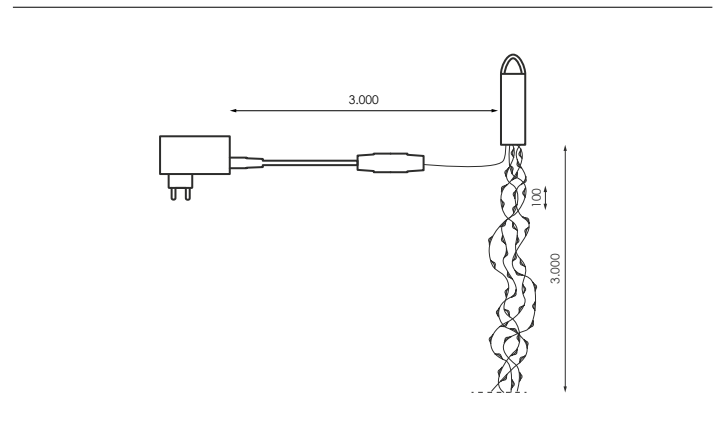

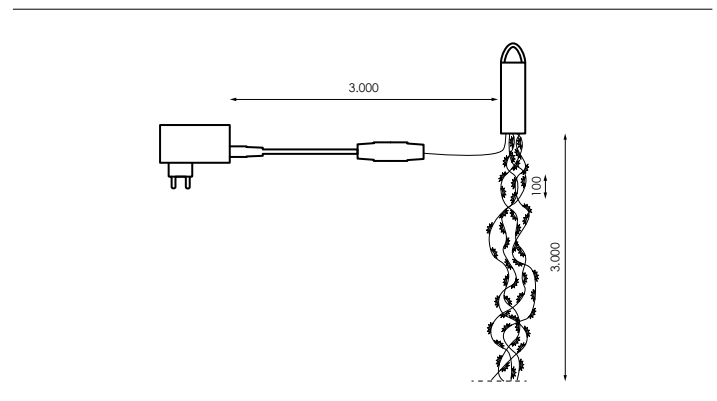

	💡	⊙	↔	3m
192767	LED	👁️	🔗	10
192781	LED	👁️	💡	300
			W	6W
			✖	NO Empalmable



	💡	⊙	↔	3m
192798	LED	👁️	🔗	10
			💡	300 flashing
			W	6W
			✖	NO Empalmable







# Branch String



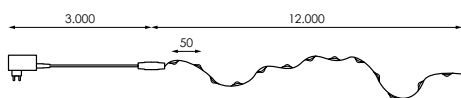

	6V
<b>Hz</b>	50-60Hz
	CIII
	IP20
	-20°C~+60 °C
	INC.
	10ud



[GRÁFICOS: Unidades en mm/ GRAPHICS: Units in mm/GRAPHIQUES: Unités en mm/GRÁFICOS: Unidades em mm]



	12m
	300
<b>W</b>	6W
	NO Empalmable

		
192705		



# Solar String



◊ CIII

°° IP44

⊕ 10ud

Ñ/ 2 Funciones: **Fija y flashing.**  
 E/ 2 Functions: **Fixed and flashing.**  
 F/ 2 Fonctions: **Fixes et clignotants.**  
 P/ 2 Funções: **Fixos e intermitentes.**

391177		
391160		

	12m
	0,24W 2V/120mA
	1,2V/600mA
	8h/carga
	NO Empalmable

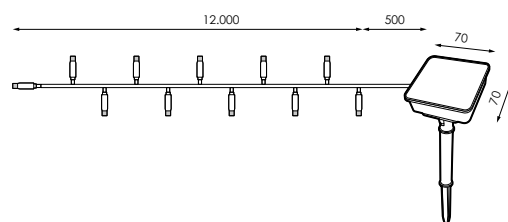

# LED Fireworks

	24V
	50-60Hz
	CIII
	IP44
	-20°C~+60 °C
	INC. 3m
	10ud



Canarias

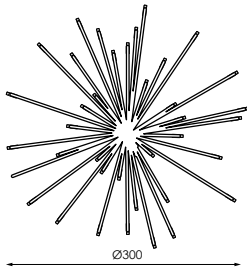

	Ø30cm
	80
	6,7W
	NO Empalmable

240789		

Transformador **INCLUIDO**  
Transformer **INCLUDED**  
Transformateur **INCLUS**  
Transformador **INCLUIDO**

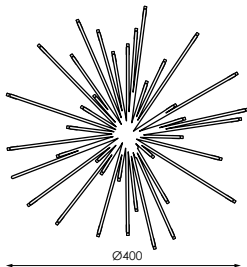

	Ø40cm
	120
	11W
	NO Empalmable

240796		
441759		
441780		
441810		

Transformador **INCLUIDO**  
Transformer **INCLUDED**  
Transformateur **INCLUS**  
Transformador **INCLUIDO**

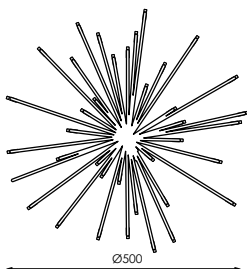

	Ø50cm
	240
	21,5W
	NO Empalmable

441735		
441766		
441797		
441827		

Transformador **INCLUIDO**  
Transformer **INCLUDED**  
Transformateur **INCLUS**  
Transformador **INCLUIDO**

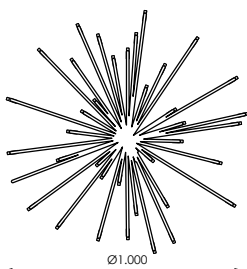





	Ø100cm
	480
	31,4W
	NO Empalmable

441742		
441773		
441803		
441834		

Transformador **INCLUIDO**  
Transformer **INCLUDED**  
Transformateur **INCLUS**  
Transformador **INCLUIDO**





**Hasta 3 años de garantía.**  
 Ver condiciones de uso  
**Up to 3 years of warranty**  
 See terms of use  
**Jusqu'à 3 ans de garantie**  
 Voir condition d'utilisation  
**Alé 3 anos de garantia**  
 Ver condições de uso

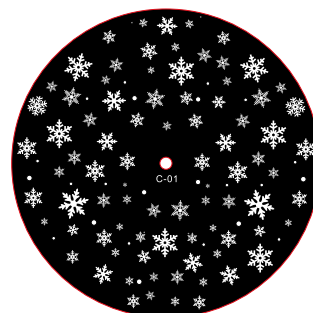

	100-240V
<b>Hz</b>	50-60Hz
	CII
	IP44 (Area Ventilador)
	IP65 (Proyector)
	INC.
	2ud

Fotolito de Serie



	W		$\phi$	$\Delta$
548335	60W		3.000lm	22°
548342	100W		7.000lm	22°

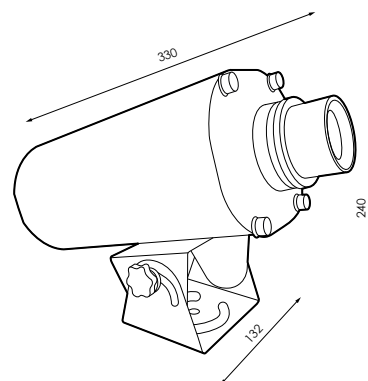
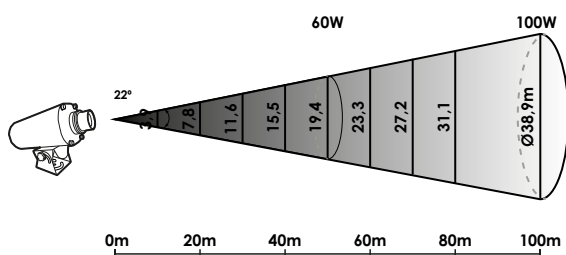



Diatancia (m)	Nesso 60W 22°	Nesso 100W 22°
1m	7.150Klux	15.800Klux
2m	1.780Klux	3.550Klux
3m	800Klux	1.600Klux
4m	465Klux	900Klux
5m	270Klux	560Klux
6m	170Klux	380Klux
7m	130Klux	270Klux
8m	100Klux	200Klux
9m	75Klux	160Klux
10m	60Klux	125Klux
11m	45Klux	100Klux
12m	35Klux	80Klux

Accesorios (NO Incluidos) / Accessoires (NOT Included) / Accessories (NON Inclus) / Acessórios (NÃO Incluso)

N 600002

Fotolito Muñeco Nieve Color



N 600033

Fotolito Muñeco Nieve B/N



N 599993

Fotolito Jengibre Color



N 600026

Fotolito Jengibre B/N

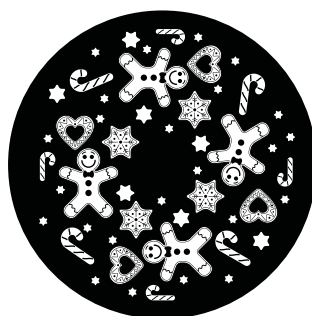

N 600019

Fotolito Papa Noel Color



N 600040

Fotolito Papa Noel B/N

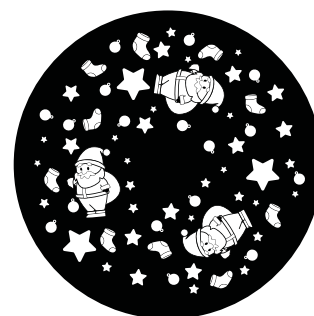

Aviso/Warning/Avertissement/Aviso

**Ñ/** Pérdida del efecto luminoso por contaminación lumínica.

**E/** Loss of the luminous effect due to light pollution.

**F/** Perte de l'effet lumineux dû à la pollution lumineuse.

**P/** Perda do efeito luminoso devido à poluição luminosa.

Información/Information/Information/Informações

**Ñ/** Posibilidad de diseño a medida en la proyección bajo consulta.

**E/** Possibility of custom design in the projection on request.

**F/** Possibilité de conception personnalisée dans la projection sur demande.

**P/** Possibilidade de design personalizado na projeção a pedido.

# Nesso

## Steady

Hasta 3 años de garantía.  
Ver condiciones de uso  
**Up to 3 years of warranty**  
See terms of use  
**Jusqu'à 3 ans de garantie**  
Voir condition d'utilisation  
**Alé 3 anos de garantia**  
Ver condições de uso



⚡ 230V

Hz 50-60Hz

☐ CII

⊙ IP44 (Area Ventilador)

⊙ IP65 (Proyector)

TR INC.

📦 2ud



Fotolito de Serie



Barcode	W	LED	φ	∠
513272	60W	LED	3.000lm	20°
N 599924	100W	LED	7.000lm	20°

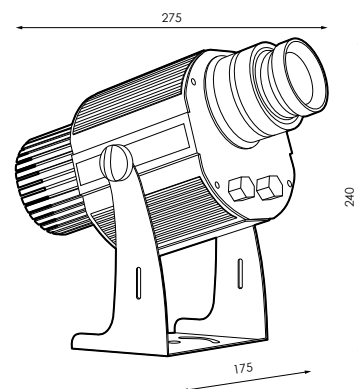
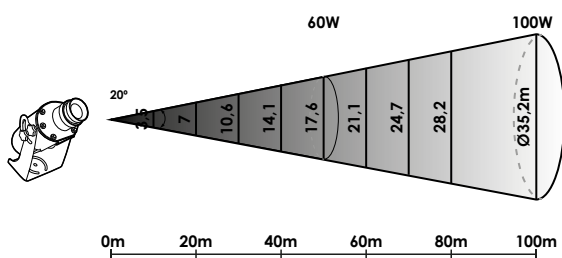

Diatancia (m)	Nesso Steady 60W 20°	Nesso Steady 100W 20°
1m	10.760Klux	18.790Klux
2m	2.600Klux	4.500Klux
3m	1.150Klux	2.100Klux
4m	670Klux	1.170Klux
5m	410Klux	740Klux
6m	270Klux	490Klux
7m	190Klux	360Klux
8m	150Klux	320Klux
9m	115Klux	210Klux
10m	90Klux	170Klux
11m	70Klux	140Klux
12m	65Klux	120Klux

Accesorios (NO Incluidos) / Accessoires (NOT Included) / Accessories (NON Inclus) / Acessórios (NÃO Incluso)

N 599948

Fotolito Muñeco Nieve Color



N 599931

Fotolito Jengibre Color



N 599955

Fotolito Papa Noel Color



N 599979

Fotolito Muñeco Nieve B/N



N 599962

Fotolito Jengibre B/N



N 599986

Fotolito Papa Noel B/N



Aviso/Warning/Avertissement/Aviso

**Ñ/** Pérdida del efecto luminoso por contaminación lumínica.

**E/** Loss of the luminous effect due to light pollution.

**F/** Perte de l'effet lumineux dû à la pollution lumineuse.

**P/** Perda do efeito luminoso devido à poluição luminosa.

Información/Information/Information/Informações

**Ñ/** Posibilidad de diseño a medida en la proyección bajo consulta.

**E/** Possibility of custom design in the projection on request.

**F/** Possibilité de conception personnalisée dans la projection sur demande.

**P/** Possibilidade de design personalizado na projeção a pedido.



# Giro Snowflake



⚡ 12V

Hz 50-60Hz

◇ CIII

° IP67

TR INC. 5m

12ud

**Ñ/ Recomendable** para distancias a pared que no excedan los **8m**.  
**E/ Suitable** for wall distances not exceeding **8m**.  
**F/ Convient** pour des distances de paroi ne dépassant pas **8m**.  
**P/ Adequado** para distâncias de parede não superior a **8m**.



Fundació Catalonia  
 San Cugat del Vallés



W

8W

392129

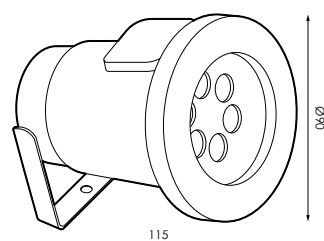

# Retail

Magnetismo Visual



En Prilux somos especialistas en la decoración e iluminación de espacios RETAIL como escaparates, tiendas, sets, corners... que convierte tu negocio en el foco de todas las miradas.

At Prilux we are specialists in the decoration and lighting of RETAIL spaces such as shop windows, shops, sets, corners ... that turns your business into the focus of all eyes.

A Prilux nous sommes spécialisés dans la décoration et l'éclairage des espaces RETAIL tels que: les vitrines des magasins, des magasins, des ensembles, des coins ... qui transforme votre entreprise dans le foyer de tous les yeux.

No Prilux somos especialistas na decoração e iluminação de espaços RETAIL: como vitrines, lojas, jogos, cantos ... que transforma o seu negócio para o foco de todas as atenções.

# Willow Light

1m

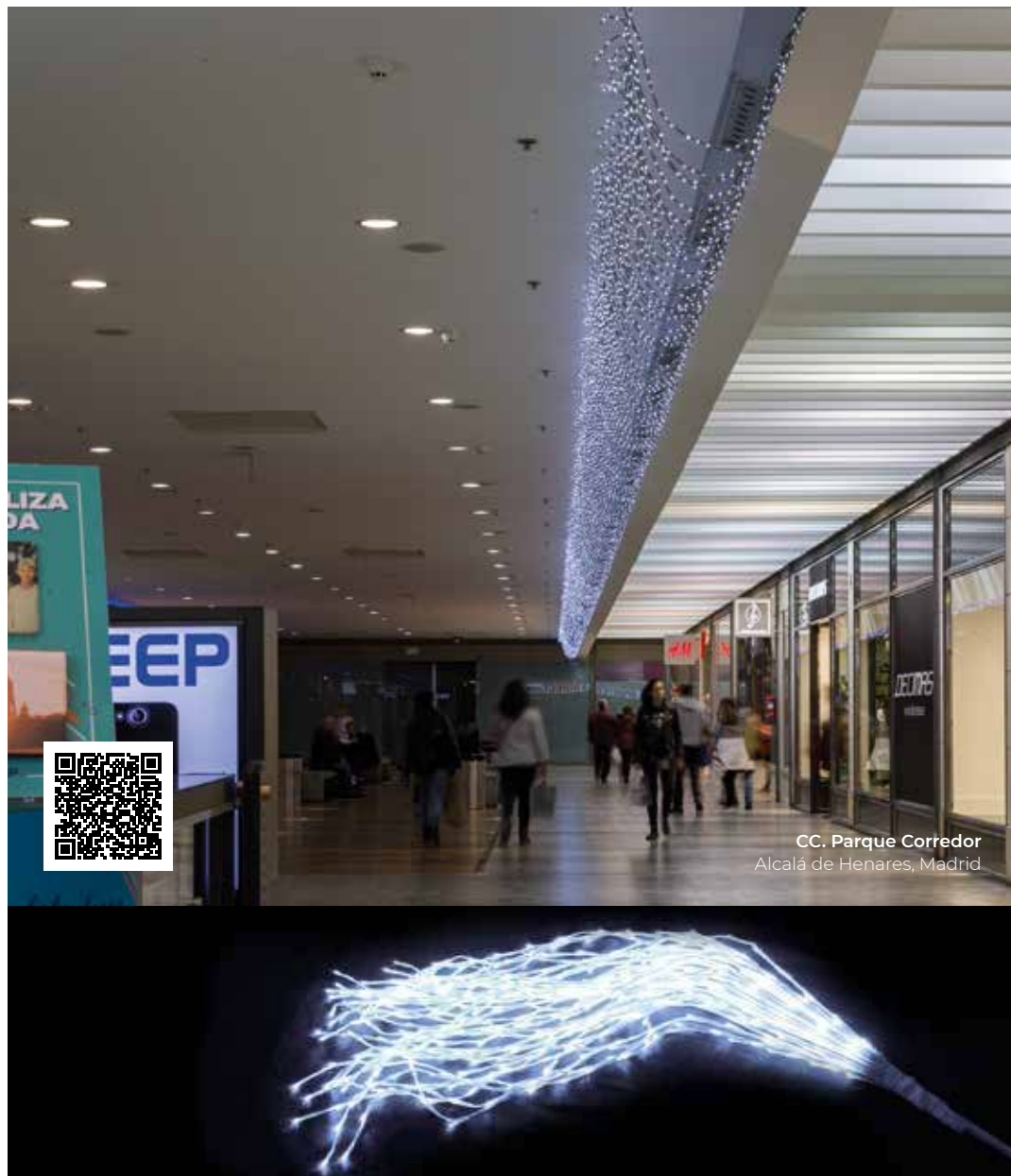

⚡ 24V

Hz 50-60Hz

◇ CIII

⊙ IP44

TR INC. 6,2m

3ud (1m)

⊕ 2ud (1,8m)

1ud (3m)

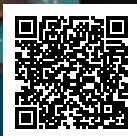

CC. Parque Corredor  
Alcalá de Henares, Madrid



391399		
391405		

	1m
	40
	640
W	59,3W
	NO Empalmable

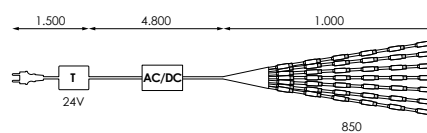

Accesorios (NO Incluidos) / Accessoires (NOT Included) / Accessories (NON Inclus) / Acessórios (NÃO Incluso)

+ INFO PAG. 468

401388

Soporte de pared



# Willow Light

1,8m

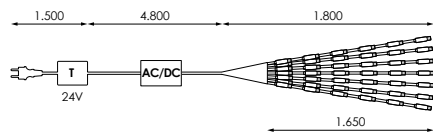
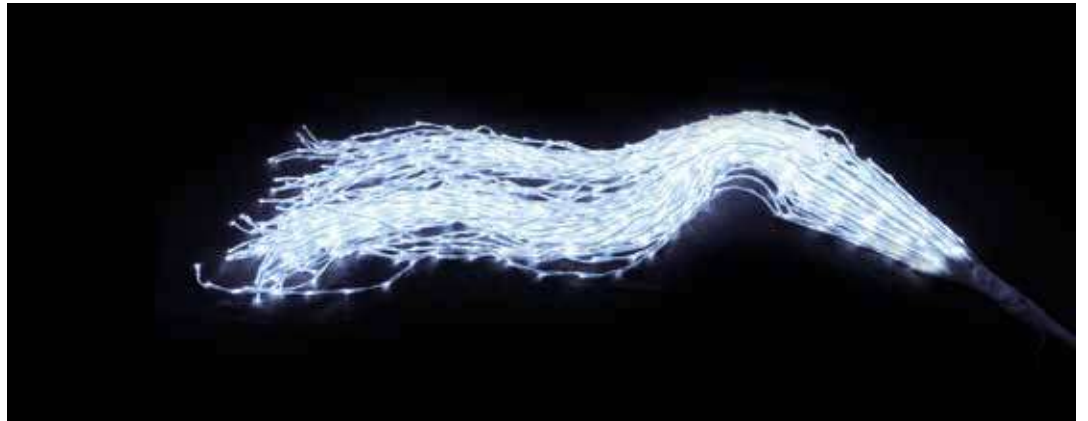

↔	1,8m		💡	∞
🔗	40	391412	LED	👁️
💡	1.280	391429	LED	👁️
W	77,7W			
🚫	NO Empalmable			

# Willow Light

3m

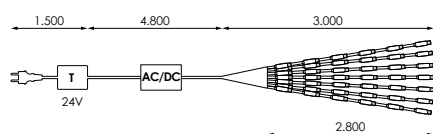
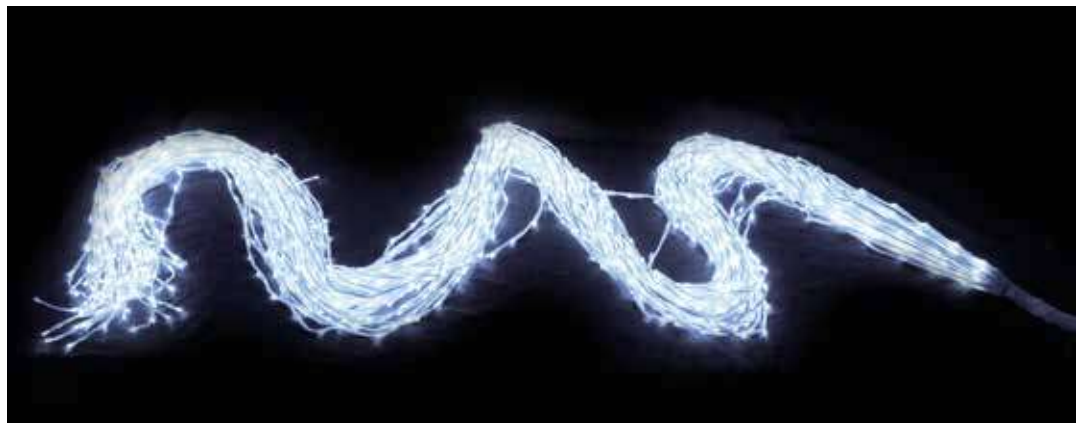

↔	3m		💡	∞
🔗	40	391443	LED	👁️
💡	2.240			
W	90,1W			
🚫	NO Empalmable			

# LED Fountain



⚡ 24V

Hz 50-60Hz

◇ CIII

° IP44

TR INC.

⊞ 1ud

Ñ/ Transformador efecto cascada **INCLUIDO** (4 velocidades y fijo).

E/ Transformer waterfall effect **INCLUDED** (4-speed and fixed).

F/ Transformateur cascade d'effet **INCLUS** (4 vitesses et une fixe).

P/ Transformador cachoeira de efeito **INCLUIDO** (4-speed e fixo).



	💡	⊞
192811	LED	📍
192828	LED	📍

↔	1,5m
⊘	Ø70cm
💡	1584
W	42,96W
✂	NO Empalmable

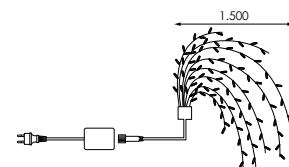

Accesorios (NO Incluidos) / Accessoires (NOT Included) / Accessories (NON Inclus) / Acessórios (NÃO Incluso)

+ INFO PAG. 468

401371

Soporte de pared

# Deco Branch

⚡ 24V

Hz 50-60Hz

⚡ CIII

☉ IP44

Ⓜ INC.

📦 1ud

Ñ/ Posibilidad de separar la rama en 2 partes.  
 E/ Possibility of separating the branch into 2 parts.  
 F/ Possibilité de séparer la branche en 2 parties.  
 P/ Possibilidade de separar a filial em 2 partes.



[GRÁFICOS: Unidades en mm/ GRÁFICOS: Units in mm/GRAPHIQUES: Unités en mm/GRÁFICOS: Unidades em mm]

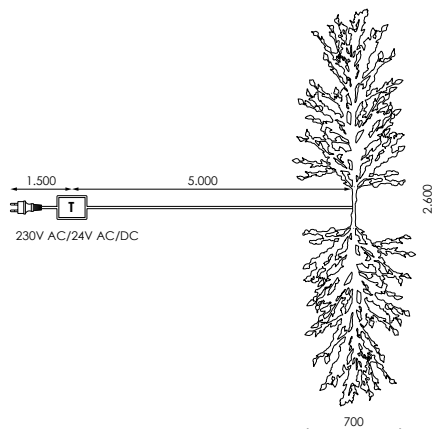

↕	2,6x0,7m
💡	600
W	48W
✂	NO Empalmable

	💡	⊞
953634	LED	👁
512909	LED	👁



# Branch *LED*

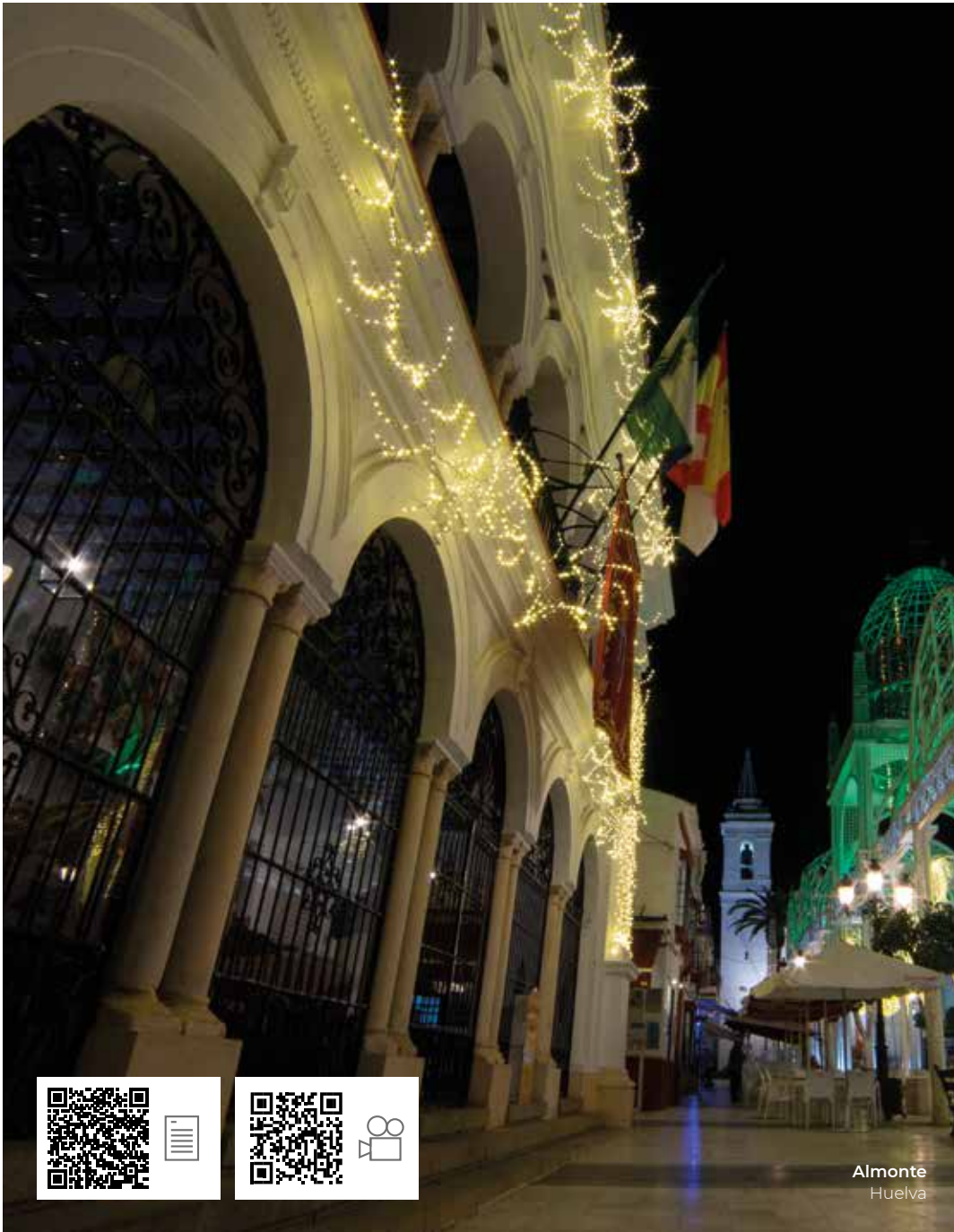

⚡	24V dc
Hz	50-60Hz
◇	CIII
⊙	IP44
TR	INC.
⊞	6ud





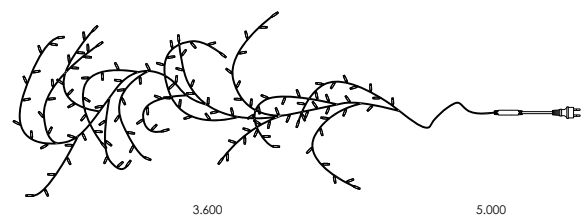

Almonte  
Huelva

	💡	∞
961998	LED	👁️
192866	LED	👁️
192873	LED	👁️







↔	3,6m
💡	288
W	16W
✖	NO Empalmable

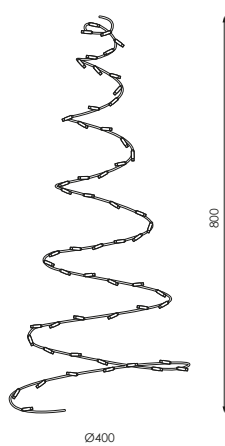

# Spiral

	24V
<b>Hz</b>	50-60Hz
	CIII
	IP44
	INC. 3m
	1ud



	Ø40x80cm			
	120	210522		
<b>W</b>	5,8W			
	NO Empalmable			

# Snow Tree



CC. Alhambra  
Ecuador

⚡	24V ac
Hz	50-60Hz
⚡	CIII
⊙	IP20
TR	INC. 3m
⊞	1ud

	💡	⊞
414715	LED	■

↕	1,5m
💡	186
W	7,2W
✖	NO Empalmable

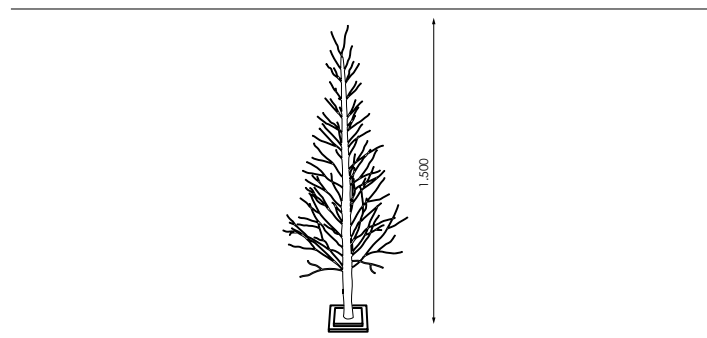

	💡	⊞
414722	LED	■

↕	1,8m
💡	270
W	9,6W
✖	NO Empalmable

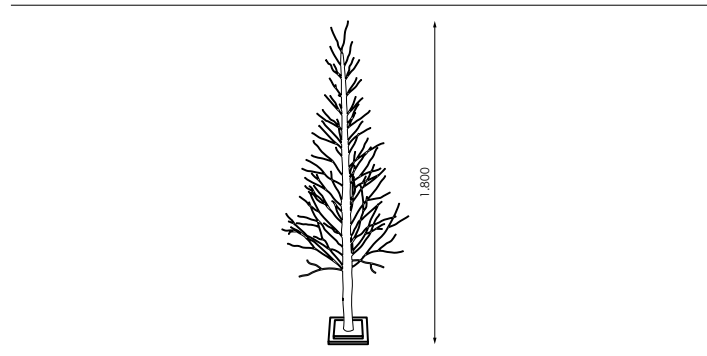



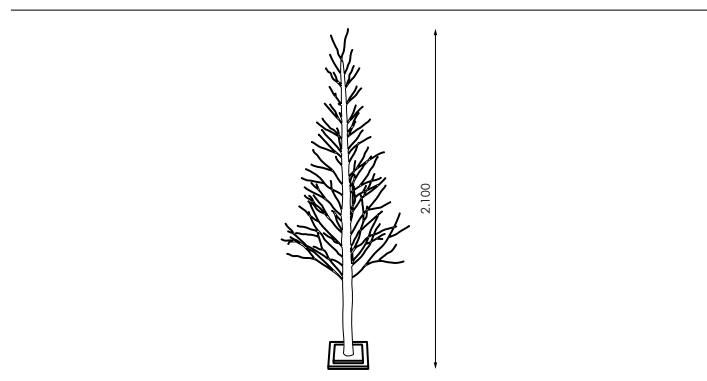

	💡	⊞
414739	LED	■

↕	2,1m
💡	306
W	12W
✖	NO Empalmable









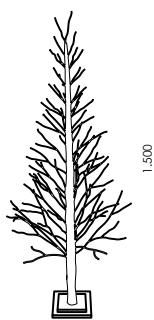
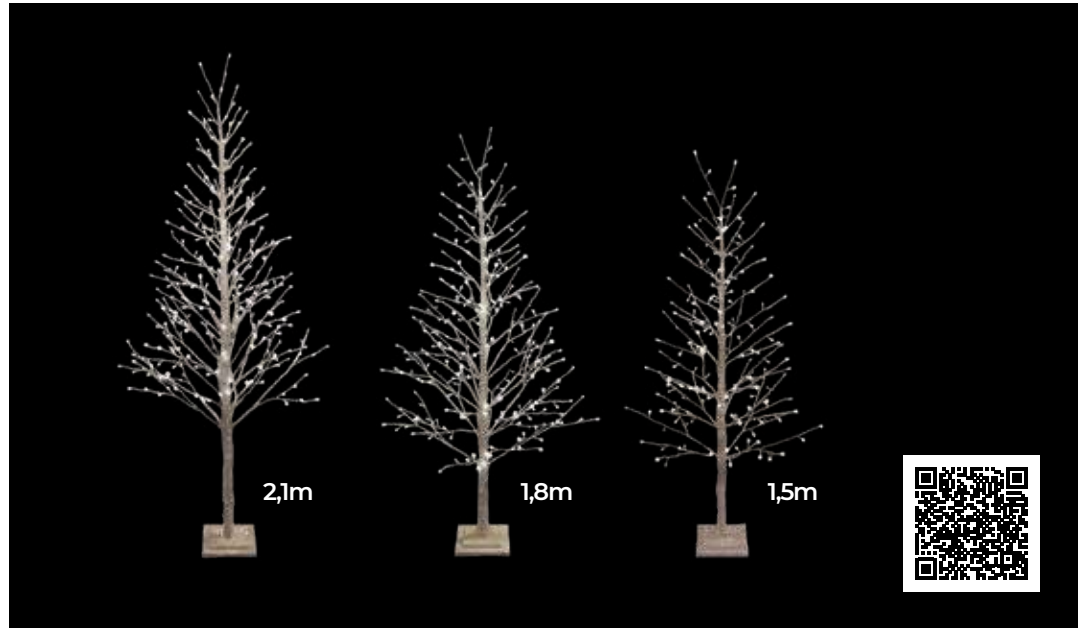



# Golden Tree



	24V ac
<b>Hz</b>	50-60Hz
	CIII
	IP20
	INC. 3m
	1ud





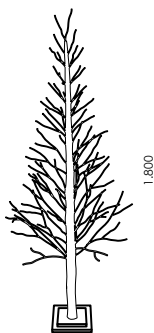

	1,5m
	186
<b>W</b>	7,2W
	NO Empalmable



		
414746		







	1,8m
	270
<b>W</b>	9,6W
	NO Empalmable

		
414753		



	2,1m
	306
<b>W</b>	12W
	NO Empalmable

		
414760		

[GRÁFICOS: Unidades en mm/ GRÁFICOS: Units in mm/GRAPHIQUES: Unités en mm/GRÁFICOS: Unidades em mm]

# Willow Tree

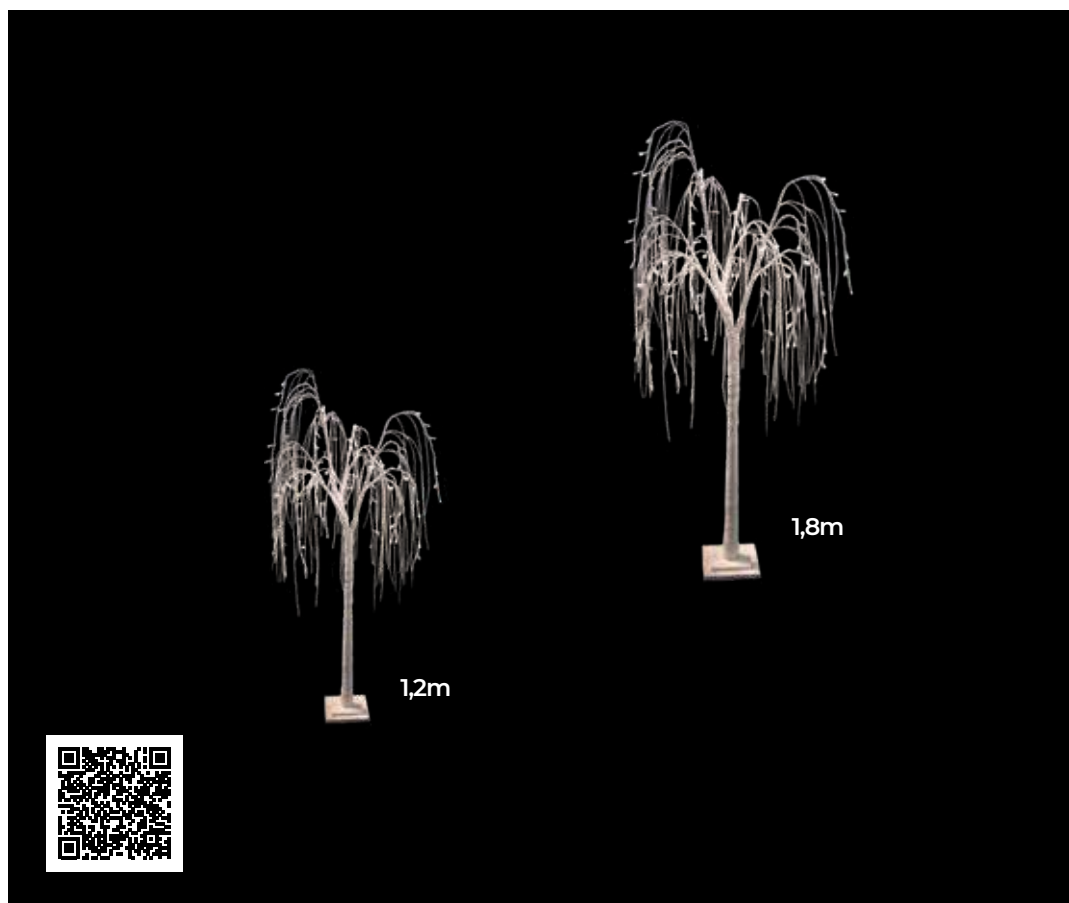

	3IV ac
<b>Hz</b>	50-60Hz
	CIII
	IP44
	1ud

390576		

	1,2m
	66
<b>W</b>	2,64W
	NO Empalmable
	INC. 3m

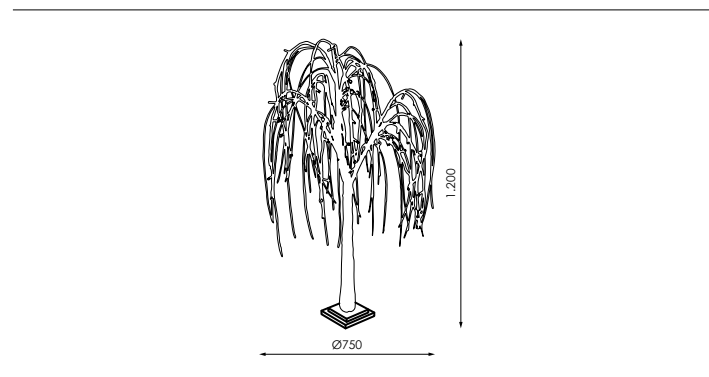



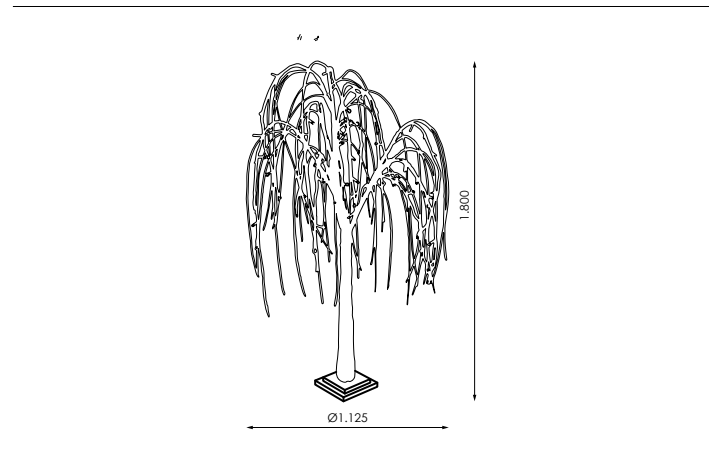

N 600613		



	1,8m
	360
<b>W</b>	3,6W
	NO Empalmable
	INC. 5m





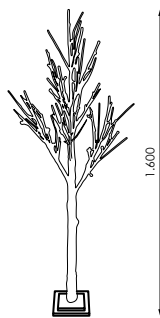
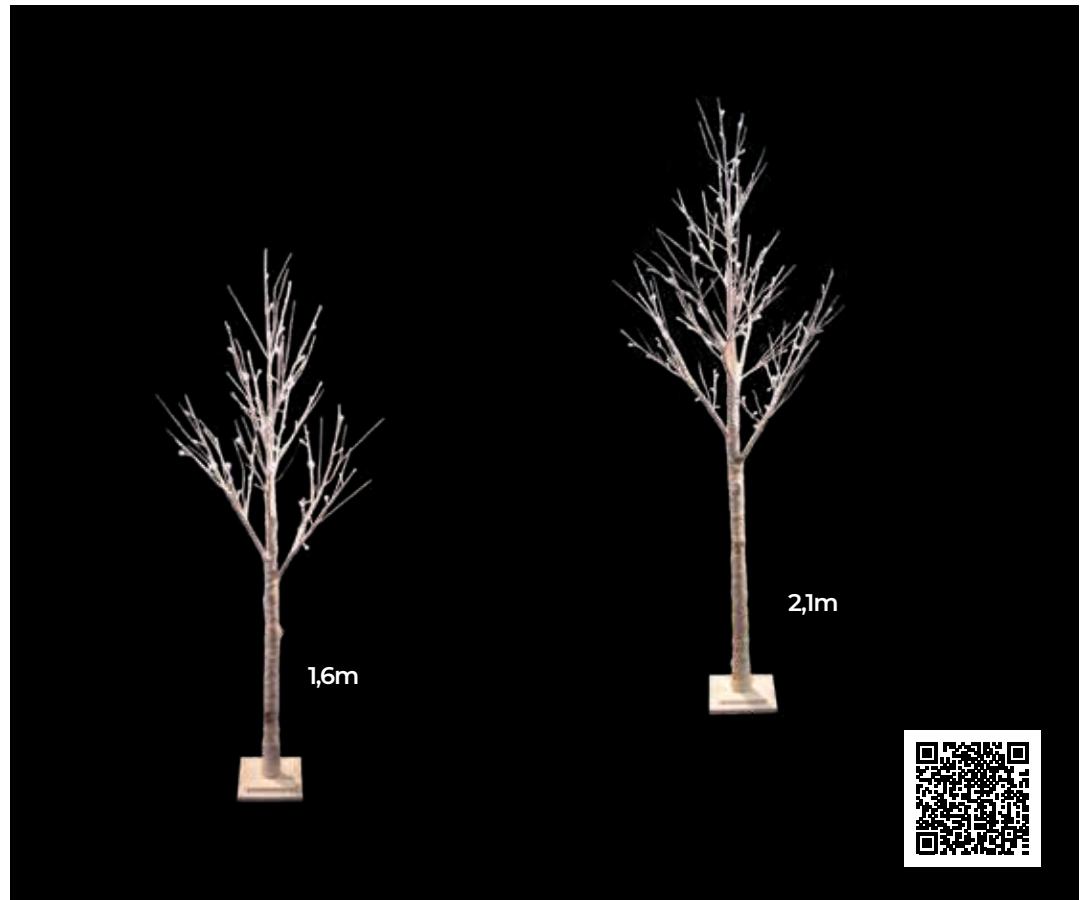

# Birch Tree



	24V ac
<b>Hz</b>	50-60Hz
	CIII
	IP20
	INC. 3m
	1ud





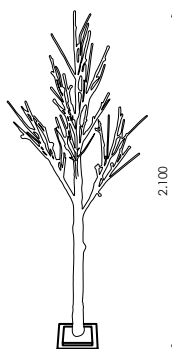

	1,6m
	54
<b>W</b>	2,16W
	NO Empalmable

		
390866		



	2,1m
	90
<b>W</b>	3,6W
	NO Empalmable

		
390873		



# Birch Forest Tree

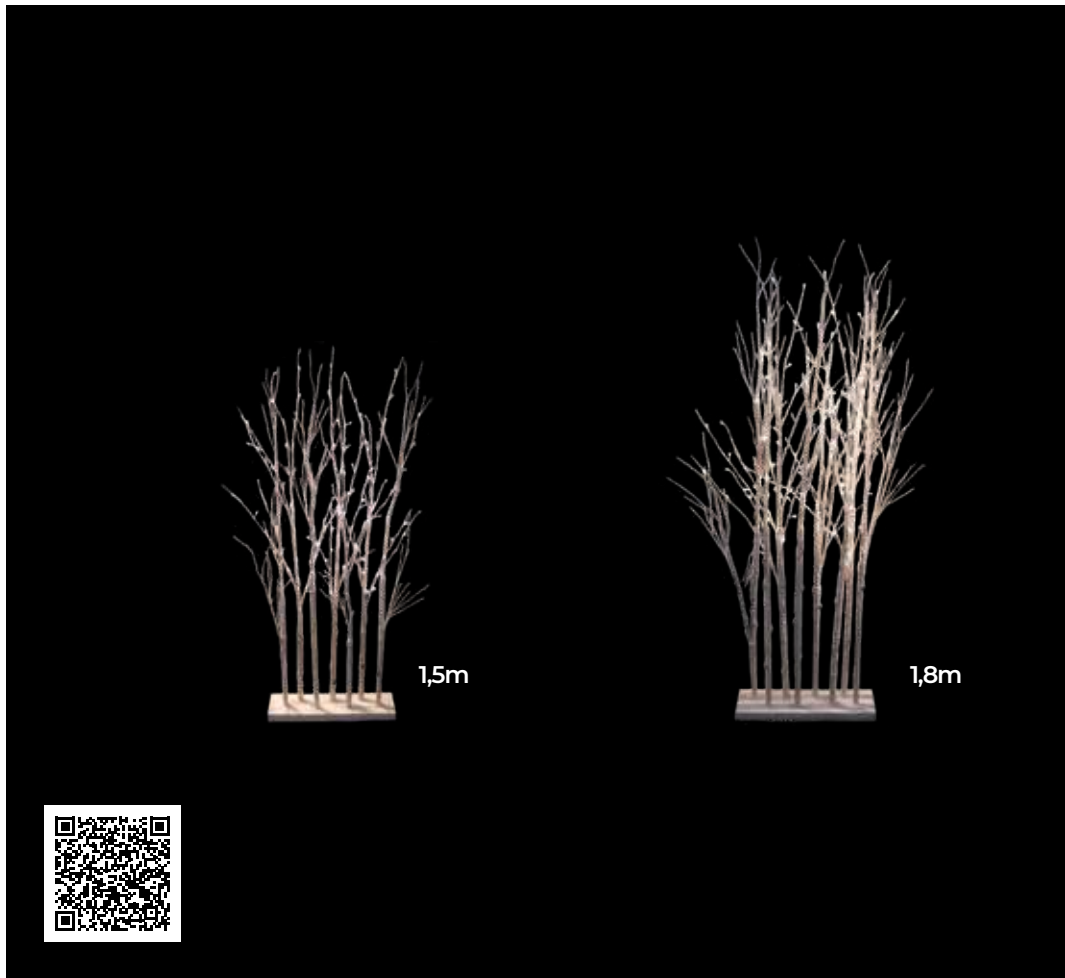

⚡	24V
Hz	50-60Hz
◇	CIII
⊙	IP44
TR	INC. 3m
⊞	1ud

	💡	⊞
390880	LED	□

↕	1,5m
💡	120
W	3,6W
✘	NO Empalmable

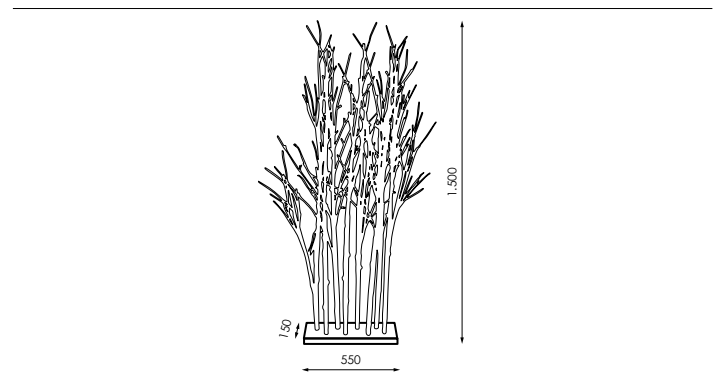



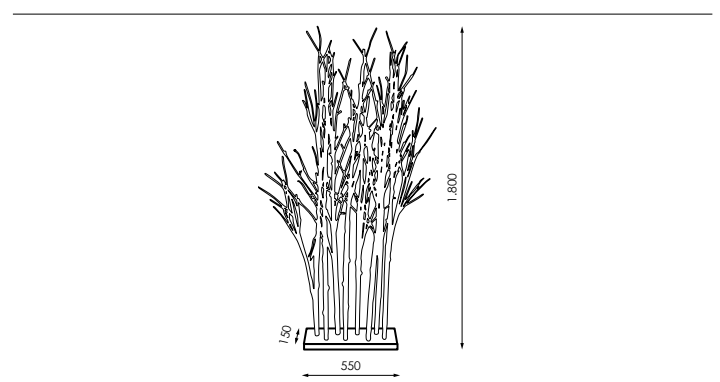

	💡	⊞
390897	LED	□



↕	1,8m
💡	128
W	3,84W
✘	NO Empalmable





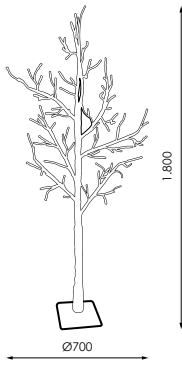

# Winter Tree

	24V
<b>Hz</b>	50-60Hz
	CIII
	IP44
	INC. 5m
	1ud





	1,8m
	96
<b>W</b>	3,6W
	NO Empalmable

		
240857		

[GRÁFICOS: Unidades en mm/ GRÁFICOS: Units in mm/ GRAPHICS: Units in mm/ GRÁFICOS: Unidades em mm/ GRÁFICOS: Unidades em mm]

# Green Christmas Tree





	
977425	Ø55~60x150cm
977432	Ø60~70x180cm
977449	Ø80~85x210cm



# Snowy Christmas Tree



	
977456	Ø55~60x150cm
977463	Ø60~70x180cm
977470	Ø80~85x210cm









# Ball 3D

Microled

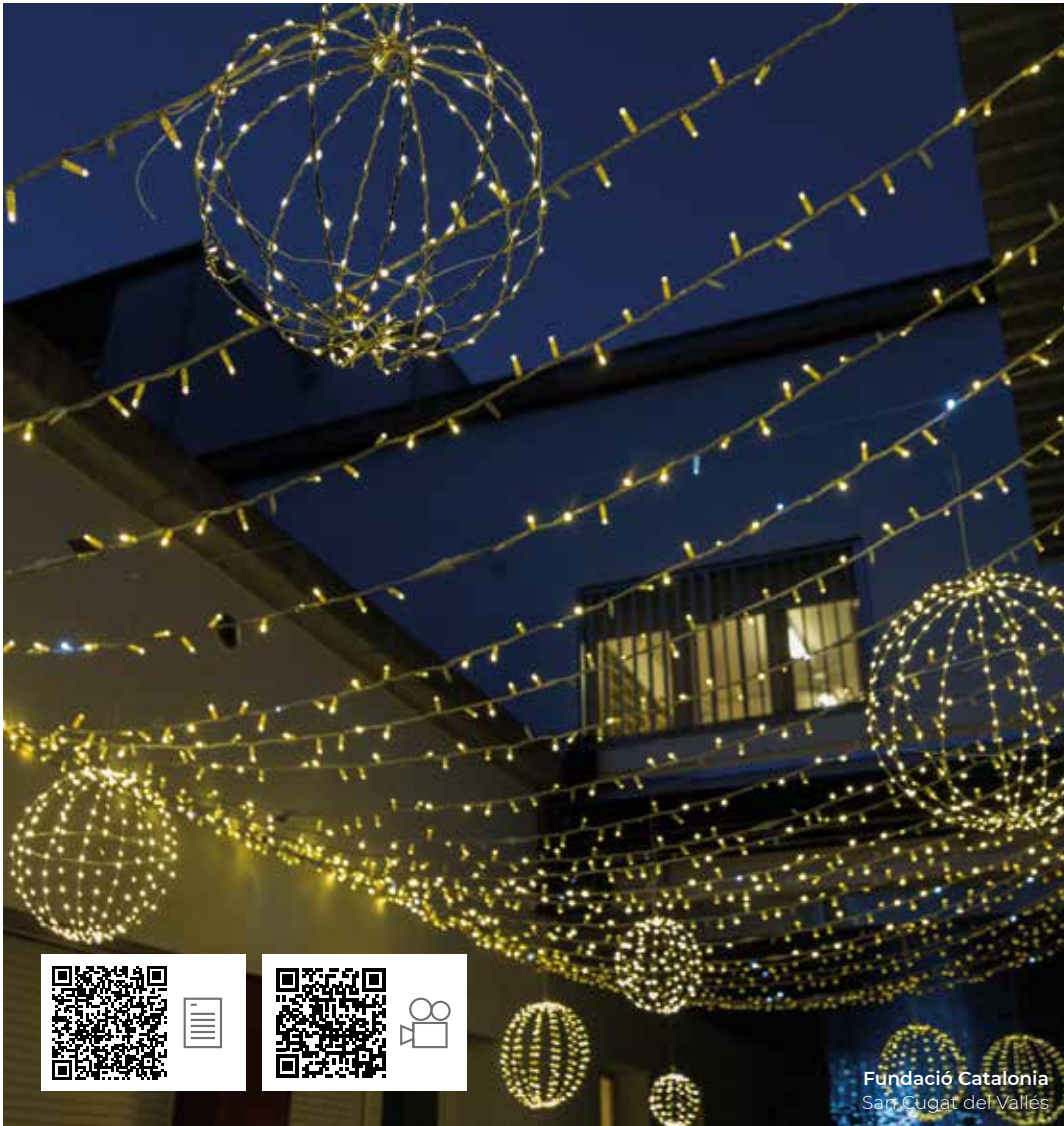

⚡ 24V

Hz 50-60Hz

◇ CIII

⊙ IP44

TR INC. 3m

⊞ 4ud



Fundació Catalonia  
San Cugat del Vallès

444392		

∅	∅30cm
	120
W	1,35W
	NO Empalmable

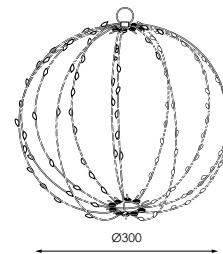



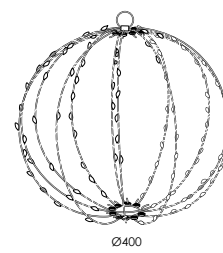

444408		

∅	∅40cm
	180
W	6W
	NO Empalmable







# Star Gold Line 3D



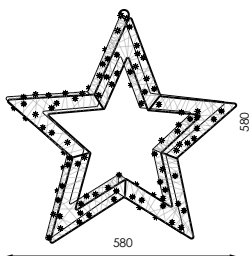

	4,6V
<b>Hz</b>	50-60Hz
	CIII
	IP20
	INC. 5m
	4ud







Canarias



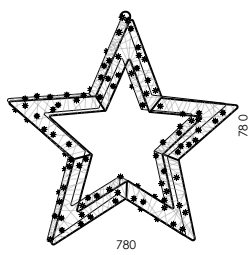



	58x58x8cm
	160
<b>W</b>	1,35W
	NO Empalmable
	Interior Indoors

		
444484		



	78x78x12cm
	240
<b>W</b>	1,35W
	NO Empalmable
	Interior Indoors

		
444491		



# Star Flat



⚡	4,5V
Hz	50-60Hz
◇	CIII
°	IP20
TR	INC. 3m
⊞	6ud

	💡	∞
444385	LED	■

↕	50x50cm
💡	60
W	1,35W
✖	NO Empalmable
🏠	Interior Indoors

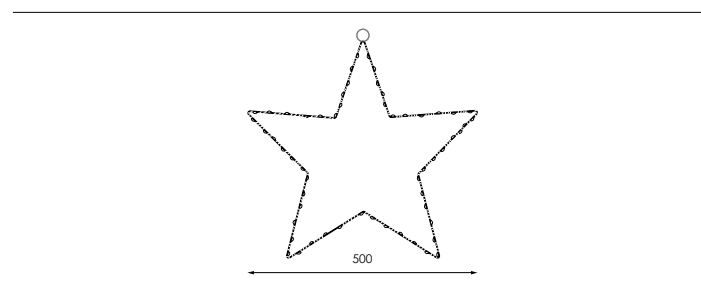

# Star Copper

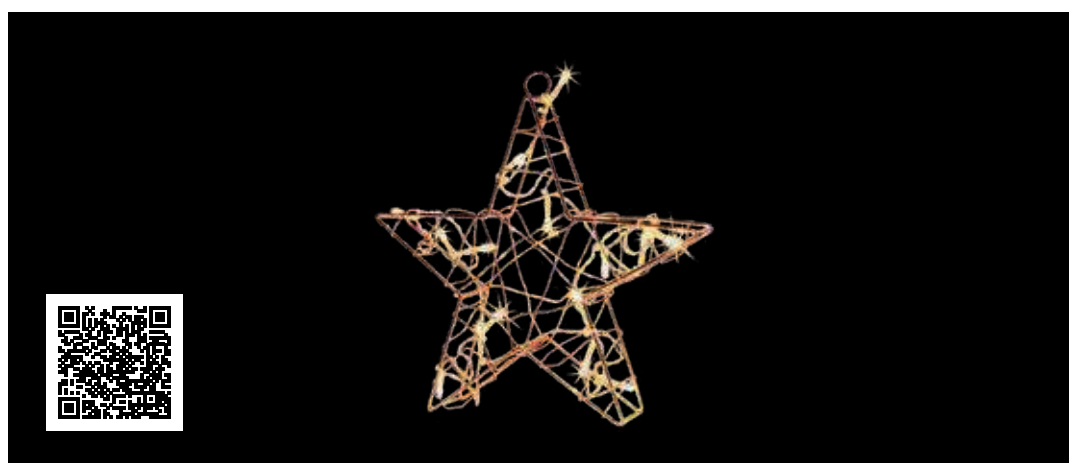



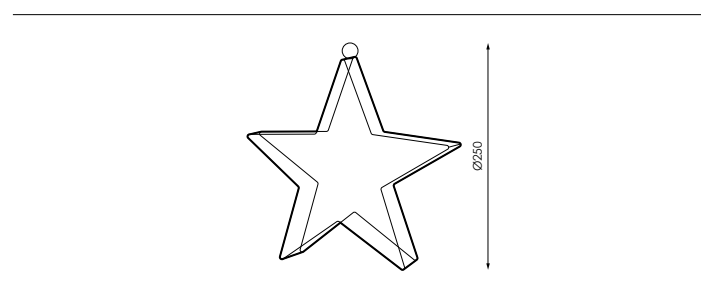

⚡	24V
Hz	50-60Hz
◇	CIII
°	IP20
TR	INC. 5m
⊞	6ud

	💡	∞
392297	LED	■





↕	25x25cm
💡	15
W	3W
✖	NO Empalmable
🏠	Interior Indoors



# Star Glass Balls





	3,2V
<b>Hz</b>	50-60Hz
	CIII
	IP20
	INC. 3m
	12ud







	Ø13cm
	1
	15
<b>W</b>	0,96W
	NO Empalmable
	Interior Indoors

	
444521	

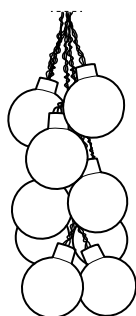
# Cluster Glass Balls

	3,2V
<b>Hz</b>	50-60Hz
	CIII
	IP20
	INC. 3m
	8ud



	Ø8cm
	10
<b>W</b>	0,96W
	NO Empalmable
	Interior Indoors

	
444538	

# Cotton Balls



⚡ 3,2V

Hz 50-60Hz

◇ CIII

⊙ IP20

TR INC. 3m

⊞ 12ud

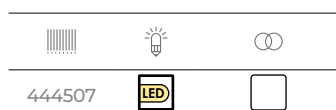

444507



∅ ∅6cm

⊞ 10

W 0,64W

✗ NO Empalmable

🏠 Interior Indoors

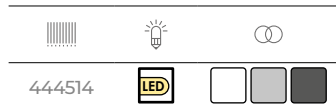
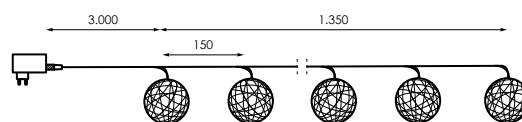

444514



∅ ∅6cm

⊞ 16

W 0,64W

✗ NO Empalmable

🏠 Interior Indoors

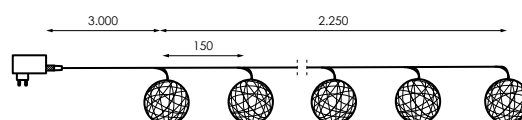



# Glass Balls Chain

⚡	3,2V
Hz	50-60Hz
⬠	CIII
⊙	IP20
TR	INC. 3m
⊞	12ud

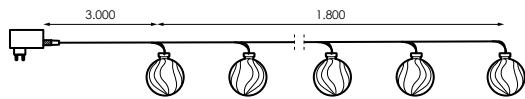

∅	∅6cm
⊞	10
W	0,96W
⊞	NO Empalmable
⬠	Interior Indoors

	⚡
444552	LED

# EsSense Plastic Balls

⚡	3,2V
Hz	50-60Hz
⬠	CIII
⊙	IP20
TR	INC. 3m
⊞	8ud

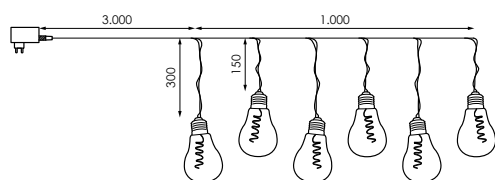

∅	∅9cm
⊞	6
W	0,96W
⊞	NO Empalmable
⬠	Interior Indoors

	⚡
444545	LED

# Spike Star

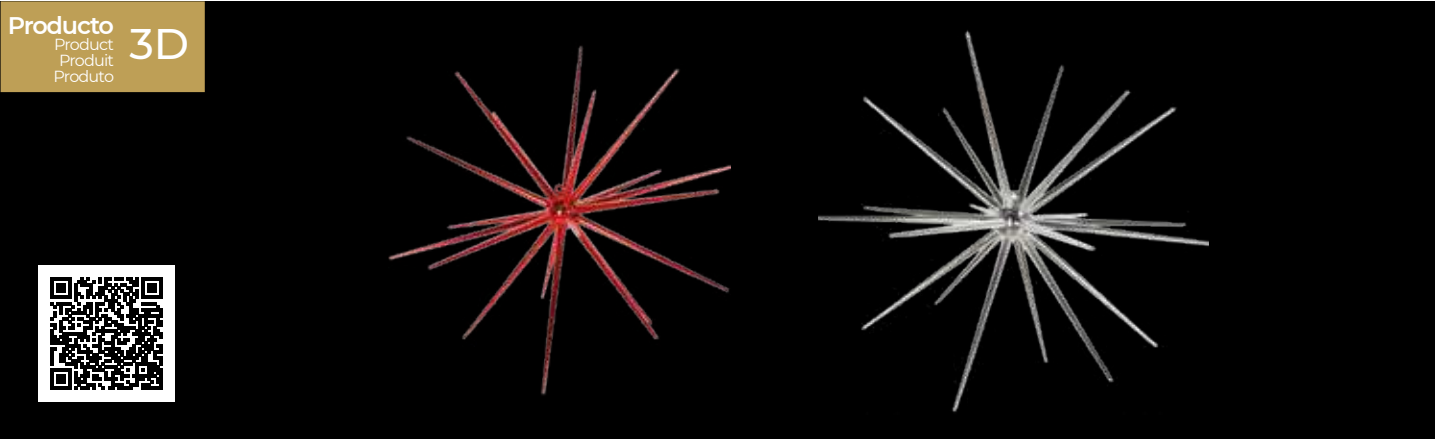

392181		60cm
392198		60cm

Interior  
Indoors

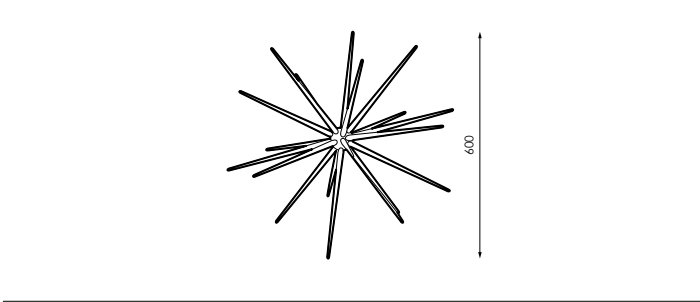

# Glitter Star

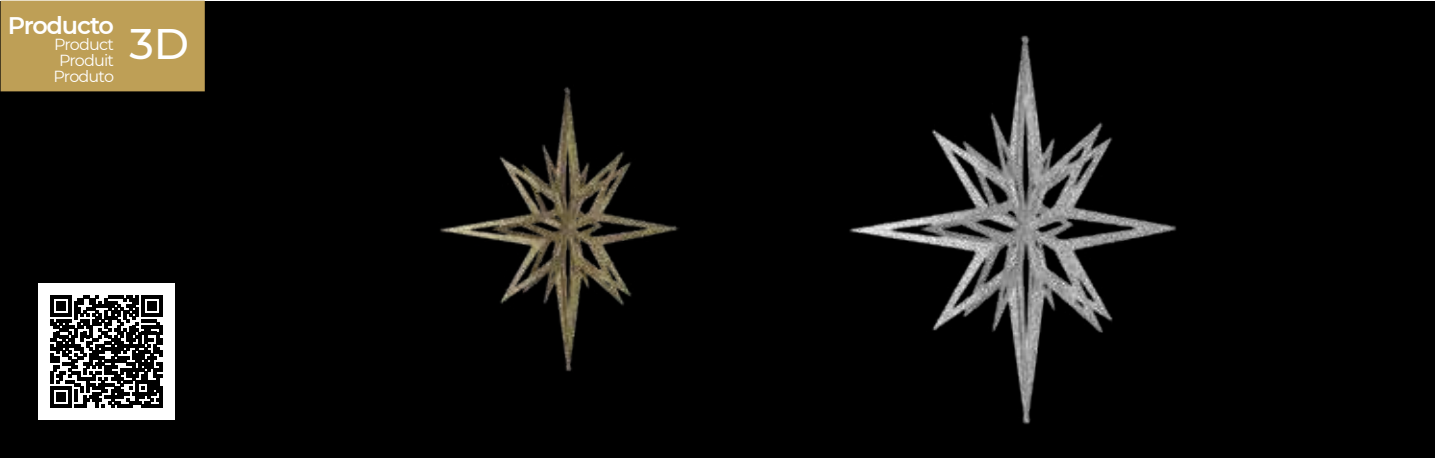

389143		30cm
389198		60cm

Interior  
Indoors

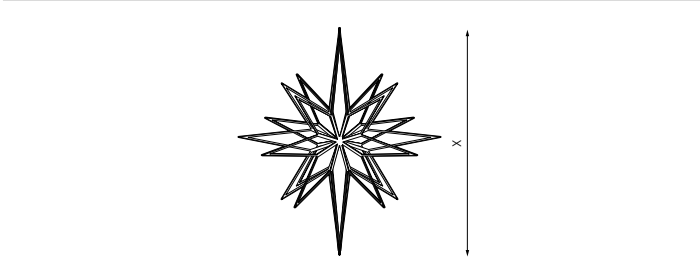

# Glitter Loop

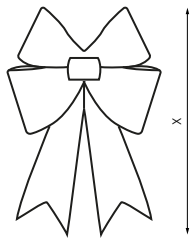
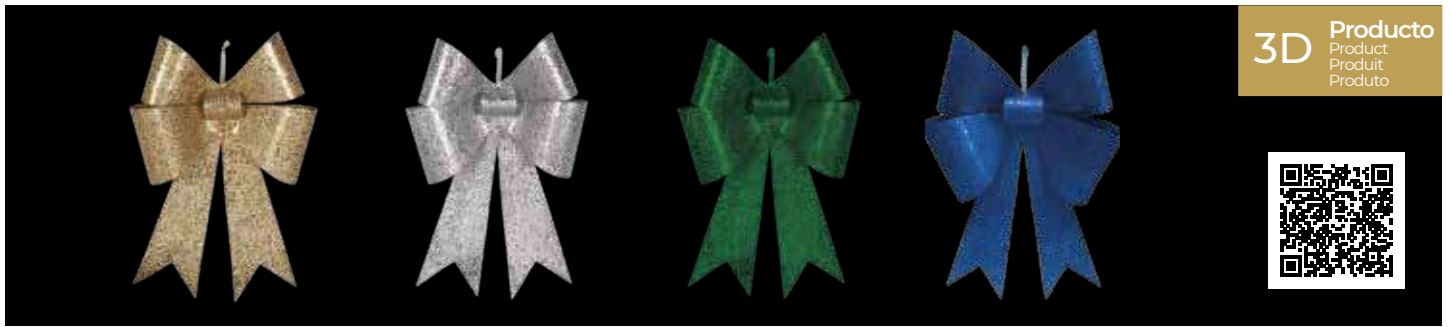

Icon	Interior Indoors	Barcode	Color	Size
🏠	Interior Indoors		🟡	46cm
			🟠	46cm
			🟢	46cm
			🟣	46cm
			🟡	76cm
			🟠	76cm
			🟢	76cm
			🟣	76cm

# Candy Cane

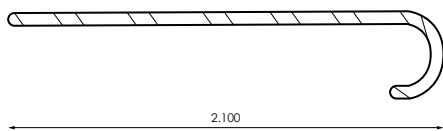
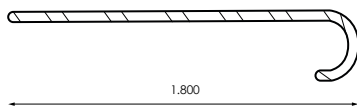

Icon	Dimensions	Barcode	Color	Size
📏	180x7,5x46cm		🟡	46cm
🏠	Interior Indoors		🟠	46cm
			🟢	46cm
			🟣	46cm
📏	210x7,5x46cm		🟡	46cm
🏠	Interior Indoors		🟠	46cm
			🟢	46cm
			🟣	46cm



# Ocean Comet



⚡	24V
Hz	50-60Hz
◇	CIII
⊙	IP20
TR	INC. 3m
📦	1ud

	💡	⊙
240734	LED	

↕	55x67cm
💡	24
W	1,44W
⊗	NO Empalmable
🏠	Interior Indoors
⤴	Para suspender To suspend

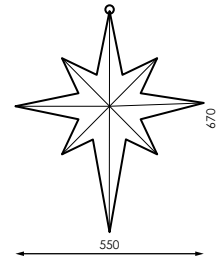

# Ocean Star



⚡	24V
Hz	50-60Hz
◇	CIII
⊙	IP20
TR	INC. 3m
📦	1ud

	💡	⊙
240741	LED	

↕	40x40cm
💡	24
W	1,44W
⊗	NO Empalmable
🏠	Interior Indoors
⤴	Para suspender To suspend

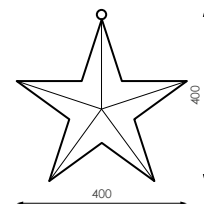

# Ocean Cone



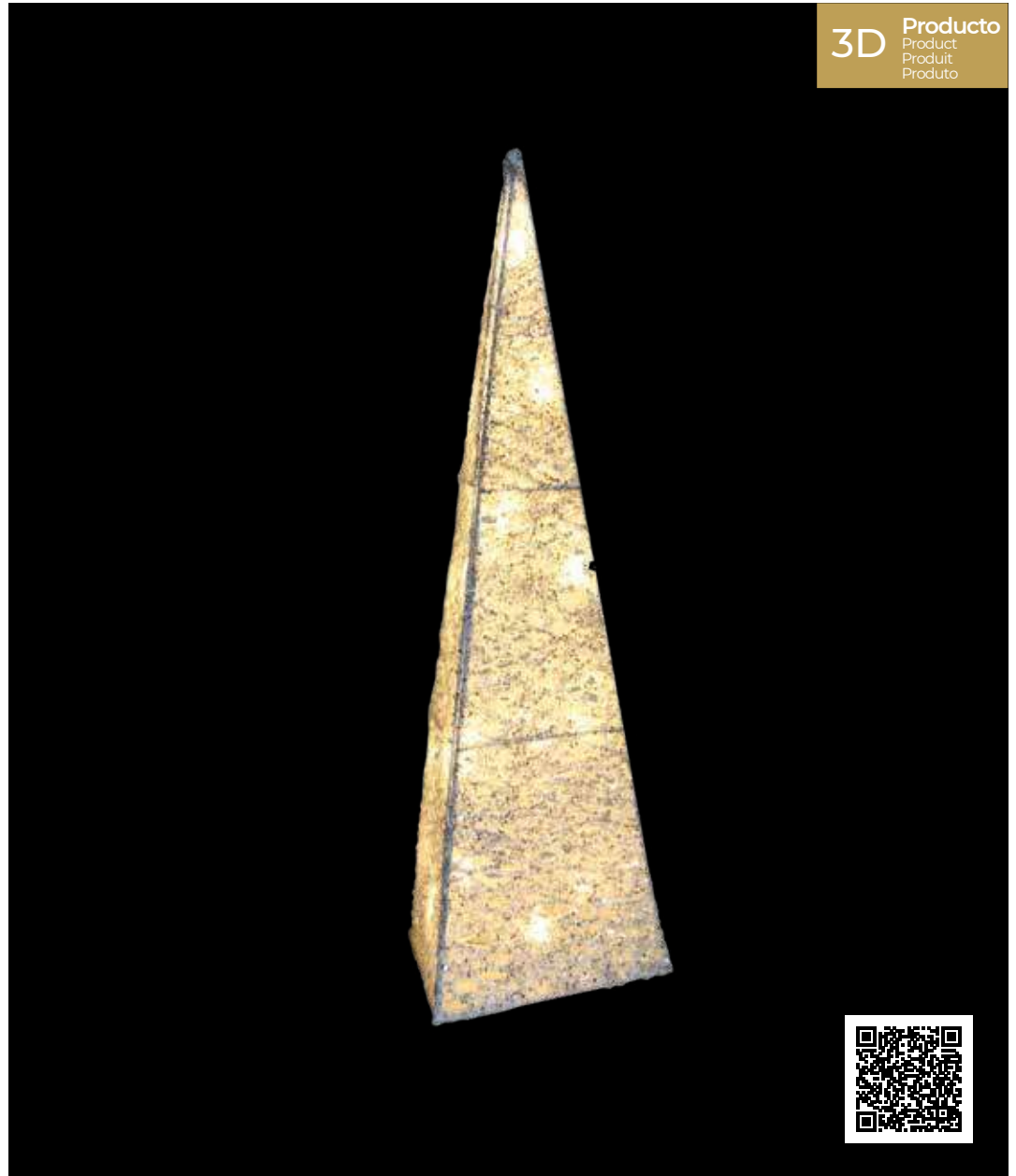

	24V
<b>Hz</b>	50-60Hz
	CIII
	IP20
	INC. 3m
	1ud



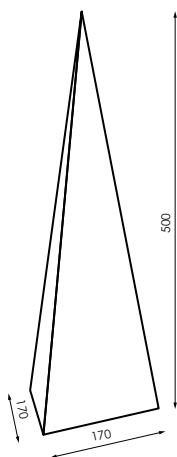



**3D** Product  
Product  
Produit  
Prodotto

[GRÁFICOS: Unidades en mm/ GRÁFICOS: Units in mm/GRAPHIQUES: Unités en mm/GRÁFICOS: Unidades em mm]



	50x17x17cm
	16
<b>W</b>	0,96W
	NO Empalmable
	Interior Indoors

		
240758		

# Elegant Cone



Producto  
Product  
Produit  
Produto

3D

⚡ 31V

Hz 50-60Hz

◇ CIII

⊙ IP44

TR INC.

📦 1ud

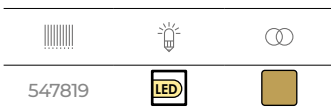

547819

LED



↕ 80x20x20cm

💡 40

W 3,6W

✘ NO Empalmable

🏠 Interior Indoors

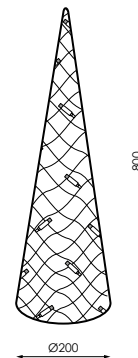

800

Ø200

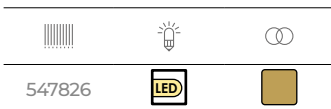

547826

LED



↕ 100x26x26cm

💡 70

W 3,6W

✘ NO Empalmable

🏠 Interior Indoors

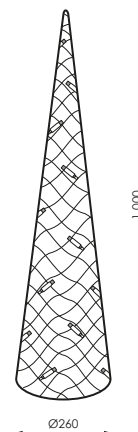

1.000

Ø260



# Elegant Gift

⚡	31V
Hz	50-60Hz
⬠	CIII
⊙	IP44
TR	INC.
⊞	1ud

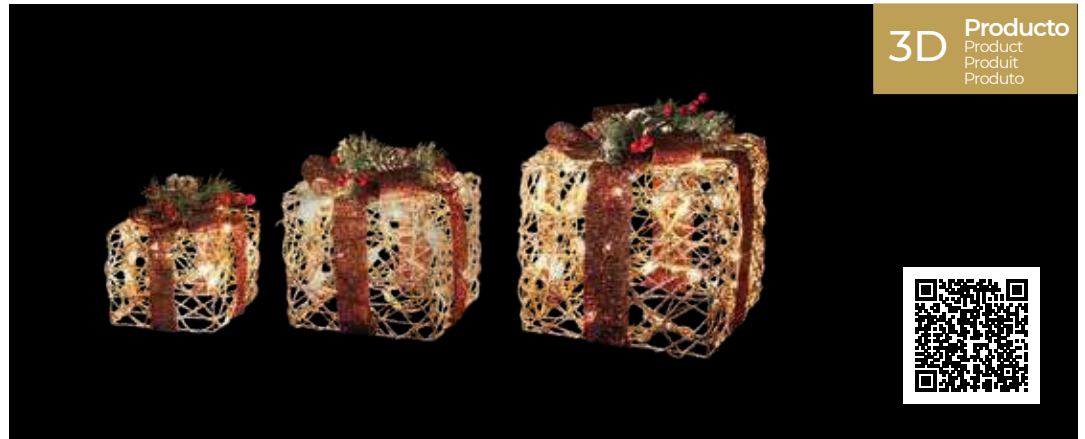

3D Producto  
Product  
Produit  
Produto

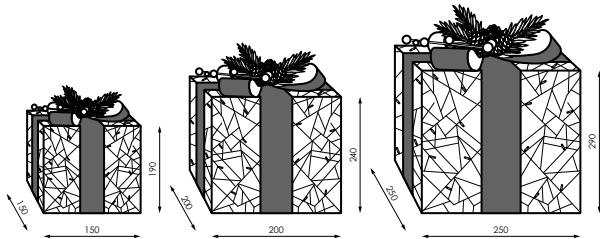

💡	10/20/35		💡	⊞
W	3,6W	547802	LED	■
✖	NO Empalmable			
🏠	Interior Indoors			

# Elegant Deer

132cm

⚡	31V
Hz	50-60Hz
⬠	CIII
⊙	IP44
TR	INC.
⊞	1ud



3D Producto  
Product  
Produit  
Produto

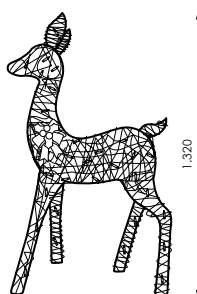

↕	132cm		💡	⊞
💡	240	563291	LED	■
W	3,6W			
✖	NO Empalmable			
🏠	Interior Indoors			

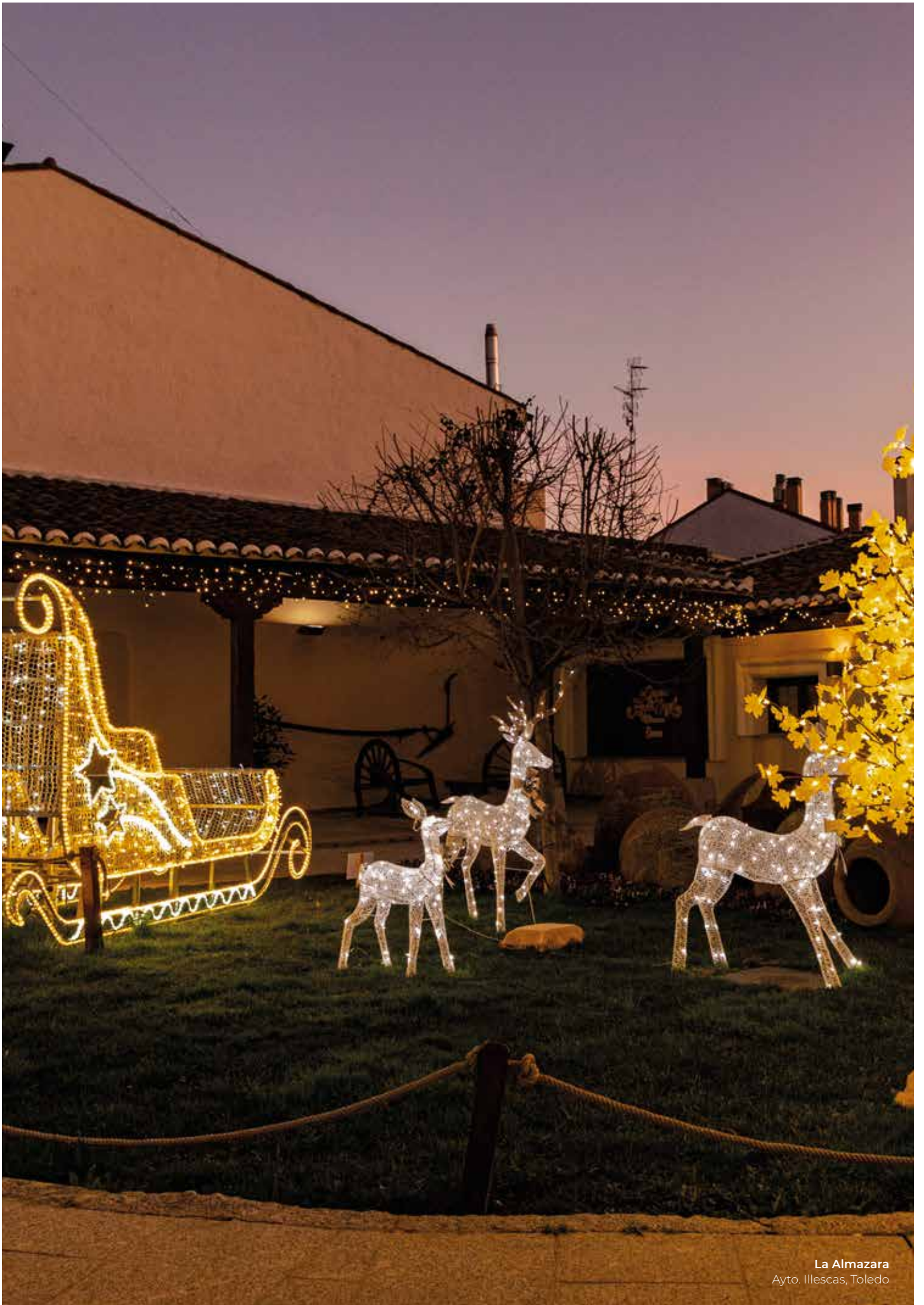

La Almazara  
Ayto. Illescas, Toledo

# Glaciar Deer Set

⚡ 31V

Hz 50-60Hz

⬠ CIII

⊙ IP44

⊠ INC.

⊠ 1ud

3D Producto  
Product  
Produit  
Produto

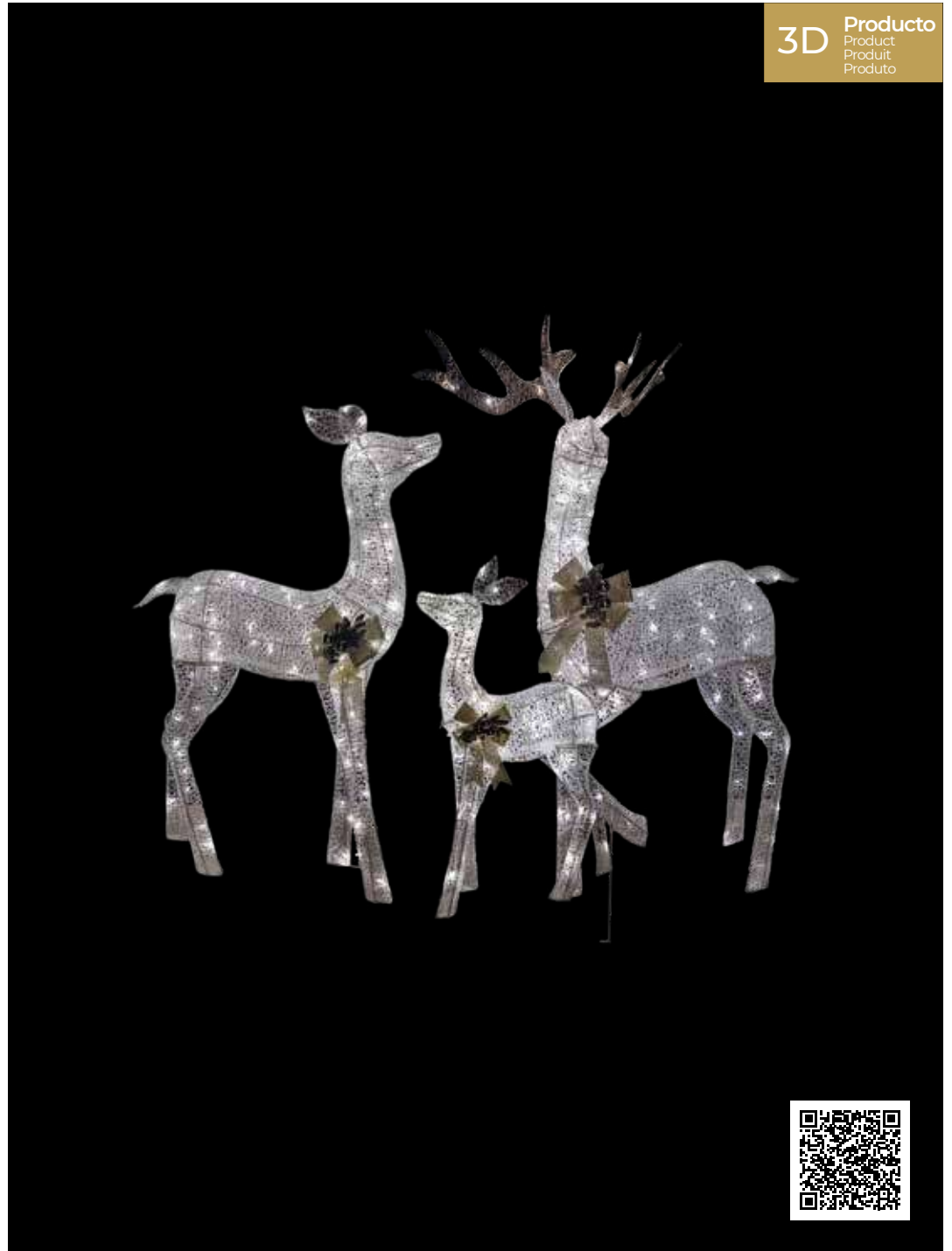

[GRÁFICOS: Unidades en mm/ GRÁFICOS: Units in mm/GRAPHIQUES: Unités en mm/GRÁFICOS: Unidades em mm]

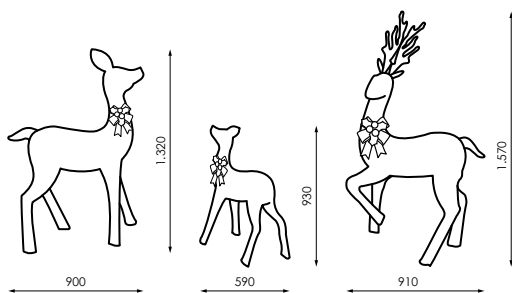

Ver gráfico



150/120/80

W

12W



NO  
Empalmable



507097







LED









# Christmas Balls

			
	Ø10cm	3/96	543620
	Ø15cm	4/24	543804
	Ø20cm	1/12	543989





Azul Glitter  
Blue Glitter  
Bleu Glitter  
Azul Glitter

			
	Ø10cm	3/96	543613
	Ø15cm	4/24	543798
	Ø20cm	1/12	543972





Verde Glitter  
Green Glitter  
Vert Glitter  
Verde Glitter

			
	Ø10cm	3/96	972574
	Ø12cm	144	972635
	Ø15cm	4/24	972697
	Ø20cm	1/12	972758





Azul Brillo  
Blue Shiny  
Bleu Brillant  
Azul Brilho

			
	Ø10cm	3/96	979238

Verde Brillo  
Green Shiny  
Vert Brillant  
Verde Brilho

			
	Ø7cm	10/240	410878
	Ø10cm	3/96	411011
	Ø15cm	4/24	411097
	Ø20cm	1/12	411127

Azul Mate  
Blue Matt  
Bleu Mat  
Azul Matt

			
	Ø10cm	3/96	998093
	Ø15cm	4/24	998109
	Ø20cm	1/12	998116





Verde Mate  
Green Matt  
Vert Mat  
Verde Matt

			
	Ø20cm	1/12	544115





Blanco Glitter  
White Glitter  
Blanc Glitter  
Branco Glitter

			
	Ø10cm	3/96	543736
	Ø15cm	4/24	543910
	Ø20cm	1/12	544092

Negro Glitter  
Black Glitter  
Noir Glitter  
Preto Glitter

			
	Ø15cm	4/24	543927
	Ø20cm	1/12	544108



Blanco Brillo  
White Shiny  
Blanc Brillant  
Branco Brilho

			
	Ø7cm	10/240	543545
	Ø10cm	3/96	543729
	Ø15cm	4/24	543903
	Ø20cm	1/12	544085

Negro Mate  
Black Matt  
Noir Mat  
Preto Matt





			
	Ø20cm	1/12	193108

Marfil Brillo  
Ivory Shiny  
Ivoire Brillant  
Marfim Brilho

			
	Ø7cm	10/240	543408

Oro Glitter  
Gold Glitter  
Or Glitter  
Ouro Glitter





# Christmas Balls

			
	Ø7cm	10/240	543422
	Ø10cm	3/96	543606
	Ø15cm	4/24	543781
	Ø20cm	1/12	543965



Granate Glitter  
Garnet Glitter  
Grenat Glitter  
Granada Glitter

			
	Ø7cm	10/240	543415
	Ø10cm	3/96	543590
	Ø15cm	4/24	543774
	Ø20cm	1/12	543958





Plata Glitter  
Silver Glitter  
Argent Glitter  
Prata Glitter

			
	Ø7cm	10/240	972499
	Ø10cm	3/96	972550
	Ø15cm	4/24	972673
	Ø20cm	1/12	972734





Granate Brillo  
Garnet Shiny  
Grenat Brillor  
Granada Brilhoso

			
	Ø7cm	10/240	972482
	Ø10cm	3/96	972543
	Ø15cm	4/24	972666

Plata Brillo  
Silver Shiny  
Argent Brillor  
Prata Brilhoso

			
	Ø7cm	10/240	972505
	Ø10cm	3/96	972567
	Ø15cm	4/24	972680
	Ø20cm	1/12	972741

Granate Mate  
Garnet Matt  
Grenat Mat  
Granada Matt

			
	Ø7cm	10/240	410915
	Ø10cm	3/96	411042
	Ø15cm	4/24	411103





Plata Mate  
Silver Matt  
Argent Mat  
Prata Matt

			
	Ø10cm	3/96	543682
	Ø15cm	4/24	543866
	Ø20cm	1/12	544047



Cobre Glitter  
Copper Glitter  
Cuivre Glitter  
Cobre Glitter

			
	Ø10cm	3/96	543712
	Ø15cm	4/24	543897
	Ø20cm	1/12	544078





Olive Glitter  
Olive Glitter  
Olive Glitter  
Olive Glitter

			
	Ø10cm	3/96	543668
	Ø15cm	4/24	543842
	Ø20cm	1/12	544023





Cobre Brillo  
Copper Shiny  
Cuivre Brillor  
Cobre Brilhoso

			
	Ø10cm	3/96	543699
	Ø15cm	4/24	543873
	Ø20cm	1/12	544054

Olive Brillo  
Olive Shiny  
Olive Brillor  
Olive Brilhoso

			
	Ø7cm	10/240	543491
	Ø10cm	3/96	543675
	Ø15cm	4/24	543859
	Ø20cm	1/12	544030

Cobre Mate  
Copper Matt  
Cuivre Mat  
Cobre Matt

			
	Ø10cm	3/96	543705
	Ø15cm	4/24	543880
	Ø20cm	1/12	544061

Olive Mate  
Olive Matt  
Olive Mat  
Olive Matt

# Christmas Balls



			
	Ø10cm	3/96	543651
	Ø15cm	4/24	543835
	Ø20cm	1/12	544016

Rosa Glitter  
Pink Glitter  
Rose Glitter  
Rosa Glitter

			
	Ø10cm	3/96	543637
	Ø15cm	4/24	543811
	Ø20cm	1/12	543996

Rosa Brillo  
Pink Shiny  
Rose Briller  
Rosa Brilho





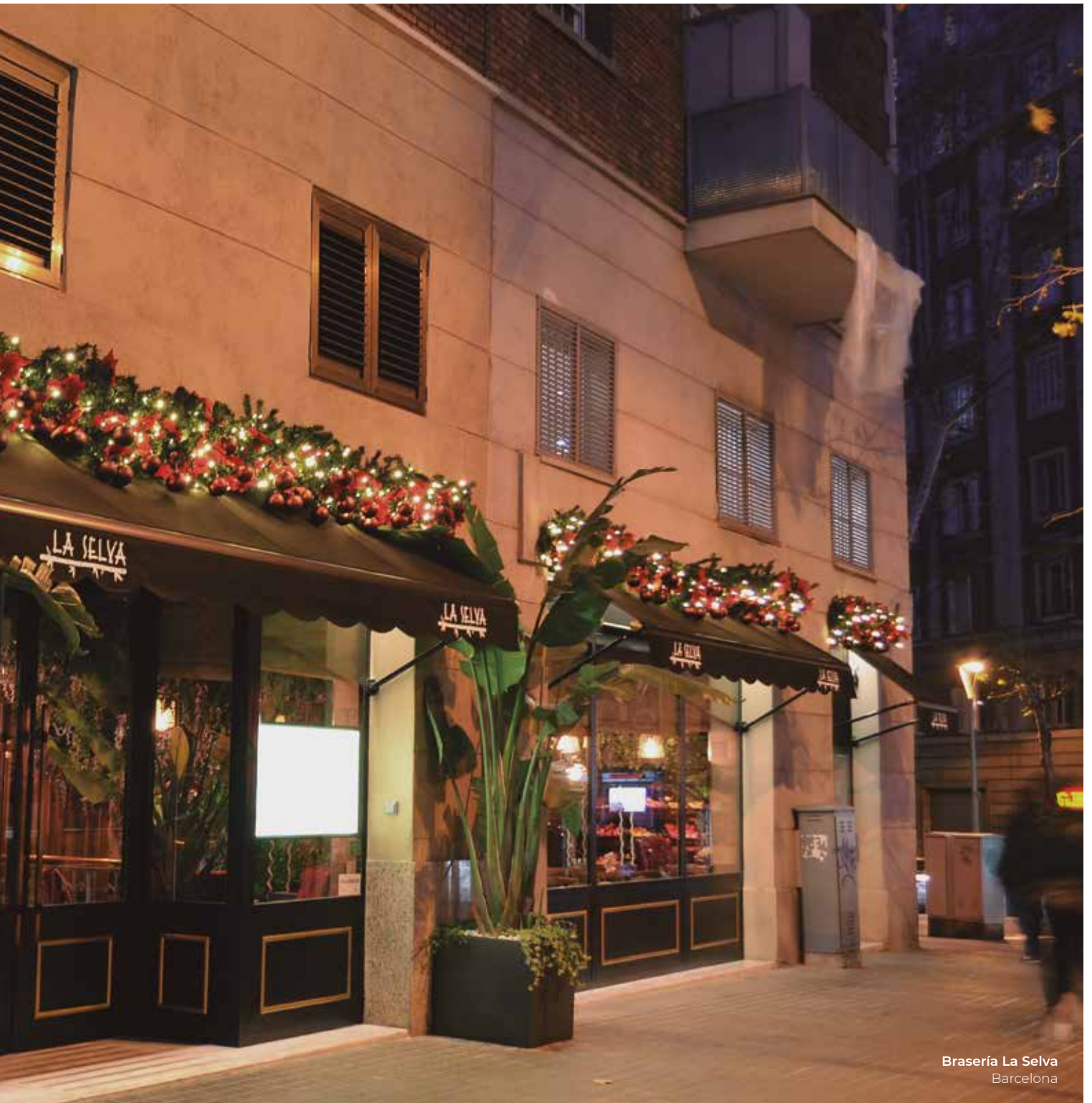

# Christmas Balls



Brasería La Selva  
Barcelona

GRÁFICOS: Unidades en mm/ GRAPH

				
	Rosa Mate	Ø10cm	3/96	543644
	Pink Matt	Ø15cm	4/24	543828
	Rose Mat Rosa Matt	Ø20cm	1/12	544009

# Cluster Balls



Barcode	Color Options
210799	Red star, Gold star
411134	White star, Blue
411141	Red star, Grey
411158	Grey, Gold star

Dimensions	Weight
29x19,3cm	1ud

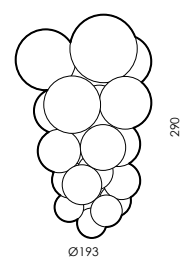

Barcode	Color Options
411172	White star, Blue
411189	Red star, Grey
411196	Grey, Gold star

Dimensions	Weight
36x21cm	1ud

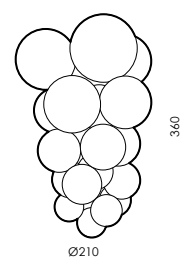





977487		30mx60cm	Rollo 30m



977494		30mx60cm	Rollo 30m



998000		30mx60cm	Rollo 30m



997980		30mx60cm	Rollo 30m



997997		30mx60cm	Rollo 30m



157001		30mx60cm	Rollo 30m



## Información/Information/Information/Informações

**N**/ Ideal para árboles, conos gigantes y decoración de pasillos y fachadas.

**E**/ Ideal for trees, giant cones and decoration of halls and facades.

**F**/ Idéal pour les arbres, les cônes géants et décoration de salles et façades.

**P**/ Ideal para árvores, conos gigantes e decoração de paredes e fachadas.



# Tapiz Metalizado



Barcode	Color	Description
093712	Azul	Azul/Blue/Bleu/Azul
093705	Verde	Verde/Green/Vert/Verde
093651	Rojo	Rojo/Red/Rouge/Vermelha
093675	Oro claro	Oro claro/Clear gold/Or clair/Limpar ouro
093743	Plata	Plata/Silver/Argent/Prata
093736	Negro	Negro/Black/Noir/Preto
962018	Blanco	Blanco/White/Blanc/Branca

Dimensions icon	2500x90cm
Roll icon	Rollo 25m

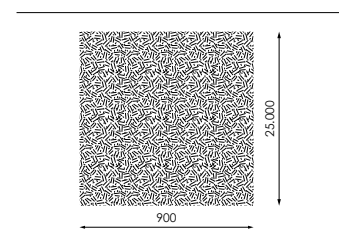

# Tapiz Tradicional

Barcode	Color	Description
061414	Verde	Verde/Green/Vert/Verde
061421	Blanco	Blanco/White/Blanc/Branca
061438	Amarillo	Amarillo/Yellow/Jaune/Amarela
061445	Rojo	Rojo/Red/Rouge/Vermelha
061452	Azul	Azul/Blue/Bleu/Azul
086110	Marrón	Marrón/Brown/Brun/Marrom
086127	Naranja	Naranja/Orange/Orange/Laranaja
952842	Rosa	Rosa/Pink/Rose/Rosa

Dimensions icon	2500x90cm
Roll icon	Rollo 25m

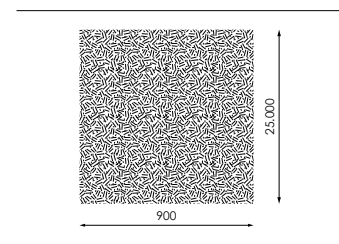

## Aviso/Warning/Avertissement/Aviso

**Ñ/ NO APTO** para lugares con alta concentración de niebla salina tales como zonas costeras, puertos marítimos o puertos.  
**NO** cubierto por la garantía bajo dichas circunstancias.

**E/ NOT SUITABLE** for areas with a high concentration of salt spray such as foreshores and harbours.  
**NOT** warranty under such circumstances.

**F/ NE CONVIENT PAS** pour les régions avec une forte concentration de brouillard salin tels que les estrans et les ports.  
**PAS** couvert par la garantie dans de telles circonstances.

**P/ NÃO APROPRIADO** para áreas com alta concentração de névoa salina, como costas e portos.  
**NÃO** cobertos pela garantia sob tais circunstâncias.

# Garland



[GRÁFICOS: Unidades en mm/ GRÁFICOS: Units in mm/GRÁFICOS: Unidades em mm/GRÁFICOS: Unidades em mm]

	Ø8x1.000cm Rollo 10m	<table border="1"> <tbody> <tr> <td>486583</td> <td></td> <td>Dorado metálico/Gold metallic/ Or métallique/Ouro metálico</td> </tr> <tr> <td>486590</td> <td></td> <td>Plata metálico/Silver metallic/ Argent métallique/Prata metálico</td> </tr> <tr> <td>486545</td> <td></td> <td>Rojo metálico/Red metallic/ Rouge métallique/Vermelho metálico</td> </tr> <tr> <td>486576</td> <td></td> <td>Azul metálico/Blue metallic/ Bleu métallique/Azul metálico</td> </tr> <tr> <td>486606</td> <td></td> <td>Verde mate/Green matt/ Vert mat/Verde mate</td> </tr> </tbody> </table>	486583		Dorado metálico/Gold metallic/ Or métallique/Ouro metálico	486590		Plata metálico/Silver metallic/ Argent métallique/Prata metálico	486545		Rojo metálico/Red metallic/ Rouge métallique/Vermelho metálico	486576		Azul metálico/Blue metallic/ Bleu métallique/Azul metálico	486606		Verde mate/Green matt/ Vert mat/Verde mate
486583		Dorado metálico/Gold metallic/ Or métallique/Ouro metálico															
486590		Plata metálico/Silver metallic/ Argent métallique/Prata metálico															
486545		Rojo metálico/Red metallic/ Rouge métallique/Vermelho metálico															
486576		Azul metálico/Blue metallic/ Bleu métallique/Azul metálico															
486606		Verde mate/Green matt/ Vert mat/Verde mate															
	Ø12x1.000cm Rollo 10m	<table border="1"> <tbody> <tr> <td>486644</td> <td></td> <td>Dorado metálico/Gold metallic/ Or métallique/Ouro metálico</td> </tr> <tr> <td>486651</td> <td></td> <td>Plata metálico/Silver metallic/ Argent métallique/Prata metálico</td> </tr> <tr> <td>486613</td> <td></td> <td>Rojo metálico/Red metallic/ Rouge métallique/Vermelho metálico</td> </tr> <tr> <td>486637</td> <td></td> <td>Azul metálico/Blue metallic/ Bleu métallique/Azul metálico</td> </tr> <tr> <td>486668</td> <td></td> <td>Verde mate/Green matt/ Vert mat/Verde mate</td> </tr> </tbody> </table>	486644		Dorado metálico/Gold metallic/ Or métallique/Ouro metálico	486651		Plata metálico/Silver metallic/ Argent métallique/Prata metálico	486613		Rojo metálico/Red metallic/ Rouge métallique/Vermelho metálico	486637		Azul metálico/Blue metallic/ Bleu métallique/Azul metálico	486668		Verde mate/Green matt/ Vert mat/Verde mate
486644		Dorado metálico/Gold metallic/ Or métallique/Ouro metálico															
486651		Plata metálico/Silver metallic/ Argent métallique/Prata metálico															
486613		Rojo metálico/Red metallic/ Rouge métallique/Vermelho metálico															
486637		Azul metálico/Blue metallic/ Bleu métallique/Azul metálico															
486668		Verde mate/Green matt/ Vert mat/Verde mate															



# Green Branch



507042



3.000x45cm



Rollo 3m



3.000

# Tapiz Net



484206



Dorado metálico/Gold metallic/  
Or métallique/Ouro metálico

484213



Plata metálico/Silver metallic/  
Argent métallique/Prata metálico

484220



Rojo metálico/Red metallic/  
Rouge métallique/Vermelho metálico

484237



Verde metálico/Green metallic/  
Vert métallique/Verde metálico

484244



Azul metálico/Blue metallic/  
Bleu métallique/Azul metálico

484251



Verde mate/Green matt/  
Vert mat/Verde mate



2500x90cm



Rollo 25m

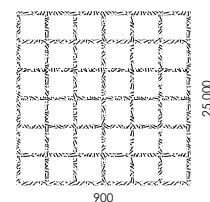

900

2500



# PVC Net

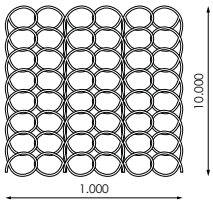
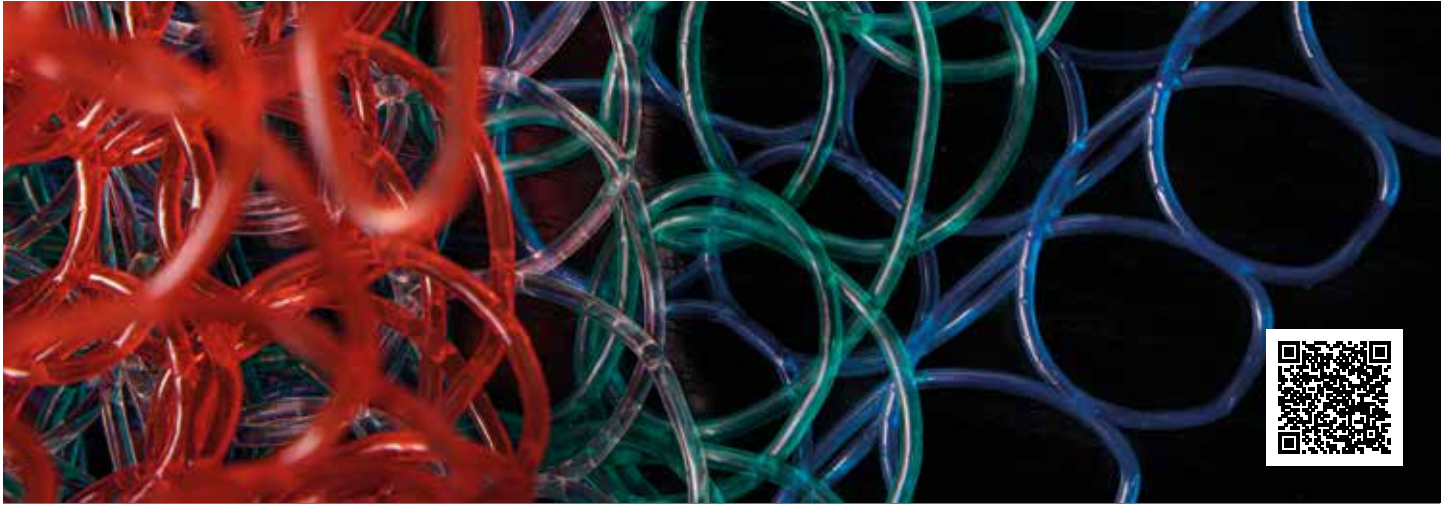

10x1m



Rollo 10m



442848

Transparente/Transparent/Transparent/Transparente

442855

Rojo/Red/Rouge/Vermelho

442862

Azul/Blue/Bleu/Azul

442879

Verde/Green/Vert/Verde

# PVC Net Glitter

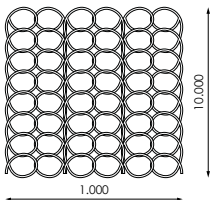
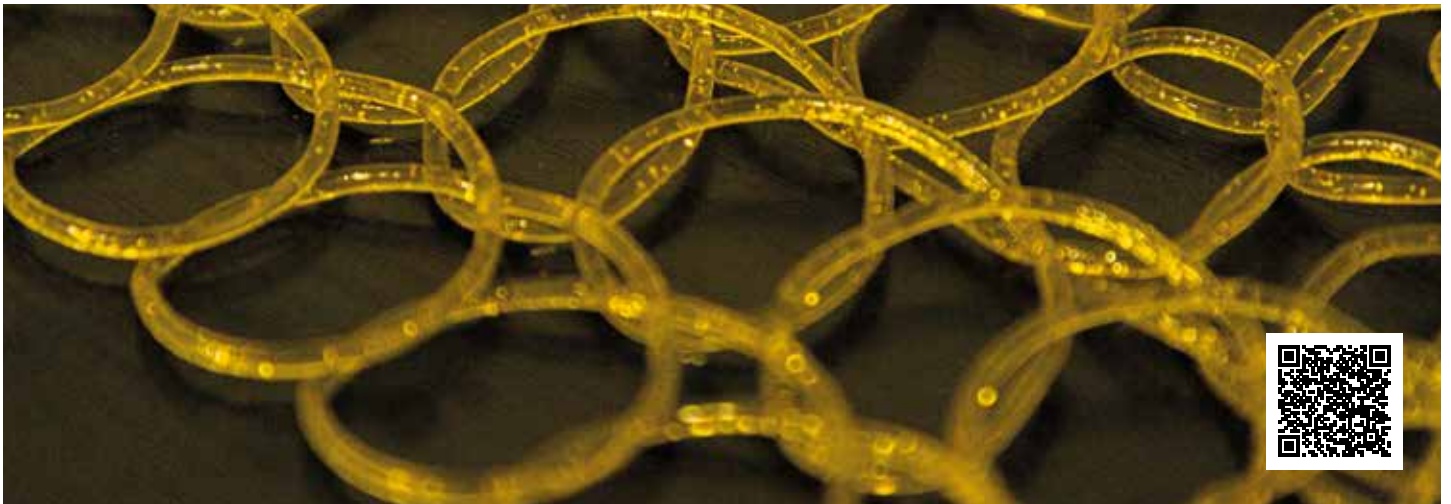

10x1m



Rollo 10m



442886

Dorado/Golden/D'or/Dourado

442893

Plata/Silver/Argent/Prata

# Fall Lite *LED*

Smart



⚡ 230V ac

Hz 50-60Hz

□ CII

⊙ IP44

⊗ NO INC.

⊕ 60ud



487498



60cm



144

W

1,5W



100pc

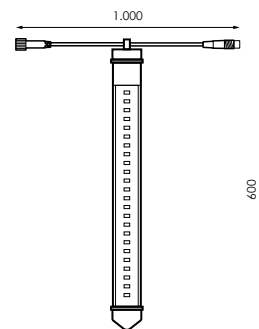

ESQUEMA INSTALACIÓN/  
INSTALLATION SCHEME/  
SCHEMA D'INSTALLATION/  
ESQUEMA DE  
INSTALAÇÃO



+

Producto/Product  
Produit/Produto

## Información/Information/Information/Informações

**N/** Este producto puede utilizar el cable de alimentación con o sin rectificador.

**E/** This product can use the power cord with or without a rectifier.

**F/** Ce produit peut utiliser le cordon d'alimentation avec ou sans redresseur.

**P/** Este produto pode usar o cabo de alimentação com ou sem um retificador.

Accesorios (NO Incluidos) / Accessoires (NOT Included) / Accessories (NON Inclus) / Acessórios (NÃO Incluso)





+ INFO PAG. 468

193078

Cable alimentación Blanco

# Fall Lite *LED*

Smart

	230V ac
<b>Hz</b>	50-60Hz
	CII
	IP44
	NO INC.
	25ud



Arcos Valdevez  
Portugal

[GRÁFICOS: Unidades en mm/ GRAPPHICS: Units in mm/GRAPHIQUES: Unités en mm/GRÁFICOS: Unidades em mm]

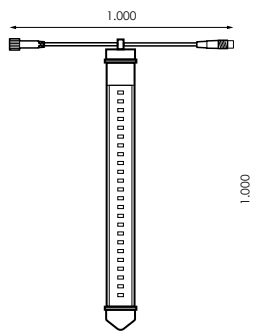







ESQUEMA INSTALACIÓN/  
INSTALLATION SCHEME/  
SCHEMA D'INSTALLATION/  
ESQUEMA DE  
INSTALAÇÃO



+

Producto/Product  
Produit/Produto

	100cm
	192
<b>W</b>	3W
	100pc

	
487504	

## Información/Information/Information/Informações

**N/** Este producto puede utilizar el cable de alimentación con o sin rectificador.

**E/** This product can use the power cord with or without a rectifier.

**F/** Ce produit peut utiliser le cordon d'alimentation avec ou sans redresseur.

**P/** Este produto pode usar o cabo de alimentação com ou sem um retificador.

Accesorios (NO Incluidos) / Accessoires (NOT Included) / Accessories (NON Inclus) / Acessórios (NÃO Incluso)

+ INFO PAG. 468

193078

Cable alimentación Blanco



# Fall Lite *LED*

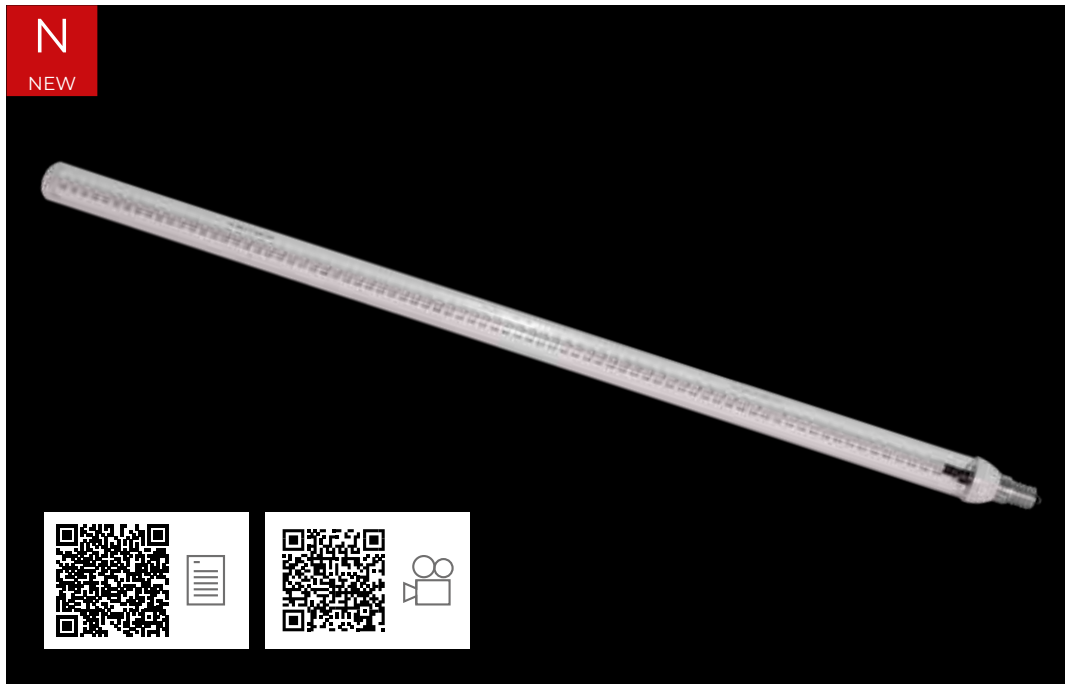

⚡ 230V

Hz 50-60Hz

°° IP44

📦 10ud

Ñ/ Para portalámparas estanco. **E/**For waterproof lampholder. **F/** Pour la douille imperméable à l'eau. **P/** Para portalâmpada impermeável.

391450	
543040	

↔	20cm
W	1W
	E14

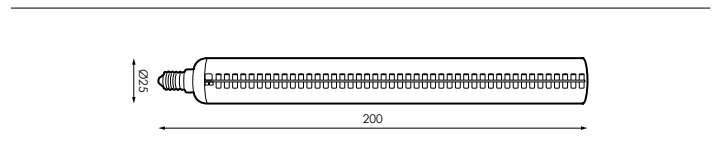

N 588973*	

↔	22cm
W	3W
	E14

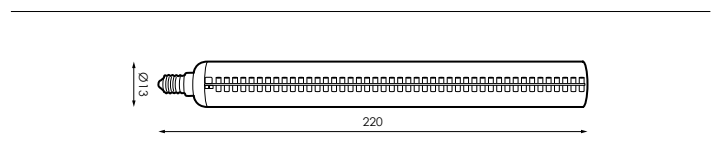

512916*	
543057	

↔	60cm
W	2W
	E14

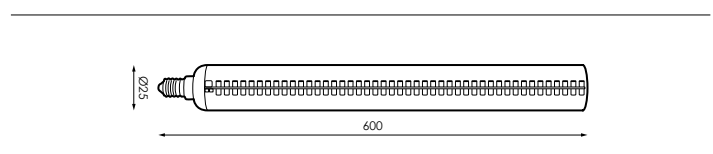

391474	
543064	

↔	100cm
W	4W
	E14

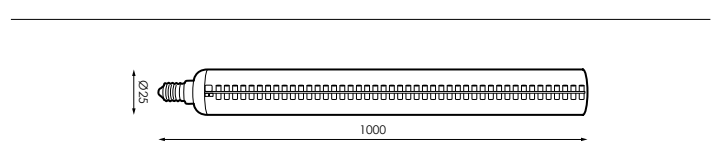

## Información/Information/Information/Informações

Ñ/ \* Este producto lleva LEDs SMD.

E/ \* This product carries SMD LEDs.

F/ \* Ce produit est équipé de LED SMD.

P/ \* Este produto possui LEDs SMD.

# esSENSE BALL LED

⚡ 230V ac

Hz 50-60Hz

⦿ IP44

📦 10/100

Ñ/ Para portalámparas estanco. **E/**For waterproof lampholder. **F/** Pour la douille imperméable à l'eau. **P/** Para portalâmpada impermeável.

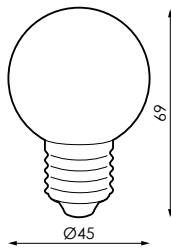

W 1,5W

🔌 E27



391276 \*

391269 \*



# esSENSE BALL LED

⚡ 230V ac

Hz 50-60Hz

⦿ IP44

📦 100ud

Ñ/ Para portalámparas estanco. **E/**For waterproof lampholder. **F/** Pour la douille imperméable à l'eau. **P/** Para portalâmpada impermeável.

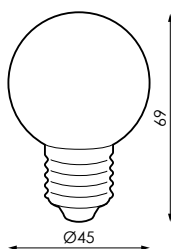

W 1,6W

🔌 E27



561235

561228

N 590761

N 590754

N 590785

N 590778



[GRÁFICOS: Unidades en mm/ GRÁFICOS: Units in mm/ GRAPHICS: Units in mm/ GRÁFICOS: Unidades em mm/ GRÁFICOS: Unidades em mm]

\*Hasta fin de existencias/\* Until end of stock/\* Jusqu'à épuisement des stocks/\* Enquanto os estoques durarem

# Pebetero *LED*



⚡ 230V ac

Hz 50-60Hz

°° IP44

🔌 100ud

Ñ/ Para portalámparas estanco. **E**/For waterproof lampholder. **F**/ Pour la douille imperméable à l'eau. **P**/ Para portalâmpada impermeável.



391214 \*



391238 \*



W 1W

🔌 E14

Cristal transparente.  
Transparent glass.  
Verre transparent.  
Vidro transparente.

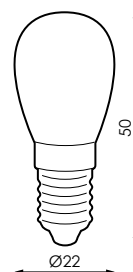

# Pebetero *LED*



⚡ 230V ac

Hz 50-60Hz

°° IP44

🔌 100ud

Ñ/ Para portalámparas estanco. **E**/For waterproof lampholder. **F**/ Pour la douille imperméable à l'eau. **P**/ Para portalâmpada impermeável.



561174



561181



561198



561204



561211



563710



W 1,5W

🔌 E14

Cristal transparente.  
Transparent glass.  
Verre transparent.  
Vidro transparente.

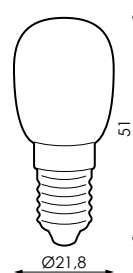





**Ciudad de Braga 2020**  
by AM Illumination  
Producto Prilux

# esSENSE Ball *LED*

basic



⚡ 230V

Hz 50-60Hz

°° IP44

⊞ 10/100

Ñ/ Para portalámparas estanco. **E**/For waterproof lampholder. **F**/ Pour la douille imperméable à l'eau. **P**/ Para portalâmpada impermeável.



961240\*



W 1,5W

⊞ E27

\*Cambio de color sincronizado entre lámparas.  
\*Change of color sync between lamps.  
\*Changement de synchronisation de couleur entre les lampes.  
\*Mudança de sincronização de cor entre lâmpadas.

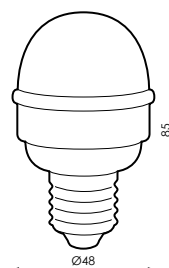

# Flash Light *LED*



⚡ 230V

Hz 50-60Hz

°° IP44

⊞ 100ud

Ñ/ Para portalámparas estanco. **E**/For waterproof lampholder. **F**/ Pour la douille imperméable à l'eau. **P**/ Para portalâmpada impermeável.



389884



E14

389907



E27

389891



B22

W 3W

⊞ 36

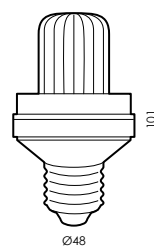



# Standard

## Incandescencia

⚡ 230V ac

Hz 50-60Hz

°° IP44

⊞ 100ud

Ñ/ Para portalámparas estanco. **E**/For waterproof lampholder. **F**/ Pour la douille imperméable à l'eau. **P**/ Para portalâmpada impermeável.

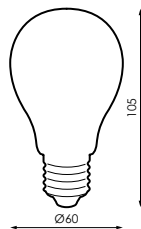

W 15W



⊞ E27

012652\* 





# String Flash



	230V dc
	50-60Hz
	CII
	IP44
	-20°C~+60 °C
	NO INC.
	20ud

146579		
146586		

	3m
	3
W	2,4W
	10sets

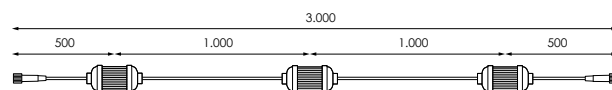

ESQUEMA INSTALACIÓN/  
INSTALLATION SCHEME/  
SCHEMA D'INSTALLATION/  
ESQUEMA DE  
INSTALAÇÃO



+

Producto/Product  
Produit/Produto

Accesorios (NO Incluidos) / Accessoires (NOT Included) / Accessories (NON Inclus) / Acessórios (NÃO Incluso)

+ INFO PAG. 468

995092

Cable alimentación Negro

977722

Cable alimentación Blanco

Prilux eConcept

**PRILUX**  
eConcept

Iluminación Decorativa  
BODAS - EVENTOS - TERRAZAS

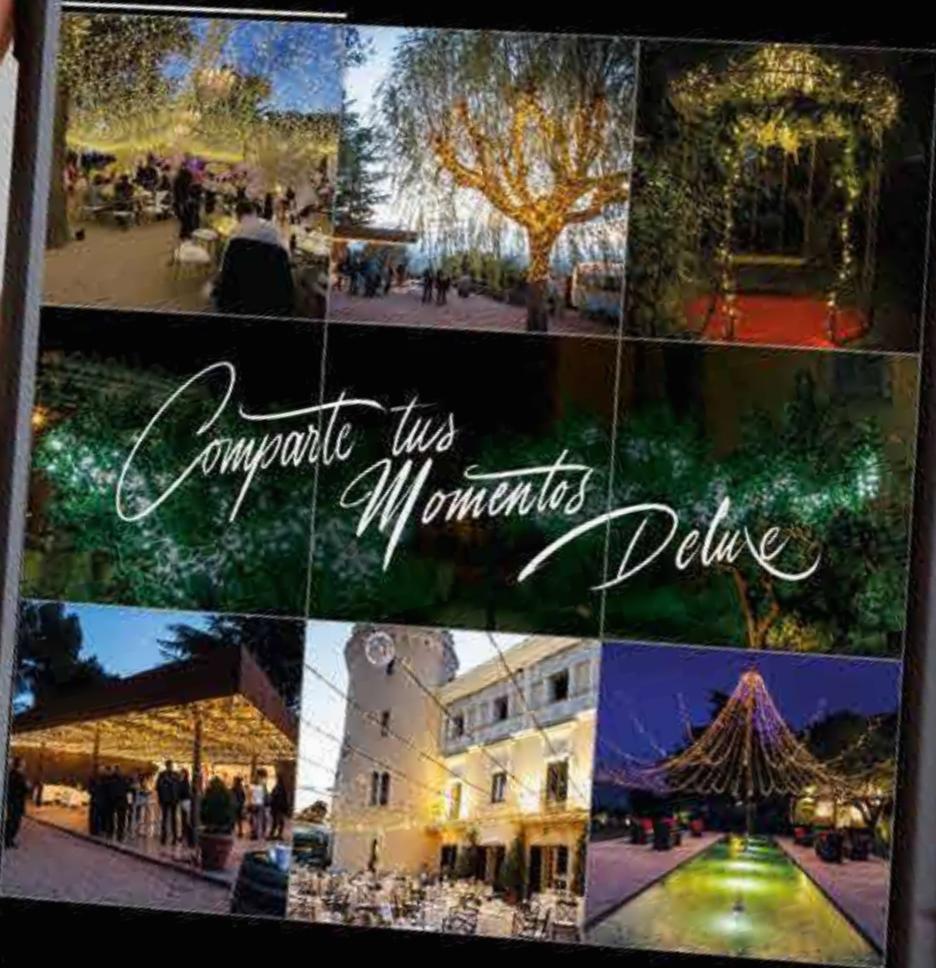

+info



# Stalactite Garland

E27



**N**  
NEW

	230V
	50-60Hz
	CII
	IP44
	NO INC.
	1ud

600057	

	100m
	Máx. 3.105W
	Máx. 13,5A

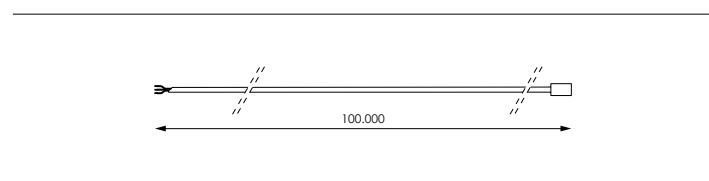

Accesorios (NO Incluidos) / Accessoires (NOT Included) / Accessories (NON Inclus)/ Acessórios (NÃO Incluso)

600088	

	25,5cm
	Máx. 15W
	E27

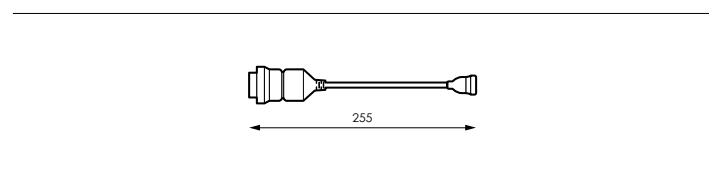

600095	



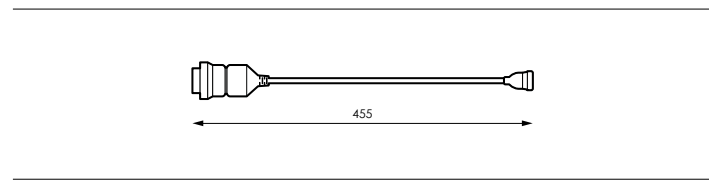

	45,5cm
	Máx. 15W
	E27





# Stalactite Garland

E27

	230V
<b>Hz</b>	50-60Hz
	CII
	IP44
	NO INC.
	1ud

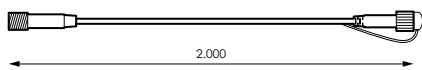

2.000



2m

W

Máx. 3.105W



Máx. 13,5A



600064

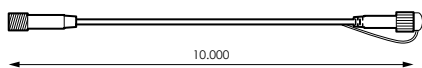

10.000



10m

W

Máx. 3.105W



Máx. 13,5A



600071



## Accesorios (NO Incluidos) / Accessoires (NOT Included) / Accessories (NON Inclus) / Acessórios (NÃO Incluso)

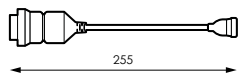

255



25,5cm

W

Máx. 15W



E27



600088

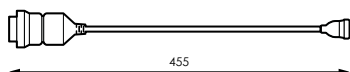

455



45,5cm

W

Máx. 15W



E27



600095

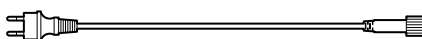

2m



600101



# Guirnalda E14

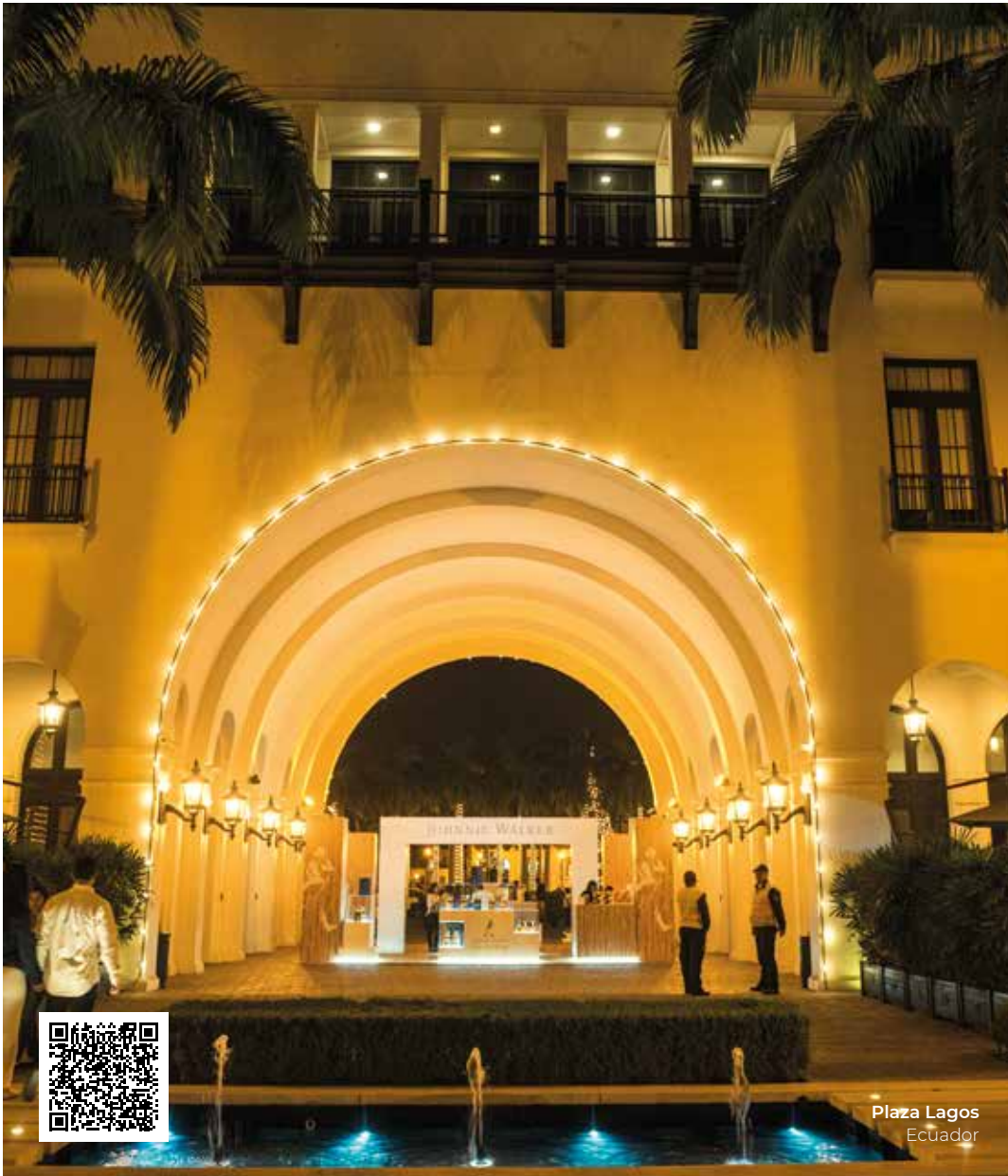

⚡ 230V dc

Hz 50-60Hz

☐ CII

⊙ IP44

⚡ INC.

⊕ 1ud



Plaza Lagos  
Ecuador

	⊙
392105	☀

↔	15m
W	20W
⊕	60

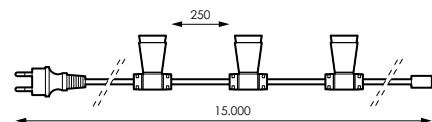

	⊙
392112	☀

↔	50m
W	5W
⊕	200

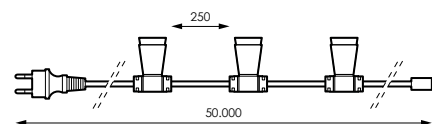

# Guirnalda E27

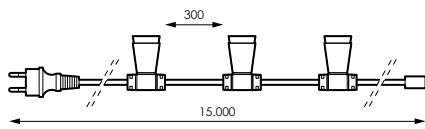

↔ 15m



W/ 20W

392075



45

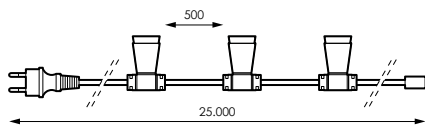

↔ 25m



W/ 20W

446433



50

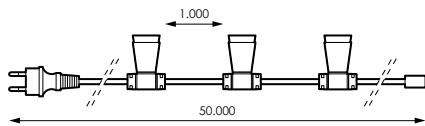

↔ 50m



W/ 20W

446440



50

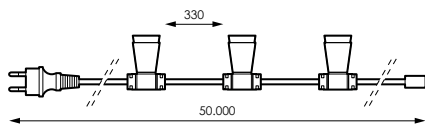

↔ 50m



W/ 5W

392082



150

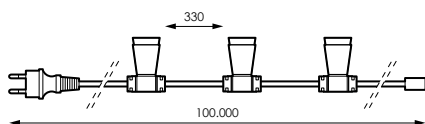

↔ 100m



W/ 2W

392099



300



# Accesorios (NO Incluidos)

Accessoires (NOT Included)

Accessories (NON Inclus)

Acessórios (NÃO Incluso)

		Cluster Shop Microled	ICICLE# Microled	Led Fireworks	Willow Light	Led Fountain	Fall Lite Led Smart	Snowlite Led	String Flash	Smart 20 Light	Fall Lite Led	Essense Led	Pebetero Led	Flash Light Led
⚡	149181			•										
	149198			•										
	149204			•										
	149211			•										
	193061						•			•				
	193078						•	•		•				
	444446	•	•											
	977722						•		•					
	995092						•		•					
	⌚	146623											•	
192316												•		•
391511											•		•	•
391528											•		•	•
447720			•										•	•
←	401371					•								
	401388				•									

TRANSFORMADOR MICROLED

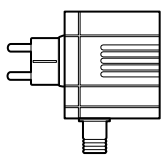

TR

⚡	⚡	W	⚡
444446	24V	Máx. 25W	IP20

EXTENSIÓN MICROLED

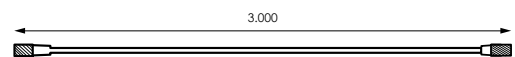

⚡	↔	⊗	⊠	⚡
447720	3m	□	CII	IP20

SOPORTE PARED WILLOW LIGHT

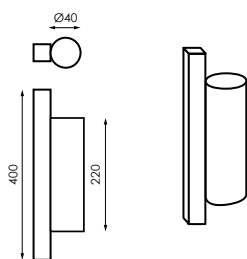

⚡	⊗	🏠	🏠
401388	□	INT.	EXT.

SOPORTE PARED LED FOUNTAIN

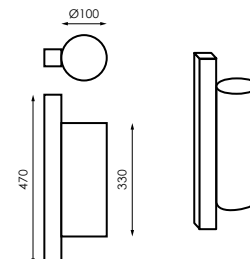

⚡	⊗	🏠	🏠
401371	□	INT.	EXT.

TRANSFORMADOR 24V

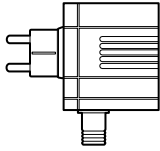

TR		W	
	149181	Máx. 10,8W	Sin rectificador Without rectifier Sans redresseur Sem retificador

TRANSFORMADOR 24V

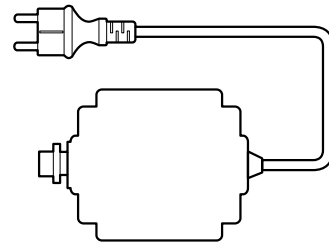

TR		W	
	149198	Máx. 28,8W	Sin rectificador Without rectifier Sans redresseur Sem retificador

TRANSFORMADOR 24V

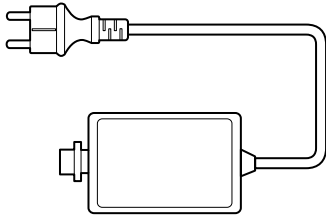

TR		W	
	149204	Max. 60W	Sin rectificador Without rectifier Sans redresseur Sem retificador

TRANSFORMADOR 24V

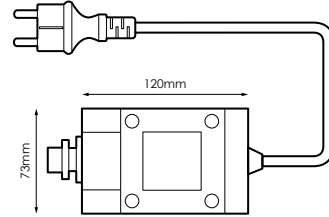

TR		W	
	149211	Max. 120W	Sin rectificador Without rectifier Sans redresseur Sem retificador

CABLE ALIMENTACIÓN SMART LINK

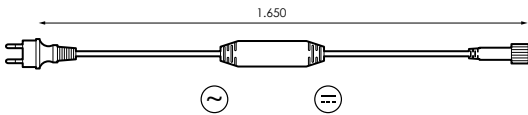

UR		⊕	⚡	W	□	⊙
	995092	230Vac	Max. 480W	CII	IP44 Plug IP65 Conector	
	977722	230Vac	Max. 480W	CII	IP44 Plug IP65 Conector	

CABLE ALIMENTACIÓN SMART LINK

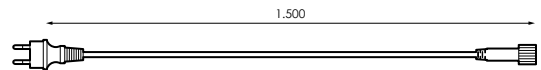

UR		⊕	⚡	W	□	⊙
	193061	230Vac	Max. 480W	CII	IP44 Plug IP65 Conector	
	193078	230Vac	Max. 480W	CII	IP44 Plug IP65 Conector	

SMART E27/E14 SMART LINK

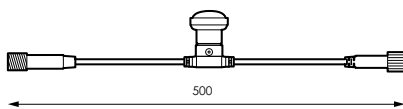

	⊕	⊙
391528	E14	⊙
391511	E14	⊙
192316	E27	⊙
146623	E27	⊙





Anexos  
Annexes  
Annexes  
Anexos

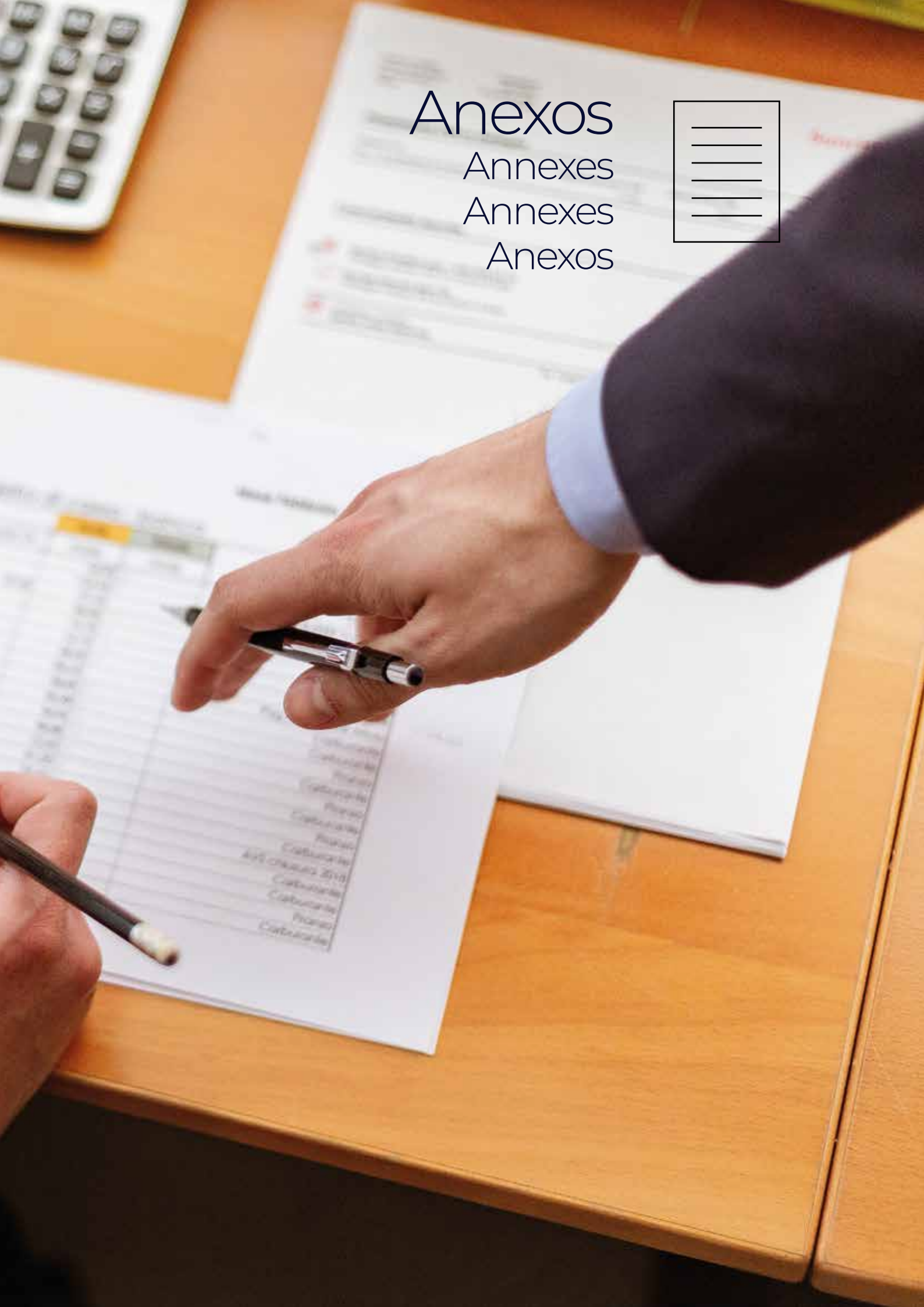

# Reparación tramo Flexilight

Repair of the Flexilight segment

Réparation du segment Flexilight

Reparação do segmento Flexilight

1

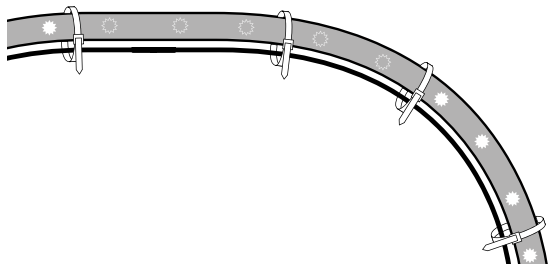

2

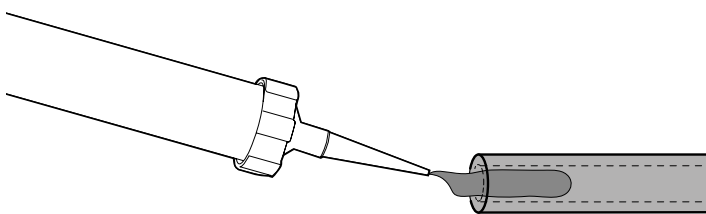

3

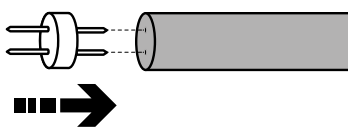

Ñ/ ASEGÚRESE DE QUE LA POLARIDAD Y EL SENTIDO DE LA CORRIENTE SON LOS CORRECTOS.

F/ ASSUREZ-VOUS QUE LA POLARITÉ ET LA DIRECTION DE LA PUISSANCE SONT CORRECT.

E/ MAKE SURE THAT THE POLARITY AND THE POWER DIRECTION ARE CORRECT.

P/ CERTIFIQUE QUE A POLARIDADE E A DIREÇÃO DA CORRENTE SÃO CORRETAS.

4

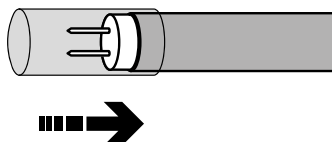

5

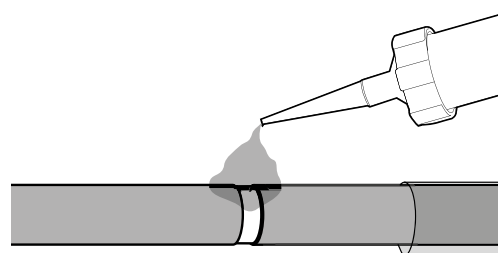
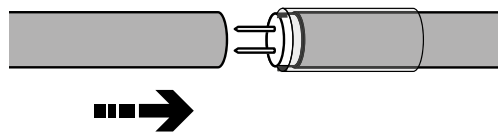

6

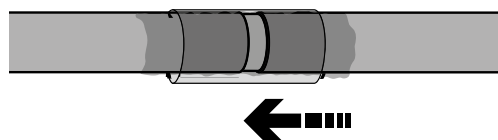

7

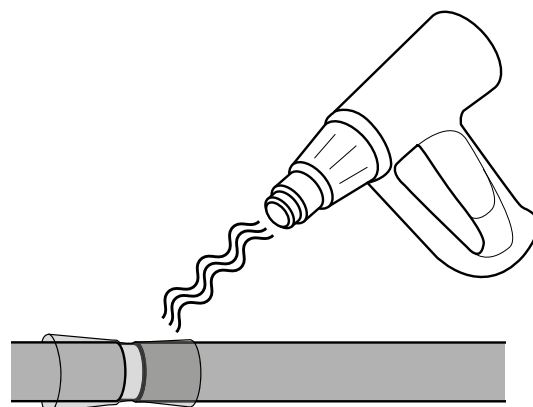

8



9

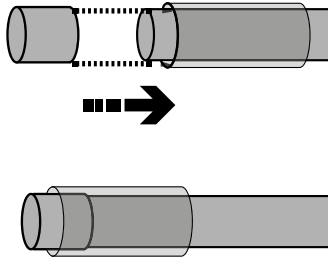

10

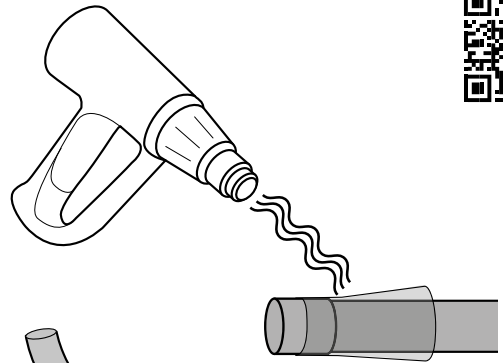

11



12

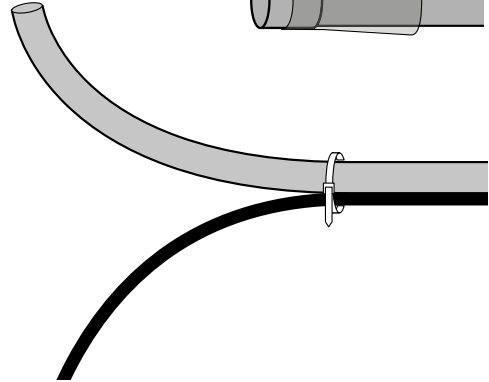

**FIG.1** Localice el tramo de hilo a reparar y elimínelo.

**FIG.2** Corte un tramo de hilo nuevo y selle los orificios internos de ambos extremos con 2 o 3cm de silicona.

**FIG.3** Inserte un conector introduciendo las patillas metálicas a través de los orificios de los cables metálicos del interior del hilo.

**FIG.4** Introduzca el termorretráctil por uno de los extremos del hilo para su posterior sellado.

**FIG.5** Proceda a unir los dos extremos del hilo mediante el conector rellenando el orificio con 2cm de silicona.

**Una vez unidos los dos extremos aplique y extienda silicona sobre la unión y parte del hilo.**

**FIG.6** Coloque el termorretráctil sobre la junta de los dos tramos de hilo.

**FIG.7/8** Selle la junta calentando el termorretráctil.

**FIG.9/10/11** Repita este proceso en los extremos de los tramos a sustituir colocando un tapón para rematar los tramos finales del hilo. No olvide rellenar los orificios con silicona.

**FIG.12** Fije los tramos de hilo a la estructura del motivo.

**FIG.1** Locate the section to repair.

**FIG. 2** Cut a piece of new wire and seal the ends with silicone.

**FIG.3** Insert a new connector metal entering through wire pin inside the holes of the internal wires.

**FIG.4** Enter a shrink in the wire's side for its subsequent sealing.

**FIG.5** Proceed to join the two ends of the wire through the connector. **Then extend and apply silicone on the union and part of the wire.**

**FIG. 6** Introduce the shrink on the joint of the two wire's sections.

**FIG.7/8** Seal the seam by heating the shrinkable.

**FIG.9/10/11** Repeat this process at the ends of every sections to be replaced.

**FIG.12** Set the new sections to the metallic structure.

**FIG.1** Localisez la section de fil de réparation.

**FIG.2** Coupez un morceau de fil de fer. Sceller les extrémités avec du silicone.

**FIG.3** Insérer un nouveau connecteur métal entrant dans les trous des fils métalliques dans l'axe du fil.

**FIG.4** Entrez un psy par une extrémité du fil pour la fermeture ultérieure.

**FIG.5** Passez à joindre les deux extrémités du fil à travers le connecteur.

**Une fois que les deux extrémités ensemble et étendre appliquer silicone sur l'union et une partie du fil.**

**FIG.6** Introduire le psy sur le plateau des deux sections de fil.

**FIG.7/8** Sceller le joint en chauffant le psy.

**FIG.9/10/11** Répétez ce processus sur les extrémités des sections à remplacer.

**FIG.12** Set mèches la structure du moyen.

**FIG.1** Localize a seção de rosca.

**FIG.2** Corte um pedaço de arame e selar as extremidades com silicone.

**FIG.3** Inserir um novo conector de metal que entra através dos orificios dos fios de metal do pino de arame. Uma extremidade do fio para vedação posterior.

**FIG.5** Unir as duas extremidades do fio através do conector. **Uma vez que as duas pontas e estender aplicar silicone na união e parte da discussão.**

**FIG.6** Introduzir o termorretráctil no quadro das duas seções de fio.

**FIG. 7/8** Selar a costura por aquecimento do termorretráctil.

**FIG.9/10/11** Repita este processo as extremidades das seções.

**FIG. 11/12** Set vagueia a estrutura do fundamento.

## Ñ/ Recomendación

Se recomienda la revisión de todas las conexiones y empalmes de los motivos y productos de Navidad antes y después de su puesta en funcionamiento en cada campaña para evitar la dilatación de juntas y condensaciones.

Se recomienda NO dejar expuesto a la intemperie el hilo luminoso más de un año para evitar su degradación por los rayos ultravioletas del sol.

Es recomendable la desinstalación del producto al finalizar cada campaña.

## E/ Recommendation

Reviewing all connections and splices motives and Christmas products is recommended before and after their operation in each campaign to prevent condensation and expansion joints.

It is recommended NOT expose to weather the bright thread over a year to prevent degradation by ultraviolet rays.

We recommend uninstalling the product at the end of each campaign.

## F/ Recommandatio

Revoir toutes les connexions et raccords de motifs et de produits de Noël est recommandé avant et après leur opération dans chaque campagne pour éviter la condensation et les joints de dilatation.

Il est recommandé de ne pas exposer aux intempéries le fil lumineux plus d'un an pour éviter degradation par les rayons ultraviolets.

Nous recommandons de désinstaller le produit à la fin de chaque campagne.

## P/ Recomendação

Rever todas as conexões e emendas motivos e produtos de Natal é recomendada antes e após a sua operação em cada campanha para evitar a condensação e expansão articulações.

Recomenda-se não expor para enfrentar a linha brilhante ao longo de um ano para evitar degradation pelos raios ultravioleta.

Recomendamos desinstalar o produto, no final de cada campanha.



# Reparación cable alimentación

Repair of the power cable

Réparation du câble d'alimentation

Reparação do cabo de alimentação

1



2

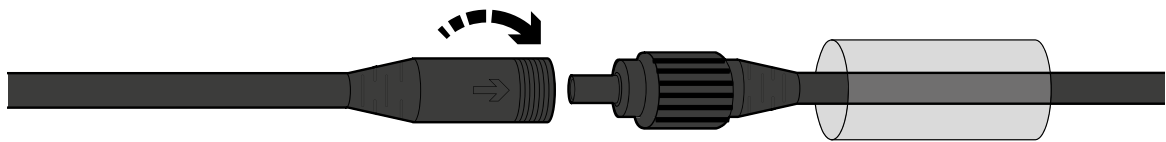

3

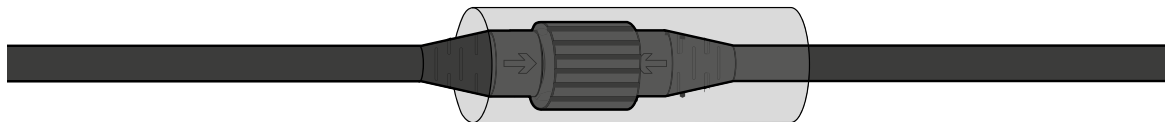

4

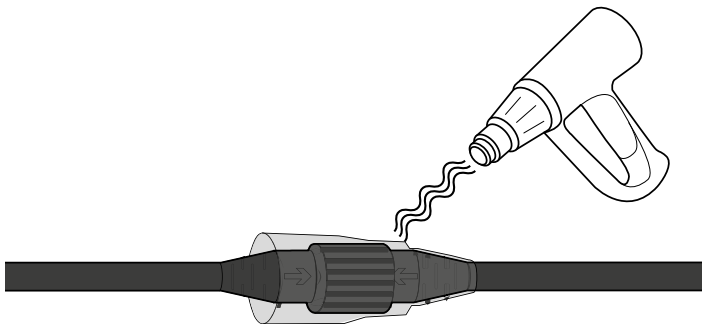

5

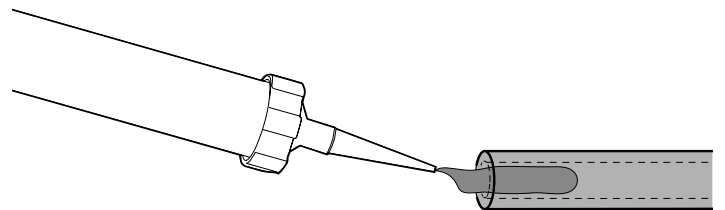

6

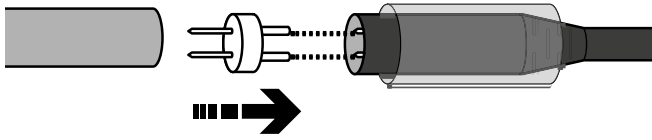

**Ñ/ ASEGÚRESE DE QUE LA POLARIDAD Y EL SENTIDO DE LA CORRIENTE SON LOS CORRECTOS.**

**E/ MAKE SURE THAT THE POLARITY AND THE POWER DIRECTION ARE CORRECT.**

**F/ ASSUREZ-VOUS QUE LA POLARITÉ ET LA DIRECTION DE LA PUISSANCE SONT CORRECT.**

**P/ CERTIFIQUE QUE A POLARIDADE E A DIREÇÃO DA CORRENTE SÃO CORRETAS.**



7

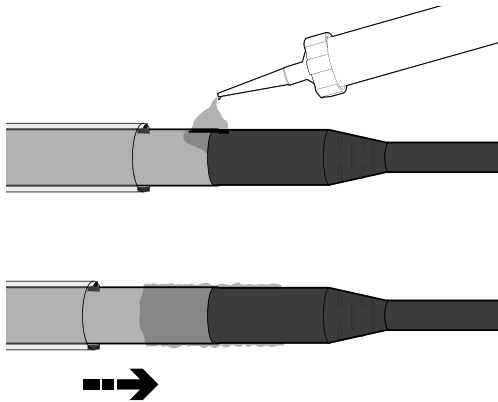

**FIG.1** Proceda a unir el cable de alimentación o en el empalme estanco insertando previamente el termorretráctil en uno de los dos elementos.  
**FIG.2** Conecte las clavijas del cable de alimentación y el empalme estanco, roscando la tapa posteriormente.  
**FIG.3** Coloque el termorretráctil sobre la unión de los dos elementos.  
**FIG.4** Caliente el termorretráctil para sellar la junta.  
**FIG.5** Rellene los orificios internos del extremo del hilo con 2 o 3cm de silicona.  
**FIG.6** Proceda realizar la unión entre cable de alimentación e hilo insertando el conector adecuado entre ambos elementos. Previamente debe introducirse un termorretráctil para su posterior sellado.  
**FIG.7 Una vez unidos los dos extremos aplique y extienda silicona sobre la unión y parte del hilo.**  
**FIG.8** Coloque el termorretráctil sobre la unión de los elementos y aplique calor para su correcto sellado.

**FIG.1** Proceed to attach the power cable or by inserting the previously sealed shrink splice in one of the two elements.  
**FIG.2** Connect the power cord plugs and tight fitting, screwing the lid later.  
**FIG.3** Place the heat shrink over the joint of the two elements.  
**FIG.4** Heat shrink to seal the joint.  
**FIG.5** Seal the ends with silicone.  
**FIG.6** Proceed to perform the union between power cord and thread inserting the appropriate connector between the two. Formerly must enter a shrink for sealing later.  
**FIG.7 Then extend and apply silicone on the union and part of the wire.**  
**FIG.8** Place the shrink over the joint elements and apply heat for proper sealing.

8

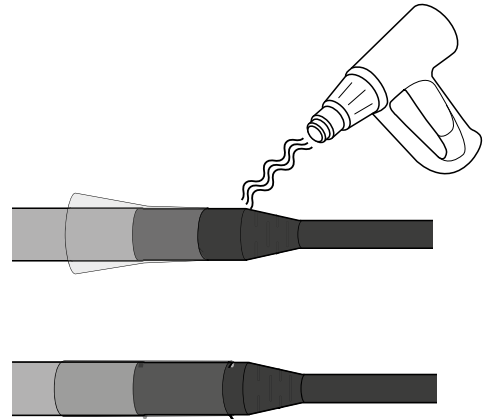

**FIG.1** Procéder à brancher le câble d'alimentation ou par l'insertion, jonction rétractable déjà scellé dans l'un des deux éléments.  
**FIG.2** Branchez les fiches du cordon d'alimentation et bien ajusté, de visser le couvercle plus tard.  
**FIG.3** Placez le rétrécissement de la chaleur sur le joint des deux éléments.  
**FIG.4** Thermorétractables l'étanchéité du joint.  
**FIG.5** Sceller le extrémité avec du silicone.  
**FIG.6** Passez à effectuer l'union entre le cordon d'alimentation et du fil de brancher le connecteur approprié entre les deux. (Anciennement doit entrer un psy pour fermer ultérieurement.  
**FIG.7** Une fois que les deux extrémités ensemble et étendre appliquer silicone sur l'union et une partie du fil.  
**FIG.8** Placez le rétrécissement de la chaleur sur les éléments communs et appliquer de la chaleur pour une bonne étanchéité.

**FIG.1** Continuar para prender o cabo de energia ou por inserção da emenda de retracção previamente seladas em um dos dois elementos.  
**FIG.2** Ligue as fichas do cabo de alimentação e apertadas, enroscando a tampa posterior.  
**FIG.3** Coloque o calor encolher sobre a articulação dos dois elementos.  
**FIG.4** Dissipadores de calor para selar a junta.  
**FIG.5** Selar a extremidade com silicone.  
**FIG.6** Continuar para realizar a união entre o cabo de alimentação e de inserir o fio de ligação adequada entre os dois. Anteriormente deve digitar um termorretráctil para selar mais tarde.  
**FIG.7** Uma vez que as duas pontas e estender aplicar silicone na união e parte da discussão.  
**FIG.7/8** Coloque o calor encolher ao longo dos elementos comuns e aplicar calor para vedação adequada.

## Ñ/ Recomendación

Se recomienda la revisión de todas las conexiones y empalmes de los motivos y productos de Navidad antes y después de su puesta en funcionamiento en cada campaña para evitar la dilatación de juntas y condensaciones.

Se recomienda NO dejar expuesto a la intemperie el hilo luminoso más de un año para evitar su degradación por los rayos ultravioletas del sol.

Es recomendable la desinstalación del producto al finalizar cada campaña.

## E/ Recommendation

Reviewing all connections and splices motives and Christmas products is recommended before and after their operation in each campaign to prevent condensation and expansion joints.

It is recommended NOT expose to weather the bright thread over a year to prevent degradación by ultraviolet rays.

We recommend uninstalling the product at the end of each campaign.

## F/ Recommendation

Revoir toutes les connexions et raccords de motifs et de produits de Noël est recommandé avant et après leur opération dans chaque campagne pour éviter la condensation et les joints de dilatation.

Il est recommandé de ne pas exposer aux intempéries le fil lumineux plus d'un an pour éviter degradación par les rayons ultraviolets.

Nous recommandons de désinstaller le produit à la fin de chaque campagne.

## P/ Recomendação

Rever todas as conexões e emendas motivos e produtos de Natal é recomendada antes e após a sua operação em cada campanha para evitar a condensação e expansão articulações.

Recomenda-se não expor para enfrentar a linha brilhante ao longo de um ano para evitar degradación pelos raios ultravioleta.

Recomendamos desinstalar o produto, no final de cada campanha.

## Certificaciones

Certifications

Certifications

Certificações



SGS ISO 9001



SGS ISO 14001



SGS ISO 45001



SGS ISO 50001

## Condiciones de Uso

Terms of use

Condition d'utilisation

Condições de uso

## Condiciones de Garantía

Warranty Conditions

Conditions de garantie

Condições de garantia

## Condiciones de Venta



















Terms of sale



















Conditions de vente

Condições de venda























































	ESPAÑOL (Ñ)	ENGLISH (E)	FRANÇAIS (F)	PORTUGUÊS (P)
	Código	Code	Code	Código
	Código izquierda	Left code	Code gauche	Código esquerdo
	Código derecha	Right code	Code droite	Código direito
<b>W</b>	Consumo total (W)	Consumption (W)	Consommation (W)	Consumo (W)
	Modelo	Model	Modèle	Modelo
	Tensión (V)	Voltage (V)	Tension D` Alimentation (V)	Tensão (V)
<b>Hz</b>	Frecuencia (Hz)	Frequency (Hz)	Fréquence (Hz)	Frequência (Hz)
	Clase I Aislamiento eléctrico	Class I Electrical isolation	Classe I Isolation électrique	Classe I Isolamento elétrico
	Clase II Aislamiento eléctrico	Class II Electrical isolation	Classe II Isolation électrique	Classe II Isolamento elétrico
	Clase III Aislamiento eléctrico	Class III Electrical isolation	Classe III Isolation électrique	Classe III Isolamento elétrico
	IP Índice de estanqueidad	IP Sealing rating	IP Indice d`etanchéité	IP Índice de estanqueidade
	Temperatura de funcionamiento	Operating temperature	Température de service	Temperatura de trabalho
	Canal/Vías	Canal/Ways	Canal/Voies	Canal/Circuitos
	Ángulo de apertura	Opening angle	Angle d`ouverture	Ângulo de abertura
	Número de led	LED number	Nombre de led	Número de led
	Fuente de luz	Light source	Source de lumière	Fonte de luz
	Horas por carga	Hours per charge	Heures par charge	Horas por carga
	Color cuerpo	Body colour	Couleur du corps	Cor do corpo
	Color led	Led colour	Couleur led	Cor led
	Color contorno (1, 2, 3,...)	Contour colour (1, 2, 3,...)	Couleur de contour (1, 2, 3,...)	Cor de contorno (1, 2, 3,...)
	Color relleno (1, 2, 3,...)	Colour fill (1, 2, 3,...)	Remplissage de couleur (1, 2, 3,...)	Preenchimento de cor (1, 2, 3,...)
	Peso	Weight	Poids	Peso
	Longitud	Lenght	Longueur	Comprimento
	Dimensiones	Measures	Dimensions	Dimensão
	Cuerpo	Body	Corps	Corpo

	ESPAÑOL (Ñ)	ENGLISH (E)	FRANÇAIS (F)	PORTUGUÊS (P)
	Marco	Frame	Cadre	Quadro
	Consumo/Corte	Consumption/Cut	Consommation/Couper	Consumo/Corte
	Corte tira	Strip cut	Coupe bande	Corte tira
	Tapa inicio/Tapa final	Start cover / End cover	Capot de début / Capot de fin	Tampa inicial / Tampa final
	Unión	Union	Union	União
	Rollo	Roll	Rouleau	Rolo
	Consumo/Segmento	Consumption/Segment	Consumption/Segment	Consumo/Segmento
	Segmento	Segment	Segment	Segmento
	Número de segmentos	Number of segments	Nombre de segments	Número de segmentos
	Número de led/Segmento	LED number/Segment	Nombre de led/Segment	Número de led/Segmento
	Consumo/Portalámparas	Consumption/Lamp holder	Consommation/Douille	Consumo/Lâmpada
	Portalámparas	Lamp holder	Douille	Lâmpada
	Número de tiras	Number of strips	Nombre de bandes	Número de tiras
	Led/Tiras	Led/Strips	Led/Bandes	Led/Tiras
	Producto para suspender	Product to suspend	Produit à suspendre	Produto para suspender
	Embalaje	Packaging	Emballage	Embalagem
	Unidad/Embalaje	Unit/Packaging	Unité/Emballage	Unidade/Embalagem
	Diámetro	Diameter	Diamètre	Diâmetro
	Datos panel solar	Solar panel data	Données de panneau solaire	Dados do painel solar
	Datos batería	Battery data	Données de la batterie	Dados da bateria
	Número de bolas	Number of balls	Nombre de balles	Número de bolas
	Empalmable	Linkable	Empalmable	Pode ampliar
	NO Empalmable	NO Empalmable	NO Empalmable	Não permite ampliar
	Cable alimentación NO incluido	Power cable NOT included	Câble d'alimentation NON inclus	Cabo de alimentação NÃO INCLuíDO
	Cable alimentación incluido	Power cable included	Câble d'alimentation inclus	Cabo de alimentação INCLuíDO

	ESPAÑOL (Ñ)	ENGLISH (E)	FRANÇAIS (F)	PORTUGUÊS (P)
	Control	Control	Contrôle	Controla
	Controlador NO incluido	Controller NOT included	Contrôleur NON inclus	Controlador NÃO INCLUÍDO
	Controlador incluido	Controller included	Contrôleur inclus	Controlador INCLUÍDO
	Transformador NO incluido	Transformer NOT included	Transformateur NON inclus	Transformador NÃO INCLUÍDO
	Transformador incluido	Transformer included	Transformateur inclus	Transformador INCLUÍDO
	Adaptador NO incluido	Adapter NOT included	Adaptateur NON inclus	Adaptador NÃO INCLUÍDO
	Adaptador incluido	Adapter included	Adaptateur inclus	Adaptador INCLUÍDO
	Rectificador NO incluido	Rectifier NOT included	Redresseur NON inclus	Retificador NÃO incluso
	Rectificador incluido	Rectifier included	Redresseur inclus	Retificador INCLUÍDO
	Fuente de alimentación NO incluida	Power supply NOT included	Alimentation NON inclus	Fonte de alimentação NÃO INCLUÍDA
	Extensión NO incluido	Extension NOT included	Extension NON inclus	Extensão NÃO INCLUÍDA
	Extensión incluido	Extension included	Extension inclus	Extensão INCLUÍDO
	Accesorios	Accessories	Accessoires	Acessórios
	Instalación rápida	Quick Install	Installation rapide	Instalação rápida
	Componentes	Components	Composants	Componentes
	Video demostrativo	Demonstration video	Vidéo de démonstration	Vídeo de demonstração
	Ficha Técnica	Data Sheet	Fiche Technique	Ficha Técnica
	Motivo Fachada	Motifs Facade	Motifs Façade	Motivo Fachada
	Motivo Farola	Motifs Streetlight	Motifs Lampadaire	Motivo Poste de luz
	Motivo Calle	Motifs Street	Motifs Rue	Motivo Rua
	Motivo de interior	Motifs inside	Motifs à l'intérieur	Motivo dentro
<b>3D</b>	Motivo 3D	Motifs 3D	Motifs 3D	Motivo 3D
	Motivo Mini	Motifs Mini	Motifs Mini	Motivo Mini



LED	MICRO	CABLE	PVC	ESPAÑOL (Ñ)	ENGLISH (E)	FRANÇAIS (F)	PORTUGUÊS (P)
-	-			Blanco	White	Blanc	Branco
-	-		-	Negro	Black	Noir	Preto
	-	-	-	Diamond (10.000K)	Diamond (10.000K)	Diamond (10.000K)	Diamond (10.000K)
	-	-	-	Blanco frío (8.000K)	Cool white (8.000K)	Blanc froid (8.000K)	Branco frio (8.000K)
	-	-	-	Blanco cálido (2.500K)	Warm white (2.500K)	Blanc chaud (2.500K)	Branco quente (2.500K)
	-	-	-	Blanco neutro (4.000K)	Neutral White (4.000K)	Blanc neutre (4.000K)	Branco neutro (4.000K)
-				Transparente	Transparent	Transparent	Transparente
				Azul	Blue	Bleu	Azul
	-	-	-	Verde manzana	Apple green	Vert pomme	Verde maçã
				Verde claro	Light green	Vert clair	Luz verde
-	-		-	Verde oscuro	Dark green	Vert foncé	Verde escuro
				Amarillo	Yellow	Jaune	Amarelo
	-	-	-	Amarillo intenso	Deep yellow	Jaune profond	Amarelo escuro
				Rojo	Red	Rouge	Vermelho
	-			Rosa	Pink	Rose	Rosa
-		-		Fucsia	Fuchsia	Fuchsia	Fúcsia
	-			Púrpura	Purple	Pourpre	Roxo
	-			Naranja	Orange	Orange	Laranja
	-		-	Dorado (2.000K)	Golden (2.000K)	D'or (2.000K)	Dourado (2.000K)
	-	-	-	Dual	Dual	Double	Duplo
	-	-	-	RGB	RGB	RVB	RGB
	-	-	-	RGBW	RGBW	RVBW	RGBW
	-	-	-	RGBWW	RGBWW	RVBWW	RGBWW
	-	-	-	CW-WW	CW-WW	CW-WW	CW-WW
	-	-	-	Multicolor	Multicolored	Multicolore	Multicolorido
	-	-	-	Flashing	Flashing	Clignotant	Piscando
	-	-	-	ALL Flashing	ALL Flashing	Tous Clignotant	Todos Piscando
	-	-	-	Sparkles	Sparkles	Sparkles	Sparkles

---

## GRUPO PRILUX ILUMINACIÓN S.L.U.

---

### SEDE CENTRAL

---

C/ Río Jarama nº 149.45007, Toledo (Spain).  
Tel.: 925 23 38 12 / Fax: 925 23 38 80

---

### DELEGACIÓN NORESTE

---

Carretera BV - 2249 Km 8  
08791, Sant Llorenç d'Hortons, Barcelona (Spain).

**Prilux eConcept** Tel.: (+34) 93 891 37 24

**Grupo Prilux Iluminación S.L.U** Tel: (+34) 93 719 23 29

---

[www.priluxeconcept.com](http://www.priluxeconcept.com)

---

---

### IMPRESIÓN

---

Junio 2022

---

### DISEÑO GRÁFICO

---

Departamento de Marketing

---

Pueden aparecer variaciones con respecto al color original debido a causas técnicas de la impresión.

Este catálogo actualiza los valores y características de las mismas luminarias que aparezcan en anteriores catálogos.

Los datos incluidos en este catálogo son correctos salvo error tipográfico.

Grupo Prilux Iluminación S.L.U. se reserva el derecho a cualquier modificación del producto sin previo aviso.

---

Web



**Tarifa**  
Price list  
Liste de prix  
Lista de preços



