

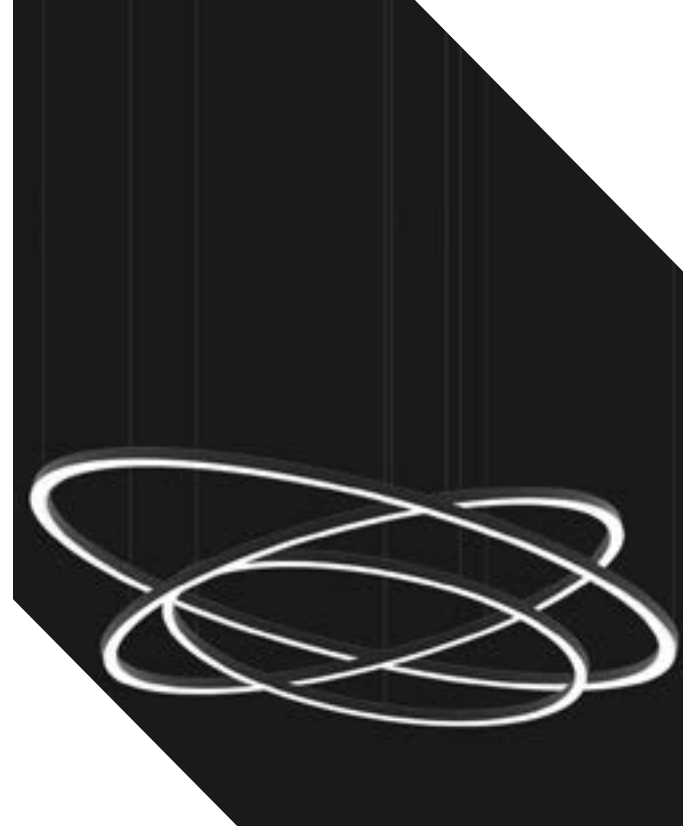

Let's get brighter

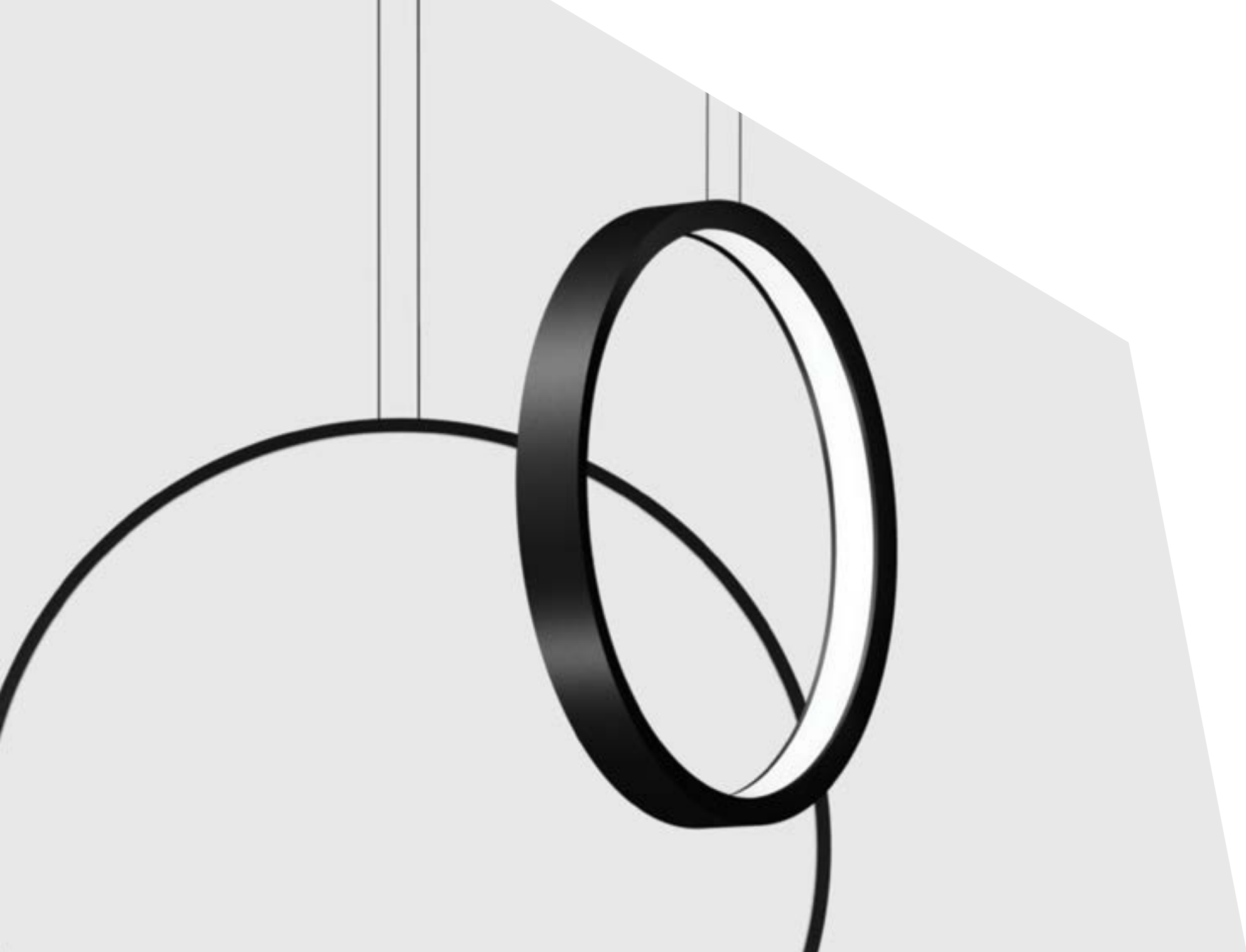

A re-set on principle.
Driven by a nonconformist spirit.

Updated references and new additions to our catalogue that cover global projects and unique collections such as Outdoor CEM and BPM Acoustic.

That's how we do things. There is no other option. Developing increasingly specialised products and more efficient solutions. So the future will always be brighter.

*Resetear por principios.
Por impulso y por espíritu
inconformista.*

*Referencias que se actualizan,
familias que se completan para
abarcas proyectos globales
y nuevas colecciones como
Outdoor CEM y BPM Acoustic
que se incorporan a nuestro
catálogo.*

*Ese es el camino. No hay otro.
Evolucionar en productos
cada vez más especializados
y en soluciones más eficientes.
El Futuro será, siempre, más
brillante.*

RE-SET

Bernardo Palomares



We have re-set and regrouped to continue as your lighting partner of choice. With a new brand image, updated virtual channels and a new catalogue concept that makes sure everyone is on the same page.

Sharing the creative process closely, co-creating and making it happen. Giving free rein to creativity, without limits, open to everyone's opinions and desires. At BPM Lighting, we know what we are doing, and the result is brilliant when we do it together. "Let's get brighter."

Reseteamos, reordenamos y estamos listos para seguir siendo su partner industrial de referencia. Imagen de marca renovada, nuestras ventanas virtuales actualizadas y un nuevo concepto de catálogo pensado para un trabajo conjunto más técnico y funcional.

Crear juntos, estar más cerca, compartir, cooperar, sumar. Dar rienda suelta a la creatividad, sin límites, abiertos a cualquier punto de vista. En BPM Lighting lo tenemos claro: Lo haremos juntos, y el resultado será brillante. "Let's get brighter".

RE-ADY



The idea and the result. And avant-garde technology at your service along the way. Our team of experts at BPM Lighting have the experience and resources you need to offer superb lighting products that adapt to every need.

Whatever the project, whether for a small room at home or a large retail establishment, we ensure a perfect combination of design and efficiency, both inseparable qualities for shaping your decorative scheme.

At BPM Lighting, personal service and customisation are among our main strengths: lighter finishes, more colourways, innovative fixtures, and versatile installation systems. Our mission is to satisfy your requirements for a dazzling finish.



La idea y el resultado. Y en el proceso, la tecnología más puntera a su servicio. En BPM Lighting contamos con un equipo profesional altamente especializado, con la experiencia y los recursos que nos permiten ofrecer soluciones lumínicas del más alto nivel y adaptadas a cada necesidad.

En cualquier proyecto, sea para una pequeña estancia del hogar o una gran superficie comercial, diseño y eficiencia han de encajar de manera perfecta, son cualidades inseparables, forman parte de una misma pieza que se amolda a cada instalación.

En BPM Lighting el trabajo personalizado y la customización son pilares fundamentales: acabados más ligeros, mayor gama de colores, apliques innovadores, sistema de instalación versátiles. El objetivo: encajar las posibilidades para conseguir un acabado deslumbrante.

RE-DESIGN



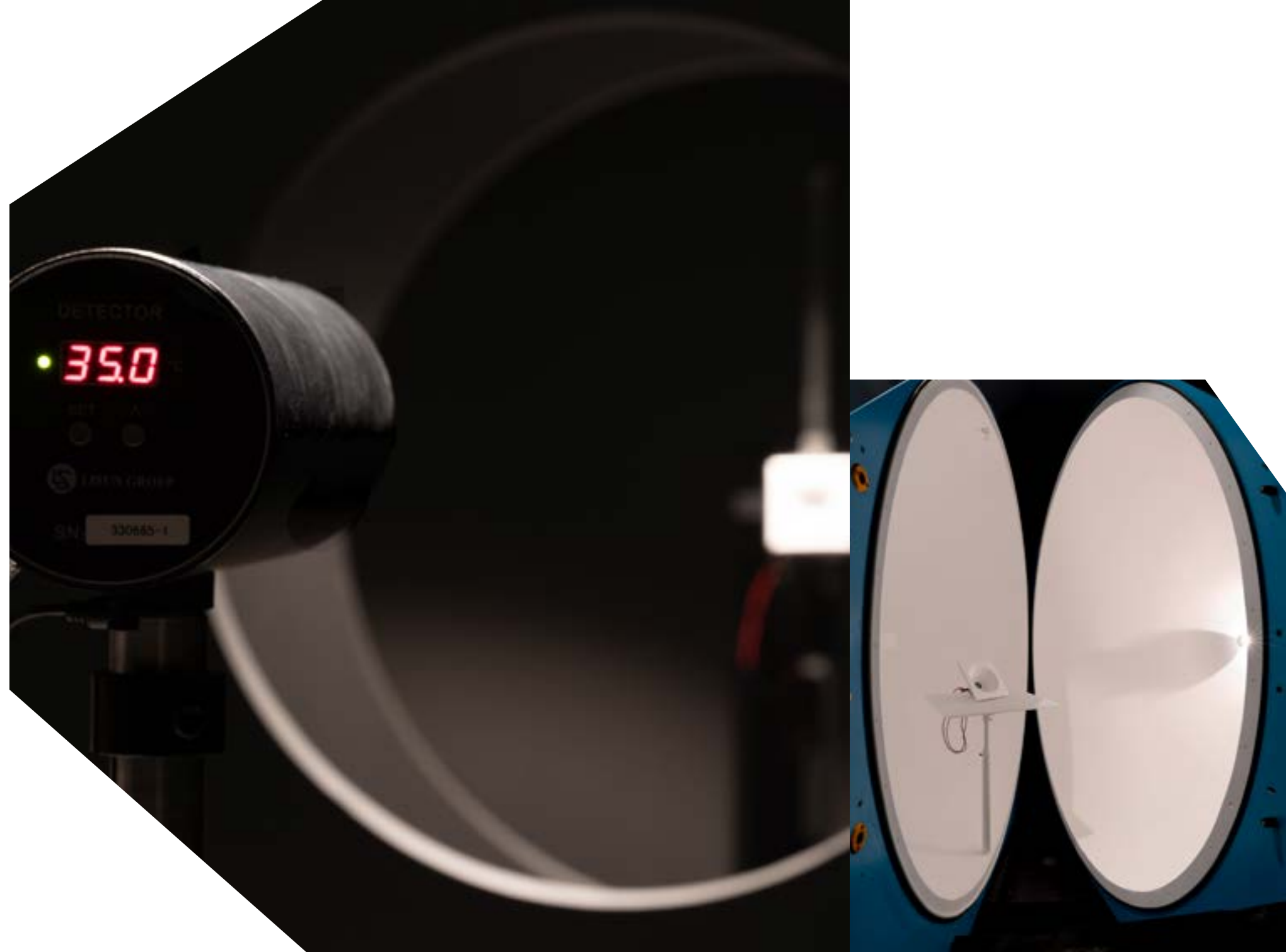

The best of BPM Lighting is yet to come. However, resting on our laurels is not part of our corporate philosophy. We never stop building new families, making improvements and evolving our existing success stories. It is never enough.

That's why we have an R&D+i department with its own laboratory. That's where we design, analyse, test and optimise our designs to create trend-setting advanced lighting solutions.

State-of-the-art technology combined with our expert know gives us a competitive advantage, added value that keeps us at the forefront of the industry to offer stand-out services and products.

Lo mejor de BPM Lighting está aún por llegar. Acomodarse no entra en nuestra filosofía de empresa. Mientras desarrollamos nuevas familias se contemplan sus mejoras y evoluciones. Nunca es suficiente.

Por ello contamos con un departamento de I+D+i dotado de laboratorio propio. En él diseñamos, estudiamos, testamos y optimizamos nuestros productos para obtener como resultado soluciones lumínicas avanzadas que marquen tendencia en nuestro sector.

La tecnología punta, combinada con el know how de nuestros desarrolladores garantizan esa ventaja competitiva, ese valor añadido que nos permite ir por delante en oferta de servicios y productos.

RE-THINK



Bespoke. We co-create to achieve excellence. BPM Bespoke Madrid participates in the global BPM Lighting project as a meeting point for professional lighting experts, creating unique lighting solutions customised and designed for each project. BPM Bespoke London was the first of these spaces to revolutionise ways of working together on projects. The new premises in Las Rozas, Madrid draws on our experiences and is adapted to the needs of the domestic market. Interior designers, architects, and builders are welcomed with open arms to a working forum with an open horizon, without limitations, where dialogue amplifies everyone's capabilities. And the result will be brilliant.

But the revolution will also be taken beyond European borders to the USA, where BPM Lighting is in the throes of making a mark with specific products and sales strategies. A new market is broadening our horizons and will herald a new era for our business project.

BESPOKE LONDON



BESPOKE MADRID

Bespoke. O lo que es lo mismo: co-crear para buscar la excelencia. BPM Bespoke Madrid se suma al proyecto global de BPM Lighting para convertirse en un punto de encuentro de profesionales que buscan soluciones lumínicas únicas, personalizadas y pensadas para cada proyecto específico. BPM Bespoke London fue el primer espacio de estas características que supuso una auténtica revolución en la manera de concebir proyectos de forma conjunta. Las nuevas instalaciones de Las Rozas en Madrid se nutre de la experiencia adquirida adaptándose a las necesidades del mercado nacional.

Interioristas, arquitectos, proyectistas, constructores tienen las puertas abiertas de un foro de trabajo en el que todo está por hacer, sin limitaciones, donde diálogo servirá para amplificar capacidades. Y el resultado será brillante.

RE-VOLUTION





Sustainability and health values. Rather than paying lip service to these qualities, we have made a real commitment. At BPM Lighting, we take on our role as manufacturers to endorse our commitment to the environment and people's well-being.

We abide by certifications, standards and guidelines such as the International Association of Lighting Designers (IALD) and Lighting Industry Resource Council (LIRC) for WELL rating systems.

Resources may be limited, but, fortunately, creativity is boundless. Re-think production methods, and offer lighting solutions in line with health and well-being. That's the way we work.

Sostenibilidad y valores de la salud. No es una ambiciosa declaración de intenciones, es la única opción viable. En BPM Lighting asumimos nuestro papel de fabricantes para refrendar el compromiso con el medio ambiente y con el bienestar de las personas.

Para ello nos servimos de pautas y estándares certificados como IALD (Asociación Internacional de Diseñadores de Iluminación) y el LIRC (Consejo de Recursos de la Industria de la Iluminación) para los sistemas de calificación WELL.

Los recursos son limitados, pero por suerte la creatividad no. Repensar las formas de producir, ofrecer soluciones lumínicas en consonancia con la salud y el bienestar. En eso trabajamos.

RE-SPECT





RE-IMAGINE

Our culture balance between tradition, innovation, tech development and industrial engineering where design is translated into a product with the utmost technical precision, lasting good looks and a high standard of technological components.

All this at the service of an idea, because our goal is to help you design the perfect Lighting solution for your project.













Let's get brighter, let's co-create, let us help you with what we do best, light!



Nuestro ADN apuesta por el diseño y la fabricación, una misma cultura que equilibra la tradición, la innovación, el desarrollo tecnológico y la ingeniería industrial. Y todo ello se traduce en un producto que tiene la máxima precisión técnica, una estética duradera y un alto estándar tecnológico.



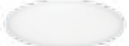

Todo ello al servicio de una idea, porque nuestro objetivo es diseñar la perfecta solución lumínica para tu proyecto.

¡Co-creemos, brillamos juntos, déjanos ayudarte con lo que mejor sabemos hacer, luz!







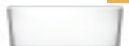

VISUAL INDEX















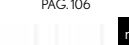

ALABAMA	PENDANT .PN	SURFACE .SR	RECESSED FRAME .RF	TRIMLESS .TR	TRACK .TK	WALL SURFACE .WS
ALABAMA SUPER SLIM 310001	 <small>new</small> PAG. 58	 <small>new</small> PAG. 58				
ALABAMA SUPER SLIM TILT 310007	 <small>new</small> PAG. 62					
ALABAMA SLIM 310002	 <small>new</small> PAG. 66	 <small>new</small> PAG. 66				
ALABAMA SLIGHT 10192	 PAG. 70	 PAG. 70				
ALABAMA SLIGHT SQ 10194	 PAG. 74	 PAG. 74				
ALABAMA 10158	 <small>new</small> PAG. 78	 <small>new</small> PAG. 78	 PAG. 396	 PAG. 580		

ALTAIR	PENDANT .PN	SURFACE .SR	RECESSED FRAME .RF	TRIMLESS .TR	TRACK .TK	WALL SURFACE .WS
ALTAIR 10172	 PAG. 82	 PAG. 82		 PAG. 584		



























OHIO	PENDANT .PN	SURFACE .SR	RECESSED FRAME .RF	TRIMLESS .TR	TRACK .TK	WALL SURFACE .WS
OHIO 10188	 <small>new</small> PAG. 86	 <small>new</small> PAG. 86	 PAG. 400	 PAG. 588		
OHIO SQ 10204			 <small>SOON</small> PAG. 404	 <small>SOON</small> PAG. 592		

VISUAL INDEX















FLORIDA	PENDANT .PN	SURFACE .SR	RECESSED FRAME .RF	TRIMLESS .TR	TRACK .TK	WALL SURFACE .WS
FLORIDA 10190	 PAG. 90	 PAG. 90	 PAG. 408	 PAG. 596		
FLORIDA SQ 10191	 PAG. 94	 PAG. 94	 PAG. 412	 PAG. 600		

ALBERTA	PENDANT .PN	SURFACE .SR	RECESSED FRAME .RF	TRIMLESS .TR	TRACK .TK	WALL SURFACE .WS
ALBERTA INSIDE 10243	 <small>new</small> PAG. 98	 <small>new</small> PAG. 98				
ALBERTA INSIDE VERTICAL 310008	 <small>new</small> PAG. 102					
ALBERTA INSIDE VTILT 310009	 <small>new</small> PAG. 106					
ALBERTA DUE 10250	 <small>new</small> PAG. 110					
ALBERTA DUE MOVE 310004	 <small>new</small> PAG. 114					
ALBERTA SOFT 10217	 PAG. 118	 PAG. 118	 PAG. 416			
ALBERTA SLIGHT 10193	 PAG. 124	 PAG. 124				
ALBERTA SLIGHT ECCENTRIC 310005	 <small>new</small> PAG. 128	 <small>new</small> PAG. 128				
ALBERTA 10176	 PAG. 132		 PAG. 420	 PAG. 604		









































VISUAL INDEX

OKKO MODULAR	PENDANT .PN	SURFACE .SR	RECESSED FRAME .RF	TRIMLESS .TR	TRACK .TK	WALL SURFACE .WS
OKKO MODULAR 10254	 SOON	 SOON				
	PAG. 138	PAG. 138				
OKKO PLUS MODULAR 10252	 SOON	 SOON				
	PAG. 142	PAG. 142				
OKKO MODULAR LINE	PENDANT .PN	SURFACE .SR	RECESSED FRAME .RF	TRIMLESS .TR	TRACK .TK	WALL SURFACE .WS
OKKO MODULAR LINE 210012 410012	 SOON	 SOON	 SOON			
	PAG. 150	PAG. 150	PAG. 468			
OKKO PLUS MODULAR LINE 210013 410013	 SOON	 SOON	 SOON			
	PAG. 154	PAG. 154	PAG. 470			
EYE	PENDANT .PN	SURFACE .SR	RECESSED FRAME .RF	TRIMLESS .TR	TRACK .TK	WALL SURFACE .WS
EYE 210016						
	PAG. 158	PAG. 158		PAG. 610		
ALARIK	PENDANT .PN	SURFACE .SR	RECESSED FRAME .RF	TRIMLESS .TR	TRACK .TK	WALL SURFACE .WS
ALARIK MINI 210006	 new	 new		 new		
	PAG. 164	PAG. 164		PAG. 616		
ALARIK MINI ROUND 210004	 new	 new				
	PAG. 170	PAG. 170				
ALARIK SLIM 20224	 new	 new	 new	 new		
	PAG. 178	PAG. 178	PAG. 428	PAG. 622		
ALARIK SLIM ROUND 210019	 new	 new				
	PAG. 184	PAG. 184				
ALARIK 10225						
	PAG. 190	PAG. 190		PAG. 628		

















VISUAL INDEX

MODULIGHT	PENDANT .PN	SURFACE .SR	RECESSED FRAME .RF	TRIMLESS .TR	TRACK .TK	WALL SURFACE .WS
MODULIGHT 10210						
	PAG. 196	PAG. 196	PAG. 434	PAG. 634		
OKKIA	PENDANT .PN	SURFACE .SR	RECESSED FRAME .RF	TRIMLESS .TR	TRACK .TK	WALL SURFACE .WS
OKKIA 210007	 new	 new				
	PAG. 202	PAG. 202				
OKKIA PLUS 210017	 new					
	PAG. 206					
LINGGO	PENDANT .PN	SURFACE .SR	RECESSED FRAME .RF	TRIMLESS .TR	TRACK .TK	WALL SURFACE .WS
LINGGO MINI 210003	 new	 new				
	PAG. 210	PAG. 210				
LINGGO 210002	 new	 new				
	PAG. 214	PAG. 214				
BUBBLE	PENDANT .PN	SURFACE .SR	RECESSED FRAME .RF	TRIMLESS .TR	TRACK .TK	WALL SURFACE .WS
BUBBLE 210010	 new	 new				
	PAG. 218	PAG. 218				
EDGE	PENDANT .PN	SURFACE .SR	RECESSED FRAME .RF	TRIMLESS .TR	TRACK .TK	WALL SURFACE .WS
EDGE 210014		 new				
		PAG. 222				

















VISUAL INDEX

ALBA	PENDANT .PN	SURFACE .SR	RECESSED FRAME .RF	TRIMLESS .TR	TRACK .TK	WALL SURFACE .WS
ALBA MINI 10211	 PAG. 226	 PAG. 226	 PAG. 440	 PAG. 640		
ALBA 10160	 PAG. 230	 PAG. 230	 PAG. 444	 PAG. 644	 PAG. 760	 PAG. 786
ALBA NOVUS 210011	 PAG. 234					
ALBA DOUBLE 10215	 PAG. 238					 PAG. 790
ALBA ASIMETRIC 210009	 PAG. 242	 PAG. 242	 PAG. 448	 PAG. 648		 PAG. 794
ALBA PLUS 10178	 PAG. 246	 PAG. 246	 PAG. 452	 PAG. 652	 PAG. 764	
ALBA PLUS ASIMETRIC 210008	 PAG. 250	 PAG. 250	 PAG. 456	 PAG. 656		
BOLD	PENDANT .PN	SURFACE .SR	RECESSED FRAME .RF	TRIMLESS .TR	TRACK .TK	WALL SURFACE .WS
BOLD 210001	 PAG. 254	 PAG. 254	 PAG. 460			
BOLD LINE 210015	 PAG. 254	 PAG. 254	 PAG. 460			
TRIBOLD 210018	 PAG. 258	 PAG. 258				
WING	PENDANT .PN	SURFACE .SR	RECESSED FRAME .RF	TRIMLESS .TR	TRACK .TK	WALL SURFACE .WS
WING 10200	 PAG. 262	 PAG. 262	 PAG. 464	 PAG. 660		
ALZIRA	PENDANT .PN	SURFACE .SR	RECESSED FRAME .RF	TRIMLESS .TR	TRACK .TK	WALL SURFACE .WS
ALZIRA 10169	 PAG. 266					 PAG. 798























VISUAL INDEX

ACOUSTIC	PENDANT .PN	SURFACE .SR	RECESSED FRAME .RF	TRIMLESS .TR	TRACK .TK	WALL SURFACE .WS
ACOUSTIC ALZIRA 230002	 PAG. 272					 PAG. 802
ACOUSTIC ALBA 230004	 PAG. 276	 PAG. 276				
ACOUSTIC LINGGO MINI 230007	 PAG. 280					
ACOUSTIC LAMBDA 230001	 PAG. 284	 PAG. 284				
ACOUSTIC ALBA MINI 230008	 PAG. 288					
ACOUSTIC ALARIK SLIM 230009	 PAG. 292					
ACOUSTIC OKKO 230003	 PAG. 298					
ACOUSTIC ALBERTA SOFT 230010	 PAG. 302					
ACOUSTIC ALABAMA 460001 460003	 PAG. 306					
ACOUSTIC KLIMT FIX 460002 460004	 PAG. 310					
ACOUSTIC ACCESORIES AC RD SQ VT FL MD	 PAG. 314	 PAG. 314				 PAG. 806























VISUAL INDEX

MARTORELL	PENDANT .PN	SURFACE .SR	RECESSED FRAME .RF	TRIMLESS .TR	TRACK .TK	WALL SURFACE .WS
MARTORELL 20115	 PAG. 322 new	 PAG. 322 new	 PAG. 494	 PAG. 676	 PAG. 744	
MARTORELL MOVE 20110		 PAG. 324 new	 PAG. 496 new			
MARTORELL TUBE MOVE 20138		 PAG. 326		 PAG. 746		
MARTORELL MINI CRATE 20175		 PAG. 328	 PAG. 502			
MARTORELL CRATE 20176		 PAG. 330	 PAG. 504			
MARTORELL SQ 20132		 PAG. 332				
MARTORELL SQ2 20133		 PAG. 332				
MARTORELL TARREGA 20117			 PAG. 498	 PAG. 678		
MARTORELL TARREGA SQ 20116			 PAG. 500	 PAG. 678		
MARTORELL TARREGA SQ2 20119			 PAG. 500			
MARTORELL TUBULAR 20 40 60 20125 20192 20196	 PAG. 334	 PAG. 334				
MARTORELL TUBULAR TILT 20195		 PAG. 336				











VISUAL INDEX

PATRICIA TK	PENDANT .PN	SURFACE .SR	RECESSED FRAME .RF	TRIMLESS .TR	TRACK .TK	WALL SURFACE .WS
PATRICIA TK 30514					 PAG. 736 new	
GEO	PENDANT .PN	SURFACE .SR	RECESSED FRAME .RF	TRIMLESS .TR	TRACK .TK	WALL SURFACE .WS
GEO 30511		 PAG. 342 new	 PAG. 512 new		 PAG. 750 new	
KLIMT	PENDANT .PN	SURFACE .SR	RECESSED FRAME .RF	TRIMLESS .TR	TRACK .TK	WALL SURFACE .WS
KLIMT 20134		 PAG. 338	 PAG. 508		 PAG. 748	
KLIMT FIX 20135		 PAG. 340 new	 PAG. 510 new			
LUK	PENDANT .PN	SURFACE .SR	RECESSED FRAME .RF	TRIMLESS .TR	TRACK .TK	WALL SURFACE .WS
LUK FREIR 20018		 PAG. 344	 PAG. 514	 PAG. 680		
LUK FREIR 2 20019		 PAG. 344	 PAG. 514	 PAG. 680		
LUK 20028			 PAG. 516			
LUK 2 20071			 PAG. 516			
LUK CRUSADER 20082		 PAG. 346				 PAG. 752
LUK HAWKEYE 20083		 PAG. 348				 PAG. 754
LUK HAWKEYE 2 20084		 PAG. 348				 PAG. 754













VISUAL INDEX

CUBE	PENDANT .PN	SURFACE .SR	RECESSED FRAME .RF	TRIMLESS .TR	TRACK .TK	WALL SURFACE .WS
CUBE SQ 8201		 PAG. 354	 PAG. 518	 PAG. 682		
CUBE SQ2 8202		 PAG. 354	 PAG. 518	 PAG. 682		
CUBE SQ3 8203		 PAG. 354	 PAG. 518	 PAG. 682		
CUBE TUBE 9050 9052	 PAG. 350	 PAG. 350			 PAG. 756	
CUBE TUBE MOVE 9051 9053	 PAG. 352	 PAG. 352				
CUBE SPOT 3120			 PAG. 522			
CUBE SPOT 2 3131			 PAG. 522			
CUBE SPOT MOVE 3121			 PAG. 524			
CUBE SPOT 2 MOVE 3136			 PAG. 524			
CUBE SPOT SQ MOVE 3134			 PAG. 526			
CUBE SPOT SQ 2 MOVE 3135			 PAG. 526			
ORACLE	PENDANT .PN	SURFACE .SR	RECESSED FRAME .RF	TRIMLESS .TR	TRACK .TK	WALL SURFACE .WS
ORACLE 20087	 PAG. 360	 PAG. 360			 PAG. 758	









VISUAL INDEX

FACE	PENDANT .PN	SURFACE .SR	RECESSED FRAME .RF	TRIMLESS .TR	TRACK .TK	WALL SURFACE .WS
FACE TUBULAR 20205	 PAG. 364	 PAG. 362	 PAG. 506			
FACE TUBULAR SPAC 20207	 PAG. 366					
FACE KIERA 20204	 PAG. 368					
FACE KIERA CEMENT 20208	 PAG. 370					
FACE IRIS 20203	 PAG. 372					
SUBLIM	PENDANT .PN	SURFACE .SR	RECESSED FRAME .RF	TRIMLESS .TR	TRACK .TK	WALL SURFACE .WS
SUBLIM 20206	 PAG. 374					
GALANTA	PENDANT .PN	SURFACE .SR	RECESSED FRAME .RF	TRIMLESS .TR	TRACK .TK	WALL SURFACE .WS
GALANTA DEEP 410001			 PAG. 492			
GALANTA BONETE 20222	 PAG. 376					
VENICE	PENDANT .PN	SURFACE .SR	RECESSED FRAME .RF	TRIMLESS .TR	TRACK .TK	WALL SURFACE .WS
VENISE 410011	 PAG. 378					













VISUAL INDEX

LENT	PENDANT .PN	SURFACE .SR	RECESSED FRAME .RF	TRIMLESS .TR	TRACK .TK	WALL SURFACE .WS
LENT MODULAR 10216			 PAG. 472	 PAG. 666		
LENT MOTION 10212			 PAG. 474			
SASSY	PENDANT .PN	SURFACE .SR	RECESSED FRAME .RF	TRIMLESS .TR	TRACK .TK	WALL SURFACE .WS
SASSY 410002			 PAG. 476	 PAG. 668		
SASSY SQ 410003			 PAG. 482	 PAG. 672		
VADI	PENDANT .PN	SURFACE .SR	RECESSED FRAME .RF	TRIMLESS .TR	TRACK .TK	WALL SURFACE .WS
VADI 3177			 PAG. 534			
ROY	PENDANT .PN	SURFACE .SR	RECESSED FRAME .RF	TRIMLESS .TR	TRACK .TK	WALL SURFACE .WS
ROY 20154			 PAG. 538			
CAN REVIEW	PENDANT .PN	SURFACE .SR	RECESSED FRAME .RF	TRIMLESS .TR	TRACK .TK	WALL SURFACE .WS
CAN REVIEW 20149			 PAG. 528			
ALDAIA	PENDANT .PN	SURFACE .SR	RECESSED FRAME .RF	TRIMLESS .TR	TRACK .TK	WALL SURFACE .WS
ALDAIA 20157			 PAG. 530			
ALDAIA SQ 20120			 PAG. 532			



VISUAL INDEX







VIO	PENDANT .PN	SURFACE .SR	RECESSED FRAME .RF	TRIMLESS .TR	TRACK .TK	WALL SURFACE .WS
VIO 20185			 PAG. 488			
VIO DEEP 20186			 PAG. 488			
VIO DOME 20183			 PAG. 488			
VIO SQ 20181			 PAG. 488			
VIO MOVE 20184			 PAG. 488			
VIO DEEP MOVE 20187			 PAG. 488			
VIO DOME MOVE 20182			 PAG. 488			
VIO SQ MOVE 20180			 PAG. 488			

VISUAL INDEX





CATLI	PENDANT .PN	SURFACE .SR	RECESSED FRAME .RF	TRIMLESS .TR	TRACK .TK	WALL SURFACE .WS
CATLI 3010		 PAG.358	 PAG. 560			
CATLI SQ 3011		 PAG. 358	 PAG. 562			
CATLI SQ2 3012			 PAG. 564			
CATLI SQ3 3013			 PAG. 566			
CATLI HALKA 3017			 PAG. 568			
CATLI HALKA SQ 3021			 PAG. 568			
CATLI ODALKI 3018			 PAG. 570			
CATLI CLASSIC 3005			 PAG. 572			
CATLI CLASSIC SQ 3006			 PAG. 574			
CATLI CARE 3000			 PAG. 576			
CATLI CARE 2 3001			 PAG. 576			

VISUAL INDEX

SU	PENDANT .PN	SURFACE .SR	RECESSED FRAME .RF	TRIMLESS .TR	TRACK .TK	WALL SURFACE .WS
SU 3149			 PAG. 540			
SU SQ 3150			 PAG. 540			
SU OTIS 3234			 PAG. 542			











BASIT	PENDANT .PN	SURFACE .SR	RECESSED FRAME .RF	TRIMLESS .TR	TRACK .TK	WALL SURFACE .WS
BASIT 8012			 PAG. 544			
BASIT MOVE 8013			 PAG.544			
BASIT MONET 20130			 PAG. 546			
BASIT MONET 2 20131			 PAG. 546			
BASIT LLORENS 20140			 PAG. 548			
BASIT LLORENS SQ 20144			 PAG. 548			
BASIT DERIN 8010			 PAG. 550			

VISUAL INDEX





KONI	PENDANT .PN	SURFACE .SR	RECESSED FRAME .RF	TRIMLESS .TR	TRACK .TK	WALL SURFACE .WS
KONI 3161			 PAG. 552			
KONI SQ 3169			 PAG. 554 new			
KONI DEEP 3171			 PAG. 556 new			
KONI TURTA 3156			 PAG. 558			

CASTEJON	PENDANT .PN	SURFACE .SR	RECESSED FRAME .RF	TRIMLESS .TR	TRACK .TK	WALL SURFACE .WS
CASTEJON 20074			 PAG. 536			
CASTEJON SQ 20073			 PAG. 536			

VISUAL INDEX

LUMINAIRES	PENDANT .PN	SURFACE .SR	RECESSED FRAME .RF	TRIMLESS .TR	WALL RECESSED .WR	WALL SURFACE .WS
HURY 10251						 PAG. 772 new
KUU 410014						 PAG. 776 new
KAPI 9000						 PAG. 778
IKI 9011						 PAG. 780
OKUMA 8105						 PAG. 782
ELENA 8106						 PAG. 784
MAGRIT 20127						 PAG. 824
KLEE 20128						 PAG. 824
KLEE SQ 20129						 PAG. 824
ADIMA 8104						 PAG. 826
ADIMA SQ 8103						 PAG. 826



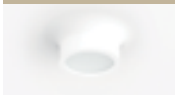
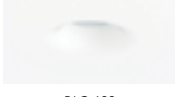

VISUAL INDEX

NOCTUA	PENDANT .PN	SURFACE .SR	RECESSED FRAME .RF	TRIMLESS .TR	WALL RECESSED .WR	WALL SURFACE .WS
NOCTUA 10103		CRISMOSIL  PAG. 384				
NOCTUA SQ 10099		CRISMOSIL  PAG. 386				
NOCTUA DEEP 10100		CRISMOSIL  PAG. 388				
NOCTUA VENUS 10102		CRISMOSIL  PAG. 390				





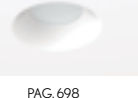

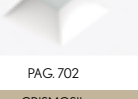
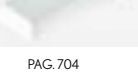

VITA	PENDANT .PN	SURFACE .SR	RECESSED FRAME .RF	TRIMLESS .TR	WALL RECESSED .WR	WALL SURFACE .WS
VITA 30007				CRISMOSIL SOON  PAG. 688		

VOLCANO	PENDANT .PN	SURFACE .SR	RECESSED FRAME .RF	TRIMLESS .TR	WALL RECESSED .WR	WALL SURFACE .WS
VOLCANO 10062				CRISMOSIL  PAG. 690		
VOLCANO DEEP 10063				CRISMOSIL  PAG. 692		

VISUAL INDEX



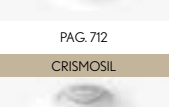





ESPIGA	PENDANT .PN	SURFACE .SR	RECESSED FRAME .RF	TRIMLESS .TR	TRACK .TK	WALL SURFACE .WS
ESPIGA 10086				CRISMOSIL  PAG. 694		
ESPIGA SQ 10083				CRISMOSIL  PAG. 696		
ESPIGA SIRIO 10077				CRISMOSIL  PAG. 698		
ESPIGA SIRIO TWINS 30000				CRISMOSIL  PAG. 700		
ESPIGA ORIONIS 10080				CRISMOSIL  PAG. 702		
ESPIGA ORIONIS TWINS 30001				CRISMOSIL  PAG. 704		

VISUAL INDEX







ZENIT	PENDANT .PN	SURFACE .SR	RECESSED FRAME .RF	TRIMLESS .TR	WALL RECESSED .WR	WALL SURFACE .WS
ZENIT 10123				CRISMOSIL 		
				PAG. 707		
ZENIT SQ 30002				CRISMOSIL 		
				PAG. 706		
ZENIT DEEP 30004				CRISMOSIL 		
				PAG. 708		
ZENIT DEEP TWINS 30005				CRISMOSIL 		
				PAG. 709		
ZENIT MOVE 10125				CRISMOSIL 		
				PAG. 710		
ZENIT MOVE SQ 30003				CRISMOSIL 		
				PAG. 711		
ZENIT ORTO 10126				CRISMOSIL 		
				PAG. 712		
ZENIT SIDEREA 10050				CRISMOSIL 		
				PAG. 713		
ZENIT ZUBIA 10122				CRISMOSIL 		
				PAG. 714		
ZENIT ZUBIA SQ 10121				CRISMOSIL 		
				PAG. 715		



SUNSET	PENDANT .PN	SURFACE .SR	RECESSED FRAME .RF	TRIMLESS .TR	WALL RECESSED .WR	WALL SURFACE .WS
SUNSET 10124				CRISMOSIL 		
				PAG. 716		





VISUAL INDEX





VEGA	PENDANT .PN	SURFACE .SR	RECESSED FRAME .RF	TRIMLESS .TR	WALL RECESSED .WR	WALL SURFACE .WS
VEGA ADHARA 10016				CRISMOSIL 		
				PAG. 718		
VEGA ADHARA TWINS 10066				CRISMOSIL 		
				PAG. 720		
VEGA 10028				CRISMOSIL 		
				PAG. 722		
VEGA TWINS 10070				CRISMOSIL 		
				PAG. 724		
VEGA ZETA 10001				CRISMOSIL 		
				PAG. 726		
VEGA ZETA SQ 10019				CRISMOSIL 		
				PAG. 728		
ZETA SQ TWINS 10072				CRISMOSIL 		
				PAG. 730		
CENTAURO	PENDANT .PN	SURFACE .SR	RECESSED FRAME .RF	TRIMLESS .TR	WALL RECESSED .WR	WALL SURFACE .WS
CENTAURO 10109				CRISMOSIL 		
				PAG. 732		

VISUAL INDEX





WALL	PENDANT .PN	SURFACE .SR	RECESSED FRAME .RF	TRIMLESS .TR	WALL RECESSED .WR	WALL SURFACE .WS
WALL METIS 10098						CRISMOSIL  PAG. 810
WALLELARA 10097						CRISMOSIL  PAG. 812
WALL TEBE 10096						CRISMOSIL  PAG. 814
WALL LEDA 10051						CRISMOSIL  PAG. 816
WALL ARCE 10055						CRISMOSIL  PAG. 818
WALL CARPO 10059						CRISMOSIL  PAG. 820

FLOOR WASHER	PENDANT .PN	SURFACE .SR	RECESSED FRAME .RF	TRIMLESS .TR	WALL RECESSED .WR	WALL SURFACE .WS
LYRA 10560						CRISMOSIL  PAG. 830
TYRA 10561						CRISMOSIL  PAG. 828
MYRA 10564						CRISMOSIL  PAG. 832

ORBIT	PENDANT .PN	SURFACE .SR	RECESSED FRAME .RF	TRIMLESS .TR	WALL RECESSED .WR	WALL SURFACE .WS
ORBIT 10091						CRISMOSIL  PAG. 834
ORBIT SQ 10090						CRISMOSIL  PAG. 835
ORBIT NADIR 10113						CRISMOSIL  PAG. 836
ORBIT NADIR SQ 10114						CRISMOSIL  PAG. 838
ORBIT ARA 10006						CRISMOSIL  PAG. 840

DRACO	PENDANT .PN	SURFACE .SR	RECESSED FRAME .RF	TRIMLESS .TR	WALL RECESSED .WR	WALL SURFACE .WS
DRACO 10119						CRISMOSIL  PAG. 842
DRACO TUCANA 10008						CRISMOSIL  PAG. 845
DRACO ZAHARA 10009						CRISMOSIL  PAG. 846
DRACO ORION 10011						CRISMOSIL  PAG. 848

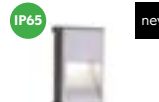
VISUAL INDEX

OUTDOOR	PENDANT .PN	SURFACE .SR	RECESSED FRAME .RF	TRIMLESS .TR	WALL RECESSED .WR	WALL SURFACE .WS
WALL ZEN OUT 11600						 IP65 new
WALL ZEN SQ OUT 11601						 IP65 new
WALL ARA OUT 10006					 IP65 new	
WALL ZAHARA OUT 10009					 IP65 new	
WALL DRACO OUT 10119					 IP65 new	
NOCTUA SQ OUT 10099		 IP65 new				



PAG. 852



PAG. 854



PAG. 856

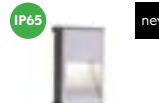

PAG. 857



PAG. 858



































PAG. 860

INDEX

USEFUL PAGES

PENDANT

ALABAMA	 new ALABAMA SUPER SLIM 310001 PAG. 58	 new ALABAMA SUPER SLIM TILT 310007 PAG. 62	 new ALABAMA SLIM 310002 PAG. 66	 ALABAMA SLIGHT 10192 PAG. 70	 ALABAMA SLIGHT SQ 10194 PAG. 74	 ALABAMA 10158 PAG. 78
ALTAIR	 ALTAIR 10172 PAG. 82	OHIO				 new OHIO 10188 PAG. 86
FLORIDA	 FLORIDA 10190 PAG. 90	 FLORIDA SQ 10191 PAG. 94				
ALBERTA	 new ALBERTA INSIDE 10243 PAG. 98	 new ALBERTA INSIDE VERTICAL 310008 PAG. 102	 new ALBERTA INSIDE V-TILT 310009 PAG. 106	 new ALBERTA DUE 10250 PAG. 110	 new ALBERTA DUE MOVE 310004 PAG. 114	 ALBERTA SOFT 10217 PAG. 118
	 ALBERTA SLIGHT 10193 PAG. 124	 new ALBERTA SLIGHT ECCENTRIC 310005 PAG. 128	 ALBERTA 10176 PAG. 132			
OKKO MODULAR	 SOON OKKO MODULAR 10254 PAG. 138	 SOON OKKO PLUS MODULAR 10252 PAG. 142				
OKKO MODULAR LINE	 SOON OKKO MODULAR LINE 210012 PAG. 150	 SOON OKKO PLUS MODULAR LINE 210013 PAG. 154	EYE			 EYE 210016 PAG. 158
ALARIK	 new ALARIK MINI 210006 PAG. 164	 new ALARIK MINI ROUND 210004 PAG. 170	 new ALARIK SLIM 20224 PAG. 178	 new ALARIK SLIM ROUND 210019 PAG. 184	 ALARIK 10225 PAG. 190	
MODULIGHT	 MODULIGHT 10210 PAG. 196	OKKIA			 new OKKIA 210007 PAG. 202	 new OKKIA PLUS 210017 PAG. 206

VISUAL INDEX

LINGGO	 new LINGGO MINI 210003 PAG. 210	 new LINGGO 210002 PAG. 214	BUBBLE			 new BUBBLE 210010 PAG. 216
ALBA	 ALBA MINI 10211 PAG. 226	 new ALBA 10160 PAG. 230	 ALBA NOVUS 210011 PAG. 234	 new ALBA DOUBLE 10215 PAG. 238	 ALBA ASIMETRIC 210009 PAG. 242	 ALBA PLUS 10178 PAG. 246
	 new ALBA PLUS ASIMETRIC 210008 PAG. 250					
BOLD	 SOON BOLD 210001 PAG. 254	 SOON BOLD LINE 210015 PAG. 256	 SOON TRIBOLD 210018 PAG. 258	WING		 WING 10200 PAG. 262
ALZIRA	 ALZIRA 10169 PAG. 266					
ACOUSTIC	 new AC. ALZIRA 230002 PAG. 272	 new AC. ALBA 230004 PAG. 276	 new AC. LINGGO MINI 230007 PAG. 280	 new AC. LAMBDA 230001 PAG. 284	 new AC. ALBA MINI 230008 PAG. 288	 new AC. ALARIK 230009 PAG. 292
	 new AC. OKKO 230003 PAG. 298	 new AC. ALBERTA SOFT 230010 PAG. 302	 new AC. ALABAMA 460001 3 PAG. 306	 new AC. KLIMT 460002 4 PAG. 310	 new AC. ACCESSORIES RD SQ VT FL PAG. 314	
MARTORELL	 MARTORELL 20115 PAG. 322	 MARTORELL TUBULAR 20 20125 PAG. 334	 MARTORELL TUBULAR 40 20192 PAG. 334	 MARTORELL TUBULAR 60 20196 PAG. 334		
CUBE	 CUBE TUBE 9050-9052 PAG. 350	 CUBE TUBE MOVE 9051-9053 PAG. 352		ORACLE		
	 ORACLE 20087 PAG. 360					

PENDANT

FACE





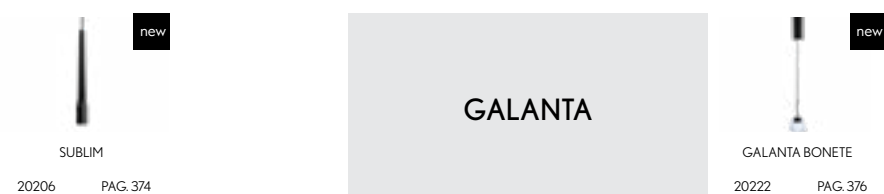



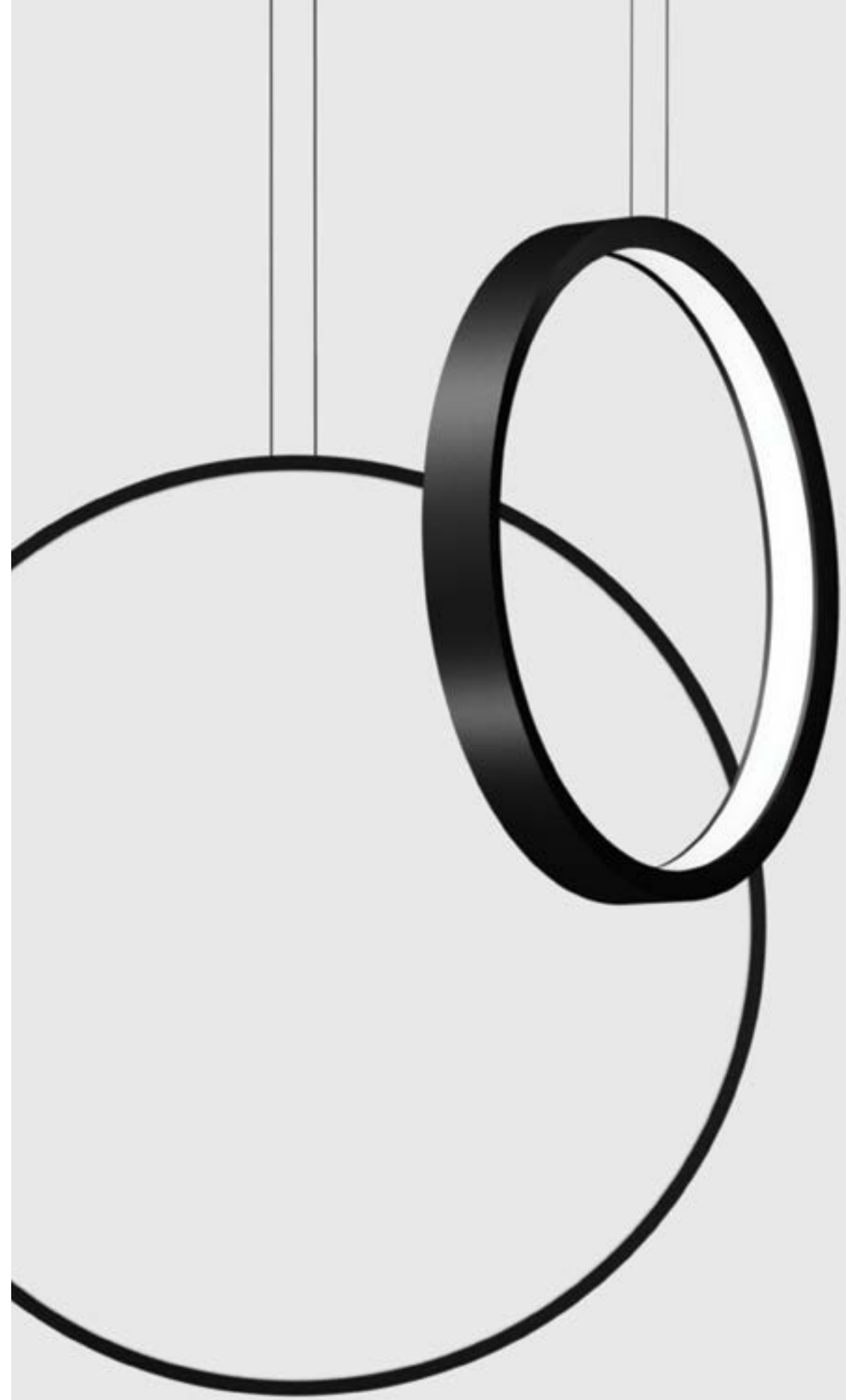





















SUBLIM

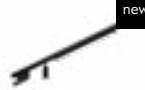

VENISE



SURFACE

ALABAMA	 <small>new</small> ALABAMA SUPER SLIM 310001 PAG. 58	 <small>new</small> ALABAMA SLIM 310002 PAG. 66	 ALABAMA SLIGHT 10192 PAG. 70	 ALABAMA SLIGHT SQ 10194 PAG. 74	 ALABAMA 10158 PAG. 78
ALTAIR	 ALTAIR 10172 PAG. 82	OHIO			 <small>new</small> OHIO 10188 PAG. 86
FLORIDA	 FLORIDA 10190 PAG. 90	 FLORIDA SQ 10191 PAG. 94			
ALBERTA	 <small>new</small> ALBERTA INSIDE 10243 PAG. 98	 ALBERTA SOFT 10217 PAG. 118	 ALBERTA SLIGHT 10193 PAG. 124	 <small>new</small> ALBERTA SLIGHT ECCENTRIC 310005 PAG. 128	
OKKO MODULAR	 <small>SOON</small> OKKO MODULAR 10254 PAG. 138	 <small>SOON</small> OKKO PLUS MODULAR 10252 PAG. 142	OKKO PLUS MODULAR		 <small>SOON</small> OKKO MODULAR LINE 210012 PAG. 150
				 <small>SOON</small> OKKO PLUS MODULAR LINE 210013 PAG. 154	
EYE	 EYE 210016 PAG. 158				
ALARIK	 <small>new</small> ALARIK MINI 210006 PAG. 164	 <small>new</small> ALARIK MINI ROUND 210004 PAG. 170	 <small>new</small> ALARIK SLIM 20224 PAG. 178	 <small>new</small> ALARIK SLIM ROUND 210019 PAG. 184	 ALARIK 10225 PAG. 190
MODULIGHT	 MODULIGHT 10210 PAG. 196	OKKIA			 <small>new</small> OKKIA 210007 PAG. 202
LINGGO	 <small>new</small> LINGGO MINI 210003 PAG. 210	 <small>new</small> LINGGO 210002 PAG. 214	BUBBLE	 <small>new</small> BUBBLE 210010 PAG. 218	EDGE
				 <small>new</small> EDGE 210014 PAG. 222	

VISUAL INDEX

ALBA	 ALBA MINI 10211 PAG. 226	 ALBA 10160 PAG. 230	 <small>new</small> ALBA ASIMETRIC 210009 PAG. 242	 ALBA PLUS 10178 PAG. 246	 <small>new</small> ALBA PLUS ASIMETRIC 210008 PAG. 250
BOLD	 <small>SOON</small> BOLD 210001 PAG. 254	 <small>SOON</small> BOLD LINE 210015 PAG. 256	 <small>SOON</small> TRIBOLD 210018 PAG. 258	WING	
				 WING 10200 PAG. 262	
ACOUSTIC	 <small>new</small> AC ALBA 230004 PAG. 276	 <small>new</small> AC LAMBDA 230001 PAG. 284	 <small>new</small> ACOUSTIC ACCESSORIES RD[SQ]VTJFL PAG. 314		
MARTORELL	 MARTORELL 20115 PAG. 322	 MARTORELL MOVE 20110 PAG. 324	 MARTORELL TUBE MOVE 20138 PAG. 326	 MARTORELL SQ 20132 PAG. 328	 MARTORELL SQ2 20133 PAG. 328
	 MARTORELL TUBULAR 40 20192 PAG. 334	 MARTORELL TUBULAR 60 20196 PAG. 334	 MARTORELL TUBULAR TILT 20195 PAG. 332	 MARTORELL MINI CRATE 20175 PAG. 334	 MARTORELL CRATE 20176 PAG. 336
KLIMT	 KLIMT 20134 PAG. 338	 <small>new</small> KLIMT FIX 20135 PAG. 340	GEO		 <small>new</small> GEO 30511 PAG. 342
LUK	 LUK FREIR 20018 PAG. 344	 LUK FREIR 2 20019 PAG. 344	 LUK CRUSADER 20082 PAG. 346	 LUK HAWKEYE 20083 PAG. 348	 LUK HAWKEYE 2 20084 PAG. 348
CUBE	 CUBE TUBE 9050-9052 PAG. 350	 CUBE TUBE MOVE 9051-9053 PAG. 352	 CUBE 8201 PAG. 354	 CUBE SQ2 8202 PAG. 354	 CUBE SQ3 3012 PAG. 354
ORACLE	 ORACLE 20087 PAG. 360	FACE			 FACE TUBULAR 20205 PAG. 362

SURFACE

CATLI



NOCTUA



A bright idea for any room

The ultimate aim: to focus, not distract. Hence the simplicity of our Alabama, Altair, Alberta, Ohio and Florida luminaires. Square or round, whose minimalism conceals an enormous potential to create unique environments.

All these luminaires feature extruded aluminium profiles and opal or microprismatic diffusers to provide even light. The result is enveloping, optimal background lighting with scope to play with the intensity of light.

Ambientes con luz propia

La finalidad última: convertir el espacio iluminado en protagonista. De ahí la simplicidad de los modelos que conforman las familias Alabama, Altair, Alberta, Ohio y Florida. Cuadrados o redondos, con relativa sencillez en sus acabados pero con un enorme potencial de crear atmósferas únicas.

Los modelos Alabama se presentan en perfiles de aluminio extruido y difusores opales o microprismáticos para garantizar una iluminación uniforme y homogénea. Se consigue por ello un ambiente general de iluminación óptima, envolvente, que nos permite jugar con la intensidad de la luz.



LARGE LUMINAIRES

LUMINARIAS DE GRAN FORMATO

PENDANT | SURFACE

PROFILE

OVERVIEW

PENDANT | SURFACE



ALBERTA
REF. 10176
PAG. 132



ALBERTA SLIGHT
REF. 10193
PAG. 124



ALBERTA SLIGHT ECCENTRIC
REF. 310005
PAG. 128



ALBERTA SOFT
REF. 10217
PAG. 118



ALBERTA INSIDE | VERTICAL | VTILT
REF. 10243 | 310008 | 310009
PAG. 98 | 102 | 106



ALBERTA DUE | MOVE
REF. 10250 | 310004
PAG. 110 | 114



OKKO MODULAR
REF. 10254
PAG. 138



OKKO PLUS MODULAR
REF. 10252
PAG. 142

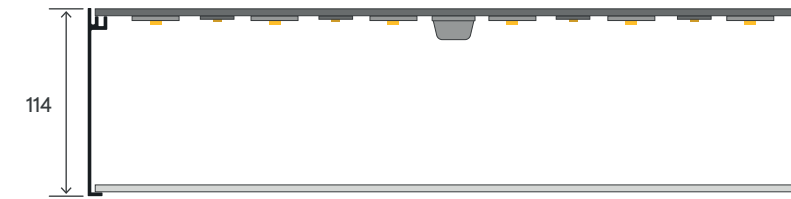

ALABAMA
REF. 10158
PAG. 78

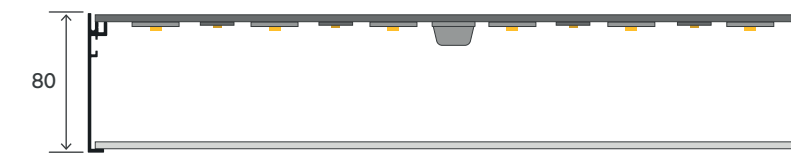

ALABAMA SLIGHT | SQ
REF. 10192 | 10194
PAG. 70 | 74

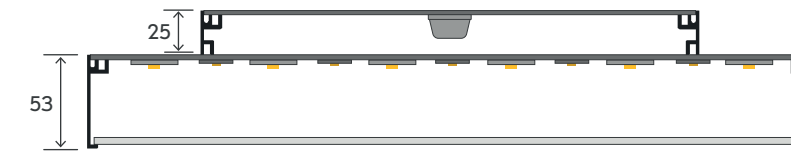

ALABAMA SLIM
REF. 310002
PAG. 66

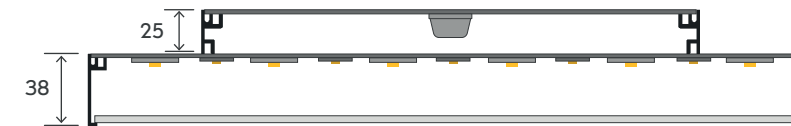

ALABAMA SUPER SLIM | TILT
REF. 310001 | 310007
PAG. 58 | 62

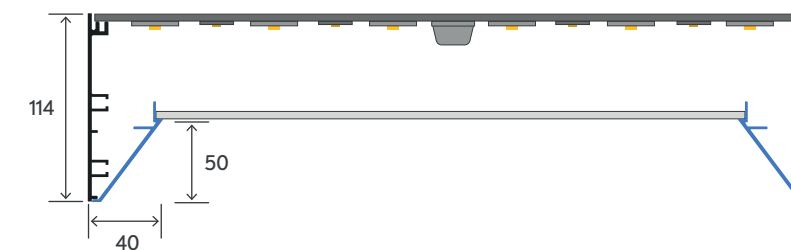

FLORIDA | SQ
REF. 10190 | 10191
PAG. 90 | 94

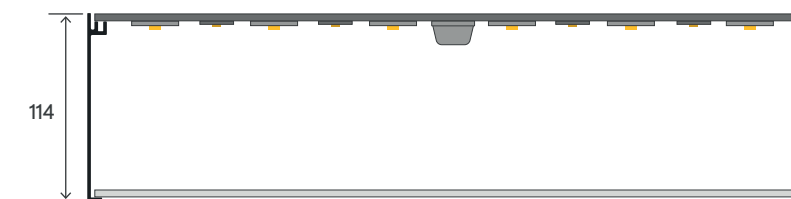

ALTAIR
REF. 10172
PAG. 82

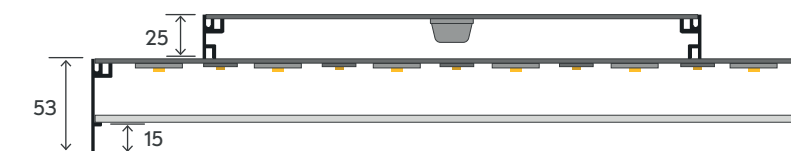

OHIO
REF. 10188
PAG. 86

CONNECTION BOXES

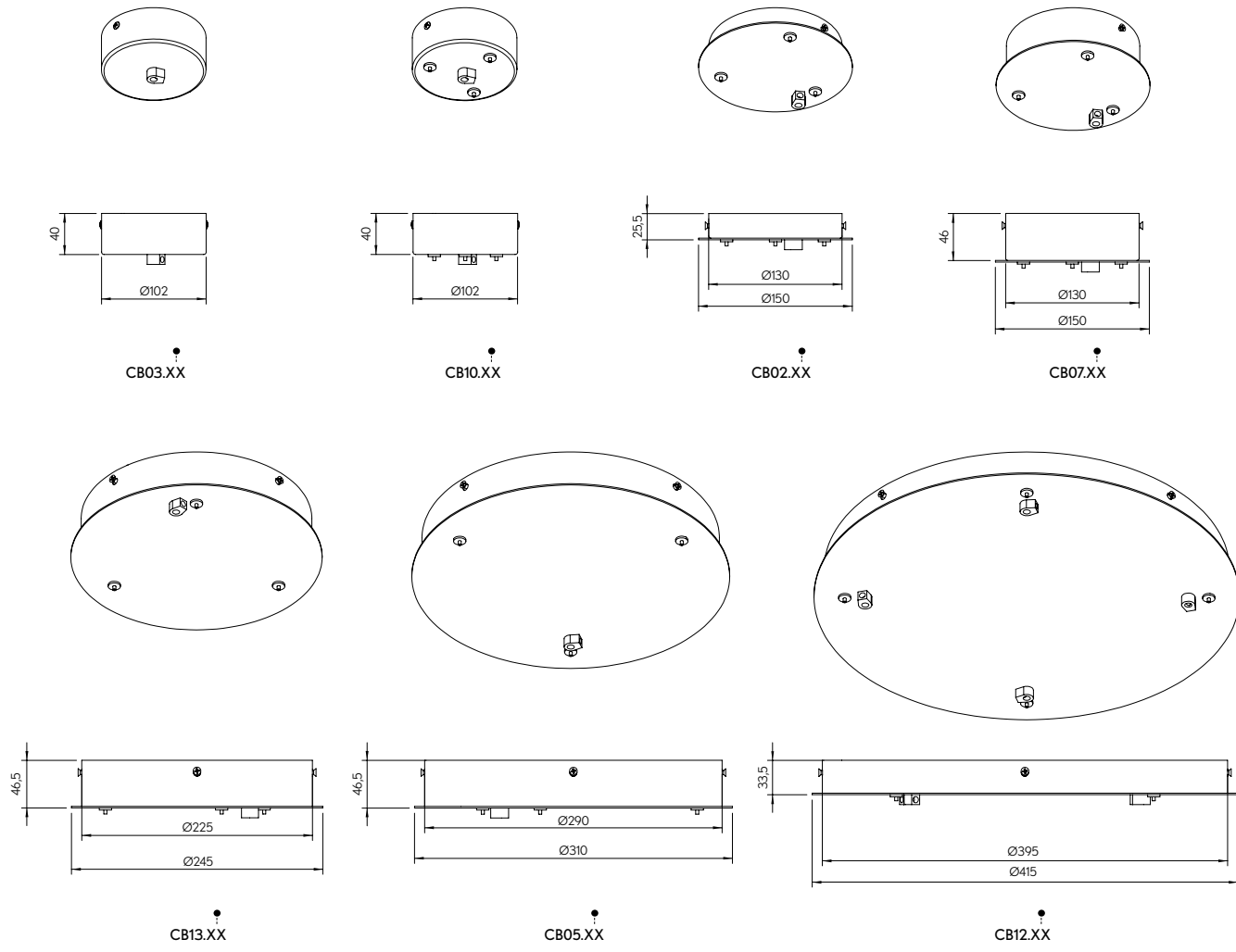

CONNECTION & DRIVER BOXES

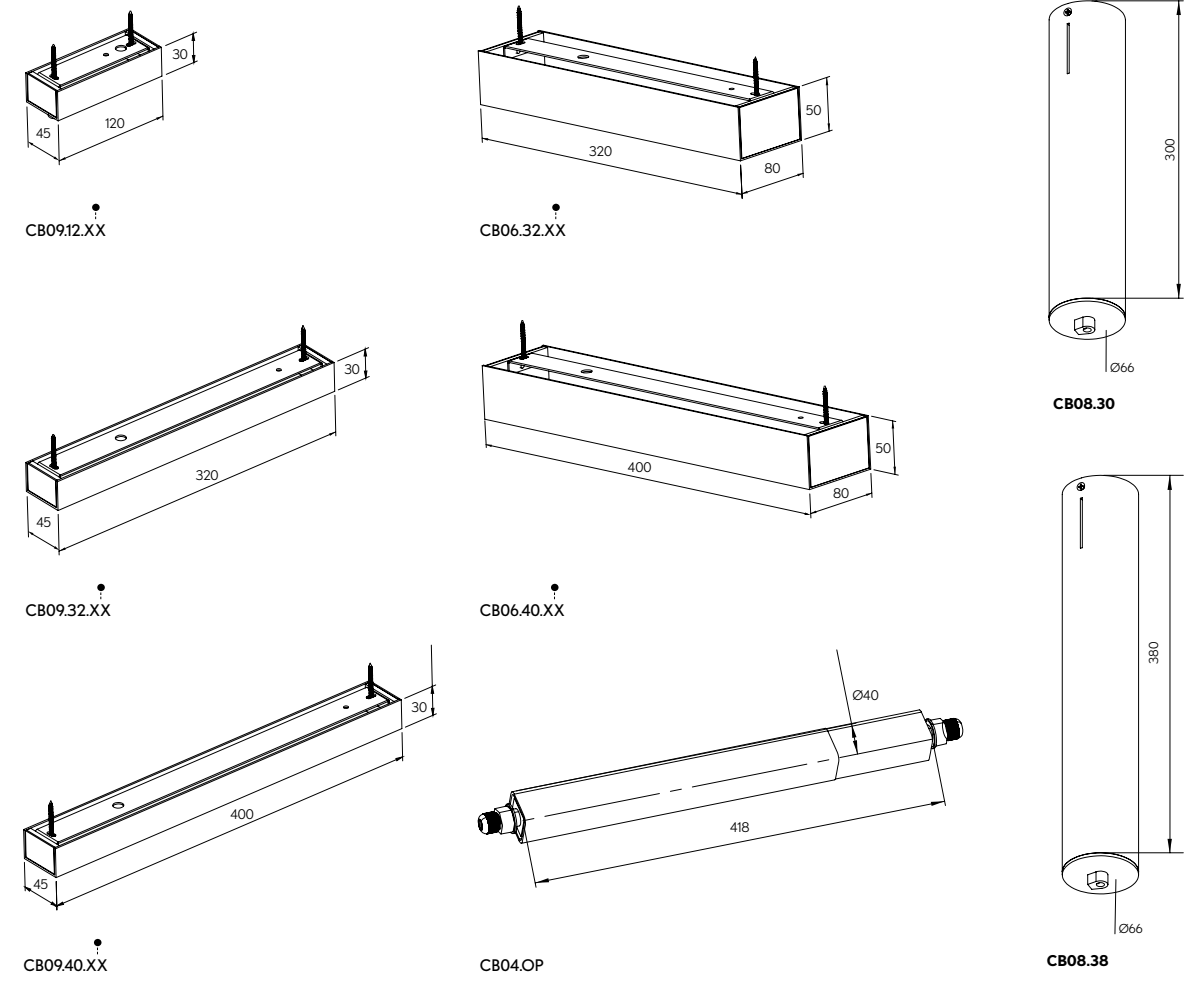

Select finishes



ACCESORIES

SUSPENSION ACCESORIES

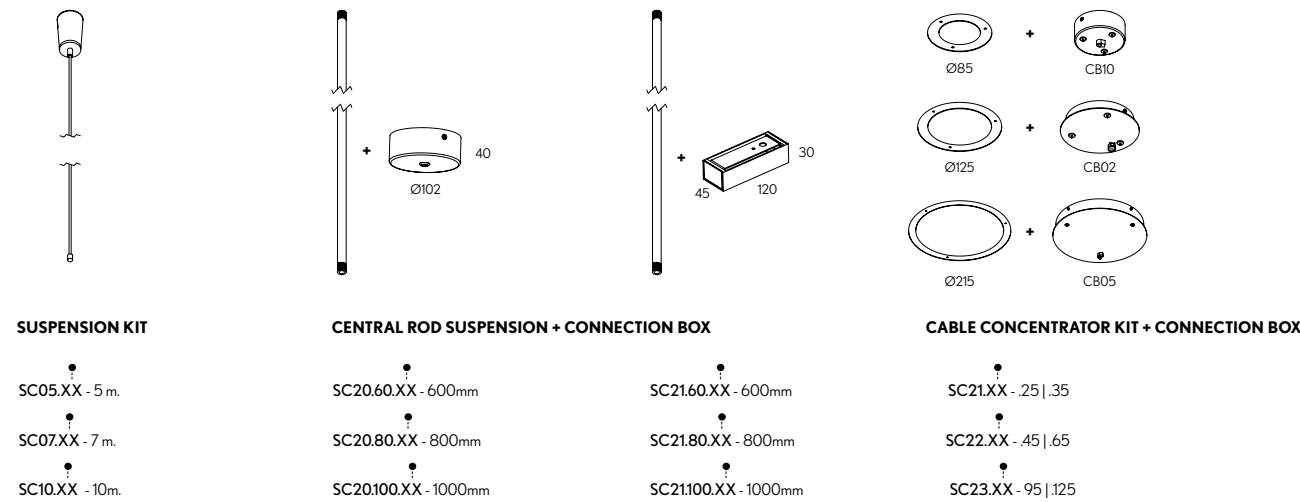

INDIVIDUAL CEILING RECESSED ACCESORIES

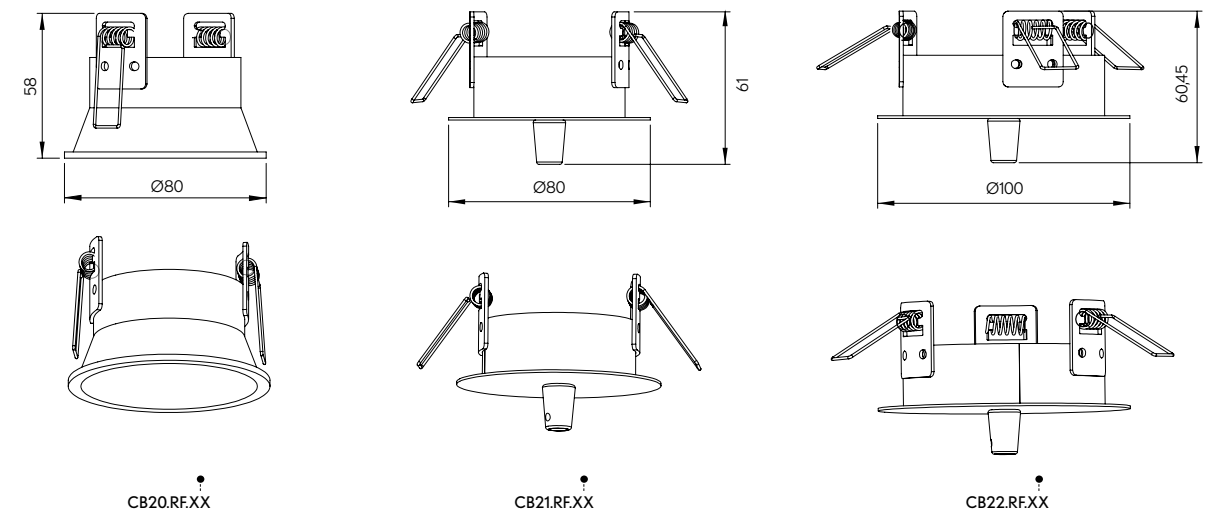

* Check luminaire's compatibility. Consultar compatibilidad con la luminaria.

PENDANT

.PN

ALABAMA SUPER SLIM



new

A bright idea for any room

The ultimate aim: to focus, not distract. Hence the simplicity of the Alabama family. Square or round, whose minimalism conceals an enormous potential to create unique environments.

Alabama luminaries feature extruded aluminium profiles and opal or microprismatic diffusers to provide even light. The result is enveloping, optimal background lighting with scope to play with the intensity of light.

Ambientes con luz propia

La finalidad última: convertir el espacio iluminado en protagonista. De ahí la simplicidad de los modelos que conforman la familia Alabama. Cuadrados o redondos, con relativa sencillez en sus acabados pero con un enorme potencial de crear atmósferas únicas.

Los modelos Alabama se presentan en perfiles de aluminio extruido y difusores opales o micro prismáticos para garantizar una iluminación uniforme y homogénea. Se consigue por ello un ambiente general de iluminación óptima, envolvente, que nos permite jugar con la intensidad de la luz.



new



FINISHES

● COLORS



DIMENSIONS

● DIAMETERS mm. | HEIGHT 38+25mm.
250 | 350 | 450 | 650 | 950 | 1250

LIGHTING OPTIONS

■ DIFFUSERS

OPAL | MICROPRISMATIC

POWERS

STANDARD

CRI

90

COLOR TEMPERATURES

2700K | 3000K | 4000K

▼ DIMMABLE OPTIONS

DALI | 1.10 | PUSH

▲ LIGHT DISTRIBUTION OPTIONS

DOWN | UP-DOWN

LUMINAIRE INCLUDES

.PN

3 x Suspension cables 3m
NON-DIM DOWN: 1 x Feed Hose 3 x 0,75mm²
NON-DIM DOWN-UP: 1 x Feed Hose 5 x 0,75mm² (Ø350 / Ø450 - 2 x Feed Hose 3 x 0,75mm²)
DIM DOWN: 1 x Feed Hose 5 x 0,75mm² (Ø250 - 1 x Feed Hose 3 x 0,75mm²)
DIM DOWN-UP: 1 x Feed Hose 5 x 0,75mm² (Ø350 / Ø450 - 1 x Feed Hose 3 x 0,75mm²)
Connection box CB03 with luminaire's finish

.SR

Surface mounting kit



ON DEMAND

Special RAL Color
Number of switches
Emergency Lighting*
Motion Detection
Wireless Control Options (Casambi)

* Delivered separately
(not installed in luminaire).

INSTALLATIONS



ALABAMA SUPER SLIM

REF 310001.PN | 310001.SR



.PN
PENDANT

·310001 ALABAMA SUPER SLIM
| PN Pag. 58



.SR
SURFACE

·310001 ALABAMA SUPER SLIM
| SR Pag. 58



PENDANT | SURFACE

.SR

.PN

PENDANT | SURFACE

ALABAMA SUPER SLIM	REF.	DIMENSION ▲	FINISH	DIFFUSER ■	POWER	CRI	K	DOWNLIGHT			UPLIGHT ▲UP *1		DIMM ▼	SKETCH
								LUMEN	WATT	mA	LUMEN	WATT		
	310001	.25 *2	●	.OP .MP	.ST	.9	.27	1385	12	250	681	.DA .PU .D1		
								1400			713			9
								1425			765			9
	310001	.35	●	.OP .MP	.ST	.9	.27	2350	19	250	908	.DA .PU .D1		
								2392			950			12
								2697			1020			12
	310001	.45	●	.OP .MP	.ST	.9	.27	4700	38	250	1287	.DA .PU .D1		
								4784			1346			17
								5394			1445			17
	310001	.65	●	.OP .MP	.ST	.9	.27	10572	87	250	1816	.DA .PU .D1		
								10704			1900			24
								12484			2440			24
	310001	.95	●	.OP .MP	.ST	.9	.27	21598	177	250	2724	.DA .PU .D1		
								21976			2850			36
								25816			3060			36
	310001	.125	●	.OP .MP	.ST	.9	.27	36308	350	250	3556	.DA .PU .D1		
								36848			3721			47
								43124			3995			47

Reference order | 310001.XX | .SR | .PN | .XX.XX | .ST9.XX.XX.XX

*1 Uplight (UP) is only available for ON-OFF and DALI dimmable (.DA) options, both in 24VdC. - UP luminaires carry the same color temperature above and below (up-down).
La luz indirecta está solo disponible para versiones on-off y regulación DALI (.DA), ambas en 24VdC. - Las luminarias .UP llevan la misma temperatura de color arriba y abajo (arriba-abajo).
*2 Remote Driver. Driver en remoto.

OPTIONS (.PN)

CABLE CONCENTRATOR	CONNECTION BOX	REF.	FOR MODEL	FINISH		
		CB10	.25 .35	●		
					CB02	.45 .65
					CB05	.95 .125

Reference order | CBXX.XX

CABLE CONCENTRATOR KIT	CONNECTION BOX	REF.	FOR MODEL	FINISH		
		SC21	.25 .35	●		
					SC22	.45 .65
					SC23	.95 .125

Reference order | SCXX.XX

SUSPENSION KIT	REF.	DIMENSION	FINISH
	SC05	5M.	.SA
	SC07	7M.	
	SC10	10M.	

Reference order | SCXX.SA

CENTRAL ROD SUSPENSION*	CONNECTION BOX	REF.	DIMENSIONS	FINISH
		SC20	.60 600mm	●
			.80 800mm	
			.100 1000mm	

Luminaire .95 and .125 require 3 rod suspensions.
Luminarias .95 y .125 requieren 3 tijas.

Reference order | SC20.XX.XX

Select finishes



ALABAMA SUPER SLIM

REF 310001.PN | 310001.SR

SUSPENSION OPTIONS (.PN)

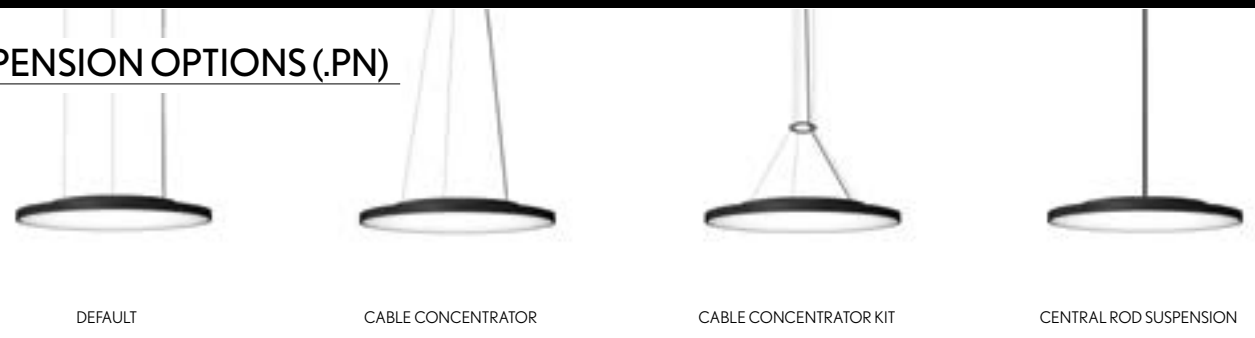

PHOTOMETRY

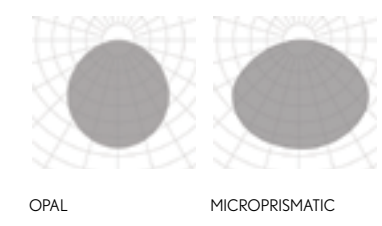

INCLUDED (.PN)

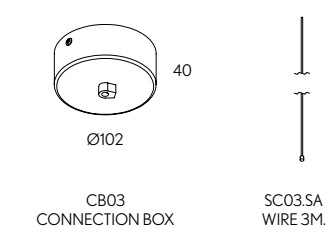

PROFILE

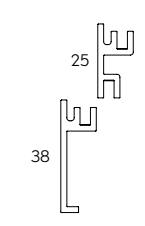



new

FINISHES

● COLORS



DIMENSIONS

● DIAMETERS mm. | HEIGHT 38+25mm.

350 | 450

LIGHTING OPTIONS

■ DIFFUSERS

OPAL | MICROPRISMATIC

POWERS

STANDARD

CRI

90

COLOR TEMPERATURES

2700K | 3000K | 4000K

▼ DIMMABLE OPTIONS

DALI | 1.10 | PUSH

▲ LIGHT DISTRIBUTION OPTIONS

DOWN

LUMINAIRE INCLUDES

Movable component for fastening to the ceiling.
Central Rod Suspension + Connection Box (SC20.60) with luminaire's finish



ON DEMAND

Special RAL Color
Number of switches
Emergency Lighting*
Motion Detection
Wireless Control Options (Casambi)

* Delivered separately
(not installed in luminaire).

INSTALLATIONS



ALABAMA SUPER SLIM TILT

REF310007 .PN



.PN
PENDANT

-310007 ALABAMA SUPER SLIM TILT
| PN - Pag. 62



PENDANT

ALABAMA SUPER SLIM TILT	REF.	DIMENSION	FINISH	DIFFUSER	POWER	CRI	K	LUMEN	WATT	mA	DIMM OP.	SKETCH
	310007	.35	●	.OP .MP	.ST	.9	.27	2350	19	250	.DA .PU .D1	
							.30	2392				
							.40	2697				
	310007	.45	●	.OP .MP	.ST	.9	.27	4700	38	250	.DA .PU .D1	
							.30	4784				
							.40	5394				

Reference order | 310007.XX.PN.XX.XX.ST9.XX.XX

SUSPENSION ROD	REF.	DIMENSIONS	FINISH
	SC20	.80 800mm	●
		.100 1000mm	

Reference order | SC20.XX.XX



PENDANT

• Select finishes

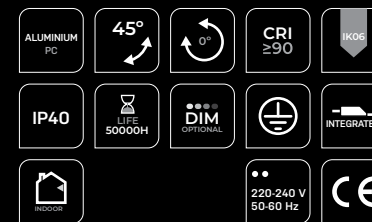

ALABAMA SUPER SLIM TILT

REF 310007.PN

PHOTOMETRY

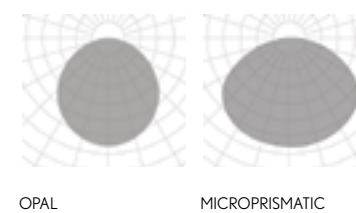

INCLUDED

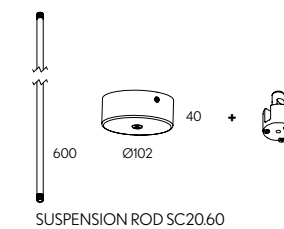

PROFILE

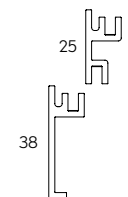



FINISHES

● COLORS



DIMENSIONS

● DIAMETERS mm. | HEIGHT 53+25mm.
250 | 350 | 450 | 650 | 950 | 1250

LIGHTING OPTIONS

■ DIFFUSERS

OPAL | MICROPRISMATIC

POWERS

STANDARD

CRI

90

COLOR TEMPERATURES

2700K | 3000K | 4000K

▼ DIMMABLE OPTIONS

DALI | 1.10 | PUSH

▲ LIGHT DISTRIBUTION OPTIONS

DOWN | UP-DOWN

LUMINAIRE INCLUDES

.PN

3 x Suspension cables 3m
NON-DIM DOWN: 1 x Feed Hose 3 x 0,75mm²
NON-DIM DOWN-UP: 1 x Feed Hose 5 x 0,75mm² (Ø350 / Ø450 - 2 x Feed Hose 3 x 0,75mm²)
DIM DOWN: 1 x Feed Hose 5 x 0,75mm² (Ø250 - 1 x Feed Hose 3 x 0,75mm²)
DIM DOWN-UP: 1 x Feed Hose 5 x 0,75mm² (Ø350 / Ø450 - 1 x Feed Hose 3 x 0,75mm²)
Connection box CB03 with luminaire's finish

.SR

Surface mounting kit



ON DEMAND

Special RAL Color
Number of switches
Emergency Lighting*
Motion Detection
Wireless Control Options (Casambi)

* Delivered separately
(not installed in luminaire).

INSTALLATIONS



ALABAMA SLIM

REF 310002.PN | 310002.SR



.PN
PENDANT

·310002 ALABAMA SLIM | PN
Pag.66



.SR
SURFACE

·310002 ALABAMA SLIM | SR
Pag.66



PENDANT | SURFACE
SR
PN

ALABAMA SLIM	REF.	DIMENSION ▲	FINISH	DIFFUSER ■	POWER	CRI	K	DOWNLIGHT			UPLIGHT ▲UP *1		DIMM ▼	SKETCH
								LUMEN	WATT	mA	LUMEN	WATT		
	310002	.25 *2	●	.OP .MP	.ST	.9	.27	1385	12	250	681	.DA .PU .D1		
								1400			713			9
								1425			765			9
	310002	.35	●	.OP .MP	.ST	.9	.27	2350	19	250	908	.DA .PU .D1		
								2392			950			12
								2697			1020			12
	310002	.45	●	.OP .MP	.ST	.9	.27	4700	38	250	1287	.DA .PU .D1		
								4784			1346			17
								5394			1445			17
	310002	.65	●	.OP .MP	.ST	.9	.27	10572	87	250	1816	.DA .PU .D1		
								10704			1900			24
								12484			2040			24
	310002	.95	●	.OP .MP	.ST	.9	.27	21598	177	250	2724	.DA .PU .D1		
								21976			2850			36
								25816			3060			36
	310002	.125	●	.OP .MP	.ST	.9	.27	36308	350	250	3556	.DA .PU .D1		
								36848			3721			47
								43124			3995			47

Reference order **310002.XX.SR** | **.PN** | **.XX.XX.ST.9.XX.XX.XX**

*1 Uplight (UP) is only available for ON-OFF and DALI dimmable (.DA) options, both in 24VdC. - Upluminaires carry the same color temperature above and below (up-down).
 La luz indirecta está solo disponible para versiones on-off y regulación DALI (.DA), ambas en 24VdC. - Las luminarias .UP llevan la misma temperatura de color arriba y abajo (arriba-abajo).
 *2 Luminaire does not have top driver ring since requires a remote Driver. La luminaria no tiene el anillo superior porque requiere driver en remoto.
 *3 Remote Driver for uplight. Driver en remoto para luz indirecta.

OPTIONS (.PN)

CABLE CONCENTRATOR	CONNECTION BOX	REF.	FOR MODEL	FINISH		
		CB10	.25 .35	●		
					CB02	.45 .65
					CB05	.95 .125

Reference order **CBXX.XX**

CABLE CONCENTRATOR KIT	CONNECTION BOX	REF.	FOR MODEL	FINISH		
		SC21	.25 .35	●		
					SC22	.45 .65
					SC23	.95 .125

Reference order **SCXX.XX**

SUSPENSION KIT	REF.	DIMENSION	FINISH
	SC05	5M.	.SA
	SC07	7M.	
	SC10	10M.	

Reference order **SCXX.SA**

CENTRAL ROD SUSPENSION*	CONNECTION BOX	REF.	DIMENSIONS	FINISH
		SC20	.60 600mm	●
			.80 800mm	
			.100 1000mm	

Luminaire .95 and .125 require 3 rod suspensions.
 Luminarias .95 y .125 requieren 3 tijas.

Reference order **SC20.XX.XX**

Select finishes



- ALUMINUM PC
- 0°
- 360°
- CRI ≥90
- IP40
- LIFE 50000H
- DIM OPTIONAL
- INTEGRATED
- RECORD
- 220-240 V 50-60 Hz
- CE

ALABAMA SLIM

REF 310002.PN | 310002.SR

SUSPENSION OPTIONS (.PN)

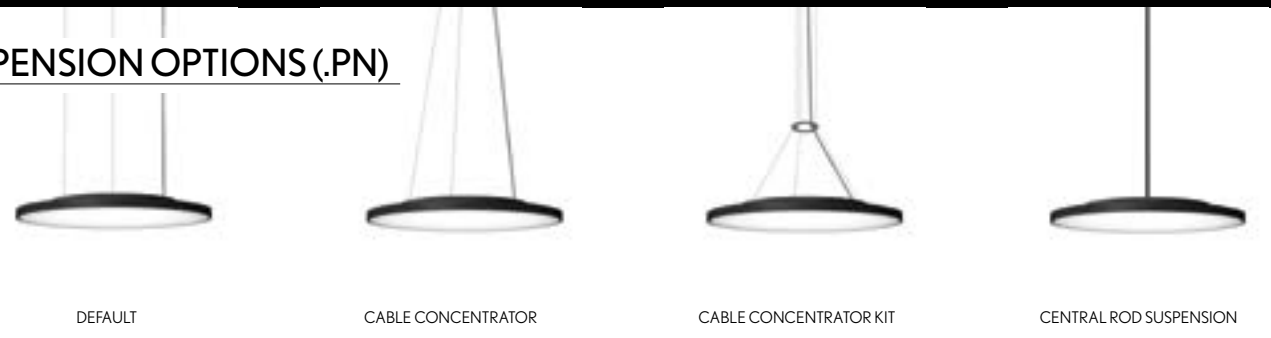

PHOTOMETRY

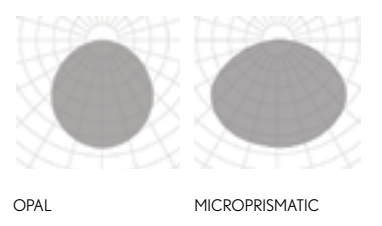

INCLUDED (.PN)

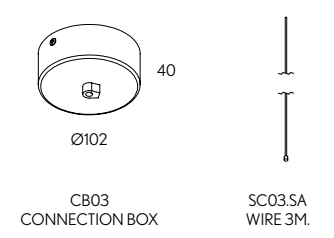

PROFILE

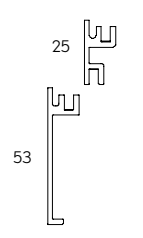



FINISHES

● COLORS



DIMENSIONS

● DIAMETERS mm. | HEIGHT 80 mm.

350 | 450 | 650 | 950 | 1250

LIGHTING OPTIONS

■ DIFFUSERS

OPAL | MICROPRISMATIC

POWERS

STANDARD

CRI

90

COLOR TEMPERATURES

2700K | 3000K | 4000K

▼ DIMMABLE OPTIONS

DALI | 1.10 | PUSH

▲ LIGHT DISTRIBUTION OPTIONS

DOWN | UP-DOWN

LUMINAIRE INCLUDES

.PN

3 x Suspension cables 3m
 NON-DIM DOWN: 1 x Feed Hose 3 x 0,75mm²
 DIM DOWN or NON-DIM DOWN-UP: 1 x Feed Hose 5 x 0,75mm²
 DIM DOWN-UP (only): Cabling 1 circuit, 1 x Feed Hose 5 x 0,75mm²
 Connection box CB03 with luminaire's finish

.SR

Surface mounting kit



ON DEMAND

Special RAL Color
 Number of switches
 Emergency Lighting*
 Motion Detection
 Wireless Control Options (Casambi)

* Delivered separately
 (not installed in luminaire).

INSTALLATIONS



ALABAMA SLIGHT

REF 10192.PN | 10192.SR

.PN
PENDANT

10192 ALABAMA SLIGHT | PN
Pag. 70

.SR
SURFACE

10192 ALABAMA | SR
Pag. 70



PENDANT | SURFACE
 .SR
 .PN

ALABAMA SLIGHT	REF.	DIMEN- SION	FINISH	DIFFUS- ER	POWER	CRI	K	DOWNLIGHT			UPLIGHT ▲UP *1		DIMM ▼	SKETCH
								LUMEN	WATT	mA	LUMEN	WATT		
	10192	.35	●	.OP .MP	.ST	.9	.27	2706	27	700	908	12	.DA .PU .D1	
								2940			950			
								3000			1020			
	10192	.45	●	.OP .MP	.ST	.9	.27	4510	45	700	1287	17	.DA .PU .D1	
								4900			1346			
								5000			1445			
	10192	.65	●	.OP .MP	.ST	.9	.27	10824	109	700	1816	24	.DA .PU .D1	
								11760			1900			
								12000			2040			
	10192	.95	●	.OP .MP	.ST	.9	.27	19844	200	700	2724	36	.DA .PU .D1	
								21560			2850			
								22000			3060			
	10192	.125	●	.OP .MP	.ST	.9	.27	31570	318	700	3556	47	.DA .PU .D1	
								34300			3721			
								35000			3995			

Reference order | 10192.XX|.SR|.PN|.XX.XX|.ST9.XX.XX.XX

OPTIONS (.PN)

CABLE CONCENTRATOR	CONNECTION BOX	REF.	FOR MODEL	FINISH
		CB10	.35	●
		CB02	.45 .65	
		CB05	.95 .125	

Reference order | CBXX.XX

CABLE CONCENTRATOR KIT	CONNECTION BOX	REF.	FOR MODEL	FINISH
		SC21	.35	●
		SC22	.45 .65	
		SC23	.95 .125	

Reference order | SCXX.XX

SUSPENSION KIT	REF.	DIMENSION	FINISH
	SC05	5M.	.SA
	SC07	7M.	
	SC10	10M.	

Reference order | SCXX.SA

CENTRAL ROD SUSPENSION*	CONNECTION BOX	REF.	DIMENSIONS	FINISH
		SC20	.60 600mm	●
			.80 800mm	
			.100 1000mm	

Luminaire .95 and .125 require 3 rod suspensions.
Luminarias .95 y .125 requieren 3 tijas.

Reference order | SC20.XX.XX

*1 Uplight (UP) is only available for ON-OFF and DALI dimmable (.DA) options, both in 24VdC. - UP luminaires carry the same color temperature above and below (up-down).
La luz indirecta está solo disponible para versiones on-off y regulación DALI (.DA), ambas en 24VdC. - Las luminarias UP llevan la misma temperatura de color arriba y abajo (arriba-abajo).

• Select finishes

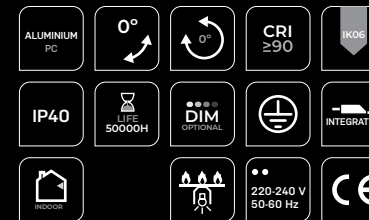

ALABAMA SLIGHT

REF 10192.PN | 10192.SR

SUSPENSION OPTIONS (.PN)

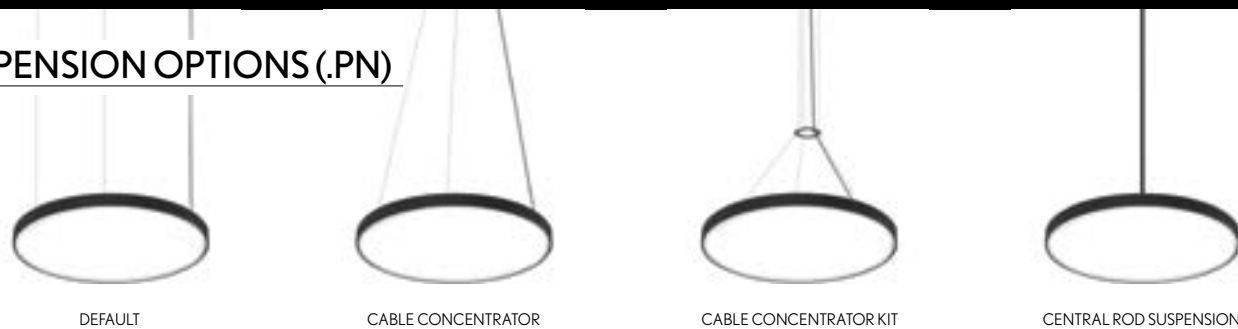

PHOTOMETRY

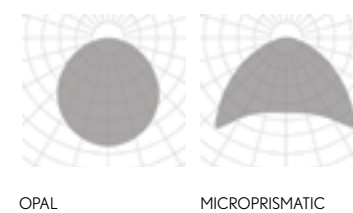

INCLUDED (.PN)

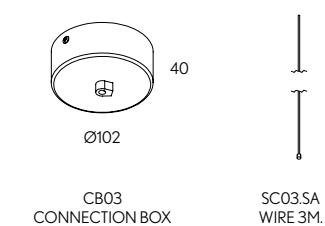

PROFILE

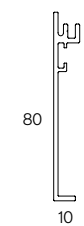

PENDANT | SURFACE

.SR

.PN

PENDANT | SURFACE



FINISHES

● COLORS



DIMENSIONS

- SIZES mm. | HEIGHT 80 mm.
- 350x350 | 450x450 | 650x650 | 950x950 | 1250x1250
- 300 x 650 | 300 x 950 | 300 x 1250

LIGHTING OPTIONS

■ DIFFUSERS

- OPAL | MICROPRISMATIC

POWERS

STANDARD

CRI

90

COLOR TEMPERATURES

2700K | 3000K | 4000K

▼ DIMMABLE OPTIONS

DALI | 1.10 | PUSH

▲ LIGHT DISTRIBUTION OPTIONS

DOWN | UP-DOWN

LUMINAIRE INCLUDES

.PN

4 x Suspension cables 3m
 NON-DIM DOWN: 1x Feed Hose 3 x 0,75mm²
 DIM DOWN or NON-DIM DOWN-UP: 1x Feed Hose 5 x 0,75mm²
 DIM DOWN-UP (only): 1x Feed Hose 5 x 0,75mm²
 Connection box CB09.12 with luminaire's finish

.SR

Surface mounting kit

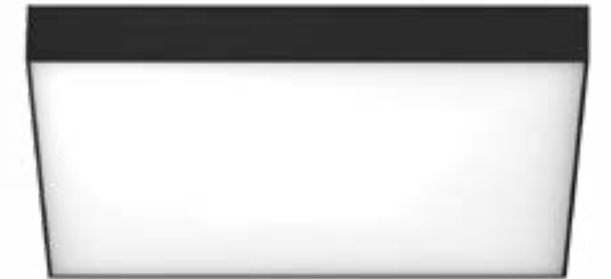

ON DEMAND

Special RAL Color
 Special Color Temperature
 Number of switches
 Emergency Lighting*
 Motion Detection
 Wireless Control Options (Casambi)

* Delivered separately
 (not installed in luminaire).

INSTALLATIONS

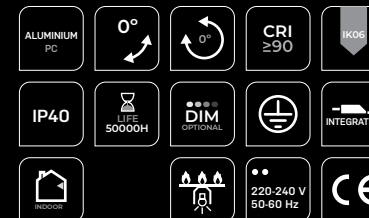

ALABAMA SLIGHT SQ

REF 10194.PN | 10194.SR

.PN
PENDANT

10194 ALABAMA SLIGHT SQ | PN
Pag. 74

.SR
SURFACE

10194 ALABAMA SLIGHT SQ | SR
Pag. 74



.SR
.PN
PENDANT | SURFACE

ALABAMA SLIGHT SQ	REF.	DIMENSION	FINISH	DIFFUSER	POWER	CRI	K	DOWNLIGHT			UPLIGHT ▲UP*1		DIMM ▼	SKETCH
								LUMEN	WATT	mA	LUMEN	WATT		
	10194	.35	●	.OP .MP	.ST	.9	.27	2706	27	700	908	12	.DA .PU .D1	
								2940			950			
								3000			1020			
	10194	.45	●	.OP .MP	.ST	.9	.27	5412	55	700	1287	17	.DA .PU .D1	
								5880			1346			
								6000			1445			
	10194	.65	●	.OP .MP	.ST	.9	.27	10824	109	700	1816	24	.DA .PU .D1	
								11760			1900			
								12000			2040			
	10194	.95	●	.OP .MP	.ST	.9	.27	21648	218	700	2724	36	.DA .PU .D1	
								23520			2850			
								24000			3060			
	10194	.125	●	.OP .MP	.ST	.9	.27	36080	364	700	3556	47	.DA .PU .D1	
								39200			3721			
								40000			3995			

Reference order | 10194.XX.SR.PN.XX.XX.ST9.XX.XX.XX

ALABAMA SLIGHT SQ	REF.	DIMENSION	FINISH	DIFFUSER	POWER	CRI	K	DOWNLIGHT			UPLIGHT ▲UP*		DIMM ▼	SKETCH
								LUMEN	WATT	mA	LUMEN	WATT		
	10194	.30-65	●	.OP .MP	.ST	.9	.27	3608	36	700	705	11	.DA .PU .D1	
								3920			731			
								4000			929			
	10194	.30-95	●	.OP .MP	.ST	.9	.27	5412	55	700	987	15	.DA .PU .D1	
								5880			1023			
								6000			1300			
	10194	.30-125	●	.OP .MP	.ST	.9	.27	7216	73	700	1269	19	.DA .PU .D1	
								7840			1315			
								8000			1671			

OPTIONS (.PN)

Reference order | 10194.XX.PN.XX.XX.XX.XX.XX.XX

SUSPENSION KIT	REF.	DIMENSION	FINISH
	SC05	5M.	.SA
	SC07	7M.	
	SC10	10M.	

Reference order | SCXX.SA

CENTRAL ROD SUSPENSION	CONNECTION BOX	REF.	DIMENSIONS	FINISH
		SC21	.60 600mm	●
			.80 800mm	
			.100 1000mm	

Luminaire .95 and .125 require 2 rod suspensions.
Luminarias .95 y .125 requieren 2 tijas.

Reference order | SC21.XX.XX

*1 Uplight (UP) is only available for ON-OFF and DALI dimmable (.DA) options, both in 24VdC. - UP luminaires carry the same color temperature above and below (up-down).
La luz indirecta está solo disponible para versiones on-off y regulación DALI (.DA), ambas en 24VdC. - Las luminarias UP llevan la misma temperatura de color arriba y abajo (arriba-abajo).

*1 Uplight (UP) is only available for ON-OFF and DALI dimmable (.DA) options, both in 24VdC. La luz indirecta está solo disponible para versiones on-off y regulación DALI (.DA), ambas en 24VdC.

Select finishes



ALABAMA SLIGHT SQ

REF 10194.PN | 10194.SR

SUSPENSION OPTIONS (.PN)

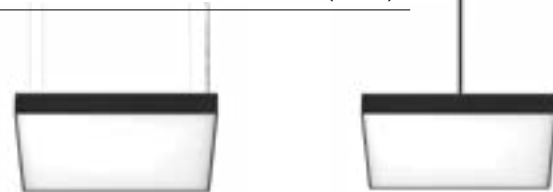

DEFAULT

CENTRAL ROD SUSPENSION

PHOTOMETRY



OPAL

MICROPRISMATIC

INCLUDED (.PN)

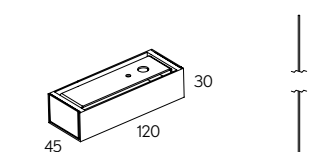

CB0912 CONNECTION BOX

SC03.SA WIRE 3M.

PROFILE

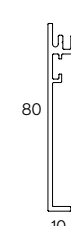

80
10



FINISHES

● COLORS



DIMENSIONS

DIAMETERS mm.	HEIGHT	114 mm.
350 450 650 950 1250		

LIGHTING OPTIONS

■ DIFFUSERS

OPAL | MICROPRISMATIC

POWERS

STANDARD | HIGH

CRI

90

COLOR TEMPERATURES

2700K | 3000K | 4000K | TW

▼ DIMMABLE OPTIONS

DALI | 1.10 | PUSH

▲ LIGHT DISTRIBUTION OPTIONS

DOWN | UP-DOWN

LUMINAIRE INCLUDES

.PN

3 x Suspension cables 3m
 NON-DIM DOWN: 1 x Feed Hose 3 x 0,75mm²
 DIM DOWN or NON-DIM DOWN-UP: 1 x Feed Hose 5 x 0,75mm²
 DIM DOWN-UP (only): 1 x Feed Hose 5 x 0,75mm²
 Connection box CB03 with luminaire's finish

.SR

Surface mounting kit



ON DEMAND

Special RAL Color
 Special Color Temperature
 Number of switches
 Emergency Lighting*
 CRI 80
 Motion Detection
 RGB
 Wireless Control Options (Casambi)

* Delivered separately
 (not installed in luminaire).

INSTALLATIONS



REF 10158.PN | 10158.SR

.PN
 PENDANT

·10158 ALABAMA | PN
 Pag. 78

.SR
 SURFACE

·10158 ALABAMA | SR
 Pag. 78

.RF
 RECESSED FRAME

·10158 ALABAMA | RF
 Pag. 396

.TR
 TRIMLESS

·10158 ALABAMA | TR
 Pag. 580

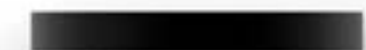

ALABAMA	REF.	DIMENSION	FINISH	DIFFUSER	POWER	CRI	K	DOWNLIGHT			UPLIGHT ▲.UP*2		DIMM ▼	SKETCH								
								LUMEN	WATT	mA	LUMEN	WATT										
	10158	.35	●	.OP .MP	.ST	.9	.27	2295	18	500	908	12	.DA .PU .D1									
								2385			950											
								2475			1020											
								.8 TW*1			-				-							
								.HI			.9				.27	4590	35	500	908	12	.DA .PU .D1	
																4767			950			
		4956	1020																			
			10158	.45	●	.OP .MP	.ST	.9	.27	4590	35	500	1287		17	.DA .PU .D1						
										4770			1346									
										4950			1445									
										.8 TW*1			11400-11820					76	700	-	-	
										.HI			.9					.27	9180	71	500	1287
9534	1346																					
9912	1445																					
	10158			.65	●	.OP .MP	.ST	.9	.27	9180	71	500	1816	24	.DA .PU .D1							
										9540			1900									
										9900			2040									
										.8 TW*1			22800-23640					152	700	-	-	
										.HI			.9					.27	18360	142	500	1816
		19068	1900																			
		19824	2040																			
			10158	.95	●	.OP .MP	.ST	.9	.27	16830	130	500	2724	36	.DA .PU .D1							
										17490			2850									
										18150			3060									
										.8 TW*1			41800-43340					279	700	-	-	
										.HI			.9					.27	33660	260	500	2724
34958	2850																					
36344	3060																					
	10158			.125	●	.OP .MP	.ST	.9	.27	27540	212	500	3556	47	.DA .PU .D1							
										28620			3721									
										29700			3995									
										.8 TW*1			68400-70920					457	700	-	-	
										.HI			.9					.27	55080	425	500	3556
		57204	3721																			
		59472	3995																			

Reference order 10158.XX.SR.XX.XX.XX.XX.XX.XX.XX.XX.XX

OPTIONS (.PN)

CABLE CONCENTRATOR	CONNECTION BOX	REF.	FOR MODEL	FINISH
		CB10	.35	●
		CB02	.45 .65	
		CB05	.95 .125	

Reference order CBXX.XX

CABLE CONCENTRATOR KIT	CONNECTION BOX	REF.	FOR MODEL	FINISH
		SC21	.35	●
		SC22	.45 .65	
		SC23	.95 .125	

Reference order SCXX.XX

SUSPENSION KIT	REF.	DIMENSION	FINISH
	SC05	5M.	.SA
	SC07	7M.	
	SC10	10M.	

Reference order SCXX.SA

CENTRAL ROD SUSPENSION*	CONNECTION BOX	REF.	DIMENSIONS	FINISH
		SC20	.60 600mm	●
			.80 800mm	
			.100 1000mm	

Luminaire .95 and .125 require 3 rod suspensions.
Luminarias .95 y .125 requieren 3 tijas.

Reference order SC20.XX.XX

ALABAMA

REF 10158.PN | 10158.SR

● Select finishes

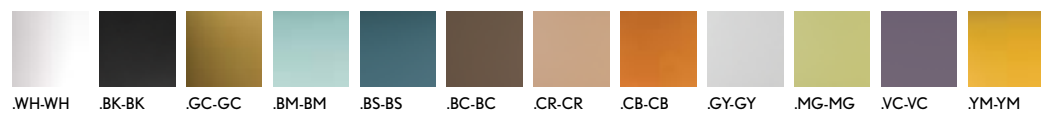

*1 Tunable White (TW) values correspond to 2700K and 6500K - TW is only available for DALI DT8 dimmable (DA), CRI 80 (8) 700mA. Los valores del blanco dinámico (TW) corresponden a 2700K y 6500K. - TW solo está disponible con protocolo DALI DT8 (DA), CRI 80 (8) 700mA.

*2 Uplight (UP) is only available for ON-OFF and DALI dimmable (DA) options, both in 24VdC. - UP luminaires carry the same color temperature above and below (up-down). La luz indirecta está solo disponible para versiones on-off y regulación DALI (DA), ambas en 24VdC. - Las luminarias UP llevan la misma temperatura de color arriba y abajo (arriba-abajo).

*3 Indirect Lighting UP uplight shares equal lumen output for .ST and .HI versions. La luz indirecta UP comparte la misma salida de lúmenes para las versiones .ST y .HI.

PHOTOMETRY

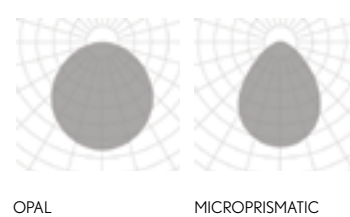

INCLUDED (.PN)

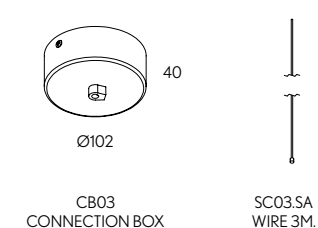

PROFILE

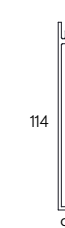



FINISHES

● COLORS



DIMENSIONS

● SIZES mm. | HEIGHT 114 mm.
400x400 | 600x600 | 900x900 | 1200x1200

LIGHTING OPTIONS

■ DIFFUSERS

OPAL | MICROPRISMATIC

POWERS

STANDARD | HIGH

CRI

90

COLOR TEMPERATURES

2700K | 3000K | 4000K | TW

▼ DIMMABLE OPTIONS

DALI | 1.10 | PUSH

▲ LIGHT DISTRIBUTION OPTIONS

DOWN | UP-DOWN

LUMINAIRE INCLUDES

.PN

4 x Suspension cables 3m
NON-DIM DOWN: 1x Feed Hose 3 x 0,75mm²
DIM DOWN or NON-DIM DOWN-UP: 1x Feed Hose 5 x 0,75mm²
DIM DOWN-UP (only): 1x Feed Hose 5 x 0,75mm²
Connection box CB09.12 with luminaire's finish

.SR

Surface mounting kit



ON DEMAND

Special RAL Color
Special Color Temperature
Number of switches
Emergency Lighting*
CRI 80
Motion Detection
RGB
Wireless Control Options (Casambi)

* Delivered separately
(not installed in luminaire).

INSTALLATIONS



ALTAIR

REF 10172.PN | 10172.SR



.PN
PENDANT

·10172 ALTAIR | PN
Pag. 82



.SR
SURFACE

·10172 ALTAIR | SR
Pag. 82

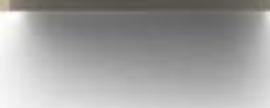

.TR
TRIMLESS

·10172 ALTAIR | TR
Pag. 584

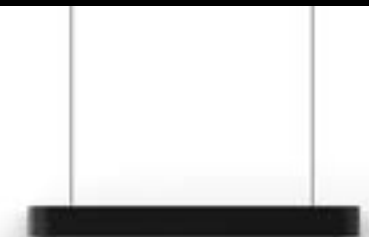

PENDANT | SURFACE
SR
PN

PENDANT | SURFACE

ALTAIR	REF.	DIMENSIONS	FINISH	DIFFUSER	POWER	CRI	K	DOWNLIGHT			UPLIGHT ▲ UP *2		DIMM ▼	SKETCH		
								LUMEN	WATT	mA	LUMEN	WATT				
	10172	.45	●	.OP .MP	.ST	.9	.27	3825	24	500	1287	17	.DA .PU .D1			
							.30	3975			1346					
							.40	4125			1445					
							.HI	.9	.27	7600 - 7880	51	700	-		-	.DA
									.30	6120	47	500	1287			
									.40	6356			1346			
		.40	6608			1445										
	10172	.65	●	.OP .MP	.ST	.9	.27	6120	47	500	1816	24	.DA .PU .D1			
							.30	6360			1900					
							.40	6600			2040					
							.HI	.9	.27	15200 - 15760	102	700	-		-	.DA
									.30	12240	94	500	1816			
									.40	12712			1900			
		.40	13216			2040										
	10172	.95	●	.OP .MP	.ST	.9	.27	11475	89	500	2724	36	.DA .PU .D1			
							.30	11925			2850					
							.40	12375			3060					
							.HI	.9	.27	28500 - 29550	191	700	-		-	.DA
									.30	22950	177	500	2724			
									.40	23835			2850			
		.40	24780			3060										
	10172	.125	●	.OP .MP	.ST	.9	.27	18360	142	500	3556	47	.DA .PU .D1			
							.30	19080			3721					
							.40	19800			3995					
							.HI	.9	.27	45600 - 47280	305	700	-		-	.DA
									.30	36720	283	500	3556			
									.40	38136			3721			
		.40	39648			3995										

Reference order | 10172.XX | .SR | .PN | .XX.XX.XX.XX.XX.XX



.SR
.PN
PENDANT | SURFACE

• Select finishes



ALTAIR

REF 10172.PN | 10172.SR

PHOTOMETRY

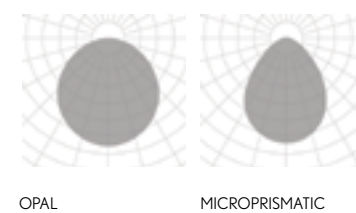

INCLUDED (.PN)

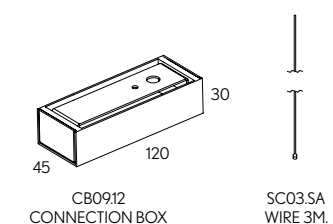

PROFILE



*1 Tunable White (TW) values correspond to 2700K and 6500K - TW is only available for DALI DT8 dimmable (.DA), CRI 80 (8) 700mA. Los valores del blanco dinámico (TW) corresponden a 2700K y 6500K. -TW solo está disponible con protocolo DALI DT8 (DA), CRI 80 (8) 700mA.

*2 Uplight (UP) is only available for ON-OFF and DALI dimmable (.DA) options, both in 24VdC. - UP luminaires carry the same color temperature above and below (up-down). La luz indirecta está solo disponible para versiones on-off y regulación DALI (DA), ambas en 24VdC. - Las luminarias .UP llevan la misma temperatura de color arriba y abajo (arriba-abajo).

*3 Indirect Lighting .UP uplight shares equal lumen output for .ST and .HI versions. La luz indirecta .UP comparte la misma salida de lúmenes para las versiones .ST y .HI.



FINISHES

● COLORS



DIMENSIONS

● DIAMETERS mm. | HEIGHT 78 mm.

350 | 450 | 650 | 950 | 1250

LIGHTING OPTIONS

■ DIFFUSERS

OPAL | MICROPRISMATIC

POWERS

STANDARD

CRI

90

COLOR TEMPERATURES

2700K | 3000K | 4000K

▼ DIMMABLE OPTIONS

DALI | 1.10 | PUSH

▲ LIGHT DISTRIBUTION OPTIONS

DOWN | UP-DOWN

LUMINAIRE INCLUDES

.PN

3 x Suspension cables 3m
 NON-DIM DOWN: 1 x Feed Hose 3 x 0,75mm²
 NON-DIM DOWN-UP: 1 x Feed Hose 5 x 0,75mm² (Ø350 / Ø450 - 2 x Feed Hose 3 x 0,75mm²)
 DIM DOWN: 1 x Feed Hose 5 x 0,75mm² (Ø250 - 1 x Feed Hose 3 x 0,75mm²)
 DIM DOWN-UP: 1 x Feed Hose 5 x 0,75mm² (Ø350 / Ø450 - 1 x Feed Hose 3 x 0,75mm²)
 Connection box CB03 with luminaire's finish

.SR

Surface mounting kit



ON DEMAND

Special RAL Color
 Special Color Temperature
 Number of switches
 Emergency Lighting*
 Motion Detection
 Wireless Control Options (Casambi)

* Delivered separately
 (not installed in luminaire).

INSTALLATIONS



OHIO

REF 10188.PN | 10188.SR



OHIO	REF.	DIMENSION ▲	FINISH	DIFFUSER ■	POWER	CRI	K	DOWNLIGHT			UPLIGHT ▲ Up *1*2		DIMM ▼	SKETCH
								LUMEN	WATT	mA	LUMEN	WATT		
	10188	.35	●	.OP .MP	.ST	.9	.27	2350	19	250	908	.DA .PU .D1		
								2392			12			
								2697			1020			
	10188	.45	●	.OP .MP	.ST	.9	.27	4700	38	250	1287	.DA .PU .D1		
								4784			17			
								5394			1445			
	10188	.65	●	.OP .MP	.ST	.9	.27	10572	87	250	1816	.DA .PU .D1		
								10704			24			
								12484			2040			
	10188	.95	●	.OP .MP	.ST	.9	.27	21598	177	250	2724	.DA .PU .D1		
								21976			36			
								25816			3060			
	10188	.125	●	.OP .MP	.ST	.9	.27	36308	350	250	3556	.DA .PU .D1		
								36848			47			
								43124			3995			

Reference order | 10188.XX .SR .PN .XX.XX .ST9.XX.XX

OPTIONS (.PN)

CABLE CONCENTRATOR	CONNECTION BOX	REF.	FOR MODEL	FINISH
		CB10	.25 .35	●
		CB02	.45 .65	
		CB05	.95 .125	

Reference order | CBXX.XX

CABLE CONCENTRATOR KIT	CONNECTION BOX	REF.	FOR MODEL	FINISH
		SC21	.25 .35	●
		SC22	.45 .65	
		SC23	.95 .125	

Reference order | SCXX.XX

SUSPENSION KIT	REF.	DIMENSION	FINISH
	SC05	5M.	.SA
	SC07	7M.	
	SC10	10M.	

Reference order | SCXX.SA

CENTRAL ROD SUSPENSION*	CONNECTION BOX	REF.	DIMENSIONS	FINISH
		SC20	.60 600mm	●
			.80 800mm	
			.100 1000mm	

Luminaire .95 and .125 require 3 rod suspensions.
Luminarias .95 y .125 requieren 3 tijas.

Reference order | SC20.XX.XX

*1 Uplight (UP) is only available for ON-OFF and DALI dimmable (DA) options, both in 24VdC. - UP luminaires carry the same color temperature above and below (up-down).
La luz indirecta está solo disponible para versiones on-off y regulación DALI (DA), ambas en 24VdC. - Las luminarias UP llevan la misma temperatura de color arriba y abajo (arriba-abajo).
*2 Remote Driver for uplight. Driver en remoto para luz indirecta.

Select finishes



OHIO

REF 10188.PN | 10188.SR

SUSPENSION OPTIONS (.PN)

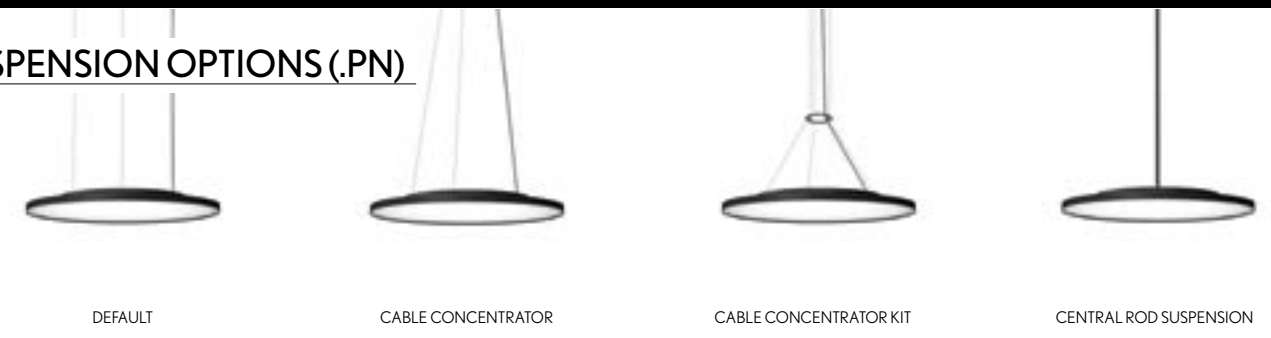

PHOTOMETRY

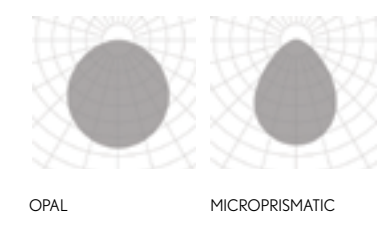

INCLUDED (.PN)

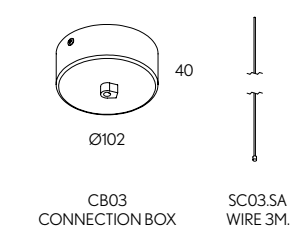

PROFILE

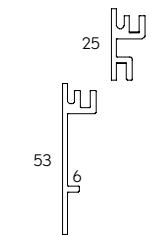



FINISHES

EXTERNAL COLOR



INTERNAL COLOR



DIMENSIONS

DIAMETERS mm. | HEIGHT 114 mm.

450 | 650 | 950 | 1250

LIGHTING OPTIONS

DIFFUSERS

OPAL | MICROPRISMATIC

POWERS

STANDARD

CRI

90

COLOR TEMPERATURES

2700K | 3000K | 4000K

DIMMABLE OPTIONS

DALI | 1.10 | PUSH

LIGHT DISTRIBUTION OPTIONS

DOWN | UP-DOWN

LUMINAIRE INCLUDES

.PN

3 x Suspension cables 3m
 NON-DIM DOWN: 1x Feed Hose 3 x 0,75mm²
 DIM DOWN or NON-DIM DOWN-UP: 1x Feed Hose 5 x 0,75mm²
 DIM DOWN-UP (only): 1x Feed Hose 5 x 0,75mm²
 Connection box CB03 with luminaire's finish

.SR

Surface mounting kit



ON DEMAND

Special RAL Color
 Number of switches
 Emergency Lighting*
 Motion Detection
 Wireless Control Options (Casambi)

* Delivered separately
 (not installed in luminaire).

INSTALLATIONS



FLORIDA

REF 10190.PN | 10190.SR

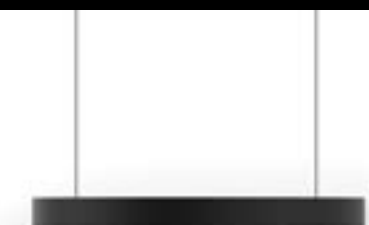

PENDANT | SURFACE

.SR

.PN

PENDANT | SURFACE

FLORIDA	REF.	DIMENSION	FINISH	DIFFUSER	POWER	CRI	K	DOWNLIGHT			UPLIGHT ▲UP *1		DIMM ▼	SKETCH
								LUMEN	WATT	MA	LUMEN	WATT		
	10190	.45	●	.OP .MP	.ST	.9	.27	4510	45	700	1287	17	.DA .PU .D1	
								4900			1346			
								5000			1445			
	10190	.65	●	.OP .MP	.ST	.9	.27	10824	109	700	1816	24	.DA .PU .D1	
								11760			1900			
								12000			2040			
	10190	.95	●	.OP .MP	.ST	.9	.27	19844	200	700	2724	36	.DA .PU .D1	
								21560			2850			
								22000			3060			
	10190	.125	●	.OP .MP	.ST	.9	.27	31570	318	700	3556	47	.DA .PU .D1	
								34300			3721			
								35000			3995			

Reference order | 10190.XX | .SR | .PN | .XX.XX | .ST9.XX.XX

OPTIONS (.PN)

CABLE CONCENTRATOR	CONNECTION BOX	REF.	FOR MODEL	FINISH
		CB02	.45 .65	●

Reference order | CBXX.XX

CABLE CONCENTRATOR KIT	CONNECTION BOX	REF.	FOR MODEL	FINISH
		SC22	.45 .65	●

Reference order | SCXX.XX

SUSPENSION KIT	REF.	DIMENSION	FINISH
	SC05	5M.	.SA
	SC07	7M.	
	SC10	10M.	

Reference order | SCXX.SA

CENTRAL ROD SUSPENSION*	CONNECTION BOX	REF.	DIMENSIONS	FINISH
		SC20	.60 600mm	●
			.80 800mm	
			.100 1000mm	

Reference order | SC20.XX.XX

* Luminaire .95 and .125 require 3 rod suspensions. Luminarias .95 y .125 requieren 3 tijas.

*1 Uplight (UP) is only available for ON-OFF and DALI dimmable (.DA) options, both in 24VdC. - UP luminaires carry the same color temperature above and below (up-down).
La luz indirecta está solo disponible para versiones on-off y regulación DALI (.DA), ambas en 24VdC. - Las luminarias .UP llevan la misma temperatura de color arriba y abajo (arriba-abajo).

• Select finishes



FLORIDA

REF 10190.PN | 10190.SR

SUSPENSION OPTIONS (.PN)

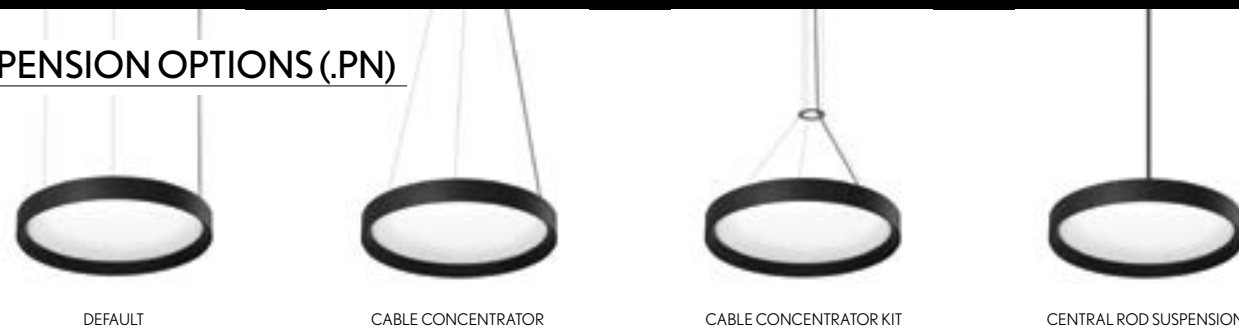

PHOTOMETRY

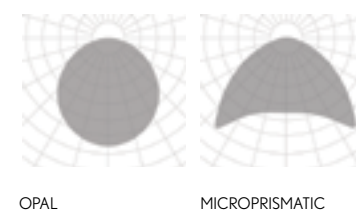

INCLUDED (.PN)

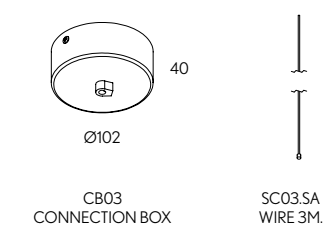

PROFILE

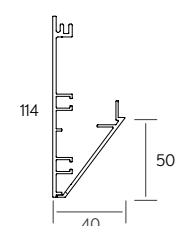

SR
PN
PENDANT | SURFACE



FINISHES

EXTERNAL COLOR



INTERNAL COLOR



DIMENSIONS

- SIZES mm. | HEIGHT 114 mm.
- 350x350 | 450x450 | 650x650 | 950x950 | 1250x1250

LIGHTING OPTIONS

DIFFUSERS

- OPAL | MICROPRISMATIC

POWERS

- STANDARD

CRI

- 90

COLOR TEMPERATURES

- 2700K | 3000K | 4000K

▼ DIMMABLE OPTIONS

- DALI | 1.10 | PUSH

▲ LIGHT DISTRIBUTION OPTIONS

- DOWN | UP-DOWN

LUMINAIRE INCLUDES

.PN

- 4 x Suspension cables 3m
- NON-DIM DOWN: 1 x Feed Hose 3 x 0,75mm²
- DIM DOWN or NON-DIM DOWN-UP: 1 x Feed Hose 5 x 0,75mm²
- DIM DOWN-UP (only): 1 x Feed Hose 5 x 0,75mm²
- Connection box CB09.12 with luminaire's finish

.SR

- Surface mounting kit

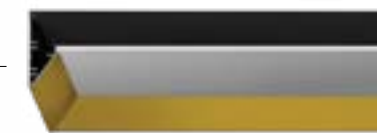

ON DEMAND

- Special RAL Color
- Number of switches
- Emergency Lighting*
- Motion Detection
- Wireless Control Options (Casambi)

* Delivered separately (not installed in luminaire).

INSTALLATIONS

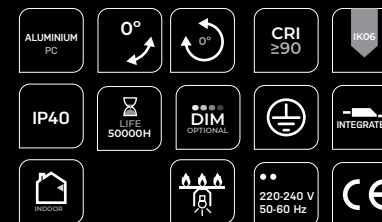

FLORIDA SQ

REF 10191.PN | 10191.SR

.PN
PENDANT

·10191 FLORIDA SQ | PN
Pag. 94

.SR
SURFACE

·10191 FLORIDA SQ | SR
Pag. 94

.RF
RECESSED FRAME

·10191 FLORIDA SQ | RF
Pag. 412

.TR
TRIMLESS

·10191 FLORIDA SQ | TR
Pag. 600

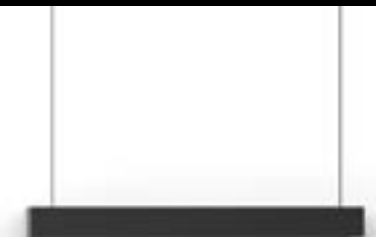

.SR

.PN

PENDANT | SURFACE

FLORIDA SQ	REF.	DIMEN- SION ▲	FINISH	DIFFUS- ER ■	POWER	CRI	K	DOWNLIGHT			UPLIGHT ▲UP *1		DIMM ▼	SKETCH
								LUMEN	WATT	mA	LUMEN	WATT		
	10191	.35	●	.OP .MP	.ST	.9	.27	2706	27	700	908	12	.DA .PU .D1	
							.30	2940			950			
							.40	3000			1020			
	10191	.45	●	.OP .MP	.ST	.9	.27	5412	55	700	1287	17	.DA .PU .D1	
							.30	5880			1346			
							.40	6000			1445			
	10191	.65	●	.OP .MP	.ST	.9	.27	10824	109	700	1816	24	.DA .PU .D1	
							.30	11760			1900			
							.40	12000			2040			
	10191	.95	●	.OP .MP	.ST	.9	.27	21648	218	700	2724	36	.DA .PU .D1	
							.30	23520			2850			
							.40	24000			3060			
	10191	.125	●	.OP .MP	.ST	.9	.27	36080	364	700	3556	47	.DA .PU .D1	
							.30	39200			3721			
							.40	40000			3995			

Reference order | 10191.XX | .SR | .PN | .XX.XX | .ST9.XX.XX.XX



*1 Uplight (UP) is only available for ON-OFF and DALI dimmable (DA) options, both in 24VdC. - U.P luminaires carry the same color temperature above and below (up-down).
La luz indirecta está solo disponible para versiones on-off y regulación DALI (DA), ambas en 24VdC. - Las luminarias .UP llevan la misma temperatura de color arriba y abajo (arriba-abajo).

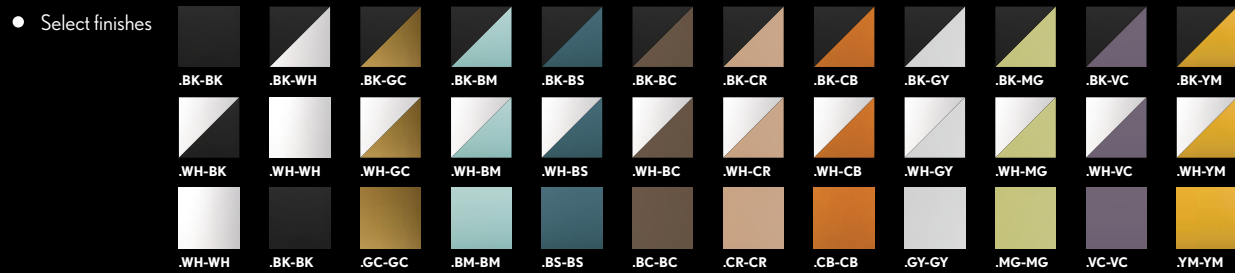

FLORIDA SQ

REF 10191.PN | 10191.SR

PHOTOMETRY

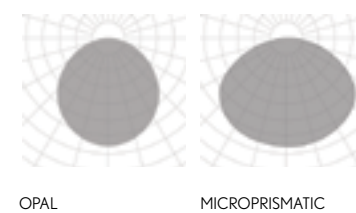

INCLUDED (.PN)

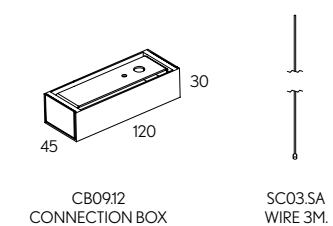

PROFILE

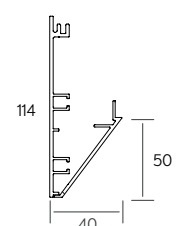

PENDANT | SURFACE

.SR
.PN

new



FINISHES

● COLORS



DIMENSIONS

● DIAMETERS mm. | HEIGHT 50 mm.

250 | 350 | 450 | 650 | 950 | 1250

LIGHTING OPTIONS

■ DIFFUSERS

SILICONE

POWERS

STANDARD

CRI

90

COLOR TEMPERATURES

2700K | 3000K | 4000K

▼ DIMMABLE OPTIONS

DALI | 1.10 | PUSH

▲ LIGHT DISTRIBUTION OPTIONS

INSIDE

LUMINAIRE INCLUDES

.PN

3 x Suspension cables 3m
DIM or NON-DIM: 1 x Feed Hose 3 x 0,75mm²

.SR

Surface mounting kit



ON DEMAND
Special RAL Color
Tunable White
RGB
Other Dimensions



PENDANT | SURFACE
SR
PN

INSTALLATIONS

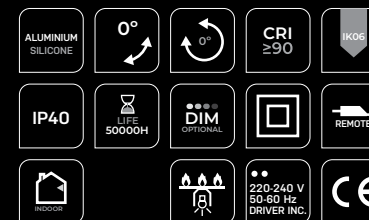

ALBERTA INSIDE

REF 10243.PN | 10243.SR

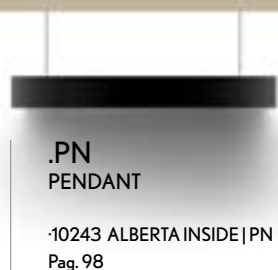

.PN
PENDANT

· 10243 ALBERTA INSIDE | PN
Pag. 98



.SR
SURFACE

· 10243 ALBERTA INSIDE | SR
Pag. 98

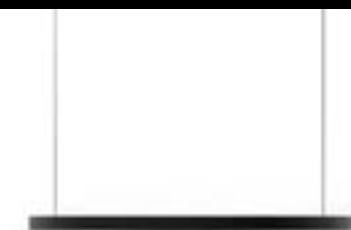
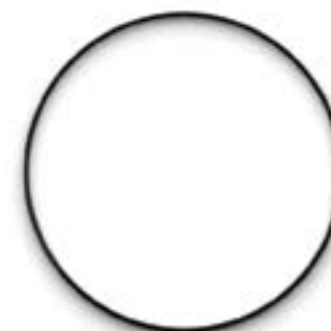

ALBERTA INSIDE	REF.	DIMENSION	FINISH	DIFFUSER OPTIONS	POWER	CRI	K	LUMEN MAX.	WATT	VdC	DIMM OPT.	SKETCH
	10243	.25	●	.SI	.ST	.9	.27	2418	23	24	.DA .PU .D1	
							.30	2496				
							.40	2574				
	10243	.35	●	.SI	.ST	.9	.27	3407	32	24	.DA .PU .D1	
							.30	3517				
							.40	3627				
	10243	.45	●	.SI	.ST	.9	.27	4371	41	24	.DA .PU .D1	
							.30	4512				
							.40	4653				
	10243	.65	●	.SI	.ST	.9	.27	6324	59	24	.DA .PU .D1	
							.30	6528				
							.40	6732				
	10243	.95	●	.SI	.ST	.9	.27	9238	86	24	.DA .PU .D1	
							.30	9536				
							.40	9834				
	10243	.125	●	.SI	.ST	.9	.27	12152	113	24	.DA .PU .D1	
							.30	12544				
							.40	12936				

Reference order | 10243.XX | .SR | .PN | .XX.SI.ST9.XX.XX

OPTIONS (.PN)

CABLE CONCENTRATOR	CONNECTION BOX	REF.	FOR MODEL	FINISH
		CB10	.25 .35	●
		CB02	.45 .65	
		CB05	.95 .125	

Reference order | CBXX.XX

SUSPENSION KIT	REF.	DIMENSION	FINISH
	SC05	5M.	.SA
	SC07	7M.	
	SC10	10M.	

Reference order | SCXX.SA

CABLE CONCENTRATOR KIT	CONNECTION BOX	REF.	FOR MODEL	FINISH
		SC21	.25 .35	●
		SC22	.45 .65	
		SC23	.95 .125	

Reference order | SCXX.XX

BOXES (.PN) Not-included, please select:

CONNECTION BOX AND DRIVER BOX FOR REMOTE DRIVER		DRIVER BOX NON-DIMM		DRIVER BOX DIMMABLE		FINISH
						●
CB03	CB04.OP*	CB08.30	CB06.32	CB08.38	CB06.40	

*No finish color, use this reference as it is (CB04.OP).
Sin acabado de color, la referencia es tal cual (CB04.OP)

Reference order | CBXX.XX

Select finishes



ALBERTA INSIDE

REF 10243.PN | 10243.SR

SUSPENSION OPTIONS (.PN)

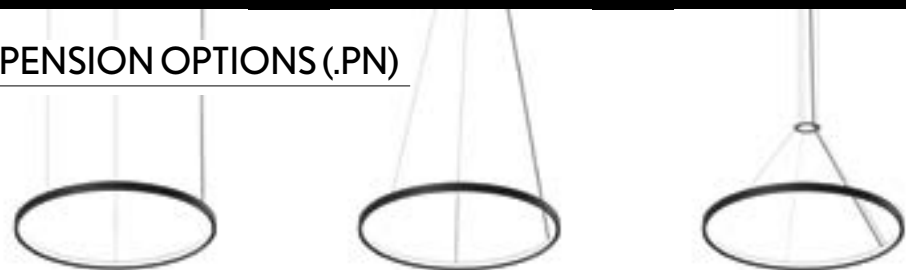

DEFAULT

CABLE CONCENTRATOR

CABLE CONCENTRATOR KIT

PHOTOMETRY



SILICONE

INCLUDED

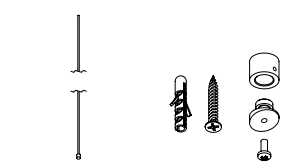

(PN) SC03.SA
WIRE 3M.

(SR) INSTALLATION KIT

PROFILE

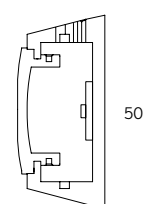

23

new



FINISHES

● COLORS



DIMENSIONS

● DIAMETERS mm. | HEIGHT 50 mm.

350 | 450 | 650 | 950 | 1250

LIGHTING OPTIONS

■ DIFFUSERS

SILICONE

POWERS

STANDARD

CRI

90

COLOR TEMPERATURES

2700K | 3000K | 4000K

▼ DIMMABLE OPTIONS

DALI | 1.10 | PUSH

▲ LIGHT DISTRIBUTION OPTIONS

INSIDE

LUMINAIRE INCLUDES

2 x Suspension cables 3m
DIM or NON-DIM: 1 x Feed Hose 3 x 0,75mm²



ON DEMAND
Special RAL Color
Number of switches
Tunable White
RGB



.PN
PENDANT

INSTALLATIONS

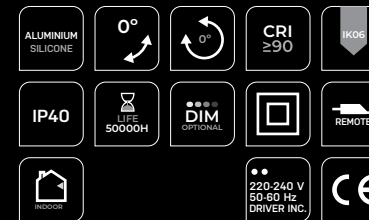

ALBERTA INSIDE VERTICAL

REF. 310008.PN

.PN
PENDANT

310008 ALBERTA INSIDE VERTICAL | PN
Pag. 102



ALBERTA INSIDE VERTICAL	REF.	DIMENSION	FINISH	DIFFUSER OPTIONS	POWER	CRI	K	LUMEN	WATT	Vdc	DIMM OP.	SKETCH
	310008	.35	●	.SI	.ST	.9	.27	3407	32	24	.DA .PU .D1	
							.30	3517				
							.40	3627				
	310008	.45	●	.SI	.ST	.9	.27	4371	41	24	.DA .PU .D1	
							.30	4512				
							.40	4653				
	310008	.65	●	.SI	.ST	.9	.27	6324	59	24	.DA .PU .D1	
							.30	6528				
							.40	6732				
	310008	.95	●	.SI	.ST	.9	.27	9238	86	24	.DA .PU .D1	
							.30	9536				
							.40	9834				
	310008	.125	●	.SI	.ST	.9	.27	12152	113	24	.DA .PU .D1	
							.30	12544				
							.40	12936				

Reference order | 310008.XX.PN.XX.SI.ST9.XX.XX



BOXES (.PN) Not-included, please select:

CONNECTION BOX AND DRIVER BOX FOR REMOTE DRIVER		DRIVER BOX NON-DIMM		DRIVER BOX DIMMABLE		FINISH
						●
CB03	CB04.OP*	CB08.30	CB06.32	CB08.38	CB06.40	

*No finish color, use this reference as it is (CB04.OP).
Sin acabado de color, la referencia es tal cual (CB04.OP)

Reference order | CBXX.XX

• Select finishes

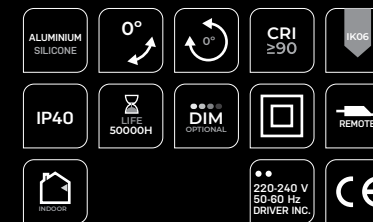

ALBERTA INSIDE VERTICAL

REF. 310008.PN

PHOTOMETRY

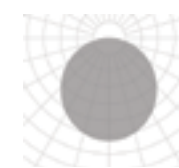

SILICONE

INCLUDED



SC03.SA
WIRE 3M.

PROFILE

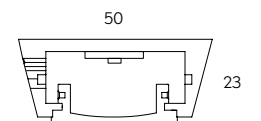

PENDANT
PN

new



FINISHES

● COLORS



DIMENSIONS

● DIAMETERS mm. | HEIGHT 50 mm.

350 | 450

LIGHTING OPTIONS

■ DIFFUSERS

SILICONE

POWERS

STANDARD

CRI

90

COLOR TEMPERATURES

2700K | 3000K | 4000K

▼ DIMMABLE OPTIONS

DALI | 1.10 | PUSH

▲ LIGHT DISTRIBUTION OPTIONS

SIDE

LUMINAIRE INCLUDES

Movable component for fastening to the ceiling.
CENTRAL ROD SC20.60.XX



ON DEMAND
Special RAL Color
Number of switches
Tunable White
RGB



.PN
PENDANT

INSTALLATIONS



ALBERTA INSIDE VTILT

REF. 310009.PN

.PN
PENDANT

310009 ALBERTA INSIDE VTILT
Pag. 106

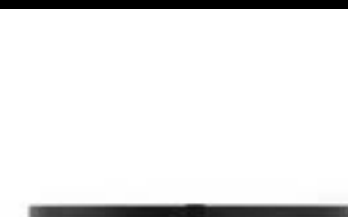

ALBERTA INSIDE VTILT	REF.	DIMENSION	FINISH	DIFFUSER OPTIONS	POWER	CRI	K	LUMEN	WATT	VcC	DIMM*	SKETCH
	310009	.35	●	.SI	.ST	.9	.27	3407	32	24	.DA .PU .D1	
							.30	3517				
							.40	3627				
	310009	.45	●	.SI	.ST	.9	.27	4371	41	24	.DA .PU .D1	
							.30	4512				
							.40	4653				

Reference order | 310009.XX.PN.XX.SI.ST9.XX.XX

SUSPENSION ROD	REF.	DIMENSIONS	FINISH
	SC20	.80 800mm	●
		.100 1000mm	

Reference order | SC20.XX.XX



PENDANT

Select finishes



.WH-WH .BK-BK .GC-GC .BM-BM .BS-BS .BC-BC .CR-CR .CB-CB .GY-GY .MG-MG .VC-VC .YM-YM

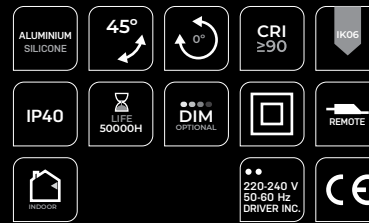

ALBERTA INSIDE VTILT

REF. 310009.PN

PHOTOMETRY

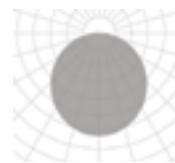

SILICONE

INCLUDED

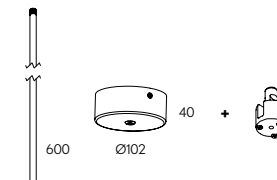

SUSPENSION ROD SC20.60

PROFILE

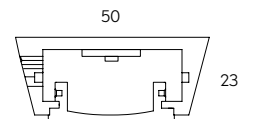



new

FINISHES

● COLORS



DIMENSIONS

● DIAMETERS mm. | HEIGHT 30 mm.

250 | 350 | 450 | 650 | 950 | 1250

LIGHTING OPTIONS

■ DIFFUSERS

SILICONE

POWERS

STANDARD

CRI

90

COLOR TEMPERATURES

2700K | 3000K | 4000K

▼ DIMMABLE OPTIONS

DALI | 1.10 | PUSH

▲ LIGHT DISTRIBUTION OPTIONS

INSIDE - OUTSIDE

LUMINAIRE INCLUDES

3 x Suspension cables 3m
DIM or NON-DIM: 1 x Feed Hose 3 x 0,75mm²

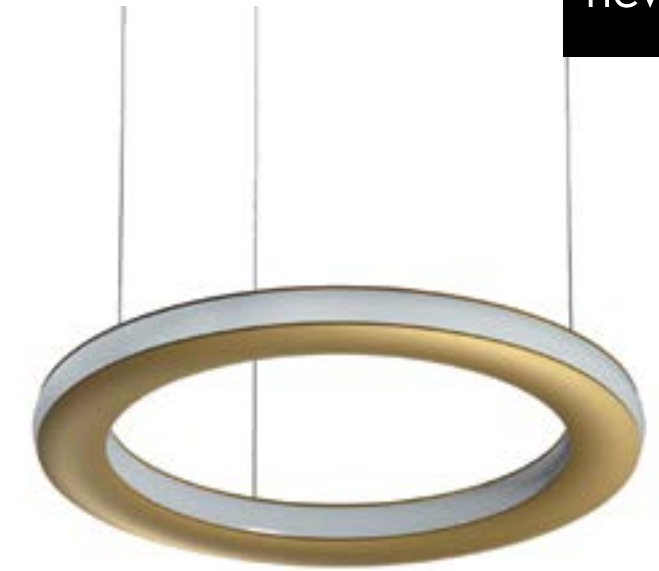

ON DEMAND

Special RAL Color
Number of switches
Tunable White
RGB



.PN

PENDANT

INSTALLATIONS

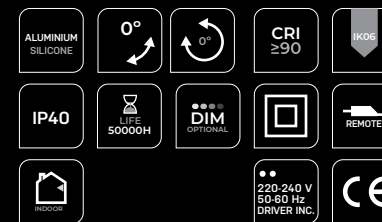

ALBERTA DUE

REF 10250.PN

.PN
PENDANT

10250 ALBERTA DUE | PN
Pag. 110



ALBERTA DUE	REF.	DIMENSION	FINISH	DIFFUSER	POWER	CRI	K	LUMEN MAX.	WATT	Vdc	DIMM OP.	SKETCH
	10250	.25	●	.SI	.ST	.9	.27	2638	24	24V	.DA .PU .D1	
							.30	2638				
							.40	2640				
	10250	.35	●	.SI	.ST	.9	.27	3694	33	24V	.DA .PU .D1	
							.30	3696				
							.40	3700				
	10250	.45	●	.SI	.ST	.9	.27	4750	42	24V	.DA .PU .D1	
							.30	4752				
							.40	4754				
	10250	.65	●	.SI	.ST	.9	.27	6862	61	24V	.DA .PU .D1	
							.30	6866				
							.40	6870				
	10250	.95	●	.SI	.ST	.9	.27	10024	90	24V	.DA .PU .D1	
							.30	10030				
							.40	10036				
	10250	.125	●	.SI	.ST	.9	.27	13188	118	24V	.DA .PU .D1	
							.30	13196				
							.40	13204				

Reference order | 10250.XX.PN.XX.SI.ST9.XX.XX

• Select finishes



OPTIONS

CABLE CONCENTRATOR	CONNECTION BOX	REF.	FOR MODEL	FINISH
		CB10	.25 .35	●

Reference order | CBXX.XX

CABLE CONCENTRATOR KIT	CONNECTION BOX	REF.	FOR MODEL	FINISH
		SC21	.25 .35	●

Reference order | SCXX.XX

SUSPENSION KIT	REF.	DIMENSION	FINISH
	SC05	5M.	.SA
	SC07	7M.	
	SC10	10M.	

Reference order | SCXX.SA

BOXES (.PN) Not-included, please select:

CONNECTION BOX AND DRIVER BOX FOR REMOTE DRIVER		DRIVER BOX NON-DIMM		DRIVER BOX DIMMABLE		FINISH
						●
CB03	CB04.OP*	CB08.30	CB06.32	CB08.38	CB06.40	

*No finish color, use this reference as it is (CB04.OP).
Sin acabado de color, la referencia es tal cual (CB04.OP)

Reference order | CBXX.XX

ALBERTA DUE

REF 10250.PN

SUSPENSION OPTIONS



DEFAULT



CABLE CONCENTRATOR



CABLE CONCENTRATOR KIT

PHOTOMETRY



SILICONE

INCLUDED

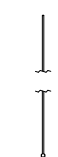

SC03.SA
WIRE 3M.

PROFILE

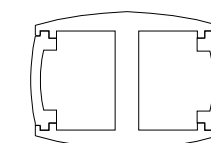

50

PENDANT

new



FINISHES

● COLORS



DIMENSIONS

● DIAMETERS mm. | HEIGHT 30 mm

350 | 450

LIGHTING OPTIONS

■ DIFFUSERS

SILICONE

POWERS

STANDARD

CRI

90

COLOR TEMPERATURES

2700K | 3000K | 4000K

▼ DIMMABLE OPTIONS

DALI | 1.10 | PUSH

▲ LIGHT DISTRIBUTION OPTIONS

INSIDE - OUTSIDE

LUMINAIRE INCLUDES

Connection box with luminaire's finish



ON DEMAND
Special RAL Color
Number of switches
Tunable White
RGB



PENDANT

INSTALLATIONS

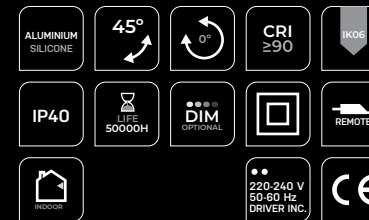

ALBERTA DUE MOVE

REF 310004.PN

.PN PENDANT

310004 ALBERTA DUE MOVE | PN
Pag. 114



ALBERTA DUE MOVE	REF.	DIMENSION	FINISH	DIFFUSER	POWER	CRI	K	LUMEN MAX.	WATT	Vdc	DIMM OP.	SKETCH
	310004	.35	●	.SI	.ST	.9	.27	3694	33	24	.DA .PU .D1	
							.30	3696				
							.40	3700				

	310004	.45	●	.SI	.ST	.9	.27	4750	42	24	.DA .PU .D1	
							.30	4752				
							.40	4754				

Reference order | 310004.XX.PN.XX.XX.ST9.XX.XX



• Select finishes



.WH-WH .BK-BK .GC-GC .BM-BM .BS-BS .BC-BC .CR-CR .CB-CB .GY-GY .MG-MG .VC-VC .YM-YM

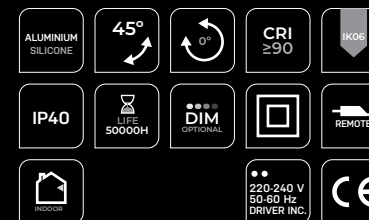

ALBERTA DUE MOVE

REF 310004.PN

PHOTOMETRY

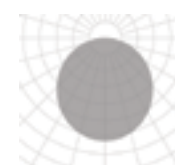

SILICONE

INCLUDED

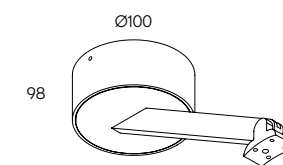

PLATEN

PROFILE

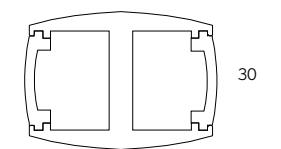

50

.PN

PENDANT

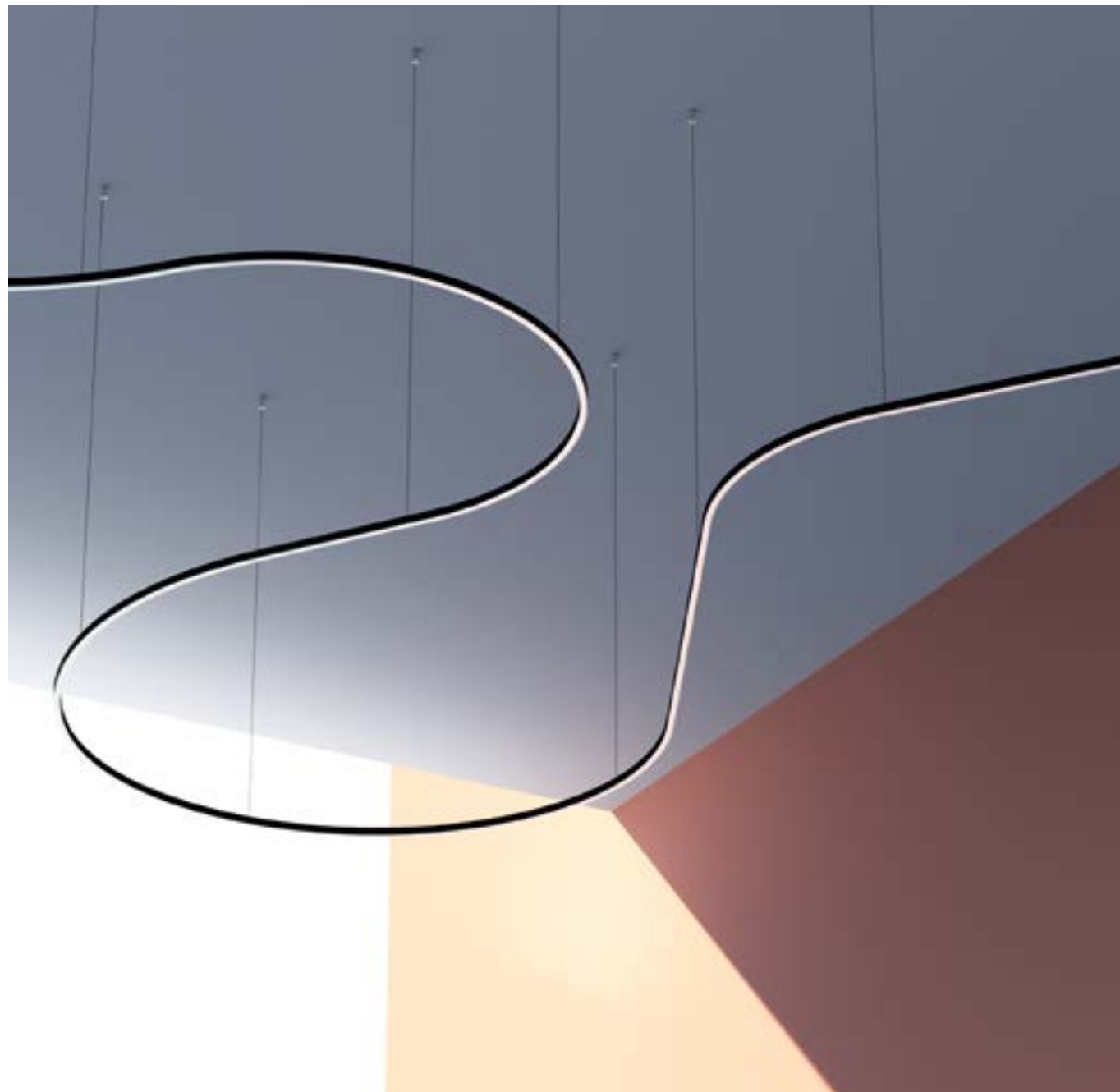

FINISHES

● COLORS



DIMENSIONS

● DIAMETERS mm. | HEIGHT 38 mm.

350 | 450 | 650 | 950 | 1250 | 1500

2000 | 2500 | 3000 | 3500 | 4000 | 5000 | 6000

LIGHTING OPTIONS

■ DIFFUSERS

SILICONE

POWERS

HIGH

CRI

90

COLOR TEMPERATURES

2700K | 3000K | 4000K

▼ DIMMABLE OPTIONS

DALI | 1.10 | PUSH

▲ LIGHT DISTRIBUTION OPTIONS

DOWN | UP-DOWN

LUMINAIRE INCLUDES

.PN

For feed hoses and suspension details refer to mapping table in page 123

.SR

Surface mounting kit



ON DEMAND

Bespoke creations
Special RAL Color
Number of switches
Emergency Lighting*
Motion Detection
Tunable White
RGB
Wireless Control Options (Casambi)

* Delivered separately
(not installed in luminaire).

INSTALLATIONS



.PN
PENDANT

·10217 ALBERTA SOFT | PN
Pag. 118

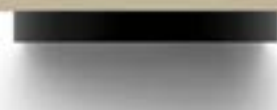

.SR
SURFACE

·10217 ALBERTA SOFT | SR
Pag. 118

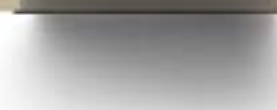

.RF
RECESSED FRAME

·10217 ALBERTA SOFT | RF
Pag. 416



ALBERTA SOFT

REF 10217.PN | 10217.SR

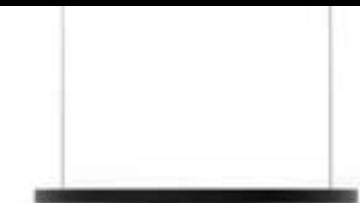









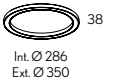



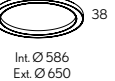

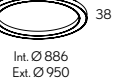









PENDANT | SURFACE

.SR

.PN

PENDANT | SURFACE

ALBERTA SOFT	REF.	DIMENSION	FINISH	DIFFUSER	POWER	CRI	K	DOWNLIGHT			UPLIGHT ▲UP *1		DIMM ▼	SKETCH	
								LUMEN	WATT	mA	LUMEN	WATT			
	10217	.35	●	.SI	.HI	.9	.27	5280	56	700	908	12	.DA .PU .D1	 Int. Ø 286 Ext. Ø 350	
								.30			5316				950
								.40			5844				1020
	10217	.45	●	.SI	.HI	.9	.27	7086	70	700	1287	17	.DA .PU .D1	 Int. Ø 386 Ext. Ø 450	
								.30			7121				1346
								.40			7747				1445
	10217	.65	●	.SI	.HI	.9	.27	8785	86	700	1816	24	.DA .PU .D1	 Int. Ø 586 Ext. Ø 650	
								.30			9040				1900
								.40			9687				2040
	10217	.95	●	.SI	.HI	.9	.27	13298	129	700	2724	36	.DA .PU .D1	 Int. Ø 886 Ext. Ø 950	
								.30			13519				2850
								.40			14703				3060
	10217	.125	●	.SI	.HI	.9	.27	17816	172	700	3556	47	.DA .PU .D1	 Int. Ø 1186 Ext. Ø 1250	
								.30			18135				3721
								.40			18118				3995
	10217	.150	●	.SI	.HI	.9	.27	-	185	500	5701	70	.DA .PU .D1	 Int. Ø 1436 Ext. Ø 1500	
								.30			25440				6054
								.40			26400				6406
	10217	.200	●	.SI	.HI	.9	.27	-	253	500	7642	94	.DA .PU .D1	 Int. Ø 1936 Ext. Ø 2000	
								.30			34185				8115
								.40			35475				8587

ALBERTA SOFT	REF.	DIMENSION	FINISH	DIFFUSER	POWER	CRI	K	DOWNLIGHT			UPLIGHT ▲UP *1		DIMM ▼	SKETCH	
								LUMEN	WATT	mA	LUMEN	WATT			
	10217	.250	●	.SI	.HI	.9	.27	-	318	500	9462	117	.DA .PU .D1	 Int. Ø 2436 Ext. Ø 2500	
								.30			42930				10146
								.40			44550				10362
	10217	.300	●	.SI	.HI	.9	.27	-	383	500	11524	142	.DA .PU .D1	 Int. Ø 2936 Ext. Ø 3000	
								.30			51675				12236
								.40			53625				12949
	10217	.350	●	.SI	.HI	.9	.27	-	433	700	13343	165	.DA .PU .D1	 Int. Ø 3436 Ext. Ø 3500	
								.30			59875				14168
								.40			62843				14993
	10217	.400	●	.SI	.HI	.9	.27	-	513	500	15284	189	.DA .PU .D1	 Int. Ø 3936 Ext. Ø 4000	
								.30			69165				16229
								.40			71775				17174
	10217	.500	●	.SI	.HI	.9	.27	-	643	500	19044	235	.DA .PU .D1	 Int. Ø 4936 Ext. Ø 5000	
								.30			86655				20222
								.40			89925				21400
	10217	.600	●	.SI	.HI	.9	.27	-	772	500	23047	285	.DA .PU .D1	 Int. Ø 5936 Ext. Ø 6000	
								.30			104145				24472
								.40			108075				25897

Reference order | 10217.XX.SR | .XX.XX.HI9.XX.XX.XX

*1 Uplight (UP) is only available for ON-OFF and DALI dimmable (.DA) options, both in 24VdC. - UP luminaires carry the same color temperature above and below (up-down).
La luz indirecta está solo disponible para versiones on-off y regulación DALI (.DA), ambas en 24VdC. - Las luminarias UP llevan la misma temperatura de color arriba y abajo (arriba-abajo).

• Select finishes



ALBERTA SOFT

REF 10217.PN | 10217.SR

SUSPENSION OPTIONS (.PN)

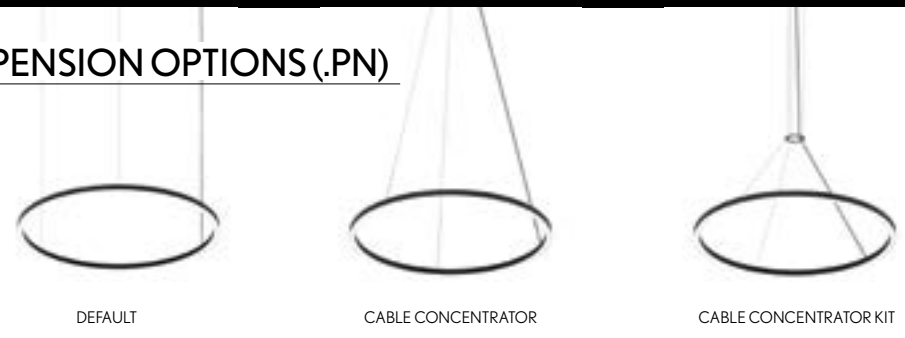

PHOTOMETRY



INCLUDED (.PN)

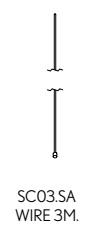

PROFILE

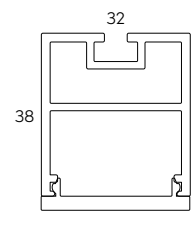

OPTIONS (.PN) Only for .35 .45 .65 .95 .125 .150 models

CABLE CONCENTRATOR	CONNECTION BOX	REF.	FOR MODEL	FINISH
	40 Ø102	CB10	.35	●
	26 Ø150	CB02	.45 .65	
	47 Ø310	CB05	.95 .125 .150	

Reference order | **CBXX.XX**

CABLE CONCENTRATOR KIT	CONNECTION BOX	REF.	FOR MODEL	FINISH
	Ø85 + CB10	SC21	.35	●
	Ø125 + CB02	SC22	.45 .65	
	Ø215 + CB05	SC23	.95 .125 .150	

Reference order | **SCXX.XX**

All models

SUSPENSION KIT	REF.	DIMENSION	FINISH
	SC05	5M.	.SA
	SC07	7M.	
	SC10	10M.	

Reference order | **SCXX.SA**

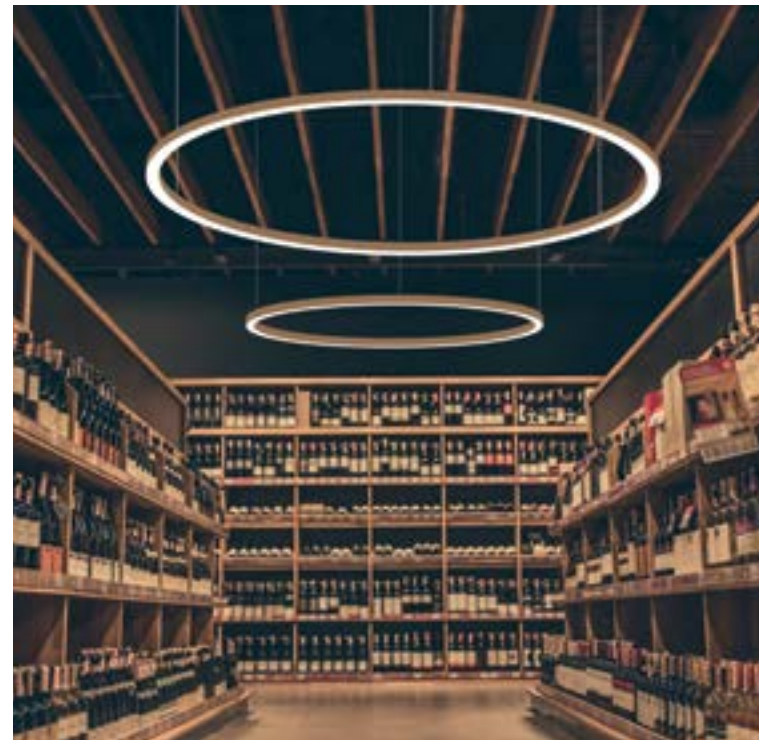

BOXES (.PN) Not-included, please select:

CONNECTION BOX AND DRIVER BOX FOR REMOTE DRIVER		DRIVER BOX NON-DIMM		DRIVER BOX DIMMABLE		FINISH
40 Ø102	40 418	30 45 320	300 Ø66	30 45 400	380 Ø66	●
CB03	CB04.OP*	CB09.32	CB08.30	CB09.40	CB08.38	

*No finish color, use this reference as it is (CB04.OP).
Sin acabado de color, la referencia es tal cual (CB04.OP)

Reference order | **CB09.XX.XX**

LUMINAIRE INCLUDES (.PN)

LUMINAIRE'S DIMENSION	FEED HOSES		SUSPENSIONS
	DOWN	DOWN + UP	
.35	1 Feed Hose 3 x 0,75mm ²	1 Feed Hose 5 x 0,75mm ²	3
.45	1 Feed Hose 3 x 0,75mm ²	1 Feed Hose 5 x 0,75mm ²	3
.65	1 Feed Hose 3 x 0,75mm ²	1 Feed Hose 5 x 0,75mm ²	3
.95	1 Feed Hose 3 x 0,75mm ²	1 Feed Hose 5 x 0,75mm ²	3
.125	1 Feed Hose 5 x 0,75mm ²	1 Feed Hose 5 x 0,75mm ² 1 Feed Hose 3 x 0,75mm ²	3
.150	1 Feed Hose 5 x 0,75mm ²	1 Feed Hose 5 x 0,75mm ² 1 Feed Hose 3 x 0,75mm ²	3
.200	2 Feed Hose 3 x 0,75mm ²	2 Feed Hose 5 x 0,75mm ²	6
.250	3 Feed Hose 3 x 0,75mm ²	3 Feed Hose 5 x 0,75mm ²	9
.300	4 Feed Hose 3 x 0,75mm ²	4 Feed Hose 5 x 0,75mm ²	12
.350	4 Feed Hose 3 x 0,75mm ²	4 Feed Hose 5 x 0,75mm ²	12
.400	5 Feed Hose 3 x 0,75mm ²	5 Feed Hose 5 x 0,75mm ²	15
.500	7 Feed Hose 3 x 0,75mm ²	7 Feed Hose 5 x 0,75mm ²	21
.600	8 Feed Hose 3 x 0,75mm ²	8 Feed Hose 5 x 0,75mm ²	24

• Select finishes

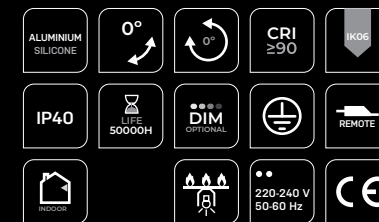

**ALBERTA
SOFT**

REF 10217.PN | 10217.SR

PENDANT | SURFACE

.SR

.PN

PENDANT | SURFACE



FINISHES

● COLORS



DIMENSIONS

DIAMETERS mm.	HEIGHT	80 mm.
450 650 950 1250 1500 2000		
2500 3000 4000 5000 6000		

LIGHTING OPTIONS

■ DIFFUSERS

OPAL | MICROPRISMATIC

POWERS

STANDARD

CRI

90

COLOR TEMPERATURES

2700K | 3000K | 4000K

▼ DIMMABLE OPTIONS

DALI | 1.10 | PUSH

▲ LIGHT DISTRIBUTION OPTIONS

DOWN | UP-DOWN

LUMINAIRE INCLUDES

.PN

3 x Suspension cables 3m
 NON-DIM DOWN: 1 x Feed Hose 3 x 0,75mm²
 DIM DOWN or NON-DIM DOWN-UP: 1 x Feed Hose 5 x 0,75mm²
 DIM DOWN-UP (only): 1 x Feed Hose 5 x 0,75mm²
 Connection box CB03 with luminaire's finish

.SR

Surface mounting kit



ON DEMAND

Special RAL Color
 Special Color Temperature
 Number of switches
 Emergency Lighting*
 Motion Detection
 Wireless Control Options (Casambi)
 Other Dimensions

* Delivered separately
 (not installed in luminaire).

INSTALLATIONS



ALBERTA SLIGHT

REF 10193.PN | 10193.SR

.PN
PENDANT







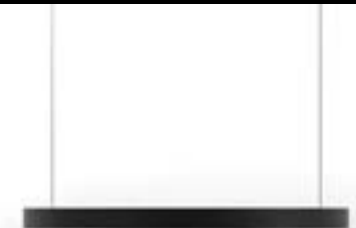



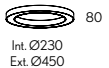

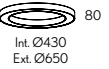



10193 ALBERTA SLIGHT | PN
Pag. 124

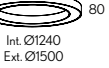

.SR
SURFACE

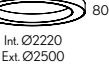
10193 ALBERTA SLIGHT | SR
Pag. 124

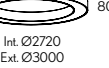



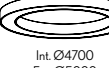

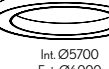

.SR
.PN
PENDANT | SURFACE

ALBERTA SLIGHT	REF.	DIMENSION	FINISH	DIFFUSER	POWER	CRI	K	DOWNLIGHT			UPLIGHT ▲UP *1		DIMM ▼	SKETCH
								LUMEN	WATT	mA	LUMEN	WATT		
	10193	.45	●	.OP .MP	.ST	.9	.27 .30 .40	3157	32	700	1287	.DA .PU .D1		
								3430			1346			
								3500			1445			
	10193	.65	●	.OP .MP	.ST	.9	.27 .30 .40	4510	45	700	1816	.DA .PU .D1		
								4900			1900			
								5000			2040			
	10193	.95	●	.OP .MP	.ST	.9	.27 .30 .40	7216	73	700	2724	.DA .PU .D1		
								7840			2850			
								8000			3060			
	10193	.125	●	.OP .MP	.ST	.9	.27 .30 .40	10824	109	700	3556	.DA .PU .D1		
								11760			3721			
								12000			3995			
	10193	.150	●	.OP .MP	.ST	.9	.27 .30 .40	13530	136	700	4174	.DA .PU .D1		
								14700			4300			
								15000			4554			
	10193	.200	●	.OP .MP	.ST	.9	.27 .30 .40	18942	189	700	5595	.DA .PU .D1		
								20580			5765			
								21000			6105			
	10193	.250	●	.OP .MP	.ST	.9	.27 .30 .40	23001	230	700	6927	.DA .PU .D1		
								24990			7137			
								25500			7559			
	10193	.300	●	.OP .MP	.ST	.9	.27 .30 .40	28864	288	700	8436	.DA .PU .D1		
								31360			8693			
								32000			9206			
	10193	.400	●	.OP .MP	.ST	.9	.27 .30 .40	37884	378	700	9768	.DA .PU .D1		
								41160			10065			
								42000			10659			

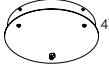
ALBERTA SLIGHT	REF.	DIMENSION	FINISH	DIFFUSER	POWER	CRI	K	DOWNLIGHT			UPLIGHT ▲UP *1		DIMM ▼	SKETCH
								LUMEN	WATT	mA	LUMEN	WATT		
	10193	.500	●	.OP .MP	.ST	.9	.27 .30 .40	43296	432	700	7324	.DA .PU .D1		
								47040			7589			
								48000			9645			
	10193	.600	●	.OP .MP	.ST	.9	.27 .30 .40	54120	540	700	8800	.DA .PU .D1		
								58800			9119			
								60000			11590			

OPTIONS (.PN) Only for .35 .45 .65 .95 .125 .150 models

CABLE CONCENTRATOR	CONNECTION BOX	REF.	FOR MODEL	FINISH
		CB02	.45 .65	●
		CB05	.95 .125	

CABLE CONCENTRATOR KIT	CONNECTION BOX	REF.	FOR MODEL	FINISH
		SC22	.45 .65	●
		SC23	.95 .125	

All models Reference order CBXX.XX

Reference order SCXX.XX

SUSPENSION KIT	REF.	DIMENSION	FINISH
	SC05	5M.	.SA
	SC07	7M.	
	SC10	10M.	

Reference order SCXX.SA

- ALUMINUM PC
- 0°
- 0°
- CRI ≥90
- IP40
- LIFE 50000H
- DIM OPTIONAL
- INTEGRATED
- RECORD
- 220-240 V 50-60 Hz
- CE

ALBERTA SLIGHT

REF 10193.PN | 10193.SR

● Select finishes



Reference order 10193.XX.SR.PN.XX.XX.ST9.XX.XX.XX

PHOTOMETRY

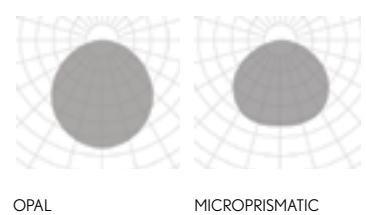

INCLUDED (.PN)

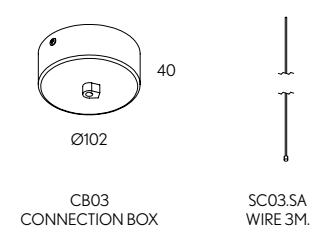

PROFILE

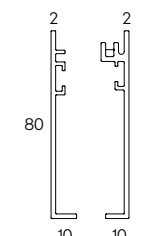

*1 Uplight (UP) is only available for ON-OFF and DALI dimmable (.DA) options, both in 24VdC. - U.P luminaires carry the same color temperature above and below (up-down).
La luz indirecta está solo disponible para versiones on-off y regulación DALI (.DA), ambas en 24VdC. - Las luminarias .UP llevan la misma temperatura de color arriba y abajo (arriba-abajo).



FINISHES

● COLORS



DIMENSIONS

● DIAMETERS mm. | HEIGHT 80 mm.

650 | 950 | 1250

LIGHTING OPTIONS

■ DIFFUSERS

OPAL | MICROPRISMATIC

POWERS

STANDARD

CRI

90

COLOR TEMPERATURES

2700K | 3000K | 4000K

▼ DIMMABLE OPTIONS

DALI | 1.10 | PUSH

▲ LIGHT DISTRIBUTION OPTIONS

DOWN | UP-DOWN

LUMINAIRE INCLUDES

.PN

3 x Suspension cables 3m
 NON-DIM DOWN: 1 x Feed Hose 3 x 0,75mm²
 DIM DOWN or NON-DIM DOWN-UP: 1 x Feed Hose 5 x 0,75mm²
 DIM DOWN-UP (only): 1 x Feed Hose 5 x 0,75mm²
 Connection box CBO3 with luminaire's finish

.SR

Surface mounting kit



ON DEMAND

Special RAL Color
 Special Color Temperature
 Number of switches
 Emergency Lighting*
 Motion Detection
 Wireless Control Options (Casambi)

* Delivered separately
 (not installed in luminaire).

INSTALLATIONS



ALBERTA SLIGHT ECCENTRIC

REF 310005.PN | 310005.SR

.PN
PENDANT

·310005 ALBERTA SLIGHT
ECCENTRIC | PN - Pag. 128

.SR
SURFACE

·310005 ALBERTA SLIGHT
ECCENTRIC | SR - Pag. 128

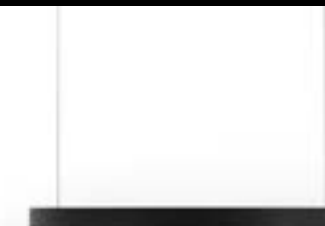

PENDANT | SURFACE

ALBERTA SLIGHT ECCENTRIC	REF.	DIMENSION	FINISH	DIFFUSER	POWER	CRI	K	DOWNLIGHT			UPLIGHT ▲UP *1		DIMM ▼	SKETCH
								LUMEN	WATT	mA	LUMEN	WATT		
	310005	.65	●	.OP .MP	.ST	.9	.27	10373	104	700	1816	24	.DA .PU .D1	
								11270			1900			
								11500			2040			
	310005	.95	●	.OP .MP	.ST	.9	.27	19393	195	700	2724	36	.DA .PU .D1	
								21070			2850			
								21500			3060			
	310005	.125	●	.OP .MP	.ST	.9	.27	28864	291	700	3556	47	.DA .PU .D1	
								31360			3721			
								32000			3995			

Reference order | 310005.XX | .SR | .PN | .XX.XX | .ST9.XX.XX.XX

OPTIONS (.PN)

CABLE CONCENTRATOR	CONNECTION BOX	REF.	FOR MODEL	FINISH	CABLE CONCENTRATOR KIT	CONNECTION BOX	REF.	FOR MODEL	FINISH
		CB02	.65	●			SC22	.65	●
		CB05	.95 .125				SC23	.95 .125	

Reference order | CBXX.XX

Reference order | SCXX.XX

SUSPENSION KIT	REF.	DIMENSION	FINISH	
	SC05	5M.	●	
	SC07	7M.		.SA
	SC10	10M.		

Reference order | SCXX.XX

*1 Uplight (UP) is only available for ON-OFF and DALI dimmable (.DA) options, both in 24VdC. - U.P luminaires carry the same color temperature above and below (up-down).
La luz indirecta está solo disponible para versiones on-off y regulación DALI (.DA), ambas en 24VdC. - Las luminarias .UP llevan la misma temperatura de color arriba y abajo (arriba-abajo).

• Select finishes



- ALUMINUM PC
- 0°
- 0°
- CRI ≥ 90
- IK05
- IP40
- LIFE 50000H
- DIM OPTIONAL
- INTEGRATED
- RECYCLED
- 220-240 V 50-60 Hz
- CE

ALBERTA SLIGHT ECCENTRIC

REF 310005.PN | 310005.SR

SUSPENSION OPTIONS (.PN)

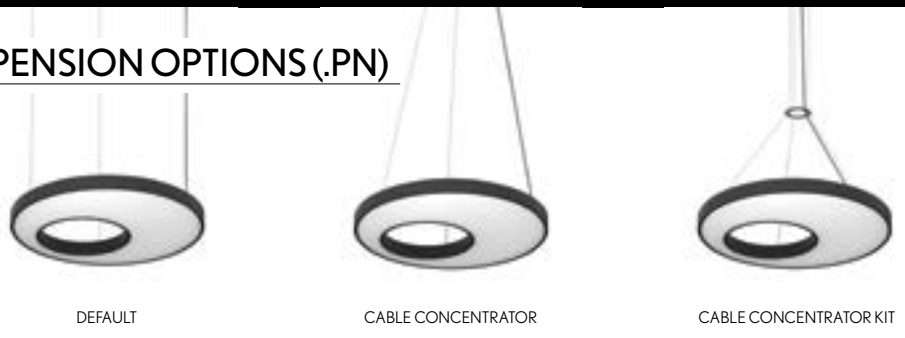

PHOTOMETRY

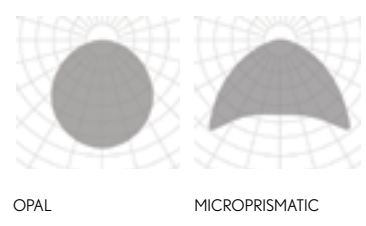

INCLUDED (.PN)

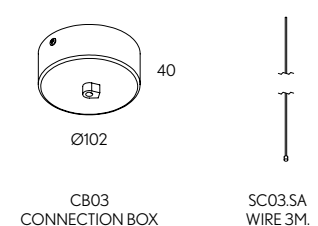

PROFILE

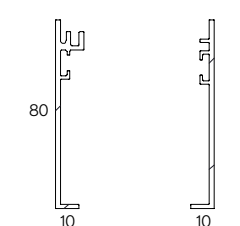



FINISHES

● COLORS



DIMENSIONS

● DIAMETERS mm. | HEIGHT 114 mm.

650 | 950 | 1250

LIGHTING OPTIONS

■ DIFFUSERS

OPAL | MICROPRISMATIC

POWERS

STANDARD | HIGH

CRI

90

COLOR TEMPERATURES

2700K | 3000K | 4000K | TW

▼ DIMMABLE OPTIONS

DALI | 1.10 | PUSH

▲ LIGHT DISTRIBUTION OPTIONS

DOWN | UP-DOWN

LUMINAIRE INCLUDES

.PN

3 x Suspension cables 3m
 NON-DIM DOWN: 1 x Feed Hose 3 x 0,75mm²
 DIM DOWN or NON-DIM DOWN-UP: 1 x Feed Hose 5 x 0,75mm²
 DIM DOWN-UP (only): 1 x Feed Hose 5 x 0,75mm²
 Connection box CB03 with luminaire's finish

.SR

Surface mounting kit



ON DEMAND

Special RAL Color
 Special Color Temperature
 Number of switches
 Emergency Lighting*
 CRI 80
 Motion Detection
 RGB
 Wireless Control Options (Casambi)
 Other Dimensions

* Delivered separately
 (not installed in luminaire).

INSTALLATIONS



ALBERTA

REF 10176.PN

.PN
PENDANT

·10176 ALBERTA | PN
Pag. 132

.RF
RECESSED FRAME

·10176 ALBERTA | RF
Pag. 420

.TR
TRIMLESS

·10176 ALBERTA | TR
Pag. 604

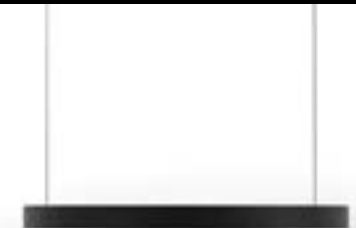
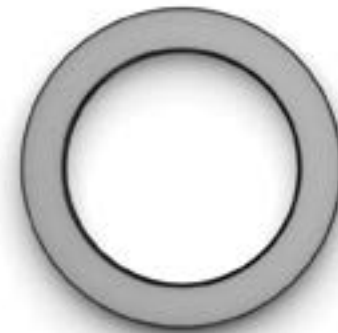

PENDANT

.PN

ALBERTA	REF.	DIMENSION	FINISH	DIFFUSER	POWER	CRI	K	DOWNLIGHT			UPLIGHT ▲ UP *2		DIMM OP. ▼	SKETCH				
								LUMEN	WATT	mA	LUMEN	WATT						
	10176	.65	●	.OP .MP	.ST	.9	.27	3060	24	500	1816	24	.DA .PU .D1					
							.30	3180			1900							
							.40	3300			2040							
							.HI	.9			.27				-	-	24	.DA .PU .D1
											.30				6356	1900		
											.40				6608	2040		
	10176	.95	●	.OP .MP	.ST	.9	.27	6120	47	500	2724	36	.DA .PU .D1					
							.30	6360			2850							
							.40	6600			3060							
							.HI	.9			.27				-	-	36	.DA .PU .D1
											.30				12712	2850		
											.40				13216	3060		
	10176	.125	●	.OP .MP	.ST	.9	.27	9180	71	500	3556	47	.DA .PU .D1					
							.30	9540			3721							
							.40	9900			3995							
							.HI	.9			.27				-	-	47	.DA .PU .D1
											.30				19068	3721		
											.40				19824	3995		

Reference order 10176.XX.PN.XX.XX.XX.XX.XX.XX.XX

• Select finishes



OPTIONS (.PN)

CABLE CONCENTRATOR	CONNECTION BOX	REF.	FOR MODEL	FINISH
		CB02	.65	●
		CB05	.95 .125	

Reference order CBXX.XX

CABLE CONCENTRATOR KIT	CONNECTION BOX	REF.	FOR MODEL	FINISH
		SC22	.65	●
		SC23	.95 .125	

Reference order SCXX.XX

SUSPENSION KIT	REF.	DIMENSION	FINISH
	SC05	5M.	.SA
	SC07	7M.	
	SC10	10M.	

Reference order SCXX.SA

.PN

PENDANT

ALBERTA

REF 10176.PN

PHOTOMETRY

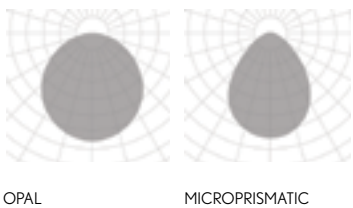

INCLUDED (.PN)

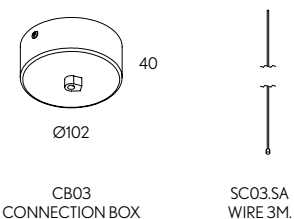

PROFILE

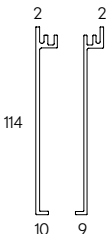

*1 Tunable White (TW) values correspond to 2700K and 6500K - TW is only available for DALI DT8 dimmable (DA), CRI 80 (8) 700mA. Los valores del blanco dinámico (TW) corresponden a 2700K y 6500K. -TW solo está disponible con protocolo DALI DT8 (DA), CRI 80 (8) 700mA.
 *2 Uplight (UP) is only available for ON-OFF and DALI dimmable (DA) options, both in 24VdC. - U.P luminaires carry the same color temperature above and below (up-down).
 La luz indirecta está solo disponible para versiones on-off y regulación DALI (DA), ambas en 24VdC. - Las luminarias U.P llevan la misma temperatura de color arriba y abajo (arriba-abajo).
 *2 Indirect Lighting U.P uplight shares equal lumen output for .ST and .HI versions. La luz indirecta U.P comparte la misma salida de lúmenes para las versiones .ST y .HI.



OKKO

Guaranteed success for your lighting projects.

The answer is always yes. There are no limits. Excellent, customisable designs that enhance any architectural and design project. A tasteful, versatile choice that never disappoints.

OK a todas tus propuestas de iluminación.

Ok a todo. Sin límites. Y con gran capacidad de personalización de los embellecedores, para integrarse en proyectos globales de arquitectura y decoración. Sin duda, una elección segura, versátil y que no defrauda.



new



FINISHES

● COLORS



DIMENSIONS

◆ DIAMETERS mm.

650 | 950 | 1250

LIGHTING OPTIONS

■ BEAM ANGLE

20° | 40° | 60°

POWER

STANDARD

CRI

90

COLOR TEMPERATURE

2700K | 3000K | 4000K

▼ DIMMABLE OPTIONS

CONSULT OPTIONS

▲ LIGHT DISTRIBUTION

DOWN

LUMINAIRE INCLUDES

.PN

3 x Suspension cables 3m
NON-DIM DOWN or DIM DOWN: 1 x Feed Hose 3 x 0,75mm²

.SR

Surface mounting kit



SOON



ON DEMAND

Special RAL Color
Emergency Lighting *
Motion Detection
Wireless Control Options (Casambi)
Dimm Options



REMOTE

* Delivered separately
(not installed in luminaire).

INSTALLATIONS

.PN
PENDANT

10254 OKKO MODULAR | PN
Pag. 138

.SR
SURFACE

10254 OKKO MODULAR | SR
Pag. 138



OKKO MODULAR

REF 10254.PN | 10254.SR



PENDANT | SURFACE

.SR

.PN

PENDANT | SURFACE

OKKO MODULAR	REF.	DIMENSION	FINISH	POSITIONS
	10254	.65	●	10
		.95		15
		.125		20

Reference order | 10254.XX | .SR | .PN | .XX

Configure your OKKO combining LED modules and OPAQUE as you wish.
 Configura tu OKKO combinando los módulos LED y OPAQUES que desees.
 Requires a minimum of equidistantly distributed opaques to access the installation.
 Requiere un mínimo de opaques distribuidos de forma equidistante para acceder a la instalación.

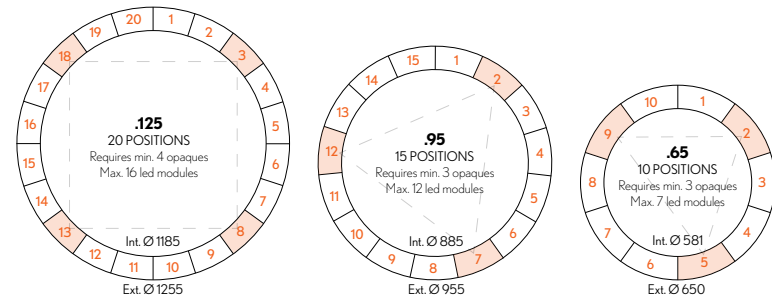

OKKO LED MODULES	REF.	DIMENSION	FINISH	OPTIC OPTIONS	POWER	CRI	.27	LUMEN	.30	.40	WATT	mA	SKETCH
	110003	.65	●	.20 .40 .60	.ST	.9	.27	460	498	570	7	500	
		.95						460	498	570	7	500	
		.125						460	498	570	7	500	

Reference order | 110003.XX.XX.XX.ST9.XX

OKKO OPAQUE	REF.	DIMENSION	FINISH	MIN. OPAQUES
	ACC10254	.65	●	3
		.95		3
		.125		4

Reference order | ACC10254.XX.XX

OKKO DRIVER	DIMENSION *
DR10254	.01 1-3 modules
	.02 4-10 modules
	.03 11-13 modules
	.04 14-16 modules

Reference order | DR10254.XX.XX

Not-included, please select:

STANDARD SUSPENSION	CONNECTION BOX AND BOX FOR REMOTE DRIVER	BOX FOR INTEGRATED NON-DIMM DRIVER	FINISH
			●
	CB03	CB05	

*IP65 remote driver box with no finish color (CB04.OP) for SR installation. When .PN please select both CB03 & CB04.OP.
 Caja IP65 para driver remoto y sin acabado de color (CB04.OP) para instalación SR. Cuando sea .PN, seleccione CB03 y CB04.OP.

Reference order | CBXXXX.XX

SUSPENSION KIT	REF.	DIMENSION	FINISH
	SC05	5M.	.SA
	SC07	7M.	
	SC10	10M.	

Reference order | SCXX.SA

Suspension options:

CABLE CONCENTRATOR	CONNECTION BOX	REF.	Nº MODULES	FINISH
		CB10*	2-16	●
		CB07	2-4	
		CB05	5-16	

*Only for remote driver. Únicamente para driver remoto.

Reference order | CBXX.XX

CABLE CONCENTRATOR KIT	CONNECTION BOX	REF.	Nº MODULES	FINISH
		SC21	2-16	●
		SC22	2-4	
		SC23	5-16	

Reference order | SC2X.XX

REFERENCE ORDER EXAMPLE EJEMPLO DE REFERENCIA

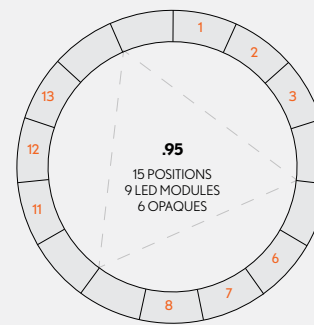

Create an OKKO like the one in the example. Crea un OKKO como el del ejemplo:

- Select PROFILE. Selecciona PERFIL. 10254.95.PN.XX
- Select LED MODULE and quantity. Selecciona el módulo LED y la cantidad. 110003.95.XX.XX.ST9.XX (9 Qty./Uds.)
- Add LED MODULES' position. Añade la posición de los módulos LED. 1, 2, 3, 6, 7, 8, 11, 12, 13
- Add number of OPAQUE diffusers. Añade el número de difusores OPAQUE considerando el mínimo necesario. ACC10254.95.XX (6 Qty./Uds.)
- Verify DRIVER depending on the number of LED modules. Verifica el DRIVER dependiendo del número de módulos LED. DR10254.02.XX

Select finishes



OKKO MODULAR

REF 10254.PN | 10254.SR

Let's create

Give full rein to your imagination. Configure your Okko Modular to suit best your project needs
 ¡Da rienda suelta a tu imaginación! Configura tu Okko Modular según las necesidades de tu proyecto

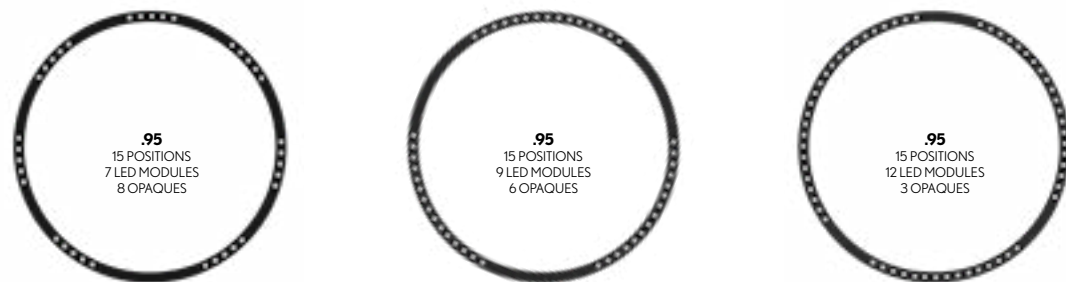

PHOTOMETRY

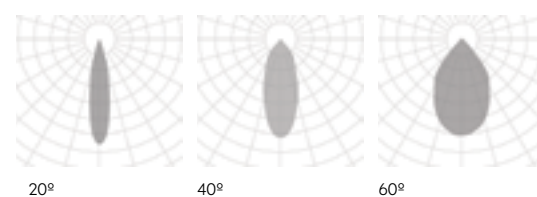

INCLUDED (.PN)

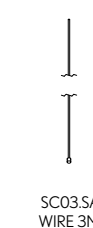

PROFILE

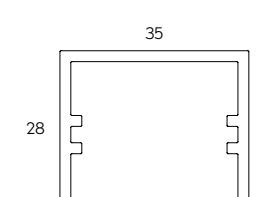

PENDANT | SURFACE

.SR
.PN

PENDANT | SURFACE



FINISHES

● COLORS



DIMENSIONS

◆ DIAMETERS mm.

650 | 950 | 1250

LIGHTING OPTIONS

■ BEAM ANGLE

20° | 40° | 60°

POWER

STANDARD

CRI

90

COLOR TEMPERATURE

2700K | 3000K | 4000K

▼ DIMMABLE OPTIONS

CONSULT OPTIONS

▲ LIGHT DISTRIBUTION

DOWN

LUMINAIRE INCLUDES

.PN

3 x Suspension cables 3m
NON-DIM DOWN or DIM DOWN: 1 x Feed Hose 3 x 0,75mm²

.SR

Surface mounting kit



SOON



ON DEMAND

Special RAL Color
Emergency Lighting*
Motion Detection
Wireless Control Options (Casambi)
Dimm Options



REMOTE

* Delivered separately
(not installed in luminaire).

INSTALLATIONS

.PN
PENDANT

·10252 OKKOPLUSMODULAR|PN
Pag. 142

.SR
SURFACE

·10252 OKKO PLUS MODULAR|SR
Pag. 142



OKKO PLUS MODULAR

REF 10252.PN | 10252.SR

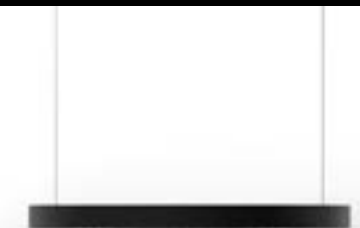

.SR

.PN

PENDANT | SURFACE

OKKO PLUS MODULAR	REF.	DIMENSION	FINISH	POSITIONS
	10252	.65	●	10
		.95		15
		.125		20

Reference order | 10252.XX | .SR | .PN | .XX

Configure your OKKO PLUS combining LED modules and OPAQUE as you wish.
 Configura tu OKKO PLUS combinando los módulos LED y OPAQUES que desees.
 Requires a minimum of equidistantly distributed opaques to access the installation.
 Requiere un mínimo de opaques distribuidos de forma equidistante para acceder a la instalación.

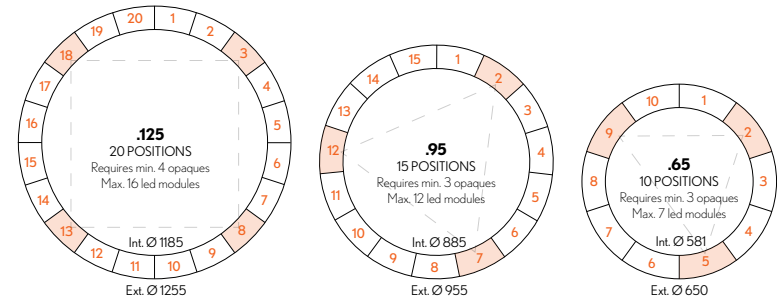

OKKO PLUS LED MODULES	REF.	DIMENSION	FINISH	OPTIC OPTIONS	POWER	CRI	LUMEN	WATT	mA	SKETCH
	110002	.65	●	.20 .40 .60	.ST	.9	.27 .30 .40	7	500	
		.95					460 498 570			
		.125					460 498 570			

Reference order | 110002.XX.XX.XX | .ST9.XX

OKKO PLUS OPAQUE	REF.	DIMENSION	FINISH	MIN. OPAQUES
	ACC10252	.65	●	3
		.95		3
		.125		4

Reference order | ACC10252.XX.XX

OKKO DRIVER	DIMENSION *
DR10252	.01 1-3 modules
	.02 4-10 modules
	.03 11-13 modules
	.04 14-16 modules

Reference order | DR10252.XX.XX

Not-included, please select:

STANDARD SUSPENSION	CONNECTION BOX AND BOX FOR REMOTE DRIVER	BOX FOR INTEGRATED NON-DIMM DRIVER	FINISH
			●

*IP65 remote driver box with no finish color (CB04.OP) for SR installation. When .PN please select both CB03 & CB04.OP.
 Caja IP65 para driver remoto y sin acabado de color (CB04.OP) para instalación SR. Cuando sea .PN, seleccione CB03 y CB04.OP.

Reference order | CBXXXX.XX

SUSPENSION KIT	REF.	DIMENSION	FINISH
	SC05	5M.	.SA
	SC07	7M.	
	SC10	10M.	

Reference order | SCXX.SA

Suspension options:

CABLE CONCENTRATOR	CONNECTION BOX	REF.	Nº MODULES	FINISH
		CB10*	2-16	●
		CB07	2-4	
		CB05	5-16	

*Only for remote driver. Únicamente para driver remoto.

Reference order | CBXX.XX

CABLE CONCENTRATOR KIT	CONNECTION BOX	REF.	Nº MODULES	FINISH
		SC21	2-16	●
		SC22	2-4	
		SC23	5-16	

Reference order | SC2X.XX

REFERENCE ORDER EXAMPLE EJEMPLO DE REFERENCIA

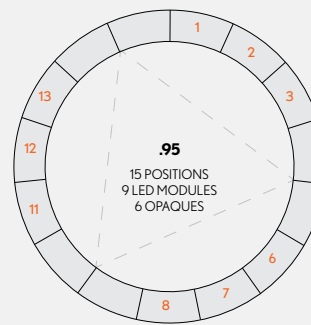

Create an OKKO PLUS like the one in the example. Crea un OKKO PLUS como el del ejemplo:

- Select PROFILE. Selecciona PERFIL. 10252.95.PN.XX
- Select LED MODULE and quantity. Selecciona el módulo LED y la cantidad. 110002.95.XX.XX.ST9.XX (9 Qty./Uds.)
- Add LED MODULES' position. Añade la posición de los módulos LED. 1, 2, 3, 6, 7, 8, 11, 12, 13
- Add number of OPAQUE diffusers. Añade el número de difusores OPAQUE. ACC10252.95.XX (6 Qty./Uds.)
- Verify DRIVER depending on the number of LED modules. Verifica el DRIVER dependiendo del número de módulos LED. DR10252.02.XX

Select finishes



OKKO PLUS MODULAR

REF 10252.PN | 10252.SR

Let's create

Give full rein to your imagination. Configure your OKKO PLUS MODULAR to suit best your project needs
 ¡Da rienda suelta a tu imaginación! Configura tu OKKO PLUS MODULAR según las necesidades de tu proyecto

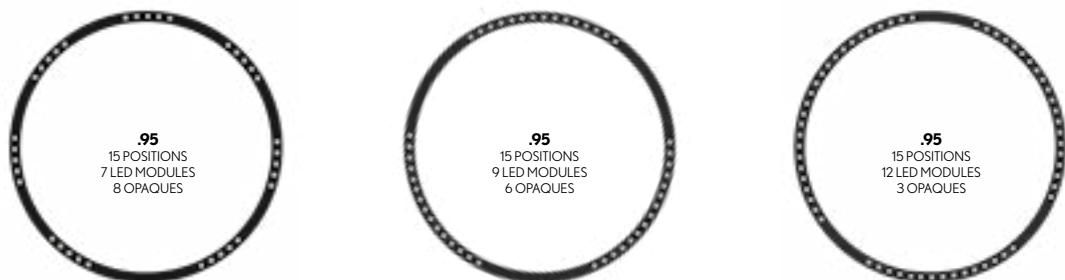

PHOTOMETRY

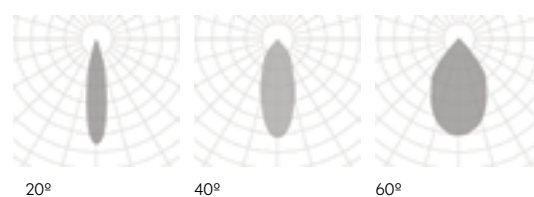

INCLUDED (.PN)

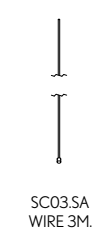

PROFILE

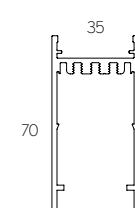

PENDANT | SURFACE

.SR

.PN

PENDANT | SURFACE

A blank canvas.

Imagination, illumination. Limitless light. If that sounds good to you, meet our Line Profiles! Extensive, versatile, with reliable technology and features.

It comes with a wide variety of high quality extruded aluminium profiles with opal, microprismatic or silicone diffusers: Alba, Wing, Alzira, Edge, Linggo, Okkia, Bubble and Bold, for the most daring.

Un lienzo en blanco.

Imaginar, proyectar, iluminar. Sin condicionantes. Si eso es lo que se pretende, nuestros perfiles lineales y curvos son la familia de productos ideal. Por extensa, por versátil, por tecnología y prestaciones.

Se presentan en una amplia gama de perfiles de aluminio extruido de alta calidad y con difusores opal, microprismático o silicona: Alba, Wing, Alzira, Edge, Linggo, Okkia, Bubble y Bold, para los más atrevidos.



LINES

PENDANT | SURFACE

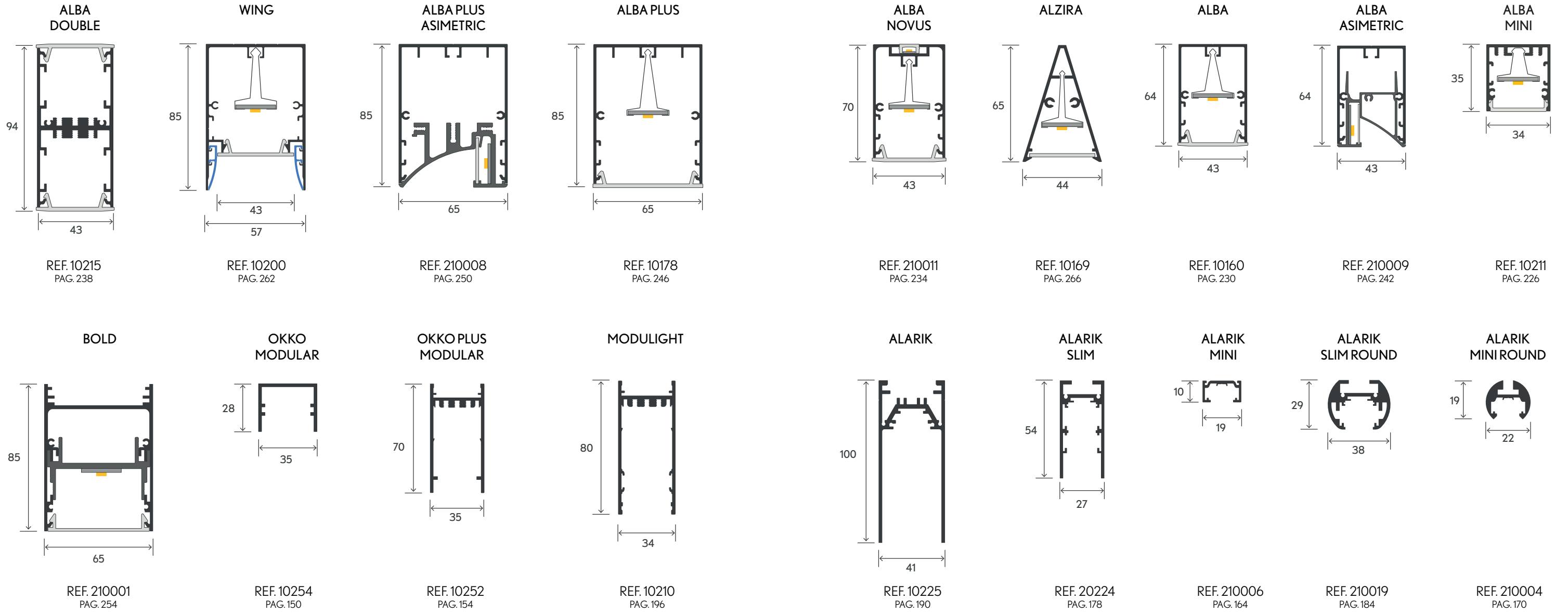

PROFILE OVERVIEW

PENDANT | SURFACE

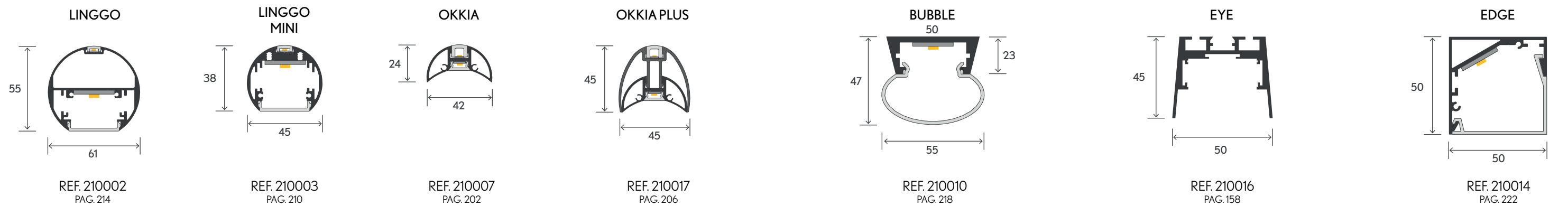



FINISHES

● COLORS



DIMENSIONS

◆ LENGTHS mm.

794 | 1189 | 1584 | 1979

LIGHTING OPTIONS

■ BEAM ANGLE

20° | 40° | 60°

POWER

STANDARD

CRI

90

COLOR TEMPERATURE

2700K | 3000K | 4000K

▼ DIMMABLE OPTIONS

DALI | 1.10 | PUSH

▲ LIGHT DISTRIBUTION

DOWN

LUMINAIRE INCLUDES

.PN

2 x Suspension cables 3m
NON-DIM DOWN or DIM DOWN: 1 x Feed Hose 3 x 0,75mm²

.SR

Surface mounting kit



SOON



ON DEMAND

Special RAL Color
Emergency Lighting *
Custom dimensions
Motion Detection
Wireless Control Options (Casambi)



* Delivered separately
(not installed in luminaire).

INSTALLATIONS



OKKO MODULAR LINE

REF 210012.PN | 210012.SR



.PN
PENDANT

·210012 OKKO MODULAR LINE |
PN - Pag. 150



.SR
SURFACE

·210012 OKKO MODULAR LINE |
SR - Pag. 150

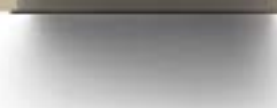

.RF
RECESSED FRAME

·410012 OKKO MODULAR |
RF - Pag. 468

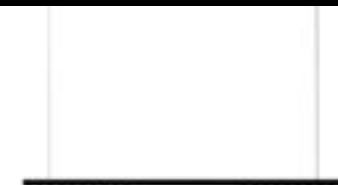
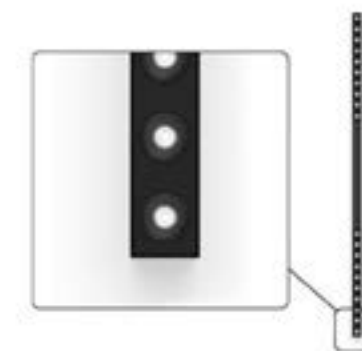

OKKO MODULAR LINE	REF.	DIMENSION	FINISH	POSITIONS
	210012	.02	●	2
		.03		3
		.04		4
		.05		5

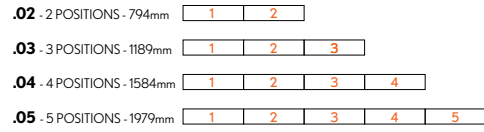

Reference order | 210012.XX.SR.PN.XX

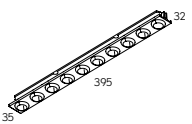
OKKO LINE LED MODULES	REF.	DIMENSION	FINISH	OPTIC OPTIONS	POWER	CRI	LUMEN	WATT	mA	SKETCH
	110004	.10	●	.20 .40 .60	.ST	.9	947 1058 1122	12	500	

Reference order | 110004.10.XX.XX.ST9.XX

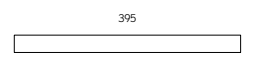
OKKO LINE OPAQUE	REF.	DIMENSION	FINISH	SKETCH
	ACC210012	.10	●	

Reference order | ACC210012.10.XX

OKKO LINE DRIVER	DIMENSION	DIMM
DR210012	.01	1 - 5 modules
	.02	6 - 9 modules
	.03	10 - 13 modules
	.04	14 - 17 modules
	.05	18 - 20 modules

Reference order | DR210012.XX.XX

COVER KIT	REF.	FINISH
	TF24	●

Reference order | TF24.SR.PN.XX

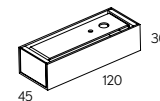
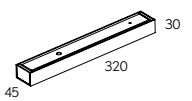
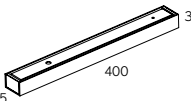
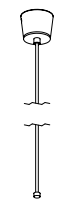

Not-included, please select:

CONNECTION BOX AND DRIVER BOX FOR REMOTE DRIVER	DRIVER BOX NON-DIMM	DRIVER BOX DIMMABLE	FINISH	SUSPENSION KIT	REF.	DIMENSION	FINISH
			●		SC05	5M.	.SA
CB09.12	CB04.OP *	CB09.32	CB09.40	SC07	7M.		
				SC10	10M.		

*No finish color, use this reference as it is (CB04.OP).
Sin acabado de color, la referencia es tal cual (CB04.OP)

Reference order | CBXXXX.XX

Reference order | SCXX.SA

REFERENCE ORDER EXAMPLE
EJEMPLO DE REFERENCIA

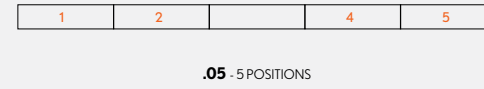

Create an OKKO like the one in the example. Crea un OKKO como el del ejemplo:

- Select PROFILE. *Selecciona PERFIL.* 210012.95.PN.XX
- Select LED MODULE and quantity. *Selecciona el modulo LED y la cantidad.* 110004.95.XX.XX.ST9.XX (4Qty./Uds.)
- Add LED MODULES' position. *Añade la posición de los módulos LED.* 1,2,4,5
- Add number of OPAQUE diffusers. *Añade el número de difusores OPAQUE.* ACC210012.95.XX (1Qty./Uds.)
- Verify DRIVER depending on the number of LED modules. *Verifica el DRIVER dependiendo del número de módulos LED.* DR210012.02.XX

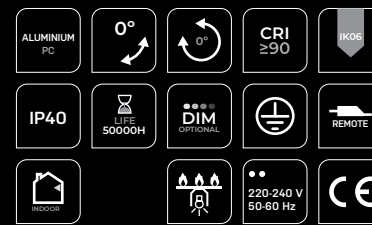
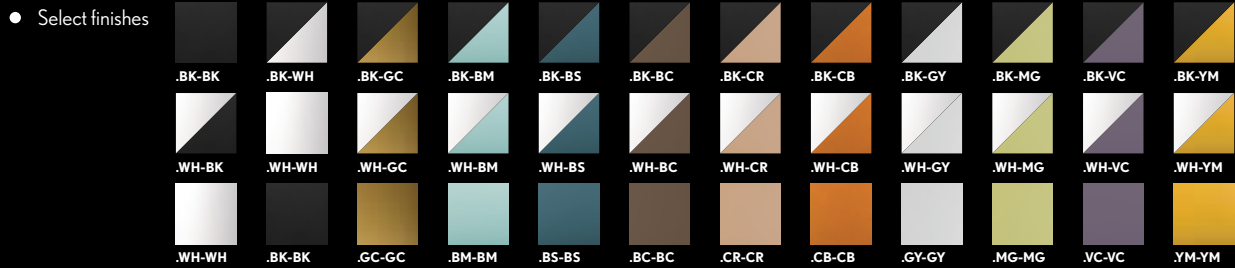

OKKO
MODULAR LINE
REF 210012.PN | 210012.SR



PHOTOMETRY

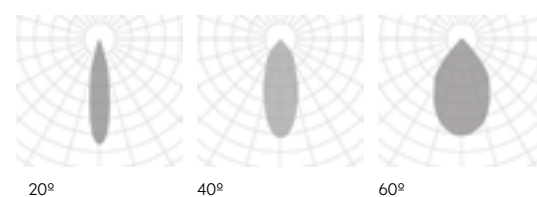

INCLUDED (.PN)



PROFILE

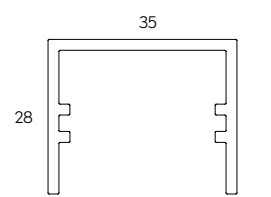

PENDANT | SURFACE



FINISHES

● COLORS



DIMENSIONS

◆ LENGTHS mm.

794 | 1189 | 1584 | 1979

LIGHTING OPTIONS

■ BEAM ANGLE

20° | 40° | 60°

POWER

STANDARD

CRI

90

COLOR TEMPERATURE

2700K | 3000K | 4000K

▼ DIMMABLE OPTIONS

DALI | 1.10 | PUSH

▲ LIGHT DISTRIBUTION

DOWN

LUMINAIRE INCLUDES

.PN

2 x Suspension cables 3m
NON-DIM DOWN or DIM DOWN: 1 x Feed Hose 3 x 0,75mm²

.SR

Surface mounting kit



SOON



ON DEMAND

Special RAL Color
Emergency Lighting*
Custom dimensions
Motion Detection
Wireless Control Options (Casambi)



* Delivered separately
(not installed in luminaire).

INSTALLATIONS

.PN
PENDANT

·210013 OKKO PLUS MODULAR
LINE | PN - Pag. 154

.SR
SURFACE

·210013 OKKO PLUS MODULAR
LINE | SR - Pag. 154

.RF
RECESSED FRAME

·410013 OKKO PLUS MODULAR |
RF-Pag. 470



OKKO PLUS MODULAR LINE

REF 210013.PN | 210013.SR

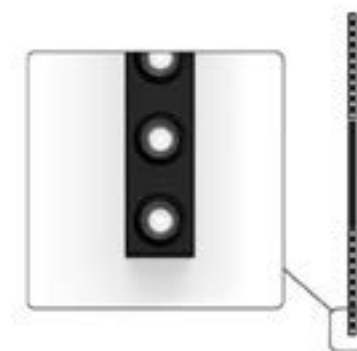

OKKO PLUS MODULAR LINE	REF.	DIMENSION	FINISH	POSITIONS
	210013	.02	●	2
		.03		3
		.04		4
		.05		5



Reference order | 210013.XX | .SR | .PN | .XX

OKKO PLUS LINE LED MODULES	REF.	DIMENSION	FINISH	OPTIC OPTIONS	POWER	CRI	LUMEN	WATT	mA	SKETCH	
	110005	.10	●	.20	.ST	.9	947	1058	1122	12	500
				.40							
				.60							

Reference order | 110005.10.XX.XX | .ST9.XX

OKKO PLUS LINE OPAQUE	REF.	DIMENSION	FINISH
	ACC210013	.10	●
			○

Reference order | ACC210013.10.XX

OKKO PLUS LINE DRIVER	DIMENSION	DIMM
DR210013	.01	1 - 5 modules
	.02	6 - 9 modules
	.03	10 - 13 modules
	.04	14 - 17 modules
	.05	18 - 20 modules

Reference order | DR210013.XX.XX

COVER KIT	REF.	FINISH
	TF25	●
		○

Reference order | TF25 | .SR | .PN | .XX

Select finishes

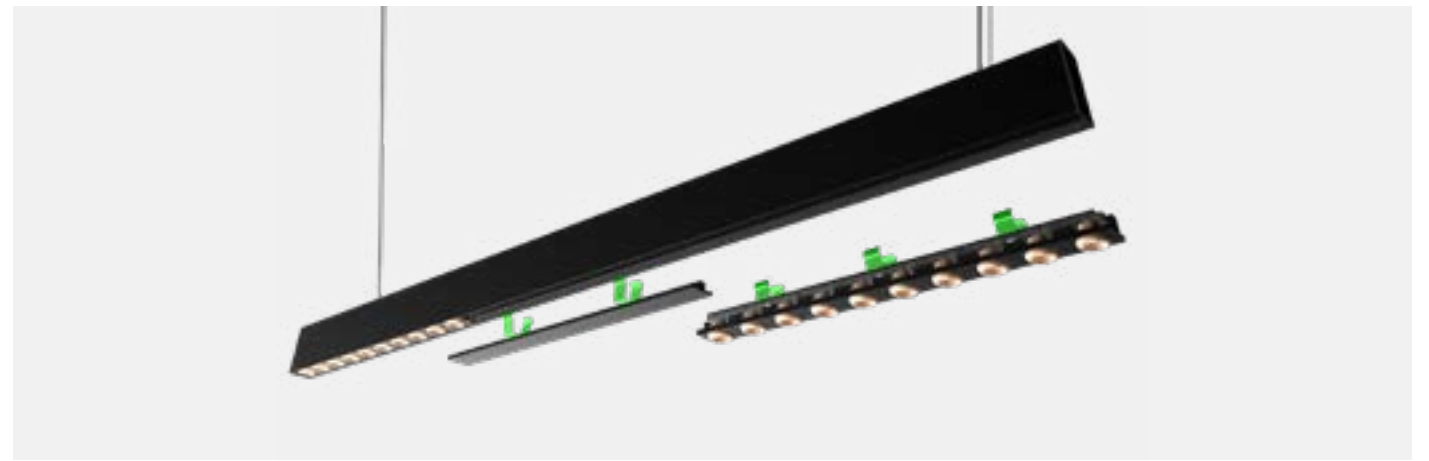

Not-included, please select:

CONNECTION BOX AND DRIVER BOX FOR REMOTE DRIVER	DRIVER BOX NON-DIMM	DRIVER BOX DIMMABLE	FINISH
			●
CB09.12	CB04.OP *	CB09.32	CB09.40

* No finish color, use this reference as it is (CB04.OP). Sin acabado de color, la referencia es tal cual (CB04.OP)

Reference order | CBXXXX.XX

SUSPENSION KIT	REF.	DIMENSION	FINISH
	SC05	5M.	.SA
	SC07	7M.	
	SC10	10M.	

Reference order | SCXX.SA

REFERENCE ORDER EXAMPLE
EJEMPLO DE REFERENCIA



.05 - 5 POSITIONS

Create an OKKO PLUS like the one in the example. Crea un OKKO PLUS como el del ejemplo:

- Select PROFILE. *Selecciona PERFIL.* 210013.95.PN.XX
- Select LED MODULE and quantity. *Selecciona el modulo LED y la cantidad.* 110005.95.XX.XX.ST9.XX (4 Qty./Uds.)
- Add LED MODULES' position. *Añade la posición de los módulos LED.* 1,2,4,5
- Add number of OPAQUE diffusers. *Añade el número de difusores OPAQUE.* ACC210013.95.XX (1Qty./Uds.)
- Verify DRIVER depending on the number of LED modules. *Verifica el DRIVER dependiendo del número de módulos LED.* DR210013.02.XX



OKKO PLUS MODULAR LINE

REF 210013.PN | 210013.SR

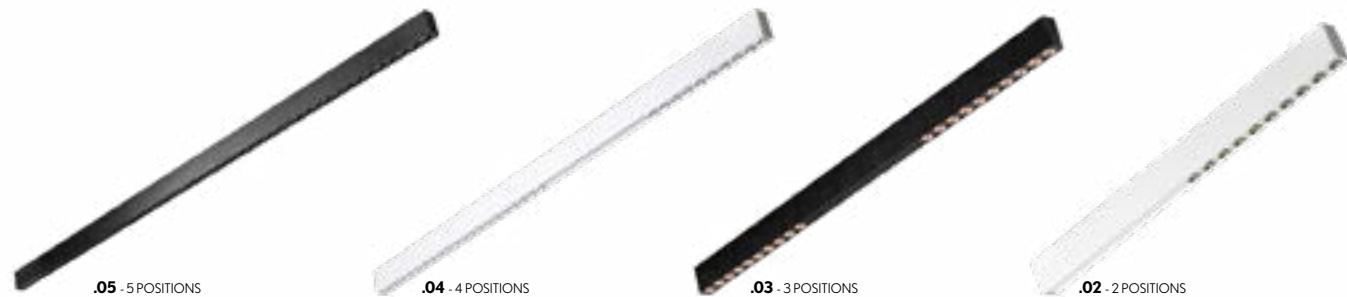

PHOTOMETRY

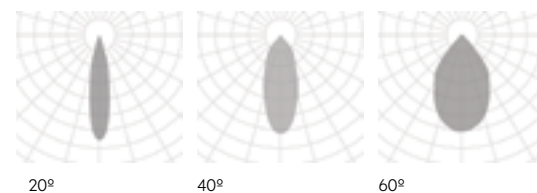

INCLUDED (.PN)

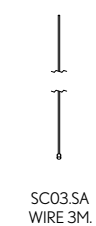

PROFILE

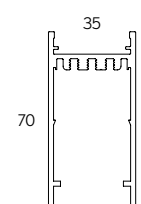

PENDANT | SURFACE



FINISHES

● PROFILE COLORS



● EYE COLORS



DIMENSIONS

● LENGTHS

1m

LIGHTING OPTIONS

■ DIFFUSERS

ACRYLIC

POWER

STANDARD

CRI

90

COLOR TEMPERATURE

2700K | 3000K | 4000K |

▼ DIMMABLE OPTIONS

-

▲ LIGHT DISTRIBUTION

DOWN

LUMINAIRE INCLUDES

.PN

2 x Suspension cables 3m (each 2m)
NON-DIM DOWN: 1 x Feed Hose 3 x 0,75mm²

.SR

Surface mounting kit

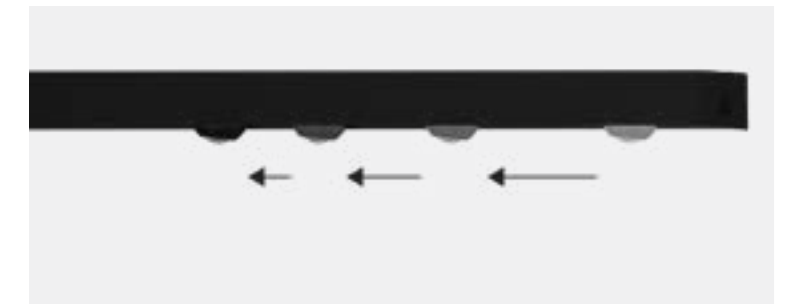

.SR
.PN

PENDANT | SURFACE

INSTALLATIONS

.PN
PENDANT

·210016 EYE|PN
Pag. 158

.SR
SURFACE

·210016 EYE|SR
Pag. 158

.TR
TRIMLESS

·210016 EYE|TR
Pag. 610



EYE

REF 210016.PN | 210016.SR

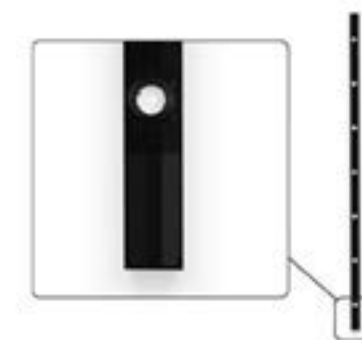

EYE	REF.	DIMENSION	FINISH	SKETCH
	210016	.01 1m.	.BK-BK .WH-WH	

Reference order | 210016.XX | .SR | .PN | .XX

48V TRANSFORMER	DIMENSION	WATT
DR48	.01	75
	.02	120
	.03	200

Reference order | DR48.XX

EYE MODULE	REF.	DIMENSION	FINISH	OPTIC OPTIONS	POWER	CRI	LUMEN			WATT	VdC	DIMM	SKETCH
							.27	.30	.40				
	20210	.01	●	.AC	.ST	.9	360	420	475	8	48	-	

Reference order | 20210.01.XX.AC.ST.9.XX

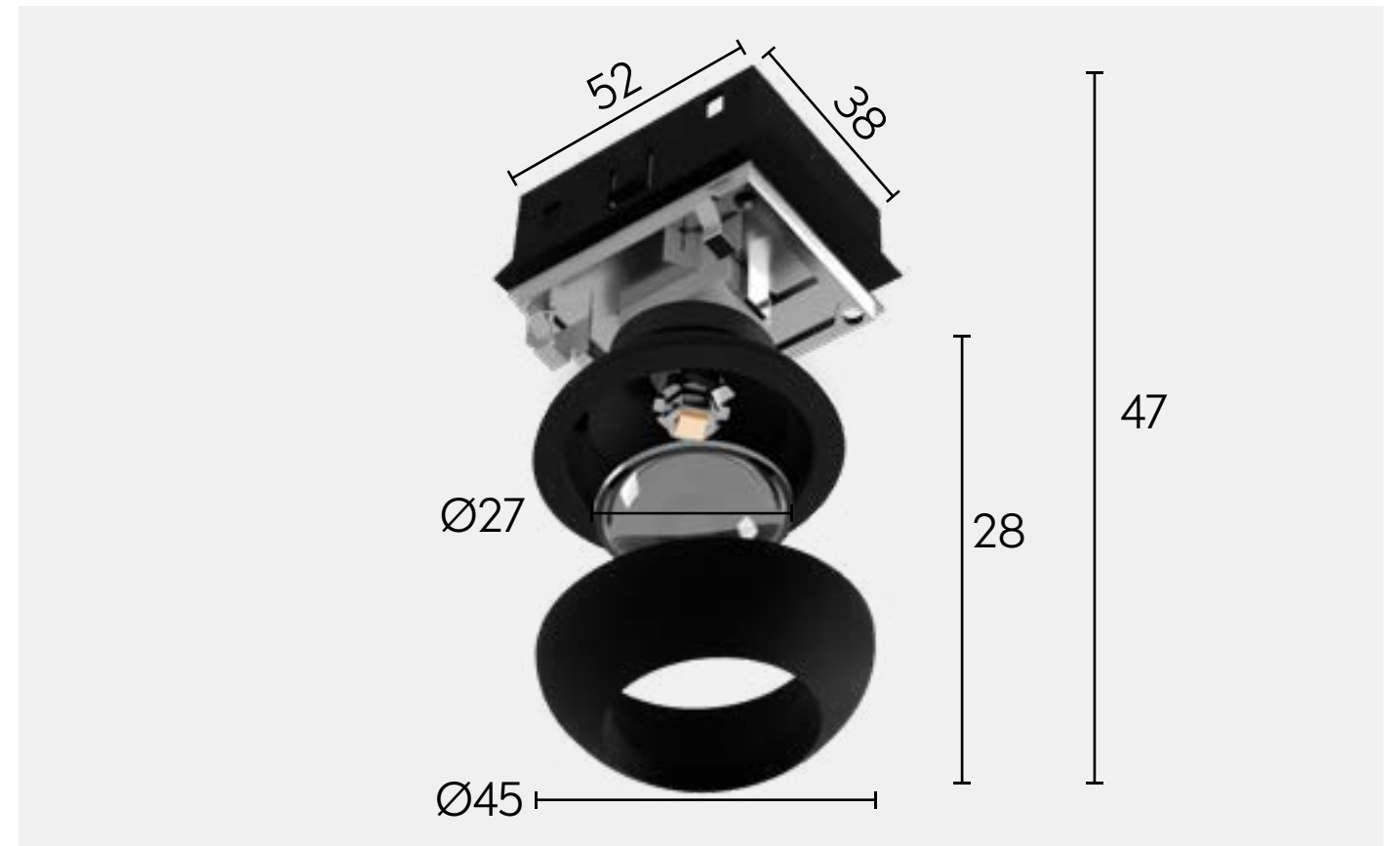

OPTIONS (.PN)

SUSPENSION KIT	REF.	DIMENSION	FINISH
	SC05	5M.	.SA
	SC07	7M.	
	SC10	10M.	

Reference order | SCXX.SA

SUSPENSION ROD	REF.	DIMENSIONS	mm	FINISH
	SC21	.60	600	●
		.80	800	
		.100	1000	

Reference order | SC21.XX.XX

BOXES (.PN) Not-included please select

CONNECTION BOX	FINISH
	●

Reference order | CB09.12.XX

COMPONENTS

COVER KIT	REF.	FINISH
	TF16	●

Reference order | TF16 | .SR | .PN | .XX

LINEAR JOINT + FLEXIBLE JOINT CONNECTOR	FINISH
	●

Reference order | UR16.XX

POWER FEEDER UNIT	FINISH
	●

Reference order | ACC210016.CA.XX

Select profile finishes



.WH-WH .BK-BK

Select eye finishes



.WH-WH .BK-BK .GC-GC



EYE

REF 210016.PN | 210016.SR

PHOTOMETRY



OPAL

INCLUDED (.PN)

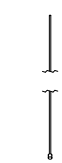

SC03.SA
WIRE 3M.

PROFILE

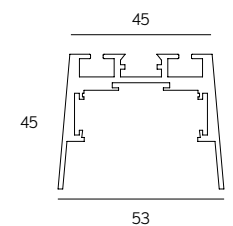

45

53

PENDANT | SURFACE

.SR
.PN

PENDANT | SURFACE

MINI
PATRICIA ROUND LENSES

MINI
PATRICIA ZOOM

MINI
PATRICIA .02

MINI
PATRICIA .01

MINI
PATRICIA FLAT

MINI
PATRICIA LOL

MINI
MOTION LENSES

MINI LED
MODULES

ALARIK MINI

**Mastering light has never
been so easy**

Incredibly dynamic, that's the look of lighting with the Alarik Mini family. A collection of almost gadget-like models with an important mission, to get the absolute best from a lighting system.

***Jugar con luz nunca ha sido
tan fácil***

Dinamismo, así es la atracción que provoca iluminar con la familia Alarik Mini. Un conjunto de modelos que casi parecen gadgets al servicio de una "importante misión": sacar todo el jugo posible a una instalación de luminarias.

new



FINISHES

● COLORS



DIMENSIONS

● LENGTHS

PER METER

COMPONENTS

- MINI PATRICIA
- MINI PATRICIA LOL
- MINI PATRICIA ZOOM
- MINI MOTION LENSES
- MINI LENSES
- MINI LED MODULES
- MINI PATRICIA FLAT
- MINI PATRICIA ROUND LENSES

POWER

STANDARD

CRI

90

COLOR TEMPERATURE

2700K | 3000K | 4000K

▼ DIMMABLE OPTIONS

DALI

▲ LIGHT DISTRIBUTION

DOWN

LUMINAIRE INCLUDES

.SR

Surface mounting kit

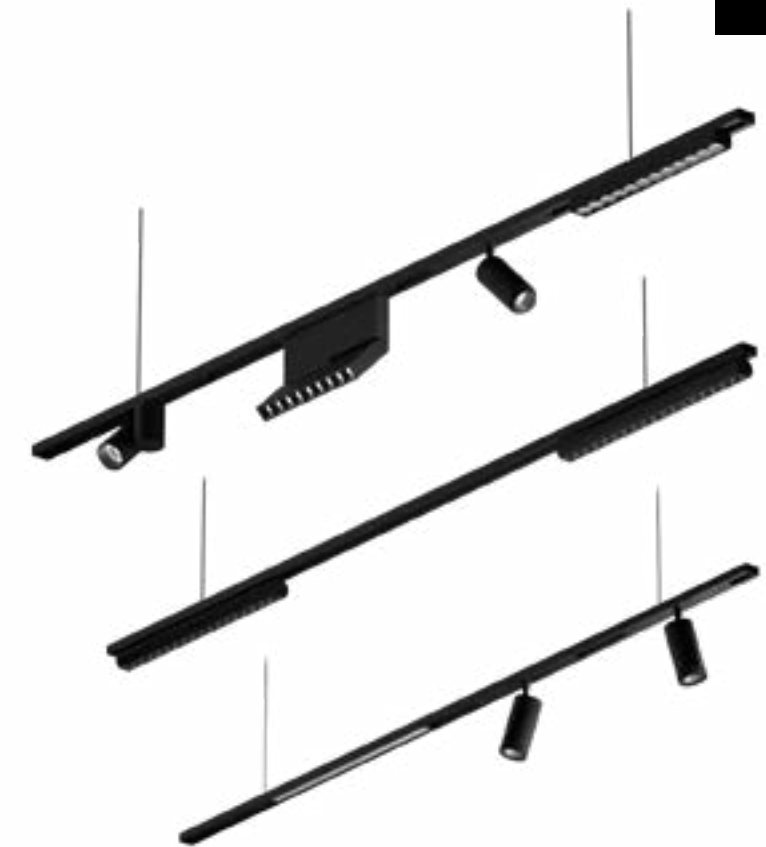

ON DEMAND
Profile Special RAL Color
Custom dimensions

PENDANT | SURFACE

INSTALLATIONS



.PN
PENDANT

·210006 ALARIK MINI | PN
Pag. 164



.SR
SURFACE

·210006 ALARIK MINI | SR
Pag. 164



.TR
TRIMLESS

·210006 ALARIK MINI | TR
Pag. 616

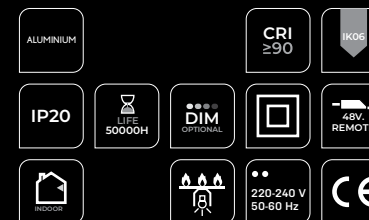

ALARIK MINI

REF 210006.PN | 210006.SR

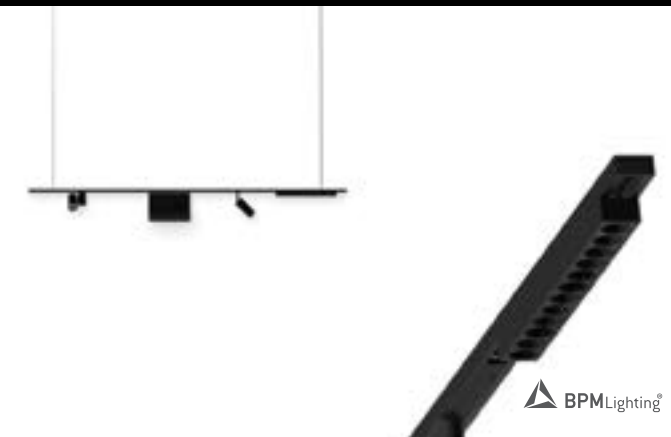
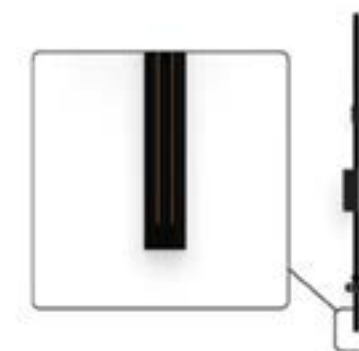

ALARIK MINI	DIMENSION	FINISH	SKETCH
	210006	.01 1m	

Reference order | 210006.XX.SR.PN.XX

48V TRANSFORMER	DIMENSION	WATT
DR48	.01	75
	.02	120
	.03	200

Reference order | DR48.XX

POWER FEEDER	REF.	FINISH	SKETCH
	ACC210006.CA	.BK-BK .WH-WH	

Reference order | ACC210006.CA.XX

MINI PATRICIA *1	REF.	DIMENSION	FINISH	OPTIC OPTIONS	POWER	CRI	K	LUMEN	WATT	VdC	DIMM	SKETCH
	450001	.01	●	.15 .24 .30	.ST	.9	.27	130	5	48	.DA	
							.30	145				
							.40	185				
	450001	.02	●	.15 .24 .30	.ST	.9	.27	396	8	48	.DA	
							.30	421				
							.40	476				

Reference order | 450001.XX.XX.XX.ST9.XX.XX

MINI PATRICIA LOL *1	REF.	DIMENSION	FINISH	OPTIC OPTIONS	POWER	CRI	K	LUMEN	WATT	VdC	DIMM	SKETCH
	450002	.01	●	.15 .24 .36	.ST	.9	.27	397	6	48	.DA	
							.30	425				
							.40	460				

Reference order | 450002.XX.XX.XX.ST9.XX.XX

*1 LED Modules are Class III.
Los módulos LED son Clase III.

MINI PATRICIA ZOOM *1	REF.	DIMENSION	FINISH	OPTIC OPTIONS	POWER	CRI	K	LUMEN	WATT	VdC	DIMM	SKETCH
	450003	.01	●	.15-40	.ST	.9	.27	169	6	48	.DA	
							.30	172				
							.40	212				

Reference order | 450003.XX.XX.XX.ST9.XX.XX

MINI PATRICIA FLAT *1	REF.	DIMENSION	FINISH	OPTIC OPTIONS	POWER	CRI	K	LUMEN	WATT	VdC	DIMM	SKETCH
	450007	.01	●	.15 .30 .36	.ST	.9	.27	425	6	48	.DA	
							.30	465				
							.40	481				

Reference order | 450007.XX.XX.XX.ST9.XX.XX

MINI PATRICIA ROUND LENSES *1	REF.	DIMENSION	FINISH	OPTIC OPTIONS	POWER	CRI	K	LUMEN	WATT	VdC	DIMM	SKETCH
	450008	.01	●	.30 .36 .60	.ST	.9	.27	550	9	48	.DA	
							.30	563				
							.40	648				

Reference order | 450008.XX.XX.XX.ST9.XX.XX

MINI LENSES *1	REF.	DIMENSION	FINISH	OPTIC OPTIONS	POWER	CRI	K	LUMEN	WATT	VdC	DIMM	SKETCH
	450005	.01	●	.23 .28 .36	.ST	.9	.27	538	9	48	.DA	
							.30	590				
							.40	682				

Reference order | 450005.XX.XX.XX.ST9.XX.XX

• Select finishes

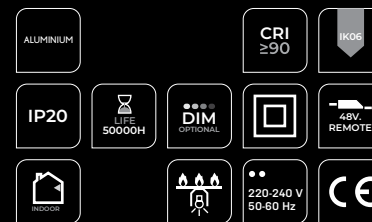
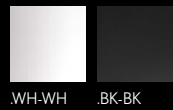

ALARIK MINI

REF 210006.PN | 210006.SR

PHOTOMETRY

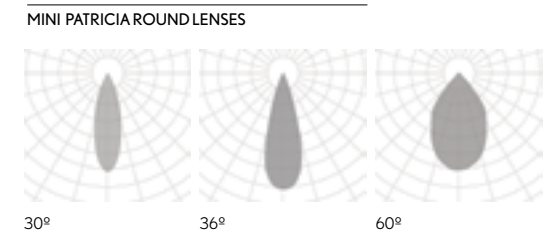
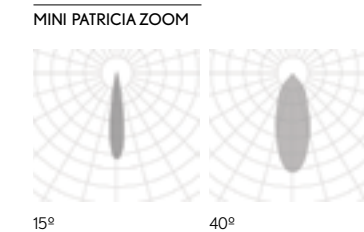
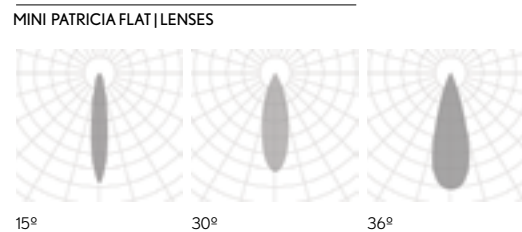
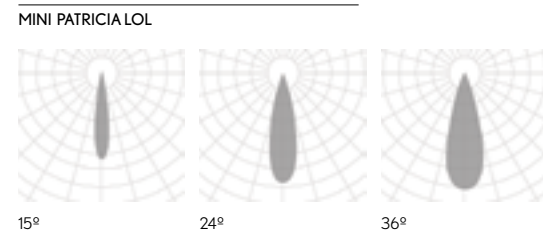
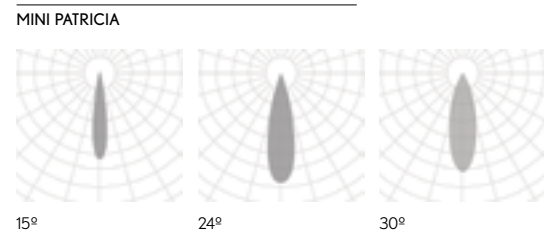

SR
PN
PENDANT | SURFACE

MINI MOTION LENSES *1	REF.	DIMENSION	FINISH	OPTIC OPTIONS	POWER	CRI	K	LUMEN	WATT	V4C	DIMM	SKETCH
	450004	.01	●	.23 .28 .36	.ST	.9	.27	547	9	48	.DA	
							.30	570				
							.40	634				

Reference order 450004.XX.XX.XX.ST9.XX.XX

MINI LED MODULES *1	REF.	DIMENSION	FINISH	DIFFUSER	POWER	CRI	K	LUMEN	WATT	V4C	DIMM	SKETCH
	450006	.01	.BK-BK	.OP	.ST	.9	.27	473	6	48	-	
							.30	478				
							.40	486				
	450006	.02	.BK-BK	.OP	.ST	.9	.27	997	12	48	-	
							.30	1003				
							.40	1011				
	450006	.03	.BK-BK	.OP	.ST	.9	.27	2037	24	48	-	
							.30	2045				
							.40	2060				

Reference order 450006.XX.BK-BK.XX.ST9.XX

COMPONENTS

COVER KIT	REF.	FINISH
	TF21	●

Reference order TF21.SR.PN.XX

SUSPENSION KIT	REF.
	ACC210006.SC

Reference order ACC210006.SC

SUSPENSION KIT WITH 48 TRANSFORMER BOX*2	REF.
	ACC20224.PKDB

Reference order ACC20224.PKDB

SUSPENSION KIT WITH 48 TRANSFORMER BOX*3	REF.
	CB08.30

Reference order CB08.30

REMOTE 48V TRANSFORMER BOX	48V TRANSFORMER BOX	FINISH
		●
CB09.12	CB06.40	

Reference order XXXX.XX

*1 LED Modules are Class III. Los módulos LED son Clase III.
*2 Works with DR48.01 and .03. Funciona con DR48.01 y .03.
*3 Works with DR48.02. Funciona con DR48.02.

JOINTS & CONNECTORS

LINEAR JOINT	ANGLE JOINT	CROSS JOINT	T-JOINT	WALL-CEILING JOINT	FINISH
					● .BK-BK .WH-WH
UR21	UL21	UC21	UT21	UV21	

Reference order XX.XX

CURVE JOINT KIT *4	REF.	DIMENSION	DEGREE	FINISH
	ACC210006	.01	45°	.BK-BK .WH-WH

Reference order ACC210006.XX.45.XX

CURVE JOINT KIT *4	REF.	DIMENSION	DEGREE	FINISH
	ACC210006	.01	90°	.BK-BK .WH-WH

Reference order ACC210006.XX.90.XX

*4 LED components can not be installed in curve joints. Los componentes LED no se pueden instalar en las uniones curvas.

ALUMINIUM

CRI ≥90

IP20

LIFE 50000H

DIM OPTIONAL

48V. REMOTE

220-240 V 50-60 Hz

CE

Select finishes

WH-WH BK-BK

ALARIK

MINI

REF 210006.PN | 210006.SR

PHOTOMETRY

MINI LENSES | MINI MOTION LENSES

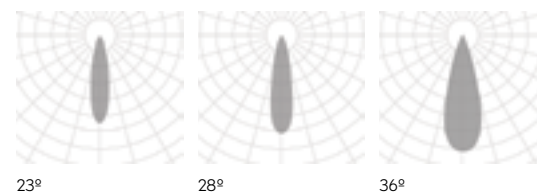

PHOTOMETRY

MINI LED MODULES

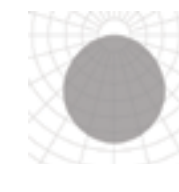

PROFILE

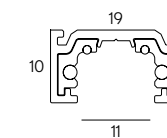

SR
PN
PENDANT | SURFACE

new



FINISHES

● COLORS



DIMENSIONS

● LENGTHS

PER METER

COMPONENTS

MINI PATRICIA
MINI PATRICIA LOL
MINI PATRICIA ZOOM
MINI MOTION LENSES
MINI LENSES
MINI LED MODULES
MINI PATRICIA FLAT
MINI PATRICIA ROUND LENSES

POWER

STANDARD

CRI

90

COLOR TEMPERATURE

2700K | 3000K | 4000K

▼ DIMMABLE OPTIONS

DALI

▲ LIGHT DISTRIBUTION

DOWN

LUMINAIRE INCLUDES

.SR

Surface mounting kit

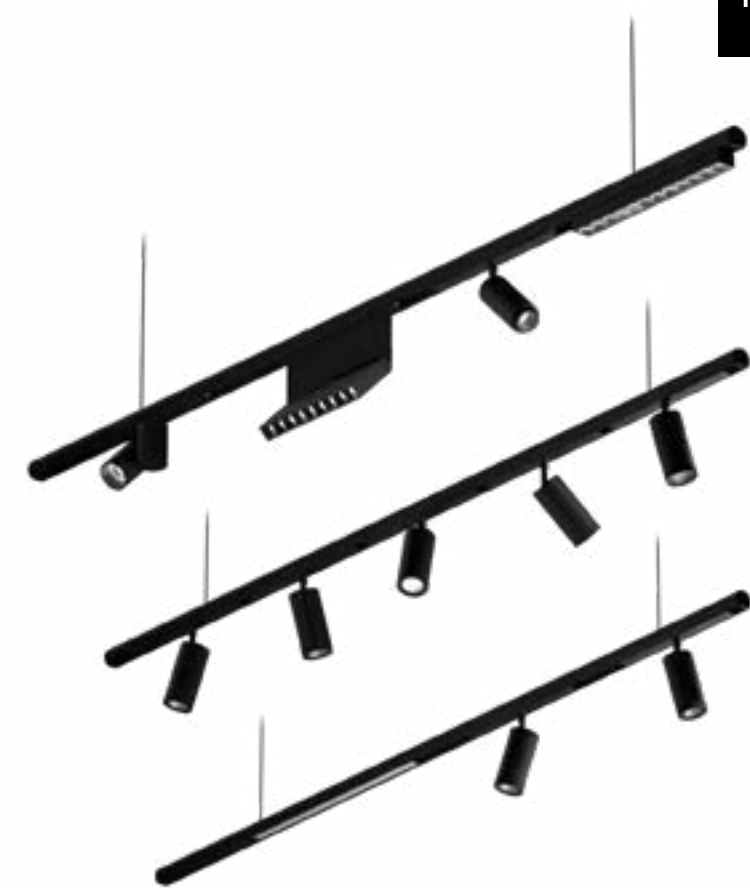

ON DEMAND
Profile Special RAL Color
Custom dimensions

.PN

PENDANT

INSTALLATIONS



.PN
PENDANT

·210004 ALARIK MINIROUND | PN
Pag. 170

.SR
SURFACE

·210004 ALARIK MINIROUND | SR
Pag. 170

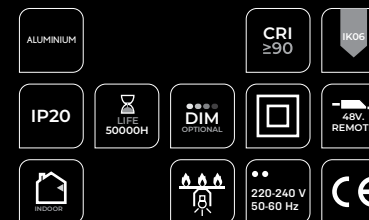

ALARIK MINI ROUND

REF 210004.PN | 210004.SR

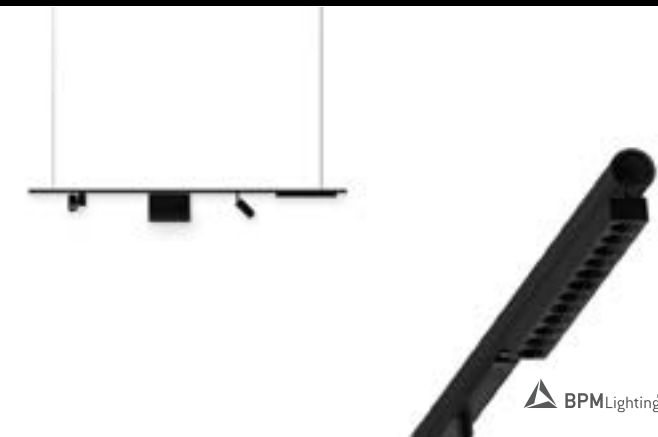
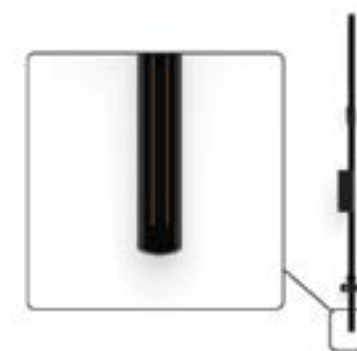

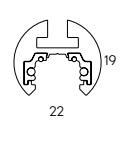
ALARIK MINI ROUND	REF.	DIMENSION	FINISH	SKETCH
	210004	.01 1m.	●	



Reference order | 210004.XX.SR.PN.XX

48V TRANSFORMER	DIMENSION	WATT
DR48	.01	75
	.02	120
	.03	200

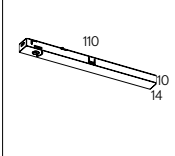
Reference order | DR48.XX

POWER FEEDER	REF.	FINISH	SKETCH
	ACC210004.CA	● .BK-BK .WH-WH	

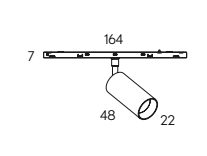
Reference order | ACC210004.CA.XX

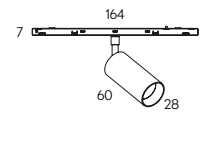
MINI PATRICIA *1	REF.	DIMENSION	FINISH	OPTIC OPTIONS	POWER	CRI	K	LUMEN	WATT	VdC	DIMM	SKETCH
	450001	.01	●	.15 .24 .30	.ST	.9	.27	130	5	48	.DA	
							.30	145				
							.40	185				
	450001	.02	●	.15 .24 .30	.ST	.9	.27	396	8	48	.DA	
							.30	421				
							.40	476				

Reference order | 450001.XX.XX.XX.ST9.XX.XX

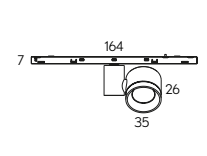
MINI PATRICIA LOL *1	REF.	DIMENSION	FINISH	OPTIC OPTIONS	POWER	CRI	K	LUMEN	WATT	VdC	DIMM	SKETCH
	450002	.01	●	.15 .24 .36	.ST	.9	.27	397	6	48	.DA	
							.30	425				
							.40	460				

Reference order | 450002.XX.XX.XX.ST9.XX.XX

*1 LED Modules are Class III.
Los módulos LED son Clase III.

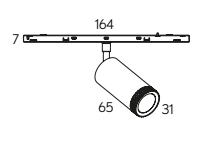
MINI PATRICIA ZOOM *1	REF.	DIMENSION	FINISH	OPTIC OPTIONS	POWER	CRI	K	LUMEN	WATT	VdC	DIMM	SKETCH
	450003	.01	●	.15-40	.ST	.9	.27	169	6	48	.DA	
							.30	172				
							.40	212				

Reference order | 450003.XX.XX.XX.ST9.XX.XX

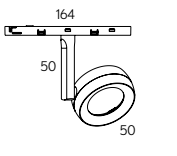
MINI PATRICIA FLAT *1	REF.	DIMENSION	FINISH	OPTIC OPTIONS	POWER	CRI	K	LUMEN	WATT	VdC	DIMM	SKETCH
	450007	.01	●	.15 .30 .36	.ST	.9	.27	425	5	48	.DA	
							.30	465				
							.40	481				

Reference order | 450007.XX.XX.XX.ST9.XX.XX

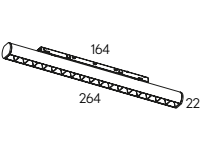
MINI PATRICIA ROUND LENSES *1	REF.	DIMENSION	FINISH	OPTIC OPTIONS	POWER	CRI	K	LUMEN	WATT	VdC	DIMM	SKETCH
	450008	.01	●	.30 .36 .60	.ST	.9	.27	550	9	48	.DA	
							.30	563				
							.40	648				

Reference order | 450008.XX.XX.XX.ST9.XX.XX

• Select finishes

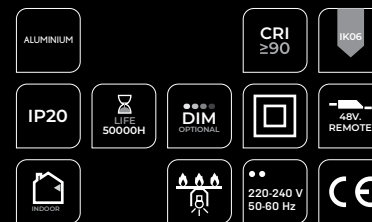
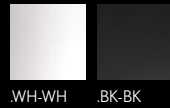

ALARIK MINI ROUND

REF 210004.PN | 210004.SR

PHOTOMETRY

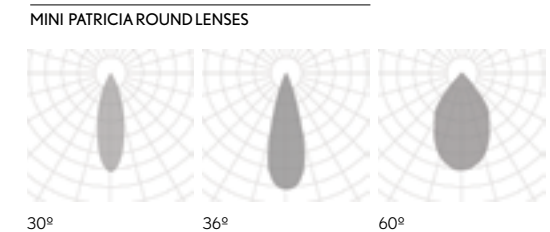
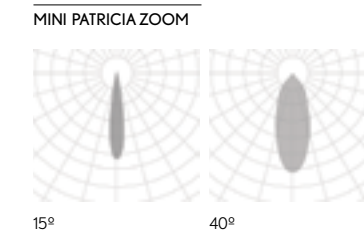
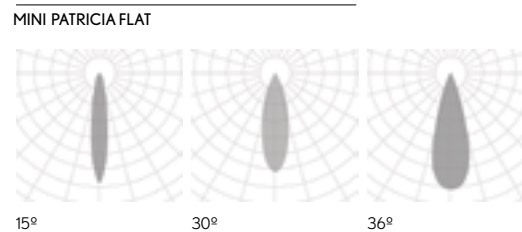
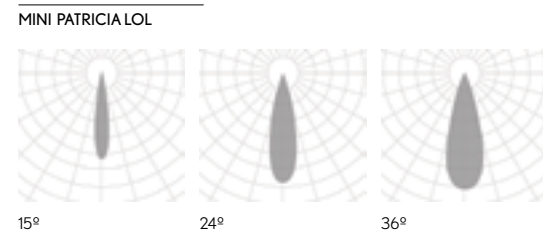
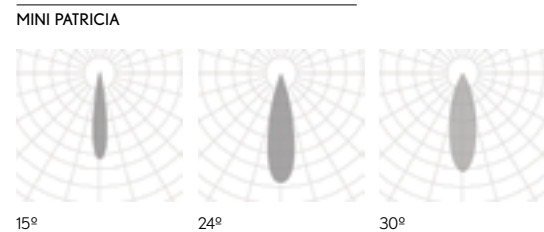

MINI LENSES *1	REF.	DIMENSION	FINISH	OPTIC OPTIONS	POWER	CRI	K	LUMEN	WATT	VdC	DIMM	SKETCH
	450005	.01	●	.23 .28 .36	.ST	.9	.27	538	9	48	.DA	
							.30	590				
							.40	682				

Reference order 450005.XX.XX.XX.ST9.XX.XX

MINI MOTION LENSES *1	REF.	DIMENSION	FINISH	OPTIC OPTIONS	POWER	CRI	K	LUMEN	WATT	VdC	DIMM	SKETCH
	450004	.01	●	.23 .28 .36	.ST	.9	.27	547	9	48	.DA	
							.30	570				
							.40	634				

Reference order 450004.XX.XX.XX.ST9.XX.XX

MINI LED MODULES *1	REF.	DIMENSION	FINISH	DIFFUSER	POWER	CRI	K	LUMEN	WATT	VdC	DIMM	SKETCH
	450006	.01	.BK-BK	.OP	.ST	.9	.27	473	6	48	-	
							.30	478				
							.40	486				
	450006	.02	.BK-BK	.OP	.ST	.9	.27	997	12	48	-	
							.30	1003				
							.40	1011				
	450006	.03	.BK-BK	.OP	.ST	.9	.27	2037	24	48	-	
							.30	2045				
							.40	2060				

Reference order 450006.XX.BK-BK.XX.ST9.XX

Select finishes

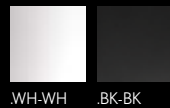

.WH-WH .BK-BK

COMPONENTS

COVER KIT	REF.	FINISH
	TF22	●

Reference order TF22.PN.XX

SUSPENSION KIT	REF.
	ACC210004.SC

Reference order ACC210004.SC

SUSPENSION KIT WITH 48 TRANSFORMER BOX*2	REF.
	ACC20224.PKDB

Reference order ACC20224.PKDB

SUSPENSION KIT WITH 48 TRANSFORMER BOX*3	REF.
	CB08.30

Reference order CB08.30

REMOTE 48V TRANSFORMER BOX	48V TRANSFORMER BOX	FINISH
		●
CB09.12	CB06.40	

Reference order XXXX.XX

JOINTS & CONNECTORS

LINEAR JOINT	FINISH
	●
UR21	.BK-BK .WH-WH

Reference order UR21.XX

*1 LED Modules are Class III. Los módulos LED son Clase III.
*2 Works with DR48.01 and .03. Funciona con DR48.01 y .03.
*3 Works with DR48.02. Funciona con DR48.02.

PHOTOMETRY

MINI LENSES | MINI MOTION LENSES

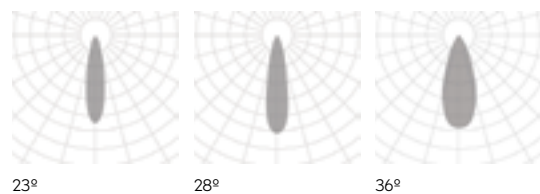

23° 28° 36°

PHOTOMETRY

MINI LED MODULES

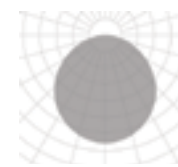

OPAL

PROFILE

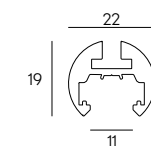

11

PENDANT

ALARIK MINI ROUND

REF 210004.PN | 210004.SR

Mastering light has never been so easy

It's playtime! Lighting design with Alarik family is an exercise of creativity. Freedom, functionality, uniqueness... In short, unbridled flexibility and total control over the final result.

Jugar con luz nunca ha sido tan fácil

¡Que empiece el juego! Iluminar con la familia Alarik es lo más parecido a un ejercicio de ingenio. Libertad, funcionalidad, singularidad... en definitiva, diseño sin ataduras y siempre con el control absoluto del resultado a obtener.

ALARIK SLIM

new



FINISHES

● COLORS



DIMENSIONS

● LENGTHS

PER METER

COMPONENTS

SLIM PATRICIA
SLIM PATRICIA ZOOM
SLIM LED BALL
SLIM TUBE
SLIM WALL WASHER
SLIM LENSES
SLIM MOTION LENSES
SLIM LED MODULES

POWER

STANDARD

CRI

90

COLOR TEMPERATURE

2700K | 3000K | 4000K

▼ DIMMABLE OPTIONS

DALI | 1.10

▲ LIGHT DISTRIBUTION

DOWN

LUMINAIRE INCLUDES

.SR

Surface mounting kit



ON DEMAND
Profile Special RAL Color
Custom dimensions



PENDANT | SURFACE

INSTALLATIONS



.PN
PENDANT

·20224 ALARIK SLIM |PN
Pag. 178



.SR
SURFACE

·20224 ALARIK SLIM |SR
Pag. 178



.RF
RECESSED FRAME

·20224 ALARIK SLIM |RF
Pag. 428



.TR
TRIMLESS

·20224 ALARIK SLIM |TR
Pag. 622

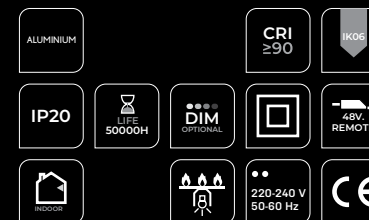

ALARIK SLIM

REF 20224.PN | 20224.SR

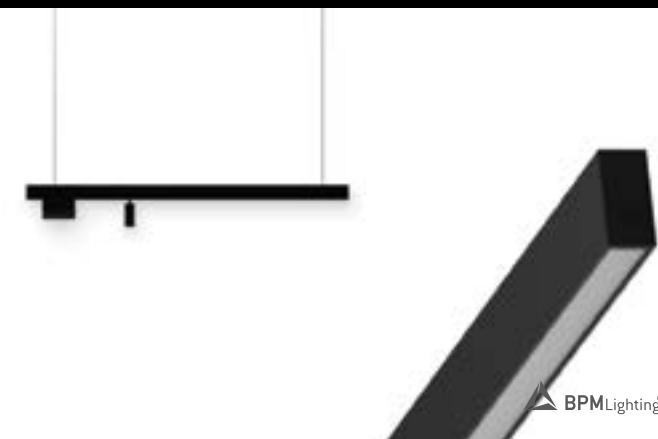

ALARIK SLIM	REF.	DIMEN-SION	FINISH	SKETCH
	20224	.01 1m	●	

Reference order 20224.XX.PN.SR.XX

48V TRANSFORMER	DIMENSION	WATT
DR48	.01	75
	.02	120
	.03	200

Reference order DR48.XX

INTEGRATED POWER	REF.	WATT
	10246.DR (404x43x22mm)	200W

Reference order 10246.DR

SLIM PATRICIA *1	REF.	DIMEN-SION	FINISH	OPTIC OPTIONS	POWER	CRI	K	LUMEN	WATT	VdC	DIMM	SKETCH
	11544	.01	●	.15 .38 .60	.ST	.9	.27	525	8	48	.DA .D1	
							.30	565				
							.40	660				
	11544	.02	●	.15 .38 .60	.ST	.9	.27	1070	15	48	.DA .D1	
							.30	1147				
							.40	1267				

Reference order 11544.XX.XX.XX.ST9.XX.XX

SLIM PATRICIA ZOOM *1	REF.	DIMEN-SION	FINISH	OPTIC OPTIONS	POWER	CRI	K	LUMEN	WATT	VdC	DIMM	SKETCH
	11546	.01	●	.15-36 .36-60	.ST	.9	.27	1888	25	48	.DA .D1	
							.30	1995				
							.40	2191				

Reference order 11546.01.XX.XX.ST9.XX.XX

SLIM LED BALL *1	REF.	DIMEN-SION	FINISH	OPTIC OPTIONS	POWER	CRI	K	LUMEN	WATT	VdC	DIMM	SKETCH
	11551	.01	●	.37	.ST	.9	.27	355	8	48	.DA .D1	
							.30	383				
							.40	396				

Reference order 11551.01.XX.XX.ST9.XX.XX

*1 LED Modules are Class III.
Los módulos LED son Clase III.

SLIM LED TUBE 20 *1	REF.	DIMEN-SION	FINISH	OPTIC OPTIONS	POWER	CRI	K	LUMEN	WATT	VdC	DIMM	SKETCH
	11553	.01	●	.20 .40	.ST	.9	.27	174	3	48	.DA .D1	
							.30	187				
							.40	212				

Reference order 11553.01.XX.XX.ST9.XX.XX

SLIM LED TUBE 40 *1	REF.	DIMEN-SION	FINISH	OPTIC OPTIONS	POWER	CRI	K	LUMEN	WATT	VdC	DIMM	SKETCH
	11552	.01	●	.20 .40	.ST	.9	.27	954	14	48	.DA .D1	
							.30	991				
							.40	1067				

Reference order 11552.01.XX.XX.ST9.XX.XX

SLIM WALL WASHER *1	REF.	DIMEN-SION	FINISH	OPTIC OPTIONS	POWER	CRI	K	LUMEN	WATT	VdC	DIMM	SKETCH
	11550	.01	.BK-BK	-	.ST	.9	.27	882	15	48	.DA .D1	
							.30	1013				
							.40	1107				

Reference order 11550.01.BK-BK.XX.ST9.XX.XX

SLIM LENSES *1	REF.	DIMEN-SION	FINISH	OPTIC OPTIONS	POWER	CRI	K	LUMEN	WATT	VdC	DIMM	SKETCH
	11548	.01	.BK-BK	.15 .38	.ST	.9	.27	725	8	48	.DA .D1	
							.30	750				
							.40	827				
	11548	.02	.BK-BK	.15 .38	.ST	.9	.27	1320	15	48	.DA .D1	
							.30	1511				
							.40	1654				

Reference order 11548.XX.BK-BK.XX.ST9.XX.XX

• Select finishes

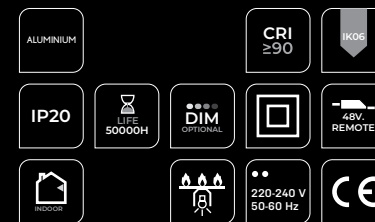
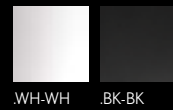

ALARIK SLIM

REF 20224.PN | 20224.SR

PHOTOMETRY

SLIM PATRICIA | SLIM PATRICIA ZOOM

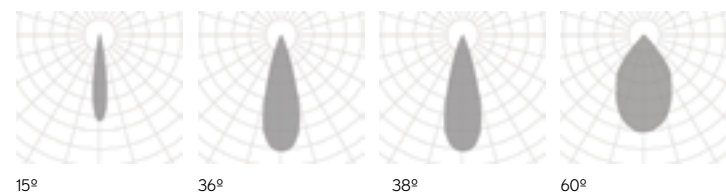

PHOTOMETRY

SLIM LED BALL | SLIM WALL WASHER



PHOTOMETRY

SLIM TUBE

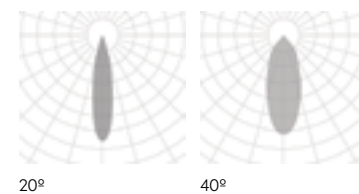

PHOTOMETRY

SLIM LENSES

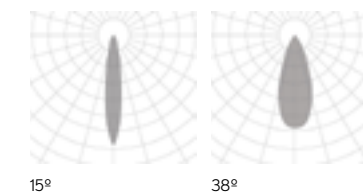

PROFILE

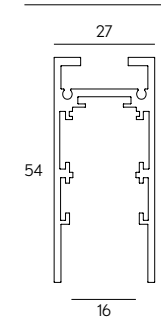

SR
PN
PENDANT | SURFACE

SLIM MOTION LENSES *1	REF.	DIMEN-SION	FINISH	OPTIC OPTIONS	POWER	CRI	K	LUMEN	WATT	VdC	DIMM	SKETCH
	11547	.01	.BK-BK	.15 .38	.ST	.9	.27	660	8	48	.DA .D1	
							.30	750				
							.40	827				

Reference order 11547.01.BK-BK.XX.ST9.XX.XX

SLIM LED MODULES *1	REF.	DIMEN-SION	FINISH	DIFFUSER	POWER	CRI	K	LUMEN	WATT	VdC	DIMM	SKETCH
	11549	.01	.BK-BK	.OP	.ST	.9	.27	558	9	48	.DA .D1	
							.30	560				
							.40	604				
	11549	.02	.BK-BK	.OP	.ST	.9	.27	1115	18	48	.DA .D1	
							.30	1120				
							.40	1208				
	11549	.03	.BK-BK	.OP	.ST	.9	.27	1670	24	48	.DA .D1	
							.30	1680				
							.40	1812				

Reference order 11549.XX.BK-BK.XX.ST9.XX.XX

COMPONENTS

COVER KIT	REF.	FINISH	SUSPENSION KIT	REF.	SUSPENSION KIT WITH 48 TRANSFORMER BOX *2	REF.	SUSPENSION KIT WITH 48 TRANSFORMER BOX *3	REF.
	TF19	.SR .PN .XX		ACC20224.SC		ACC20224.PKDB		CB08.30

Reference order TF19.SR.PN.XX Reference order ACC20224.SC Reference order ACC20224.PKDB Reference order CB08.30

REMOTE 48V TRANSFORMER BOX	48V TRANSFORMER BOX	FINISH
		.SR .PN .XX
CB09.12	CB06.40	

Reference order XXXX.XX

*1 LED Modules are Class III. Los módulos LED son Clase III.
*2 Works with DR48.01 and .03. Funciona con DR48.01 y .03.
*3 Works with DR48.02. Funciona con DR48.02.

JOINTS & CONNECTORS

LINEAR JOINT	FINISH
	.BK-BK .WH-WH

UR19.XX

ANGLE JOINT	FINISH
	.BK-BK .WH-WH

UL19.XX

WALL-CEILING JOINT	FINISH
	.BK-BK .WH-WH

UV19.XX

POWER FEEDER UNIT	FINISH
	.BK-BK .WH-WH

ACC20224.CA.XX

CURVE JOINT KIT *4	REF.	DIMEN-SION	DEGREE	FINISH	SKETCH
	ACC20224	.01	45°	.BK-BK .WH-WH	
		.02			
		.03			

Reference order ACC20224.XX.45.XX

CURVE JOINT KIT *4	REF.	DIMEN-SION	DEGREE	FINISH	SKETCH
	ACC20224	.01	90°	.BK-BK .WH-WH	
		.02			
		.03			

Reference order ACC20224.XX.90.XX

*4 LED components can not be installed in curve joints. Los componentes LED no se pueden instalar en las uniones curvas.

ALUMINIUM

CRI ≥90

IP20

LIFE 50000H

DIM OPTIONAL

48V. REMOTE

220-240 V 50-60 Hz

CE

Select finishes

.WH-WH .BK-BK

ALARIK SLIM

REF 20224.PN | 20224.SR

PHOTOMETRY

SLIM MOTION LENSES

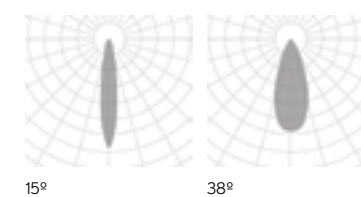

PHOTOMETRY

SLIM LED MODULES

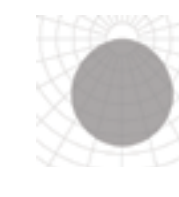

PENDANT | SURFACE

.SR

.PN

PENDANT | SURFACE

new



FINISHES

● COLORS



DIMENSIONS

● LENGTHS

PER METER

COMPONENTS

SLIM PATRICIA
SLIM PATRICIA ZOOM
SLIM LED BALL
SLIM TUBE
SLIM WALL WASHER
SLIM LENSES
SLIM MOTION LENSES
SLIM LED MODULES

POWER

STANDARD

CRI

90

COLOR TEMPERATURE

2700K | 3000K | 4000K

▼ DIMMABLE OPTIONS

DALI | 1.10

▲ LIGHT DISTRIBUTION

DOWN

LUMINAIRE INCLUDES

.SR

Surface mounting kit

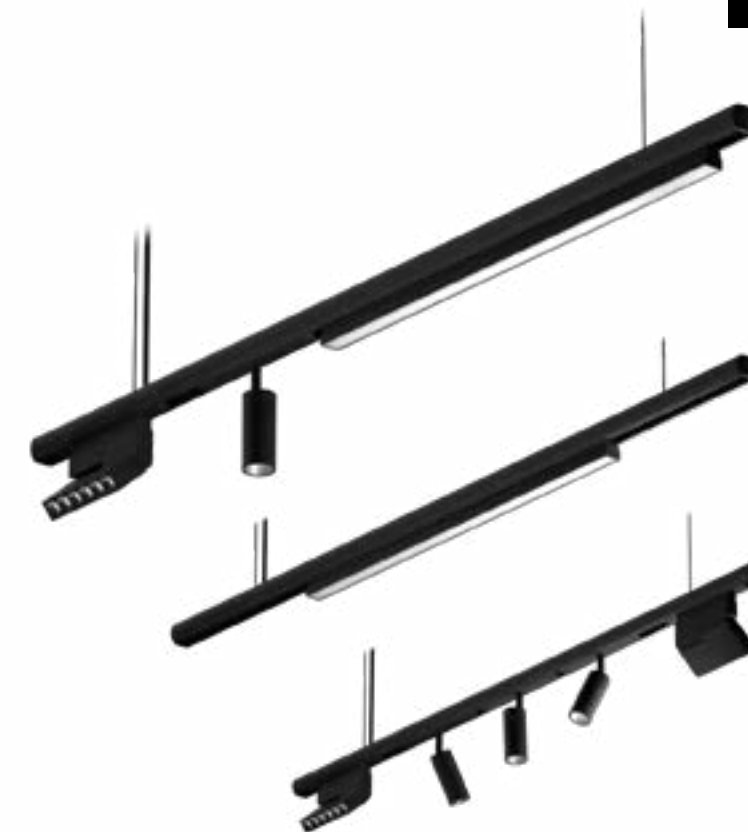

ON DEMAND
Profile Special RAL Color
Custom dimensions

.SR

.PN

PENDANT | SURFACE

INSTALLATIONS

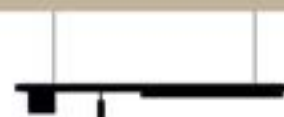

.PN
PENDANT

·210019 ALARIK SLIM ROUND | PN
Pag. 184



.SR
SURFACE

·210019 ALARIK SLIM ROUND | SR
Pag. 184

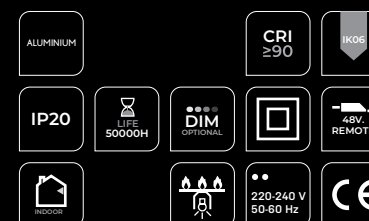

ALARIK SLIM ROUND

REF 210019.PN | 210019.SR

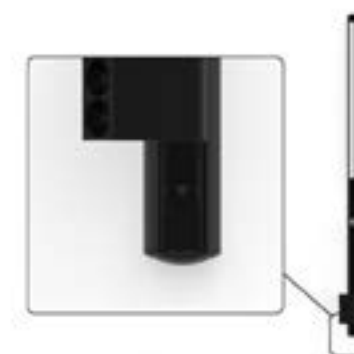

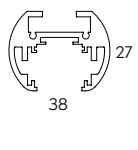

ALARIK SLIM ROUND	REF.	DIMENSION	FINISH	SKETCH
	210019	.01 1m	●	

48V TRANSFORMER	DIMENSION	WATT
DR48	.01	75
	.02	120
	.03	200

Reference order 210019.XX.PN.XX

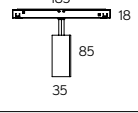
Reference order DR48.XX

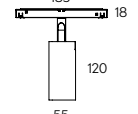
SLIM PATRICIA *1	REF.	DIMENSION	FINISH	OPTIC OPTIONS	POWER	CRI	K	LUMEN	WATT	VdC	DIMM	SKETCH
	11544	.01	●	.15 .38 .60	.ST	.9	.27	576	8	48	.DA .D1	
							.30	607				
							.40	695				
	11544	.02	●	.15 .38 .60	.ST	.9	.27	1173	15	48	.DA .D1	
							.30	1181				
							.40	1207				

Reference order 11544.XX.XX.XX.ST9.XX.XX

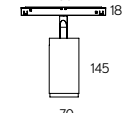
SLIM PATRICIA ZOOM *1	REF.	DIMENSION	FINISH	OPTIC OPTIONS	POWER	CRI	K	LUMEN	WATT	VdC	DIMM	SKETCH
	11546	.01	●	.15-36 .36-60	.ST	.9	.27	2038	25	48	.DA .D1	
							.30	2254				
							.40	2320				

Reference order 11546.01.XX.XX.ST9.XX.XX

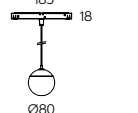
SLIM LED BALL *1	REF.	DIMENSION	FINISH	OPTIC OPTIONS	POWER	CRI	K	LUMEN	WATT	VdC	DIMM	SKETCH
	11551	.01	●	.37	.ST	.9	.27	355	8	48	.DA .D1	
							.30	383				
							.40	396				

Reference order 11551.01.XX.XX.ST9.XX.XX

*1 LED Modules are Class III.
Los módulos LED son Clase III.

• Select finishes

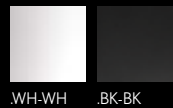

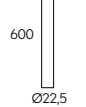
SLIM LED TUBE 20 *1	REF.	DIMENSION	FINISH	OPTIC OPTIONS	POWER	CRI	K	LUMEN	WATT	VdC	DIMM	SKETCH
	11553	.01	●	.20 .40	.ST	.9	.27	174	3	48	.DA .D1	
							.30	187				
							.40	212				

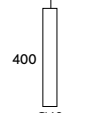

Reference order 11553.01.XX.XX.ST9.XX.XX

SLIM LED TUBE 40 *1	REF.	DIMENSION	FINISH	OPTIC OPTIONS	POWER	CRI	K	LUMEN	WATT	VdC	DIMM	SKETCH
	11552	.01	●	.20 .40	.ST	.9	.27	954	14	48	.DA .D1	
							.30	991				
							.40	1067				

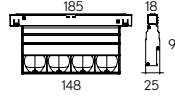
Reference order 11552.01.XX.XX.ST9.XX.XX

SLIM WALL WASHER *1	REF.	DIMENSION	FINISH	OPTIC OPTIONS	POWER	CRI	K	LUMEN	WATT	VdC	DIMM	SKETCH
	11550	.01	.BK-BK	-	.ST	.9	.27	882	15	48	.DA .D1	
							.30	1013				
							.40	1107				

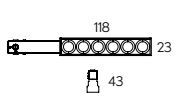
Reference order 11550.01.BK-BK.XX.ST9.XX.XX

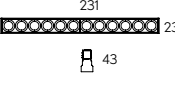
SLIM LENSES *1	REF.	DIMENSION	FINISH	OPTIC OPTIONS	POWER	CRI	K	LUMEN	WATT	VdC	DIMM	SKETCH
	11548	.06	.BK-BK	.15 .38	.ST	.9	.27	660	8	48	.DA .D1	
							.30	750				
							.40	827				
	11548	.12	.BK-BK	.15 .38	.ST	.9	.27	1320	15	48	.DA .D1	
							.30	1511				
							.40	1654				

Reference order 11548.XX.BK-BK.XX.ST9.XX.XX

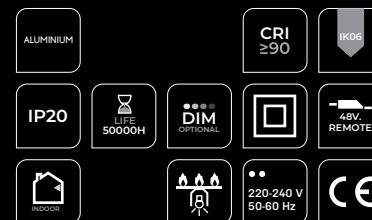

ALARIK SLIM ROUND

REF 210019.PN | 210019.SR

PHOTOMETRY

SLIM PATRICIA | SLIM PATRICIA ZOOM

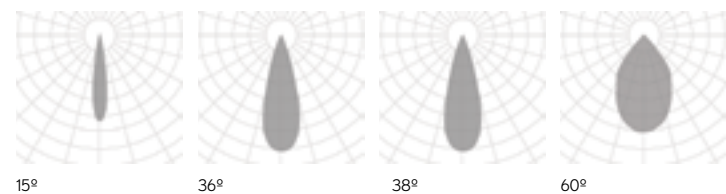

PHOTOMETRY

SLIM LED BALL SLIM WALL WASHER



PHOTOMETRY

SLIM TUBE

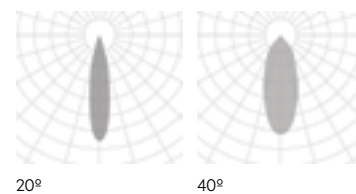

PHOTOMETRY

SLIM LENSES

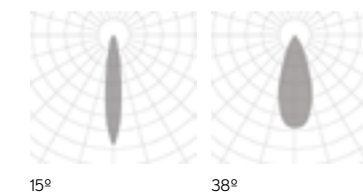



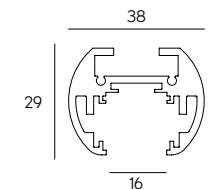

PROFILE

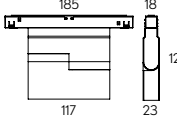

SR
PN
PENDANT | SURFACE

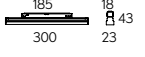
SLIM MOTION LENSES *1	REF.	DIMENSION	FINISH	OPTIC OPTIONS	POWER	CRI	K	LUMEN	WATT	VdC	DIMM	SKETCH
	11547	.01	.BK-BK	.15 .38	.ST	.9	.27	660	8	48	.DA .D1	
							.30	750				
							.40	827				

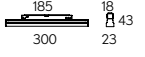
Reference order 11547.01.BK-BK.XX.ST9.XX.XX

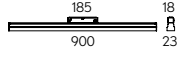
SLIM LED MODULES *1	REF.	DIMENSION	FINISH	DIFFUSER	POWER	CRI	K	LUMEN	WATT	VdC	DIMM	SKETCH
	11549	.01	.BK-BK	.OP	.ST	.9	.27	558	9	48	.DA .D1	
							.30	560				
							.40	604				
	11549	.02	.BK-BK	.OP	.ST	.9	.27	1115	18	48	.DA .D1	
							.30	1120				
							.40	1208				
	11549	.03	.BK-BK	.OP	.ST	.9	.27	1670	24	48	.DA .D1	
							.30	1680				
							.40	1812				

Reference order 11549.XX.BK-BK.XX.ST9.XX.XX

JOINTS & CONNECTORS

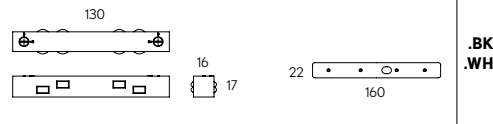
LINEAR JOINT	FINISH
	.BK-BK .WH-WH

UR19.XX

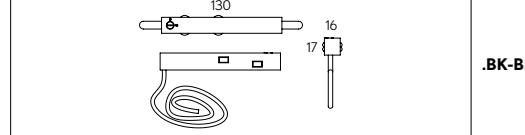
POWER FEEDER UNIT	FINISH
	.BK-BK

ACC210019.CA.XX

COMPONENTS

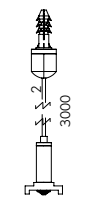
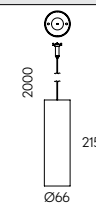
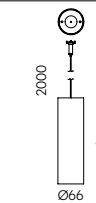
COVER KIT	REF.	FINISH	SUSPENSION KIT	REF.	SUSPENSION KIT WITH 48 TRANSFORMER BOX*2	REF.	SUSPENSION KIT WITH 48 TRANSFORMER BOX*3	REF.
	TF20	.SR .PN .XX		ACC210019.SC		ACC210019.PKDB		CB08.30

Reference order TF20.SR.PN.XX Reference order ACC210019.SC Reference order ACC210019.PKDB Reference order CB08.30

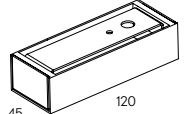
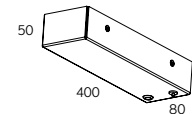
REMOTE 48V TRANSFORMER BOX	48V TRANSFORMER BOX	FINISH
		.SR .PN .XX
CB09.12	CB06.40	

Reference order XXXX.XX



PENDANT | SURFACE
SR
PN

ALUMINIUM

CRI ≥90

IP20

LIFE 50000H

DIM OPTIONAL

48V. REMOTE

RECORD

220-240 V 50-60 Hz

CE

Select finishes

WH-WH BK-BK

ALARIK

SLIM ROUND

REF 210019.PN | 210019.SR

PHOTOMETRY

SLIM MOTIONLENSES

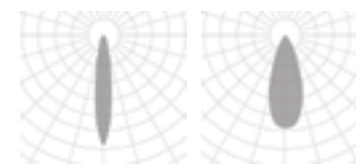

15°

38°

PHOTOMETRY

SLIM LED MODULES

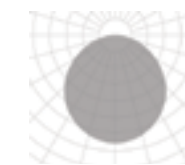

OPAL

*1 LED Modules are Class III. Los módulos LED son Clase III.
*2 Works with DR48 .01 and .03. Funciona con DR48 .01 y .03.
*3 Works with DR48 .02. Funciona con DR48 .02.



FINISHES

● COLORS



DIMENSIONS

● LENGTHS

PER METER

COMPONENTS

PATRICIA
LED MODULES
LENSES

POWER

STANDARD

CRI

90

COLOR TEMPERATURE

2700K | 3000K | 4000K

▼ DIMMABLE OPTIONS

DALI

▲ LIGHT DISTRIBUTION

DOWN

LUMINAIRE INCLUDES

.SR

Surface mounting kit



ON DEMAND
Profile Special RAL Color
Custom dimensions

INSTALLATIONS



.PN
PENDANT

·10225 ALARIK | PN
Pag. 190



.SR
SURFACE

·10225 ALARIK | SR
Pag. 190



.TR
TRIMLESS

·10225 ALARIK | TR
Pag. 628

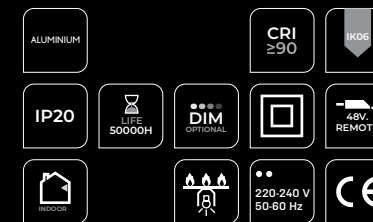

ALARIK

REF 10225.PN | 10225.SR

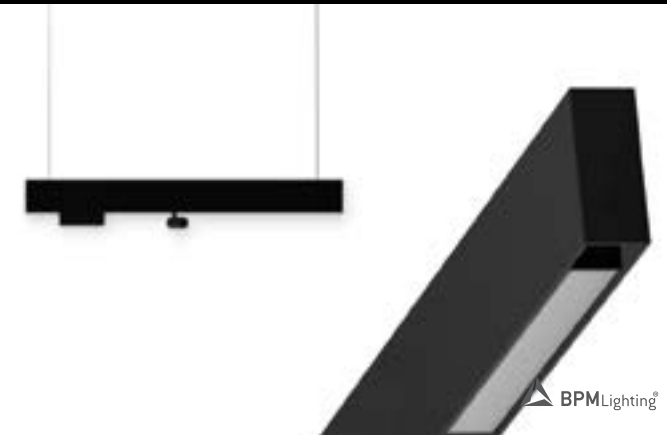
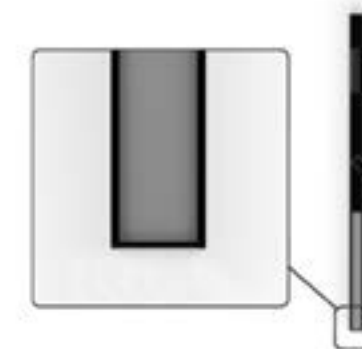

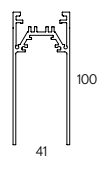
ALARIK	REF.	DIMENSION	FINISH	SKETCH
	10225	.01 1m	●	

Reference order | 10225.XX | .SR | .PN | .XX

48V TRANSFORMER	DIMENSION	WATT
DR48	.01	75
	.02	120
	.03	200

Reference order | DR48.XX

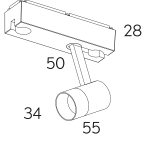
PATRICIA S *1	REF.	DIMENSION	FINISH	OPTIC OPTIONS	POWER	CRI	K	LUMEN	WATT	VdC	DIMM	SKETCH
	20146	.01	●	.15 .24 .38	.ST	.9	.27	421	8	48	.DA	
							.30	440				
							.40	465				

Reference order | 20146.01.XX.XX | .ST9.XX.XX

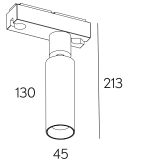
PATRICIA M *1	REF.	DIMENSION	FINISH	OPTIC OPTIONS	POWER	CRI	K	LUMEN	WATT	VdC	DIMM	SKETCH
	20193	.01	●	.15 .24 .38	.ST	.9	.27	544	13	48	.DA	
							.30	626				
							.40	706				



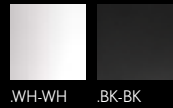

Reference order | 20193.01.XX.XX | .ST9.XX.XX

*1 LED Modules are Class III.
Los módulos LED son Clase III.

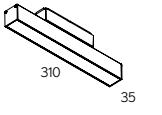

Select finishes

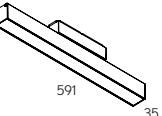

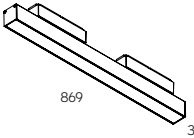
.WH-WH .BK-BK

LED MODULES *1	REF.	DIMENSION	FINISH	DIFFUSER	POWER	CRI	K	LUMEN	WATT	VdC	DIMM	SKETCH
	11542	.01	.BK-BK	.OP	.ST	.9	.27	306	6	48	.DA	
							.30	329				
							.40	352				
	11542	.02	.BK-BK	.OP	.ST	.9	.27	612	12	48	.DA	
							.30	657				
							.40	704				
	11542	.03	.BK-BK	.OP	.ST	.9	.27	955	18	48	.DA	
							.30	1031				
							.40	1081				

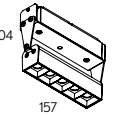
Reference order | 11542.XX.BK-BK.XX | .ST9.XX.XX

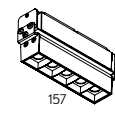
LENSES *1	REF.	DIMENSION	SHAPE	FINISH	OPTIC OP.	POWER	CRI	K	LUMEN	WATT	VdC	DIMM	SKETCH
	11534	.05F	.RD .SQ	.BK-BK	.20 .40 .60	.ST	.9	.27	660	10	48	.DA	
								.30	750				
								.40	827				
	11534	.05	.RD .SQ	.BK-BK	.20 .40 .60	.ST	.9	.27	660	10	48	.DA	
								.30	750				
								.40	827				



ROUND_RD
26x29.3 mm
Int Ø14.5 - Ext Ø23 mm



SQUARE_SQ
26x29.3 mm
Ø14.5 mm

Reference order | 11534.XX.XX.BK-BK.XX | .ST9.XX.XX

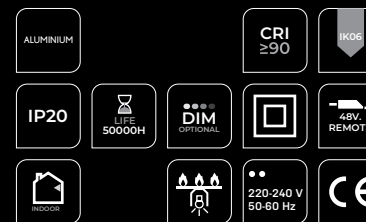

ALARIK

REF 10225.PN | 10225.SR

PHOTOMETRY

PATRICIA

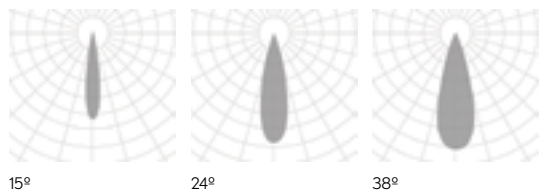

15° 24° 38°

PHOTOMETRY

LENSES

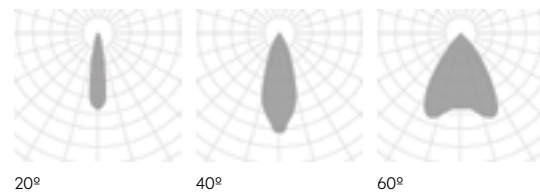

20° 40° 60°

PHOTOMETRY

LED MODULES



OPAL

PROFILE

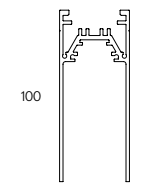

41

PENDANT | SURFACE

.SR

.PN

PENDANT | SURFACE

COMPONENTS

COVER KIT	REF.	FINISH
	TF18	●



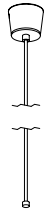

Reference order | TF18 | .SR | .PN | .XX

OPTIONS (.PN)

SUSPENSION KIT	REF.	DIMENSION	FINISH
	SC05	5M.	.SA
	SC07	7M.	
	SC10	10M.	

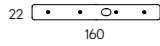
Reference order | SCXX.SA

JOINTS

LINEAR JOINT	ANGLE JOINT*2	T-JOINT	CROSS JOINT	WALL-CEILING JOINT	FINISH
 22 160				X	●
UR18	UL18	UT18	UC18	X	

Each angle joint requires an additional driver to that of the luminaire. *Cada esquina requiere de un driver adicional al de la luminaria.*
*2 Miter cut diffuser. *Difusor a inglete.*

Reference order | XX18 | .SR | .PN | .XX

BOXES (.PN) Not-included, please select:

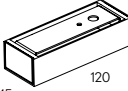
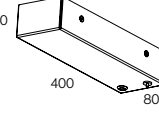
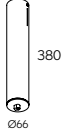
CONNECTION BOX FOR REMOTE DRIVER	DRIVER BOX		FINISH
 45 120	 50 400 80	 380 Ø66	●
CB09.12	CB06.40	CB08.30	

Reference order | XXXX.XX



PENDANT | SURFACE
SR
PN

● Select finishes



.WH-WH .BK-BK

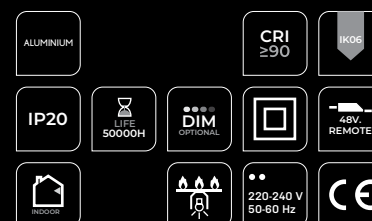

ALARIK

REF 10225.PN | 10225.SR

INCLUDED (.SR)

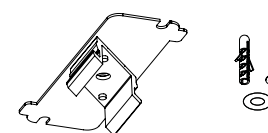

SR MOUNTING KIT

INCLUDED (.PN)

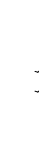

SC03.SA
WIRE 3M.

PROFILE

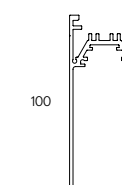

41



FINISHES

● COLORS



DIMENSIONS

● LENGTHS

PER METER

COMPONENTS

LED MODULES
LENSES
MINI TUBE
MINI TUBE STICK

POWER

STANDARD

CRI

90

COLOR TEMPERATURE

2700K | 3000K | 4000K

▼ DIMMABLE OPTIONS

DALI | 1.10 | PUSH

▲ LIGHT DISTRIBUTION

DOWN

LUMINAIRE INCLUDES

.PN

2 x Suspension cables 3m (each 2m)

NON-DIM DOWN: 1 x Feed Hose 3 x 0,75mm²

DIM DOWN or NON-DIM DOWN-UP: 1 x Feed Hose 5 x 0,75mm²

DIM DOWN-UP (only): 1 x Feed Hose 5 x 0,75mm²

.SR

Surface mounting kit



ON DEMAND

Special RAL Color
Special Shapes
Emergency Lighting*
Motion Detection
Custom dimensions
Special RAL Color
Tunable White
Up Light

* Delivered separately
(not installed in luminaire).

INSTALLATIONS



MODULIGHT

REF 10210.PN | 10210.SR



.PN
PENDANT

·10210 MODULIGHT | PN
Pag. 196



.SR
SURFACE

·10210 MODULIGHT | SR
Pag. 196



.RF
RECESSED FRAME

·10210 MODULIGHT | RF
Pag. 434



.TR
TRIMLESS

·10210 MODULIGHT | TR
Pag. 634

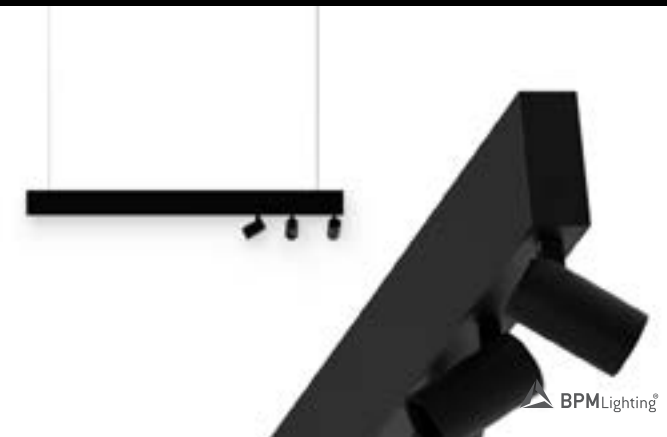
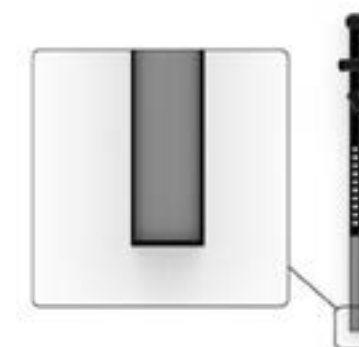

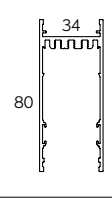
MODULIGHT	REF.	DIMENSION	FINISH	SKETCH
	10210	.01 1m	●	

Reference order | 10210.XX | .SR | .PN | .XX

DRIVER	DIMENSION*1	DIMM
DR10210	.01 0 - 15 W	.DA .PU .D1
	.02 16 - 30 W	
	.03 31 - 65 W	
	.04 66 - 90 W	

Reference order | DR10210.XX.XX

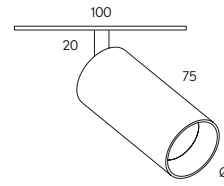
MINI TUBE	REF.	DIMENSION	FINISH	OPTIC OPTIONS	POWER	CRI	K	LUMEN	WATT	mA	SKETCH
 90° 350°	11526	.01	.BK-BK .WH-WH	.15 .24 .38	.ST	.9	.27	432	8	700	
							.30	445			
							.40	492			

Reference order | 11526.01.XX.XX.ST9.XX

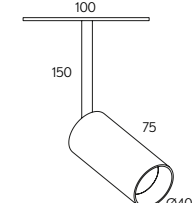
MINI TUBE STICK	REF.	DIMENSION	FINISH	OPTIC OPTIONS	POWER	CRI	K	LUMEN	WATT	mA	SKETCH
 90° 350°	11538	.01	.BK-BK .WH-WH	.15 .24 .38	.ST	.9	.27	432	8	700	
							.30	445			
							.40	492			





Reference order | 11538.01.XX.XX.ST9.XX

 Modular system that requires a technical drawing

*1 Driver power must be at least 15% higher than the sum of the power of selected LED modules. *La potencia del driver deber ser por lo menos un 15% mayor que la suma de la potencia de los modulos LED elegidos.*

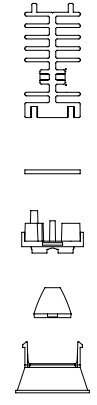
• Select lens finishes



LENSES	REF.	DIMENSIONS	SHAPE	FINISH	OPTIC OPTIONS	POWER	CRI	K	LUMEN	WATT	mA	SKETCH
	11525	.01 29mm.	.RD .SQ	●	.20 .40 .60	.ST	.9	.27	161	2	700	
								.30	169			
								.40	176			
	11525	.03 80mm.	.RD .SQ	●	.20 .40 .60	.ST	.9	.27	483	6	700	
								.30	507			
								.40	528			
	11525	.05 133mm.	.RD .SQ	●	.20 .40 .60	.ST	.9	.27	805	10	700	
								.30	845			
								.40	880			
	11525	.10 263mm.	.RD .SQ	●	.20 .40 .60	.ST	.9	.27	1603	20	700	
								.30	1690			
								.40	1760			

Reference order | 11525.XX.XX.XX.XX.ST9.XX

COVERT	REF.	FINISH
	ACC10210.01	●

Reference order | ACC10210.01.XX

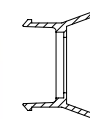
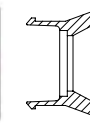

MODULIGHT

REF 10210.PN | 10210.SR

PHOTOMETRY

MINI TUBE

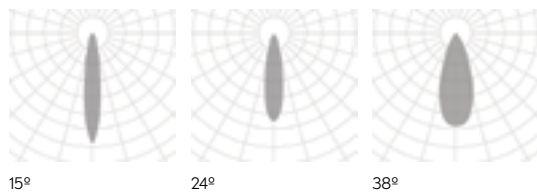

PHOTOMETRY

MINI LENSES

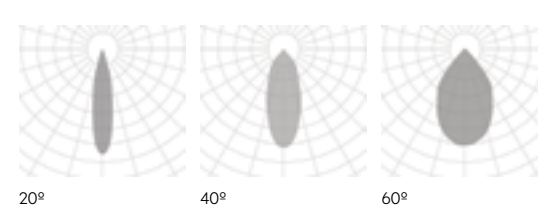

INCLUDED (.PN)

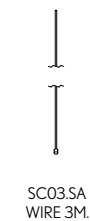

PROFILE

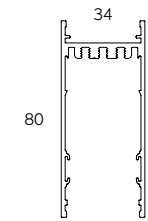

LED MODULES	REF.	DIMENSION ▲	DIFFUSER ■	POWER	CRI	K	LUMEN	WATT	mA	SKETCH
	11524	.01 281mm.	.OP .MP	.HI	.9	.27	1120	12	700	
						.30	1173			
						.40	1125			
	11524	.02 562mm.	.OP .MP	.HI	.9	.27	2240	24	700	
						.30	2346			
						.40	3375			
	11524	.03 843mm.	.OP .MP	.HI	.9	.27	3360	36	700	
						.30	3519			
						.40	3375			
	11524	.04 1124mm.	.OP .MP	.HI	.9	.27	4480	48	700	
						.30	4692			
						.40	4500			
	11524	.05 1405mm.	.OP .MP	.HI	.9	.27	5600	60	700	
						.30	5865			
						.40	5625			
	11524	.06 1686mm.	.OP .MP	.HI	.9	.27	6720	72	700	
						.30	7038			
						.40	6750			

Reference order | **11524.XX.XX.HI.9.XX**

COMPONENTS

COVER KIT	REF.	FINISH
	TF23 2x3mm.	●

Reference order | TF23.SR.PN.XX

BOXES (.PN) Not-included please select:

CONNECTION BOX
CB09.12

Reference order | CB09.12.XX

JOINTS

LINEAR JOINT	ANGLE JOINT *2	T-JOINT	CROSS JOINT	WALL-CEILING JOINT	FINISH
		X	X		●
UR23	UL23	X	X	UV23	

Reference order | XX23.SR.PN.XX

*2 Miter cut diffuser. Difusor a inglete.

• Select finishes

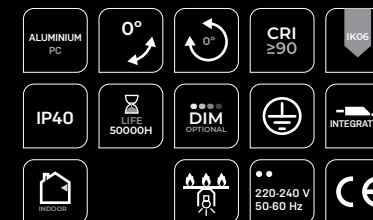

MODULIGHT

REF 10210.PN | 10210.SR

PHOTOMETRY

LED MODULES

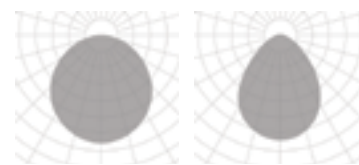

OPAL

MICROPRISMATIC

INCLUDED (.PN)

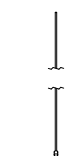

SC03.SA
WIRE 3M.

PROFILE

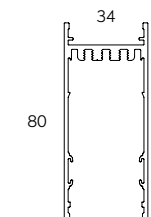



FINISHES

● COLORS



DIMENSIONS

◆ ELECTRIC SYSTEM LENGTH mm.

800 | 1100 | 1400 | 1700 | 2000 | 2300

LIGHTING OPTIONS

■ DIFFUSERS

OPAL

POWER

STANDARD

CRI

90

COLOR TEMPERATURE

2700K | 3000K | 4000K

▼ DIMMABLE OPTIONS

DALI | 1.10 | PUSH

▲ LIGHT DISTRIBUTION

DOWN | UP-DOWN

LUMINAIRE INCLUDES

.PN

2 x Suspension cables 3m
 NON-DIM DOWN | DIM DOWN
 NON-DIM UP-DOWN | DIM UP-DOWN: Cabling 1 circuit 1 x Feed
 Hose 3 x 0,75mm²

.SR

Surface mounting kit



new



ON DEMAND

Special RAL Color
 RGB
 TW*2
 Number switches



INSTALLATIONS

.PN
 PENDANT

·210007 OKKIA|PN
 Pag. 202

.SR
 SURFACE

·210007 OKKIA|SR
 Pag. 202

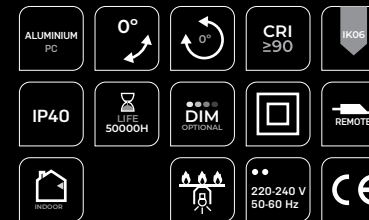

OKKIA

REF 210007.PN | 210007.SR

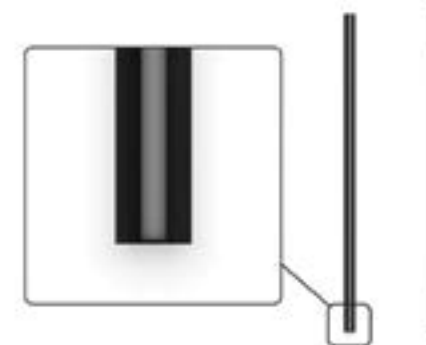

REF.	ELECTRIC SYSTEM LENGTH		FINISH	DIFFUSER	POWER	CRI	DOWNLIGHT LUMEN			WATT K	UPLIGHT ▲ UP *1 LUMEN			WATT K	DIMM ▼
	MM	MM					.27	.30	.40		.27	.30	.40		
210007	.03	800	●	.OP	.ST	.9	2480	2560	2640	23	676	690	725	7	.DA .PU .D1
	.04	1100					3410	3520	3630	31	1117	1140	1197	11	
	.05	1400					4340	4480	4620	39	1558	1590	1670	16	
	.06	1700					5270	5440	5610	48	1990	2040	2142	20	
	.07	2000					6200	6400	6600	56	2440	2492	2615	25	
	.08	2300					7130	7360	7590	64	2881	2940	3087	29	

Reference order | 210007.XX | .SR | .PN | .XX.XX | .ST9.XX.XX.XX

COMPONENTS

COVER KIT	REF.	FINISH
	TF11 2x2mm.	●

Reference order | TF11 | .SR | .PN | .XX

BOXES (.PN) Not-included, please select:

CONNECTION BOX	DRIVER BOX NON-DIMM	DRIVER BOX DIMMABLE	FINISH
			●
CB09.12	CB06.32	CB06.40	

Reference order | CB09.XX.XX

OPTIONS (.PN)

SUSPENSION KIT	REF.	DIMEN-SION	FINISH
	SC05	5M.	.SA
	SC07	7M.	
	SC10	10M.	

Reference order | SCXX.SA

SUSPENSION ROD	REF.	DIMEN-SIONS	mm	FINISH
	SC21	.60	600	●
		.80	800	
		.100	1000	

Reference order | SC21.XX.XX

Total length = Electric System Length + 20mm + 2x2mm (Cover kit)

Select finishes



OKKIA

REF 210007.PN | 210007.SR

PHOTOMETRY

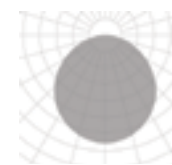

OPAL

INCLUDED (.PN)

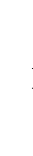

SC03.SA
WIRE 3M.

PROFILE

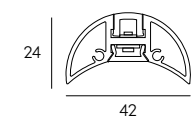

*1 Uplight (UP) is only available for ON-OFF and DALI dimmable (.DA) options, both in 24VdC. - UP luminaires carry the same color temperature above and below (up-down).
La luz indirecta está solo disponible para versiones on-off y regulación DALI (.DA), ambas en 24VdC. - Las luminarias UP llevan la misma temperatura de color arriba y abajo (arriba-abajo).
*2 TWUP luminaires have 3000K indirect light by default, for other options, please check with sales team. Las luminarias TWUP tienen luz indirecta de 3000K, para otras opciones, consultar con el equipo comercial.



FINISHES

EXTERNAL COLOR



INTERNAL COLOR



DIMENSIONS

ELECTRIC SYSTEM LENGTH mm.

800 | 1100 | 1400 | 1700 | 2000 | 2300

LIGHTING OPTIONS

DIFFUSERS

OPAL

POWER

STANDARD

CRI

90

COLOR TEMPERATURE

2700K | 3000K | 4000K

DIMMABLE OPTIONS

DALI | 1.10 | PUSH

LIGHT DISTRIBUTION

DOWN | UP-DOWN

LUMINAIRE INCLUDES

2 x Suspension cables 3m
 NON-DIM DOWN | DIM DOWN
 NON-DIM UP-DOWN | DIM UP-DOWN: Cabling 1 circuit 1 x Feed Hose
 3 x 0,75mm²

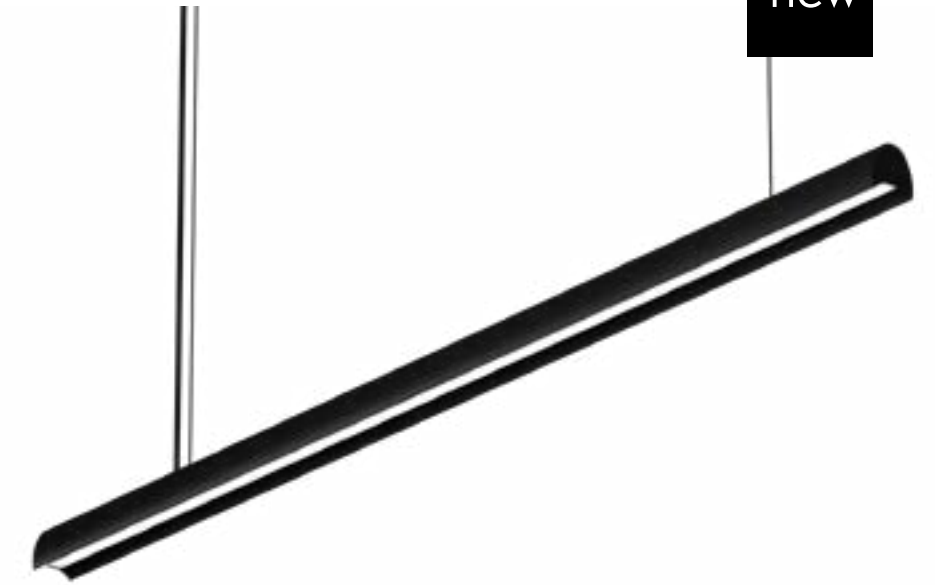

ON DEMAND

Special RAL Color
 RGB
 TW*2



INSTALLATIONS



.PN
 PENDANT

210017 OKKIA PLUS | PN
 Pag. 206

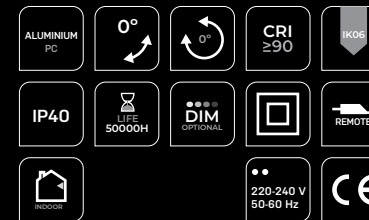

OKKIA PLUS

REF 210017.PN

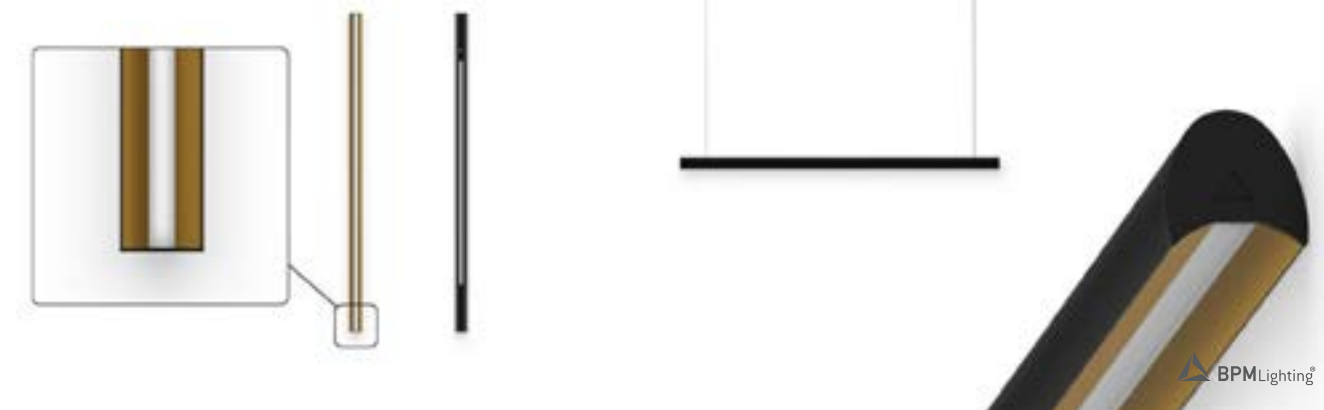

REF.	ELECTRIC SYSTEM LENGTH		FINISH	DIFFUSER	POWER	CRI	DOWNLIGHT LUMEN			WATT K	UPLIGHT ▲ UP *1 LUMEN			WATT K	DIMM ▼
	MM	MM					.27	.30	.40		.27	.30	.40		
210017	.03	800	●	.OP	.ST	9	2480	2560	2640	23	676	690	725	7	.DA .PU .D1
	.04	1100					3410	3520	3630	31	1117	1140	1197	11	
	.05	1400					4340	4480	4620	39	1558	1590	1670	16	
	.06	1700					5270	5440	5610	48	1990	2040	2142	20	
	.07	2000					6200	6400	6600	56	2440	2492	2615	25	
	.08	2300					7130	7360	7590	64	2881	2940	3087	29	

Reference order | 210017.XX | .SR | .PN | .XX.XX | .ST.9.XX.XX.XX

COMPONENTS

COVER KIT	REF.	FINISH
	TF12 2x2mm.	●

Reference order | TF12.PN.XX

BOXES (.PN) Not-included, please select:

CONNECTION BOX	DRIVER BOX NON-DIMM	DRIVER BOX DIMMABLE	FINISH
			●
CB09.12	CB09.32	CB09.40	

Reference order | CBXXXX.XX

OPTIONS

SUSPENSION KIT	REF.	DIMENSION	FINISH
	SC05	5M.	.SA
	SC07	7M.	
	SC10	10M.	

Reference order | SCXX.SA

Total length = Electric System Length + 20mm + 2x2mm (Cover kit)

Select finishes



OKKIA PLUS

REF 210017.PN

PHOTOMETRY

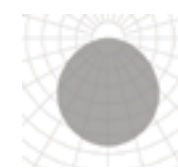

OPAL

INCLUDED



SC03.SA
WIRE 3M.

PROFILE

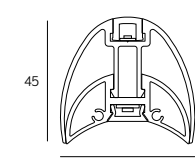

45

*1 Uplight (UP) is only available for ON-OFF and DALI dimmable (.DA) options, both in 24VdC. - UP luminaires carry the same color temperature above and below (up-down).
La luz indirecta está solo disponible para versiones on-off y regulación DALI (.DA), ambas en 24VdC. - Las luminarias UP llevan la misma temperatura de color arriba y abajo (arriba-abajo).
*2 TWUP luminaires have 3000K indirect light by default, for other options, please check with sales team. Las luminarias TWUP tienen luz indirecta de 3000K, para otras opciones, consultar con el equipo comercial.



FINISHES

● COLORS



DIMENSIONS

◆ ELECTRIC SYSTEM LENGTH mm.

843 | 1124 | 1405 | 1686 | 1967 | 2248

LIGHTING OPTIONS

■ DIFFUSERS

OPAL | MICROPRISMATIC

POWER

STANDARD | HIGH

CRI

90

COLOR TEMPERATURE

2700K | 3000K | 4000K | TW

▼ DIMMABLE OPTIONS

DALI | 1.10 | PUSH

▲ LIGHT DISTRIBUTION

DOWN | UP-DOWN

LUMINAIRE INCLUDES

.PN

2 x Suspension cables 3m (each 2m)
 NON-DIM DOWN or DIM DOWN: 1 x Feed Hose 3 x 0,75mm²
 NON-DIM DOWN-UP or DIM DOWN-UP (only): 1 x Feed
 Hose 5 x 0,75mm²
 Diffuser

.SR

Surface mounting kit

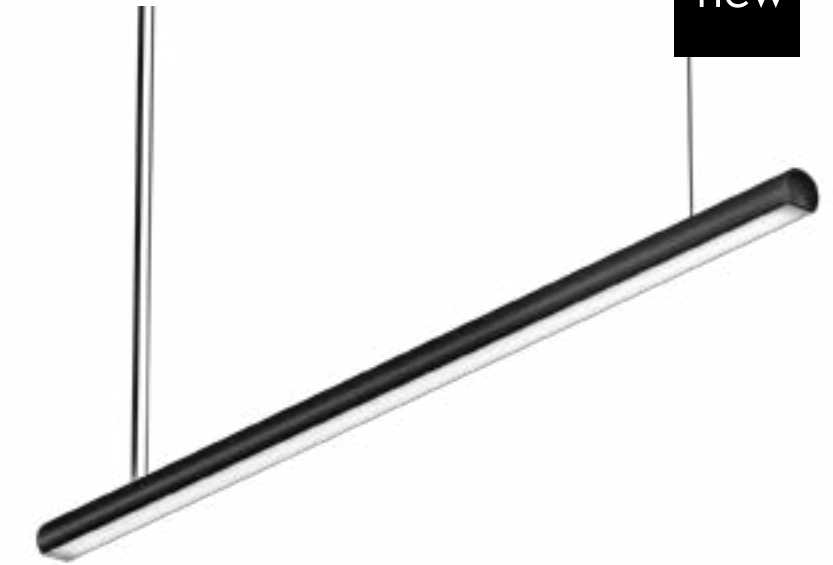

ON DEMAND

Special RAL Color
 Emergency Lighting *
 Motion Detection
 Custom dimensions
 Special Color Temperature
 RGB
 Thematic LED
 Wireless Control Options (Casambi)
 CRI 80

* Delivered separately
 (not installed in luminaire).



INSTALLATIONS

.PN
 PENDANT

·210003 LINGGO MINI | PN
 Pag. 210

.SR
 SURFACE

·210003 LINGGO MINI | SR
 Pag. 210



LINGGO MINI

REF 210003.PN | 210003.SR



PENDANT | SURFACE

new

.SR

.PN

PENDANT | SURFACE

211



new

FINISHES

● COLORS



DIMENSIONS

◆ ELECTRIC SYSTEM LENGTH mm.

843 | 1124 | 1405 | 1686 | 1967 | 2248

LIGHTING OPTIONS

■ DIFFUSERS

OPAL

POWER

STANDARD | HIGH

CRI

90

COLOR TEMPERATURE

2700K | 3000K | 4000K | TW

▼ DIMMABLE OPTIONS

DALI | 1.10 | PUSH

▲ LIGHT DISTRIBUTION

DOWN | UP-DOWN

LUMINAIRE INCLUDES

.PN

1 Switch
2 x Suspension cables 3m
NON-DIM: 1 x Feed Hose 3 x 0,75mm²
DIM: 1 x Feed Hose 5 x 0,75mm²

.SR

Surface mounting kit

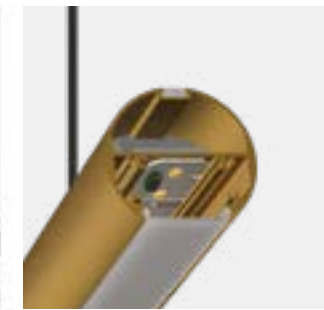
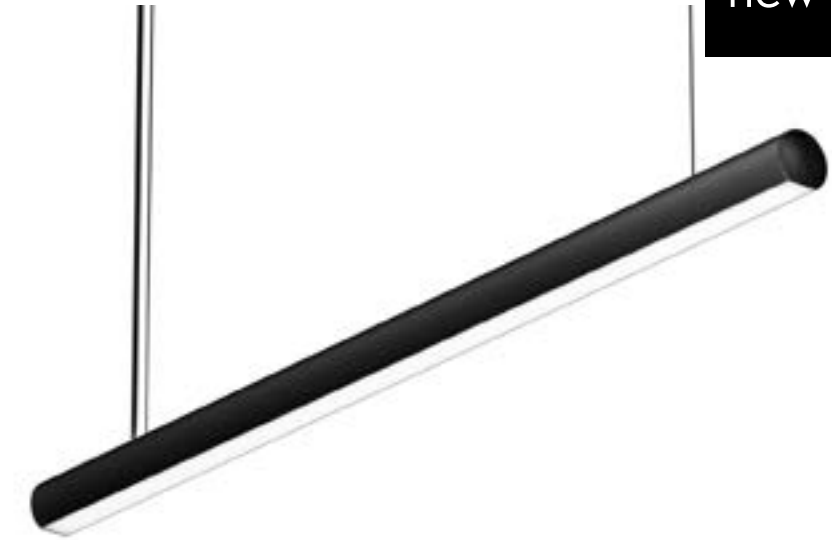

ON DEMAND

Special RAL Color
Emergency Lighting*
Motion Detection
Custom dimensions
Special Color Temperature
RGB
Thematic LED
Wireless Control Options (Casambi)
CRI 80

* Delivered separately
(not installed in luminaire).

INSTALLATIONS



.PN
PENDANT

·210002 LINGGO | PN
Pag. 214

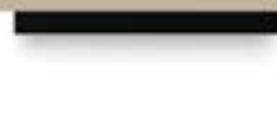

.SR
SURFACE

·210002 LINGGO | SR
Pag. 214



LINGGO

REF 210002.PN | 210002.SR

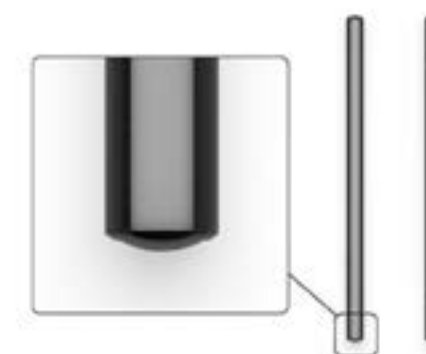

PENDANT | SURFACE

REF.	ELECTRIC SYSTEM LENGTH		FINISH	DIFFUSER	POWER	CRI	DOWNLIGHT *4				WATT		UPLIGHT ▲.UP *3 LUMEN			WATT		DIMM OP.
	MM	MM					.27	.30	.40	.TW *2	K	TW	.27	.30	.40	K	K	
210002	.03	843	●	.OP	.ST	.9	2295	2385	2475	5700-5910	18	38	397	405	425	4	.DA*1 .PU .D1	
	.04	1124					3060	3180	3300	7600-7880	24	51	622	634	666	6		
	.05	1405					3825	3975	4125	9500-9850	30	64	824	840	882	8		
	.06	1686					4590	4770	4950	11400-11820	36	76	1034	1054	1107	10		
	.07	1967					5355	5565	5775	13300-13790	42	89	1243	1268	1331	12		
	.08	2248					6120	6360	6600	15200-15760	48	102	1460	1490	1564	14		

REF.	ELECTRIC SYSTEM LENGTH		FINISH	DIFFUSER	POWER	CRI	DOWNLIGHT *4 LUMEN			UPLIGHT ▲.UP *3 LUMEN			WATT		DIMM OP.
	MM	MM					.27	.30	.40	.27	.30	.40	K	TW	
210002	.03	843	●	.OP	.HI	.9	4590	4767	4956	36	643	683	722	8	.DA*1 .PU .D1
	.04	1124					6120	6356	6608	48	1007	1069	1131	12	
	.05	1405					7650	7945	8260	60	1334	1417	1500	16	
	.06	1686					9180	9534	9912	72	1674	1777	1881	20	
	.07	1967					10710	11123	11564	84	2014	2138	2263	24	
	.08	2248					12240	12712	13216	96	2366	2512	2658	28	

Reference order | 210002.XX | .SR | .PN | .XX.XX.XX.9.XX.XX.XX

Total length = Electric System Length + 20mm + 2x12mm (Cover kit)

● Select finishes



COMPONENTS

COVER KIT	REF.	FINISH
	TF09 2x12mm.	●

Reference order | TF09 | .SR | .PN | .XX

REDUGER	REF.	POWER
	ACC.RG	.ST .HI

Reference order | ACC.RG.XX

JOINTS

LINEAR JOINT	ANGLE JOINT*5	T-JOINT	CROSS JOINT	WALL-CEILING JOINT	FINISH
		X	X	X	●
UR09	UL09	X	X	X	

Reference order | UL09 | .SR | .PN | .XX

OPTIONS (.PN)

SUSPENSION KIT	REF.	DIMENSION	FINISH
	SC05	5M.	.SA
	SC07	7M.	
	SC10	10M.	

Reference order | SCXX.SA

SUSPENSION ROD	REF.	DIMENSIONS	mm	FINISH
	SC21	.60	600	●
		.80	800	
		.100	1000	

Reference order | SC21.XX.XX

Not-included, please select:

CONNECTION BOX	FINISH
	●
CB09.12	

Reference order | CB09.12.XX

LINGGO

REF 210002.PN | 210002.SR

PHOTOMETRY

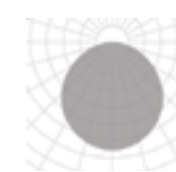

OPAL

INCLUDED (.PN)



SC03.SA
WIRE 3M.

PROFILE

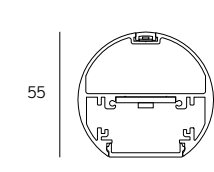

61

*1 DALI protocol requires remote driver. *Protocolo DALI requiere driver en remoto.*
 *2 Tunable White (TW) values correspond to 2700K and 6500K - TW is only available for DALI DT8 dimmable (DA), CRI 80 (8) 700mA. *Los valores del blanco dinámico (TW) corresponden a 2700K y 6500K. -TW solo está disponible con protocolo DALI DT8 (DA), CRI 80 (8) 700mA.*
 *3 Uplight (UP) is only available for ON-OFF and DALI dimmable (DA) options, both in 24VdC. - U.P luminaires carry the same color temperature above and below (up-down). *La luz indirecta está solo disponible para versiones on-off y regulación DALI (DA), ambas en 24VdC. - Las luminarias U.P llevan la misma temperatura de color arriba y abajo (arriba-abajo).*
 *4 Down light (direct light) works at 500mA. *La luz directa trabaja a 500mA.*
 *5 Miter cut diffuser. *Difusor a inglete.*



FINISHES

● COLORS



DIMENSIONS

● ELECTRIC SYSTEM LENGTH mm.

843 | 1124 | 1405 | 1686 | 1967 | 2248

LIGHTING OPTIONS

■ DIFFUSERS

OPAL

POWER

STANDARD

CRI

90

COLOR TEMPERATURE

2700K | 3000K | 4000K

▼ DIMMABLE OPTIONS

DALI | 1.10 | PUSH

▲ LIGHT DISTRIBUTION

DOWN

LUMINAIRE INCLUDES

.PN

1 Switch
2 x Suspension cables 3m
NON-DIM: 1 x Feed Hose 3 x 0,75mm²
DIM: 1 x Feed Hose 5 x 0,75mm².

.SR

Surface mounting kit



new



ON DEMAND

Special RAL Color
Emergency Lighting *
Special Color Temperature
RGB
Thematic LED
Wireless Control Options (Casambi)
CRI 80

* Delivered separately
(not installed in luminaire).



INSTALLATIONS

.PN
PENDANT

·210010 BUBBLE | PN
Pag. 218

.SR
SURFACE

·210010 BUBBLE | SR
Pag. 218



BUBBLE

REF 210010.PN | 210010.SR

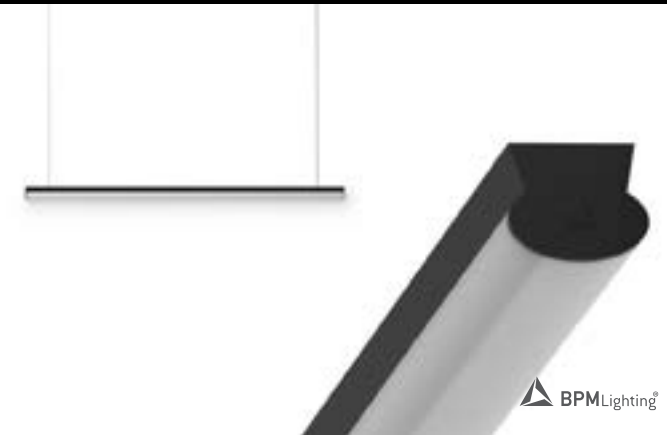
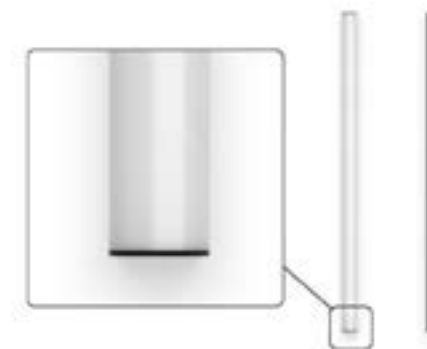

.SR

.PN

PENDANT | SURFACE

REF.	ELECTRIC SYSTEM LENGTH		FINISH	DIFFUSER	POWER	CRI	DOWNLIGHT *1 LUMEN			WATT K	DIMM ▼
	●	MM					.27	.30	.40		
210010	.03	843	●	.OP	.ST	.9	2295	2385	2475	18	.DA .PU .D1
	.04	1124					3060	3180	3300	24	
	.05	1405					3825	3975	4125	30	
	.06	1686					4590	4770	4950	36	
	.07	1967					5355	5565	5775	42	
	.08	2248					6120	6360	6600	48	

Reference order | 210010.XX | .SR | .PN | .XX.XX | .ST9.XX.XX

COMPONENTS

COVER KIT	REF.	FINISH
	TF15 2x3mm.	●

Reference order | TF15 | .SR | .PN | .XX

BOXES (.PN) Not-included, please select:

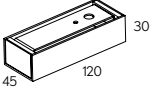
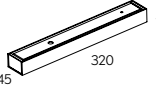
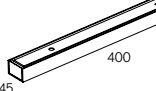
CONNECTION BOX	DRIVER BOX NON-DIMM	DRIVER BOX DIMMABLE	FINISH
			●
CB09.12	CB09.32	CB09.40	

Reference order | CBXXXX.XX

JOINTS

LINEAR JOINT

UR15

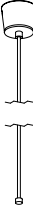

OPTIONS (.PN)

SUSPENSION KIT	REF.	DIMEN- SION	FINISH
	SC05	5M.	.SA
	SC07	7M.	
	SC10	10M.	

Reference order | SCXX.SA

Total length = Electric System Length + 20mm + 2x3mm (Cover kit)

• Select finishes



BUBBLE

REF 210010.PN | 210010.SR

PHOTOMETRY

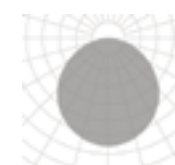

OPAL

INCLUDED (.PN)



SC03.SA
WIRE 3M.

PROFILE

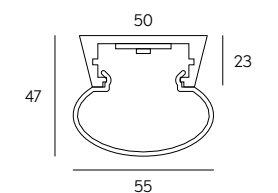

*1 Down light (direct light) works at 500mA. La luz directa trabaja a 500mA.



new

FINISHES

● COLORS



DIMENSIONS

◆ ELECTRIC SYSTEM LENGTH mm.

843 | 1124 | 1405 | 1686 | 1967 | 2248

LIGHTING OPTIONS

■ DIFFUSERS

OPAL

POWER

STANDARD

CRI

90

COLOR TEMPERATURE

2700K | 3000K | 4000K | TW

▼ DIMMABLE OPTIONS

DALI | 1.10 | PUSH

▲ LIGHT DISTRIBUTION

DOWN

LUMINAIRE INCLUDES

Surface mounting kit

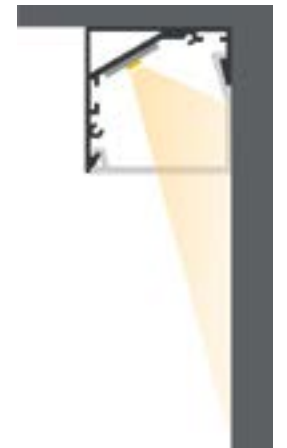

ON DEMAND

Special RAL Color
Emergency Lighting*
Motion Detection
Custom dimensions
Special Color Temperature
RGB
Thematic LED
Wireless Control Options (Casambi)
CRI 80



* Delivered separately
(not installed in luminaire).

.SR

SURFACE

INSTALLATIONS



EDGE

REF 210014.SR

.SR
SURFACE

·210014 EDGE | SR
Pag. 222

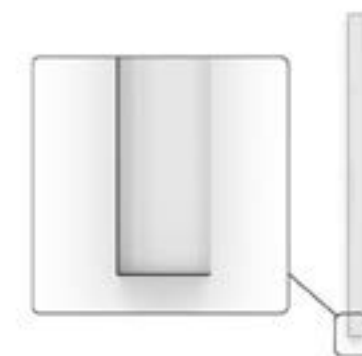

REF.	ELECTRIC SYSTEM LENGTH		FINISH	DIFFUSER	POWER	CRI	DOWNLIGHT LUMEN				WATT		DIMM
	MM	MM					.27	.30	.40	.TW	K	TW	
210014	.03	843	●	.OP	.ST	.9	2295	2385	2475	5700-5910	18	38	.DA .PU .D1
	.04	1124					3060	3180	3300	7600-7880	24	51	
	.05	1405					3825	3975	4125	9500-9850	30	64	
	.06	1686					4590	4770	4950	11400-11820	36	76	
	.07	1967					5355	5565	5775	13300-13790	42	89	
	.08	2248					6120	6360	6600	15200-15760	48	102	

Reference order | 210014.XX.SR.XX.XX.XX.9.XX.XX



Total length = Electric System Length + 20mm + 2x2mm (Cover kit)

COMPONENTS

COVER KIT	REF.	FINISH
	TF08 2x2mm.	●

Reference order | TF08.SR.XX

JOINTS

LINEAR JOINT
UR08

Select finishes

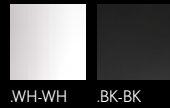

- ALUMINUM PC
- 0°
- 0°
- CRI ≥90
- IK05
- IP40
- LIFE 50000H
- DIM OPTIONAL
- REMOTE
- RECOOL
- 220-240 V 50-60 Hz
- CE

EDGE

REF 210014.SR

PHOTOMETRY

INCLUDED



SR INSTALLATION KIT

PROFILE

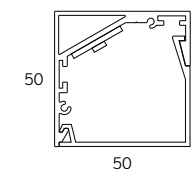

SURFACE



FINISHES

● COLORS



DIMENSIONS

◆ ELECTRIC SYSTEM LENGTH mm.

843 | 1124 | 1405 | 1686 | 1967 | 2248

LIGHTING OPTIONS

■ DIFFUSERS

OPAL | MICROPRISMATIC

POWER

STANDARD | HIGH

CRI

90

COLOR TEMPERATURE

2700K | 3000K | 4000K | TW

▼ DIMMABLE OPTIONS

DALI | 1.10 | PUSH

▲ LIGHT DISTRIBUTION

DOWN | UP-DOWN

LUMINAIRE INCLUDES

.PN

2 x Suspension cables 3m (each 2m)
 NON-DIM DOWN or DIM DOWN: 1 x Feed Hose 3 x 0,75mm²
 NON-DIM DOWN-UP or DIM DOWN-UP: 1 x Feed Hose 5 x 0,75mm²
 Diffuser

.SR

Surface mounting kit



ON DEMAND

Special RAL Color
 Emergency Lighting*
 Motion Detection
 Custom dimensions
 Special Color Temperature
 RGB
 Thematic LED
 Wireless Control Options (Casambi)
 CRI 80



* Delivered separately
 (not installed in luminaire).

INSTALLATIONS

.PN
 PENDANT

·10211 ALBA MINI | PN
 Pag. 226

.SR
 SURFACE

·10211 ALBA MINI | SR
 Pag. 226

.RF
 RECESSED FRAME

·10211 ALBA MINI | RF
 Pag. 440

.TR
 TRIMLESS

·10211 ALBA MINI | TR
 Pag. 640



ALBA MINI

REF 10211.PN | 10211.SR

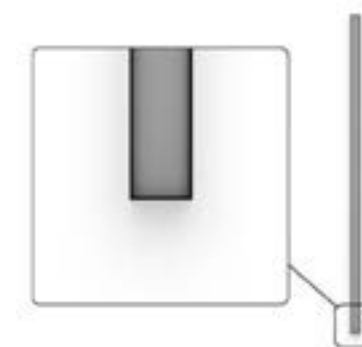

REF.	ELECTRIC SYSTEM LENGTH		FINISH	DIFFUSER	POWER	CRI	DOWNLIGHT *3 LUMEN				WATT		UPLIGHT ▲.UP *2 LUMEN			WATT		DIMM
	MM	MM					.27	.30	.40	.TW *1	K	TW	.27	.30	.40	K		
10211	.03	843	●	.OP .MP	.ST	.9	2295	2385	2475	5700-5910	18	38	397	405	425	4	.DA .PU .D1	
	.04	1124					3060	3180	3300	7600-7880	24	51	622	634	666	6		
	.05	1405					3825	3975	4125	9500-9850	30	64	824	840	882	8		
	.06	1686					4590	4770	4950	11400-11820	36	76	1034	1054	1107	10		
	.07	1967					5355	5565	5775	13300-13790	42	89	1243	1268	1331	12		
	.08	2248					6120	6360	6600	15200-15760	48	102	1460	1490	1564	14		

REF.	ELECTRIC SYSTEM LENGTH		FINISH	DIFFUSER	POWER	CRI	DOWNLIGHT *3 LUMEN			UPLIGHT ▲.UP *2 LUMEN			WATT		DIMM	
	MM	MM					.27	.30	.40	.27	.30	.40	K			
10211	.03	843	●	.OP .MP	.HI	.9	4590	4767	4956	36		643	683	722	8	.DA .PU .D1
	.04	1124					6120	6356	6608	48		1007	1069	1131	12	
	.05	1405					7650	7945	8260	60		1334	1417	1500	16	
	.06	1686					9180	9534	9912	72		1674	1777	1881	20	
	.07	1967					10710	11123	11564	84		2014	2138	2263	24	
	.08	2248					12240	12712	13216	96		2366	2512	2658	28	

Reference order | 10211.XX | .SR | .PN | .XX.XX.XX.9.XX.XX.XX

Total length = Electric System Length + 25mm + 2x2mm (Cover kit)

Linear Joint Total length = Profile length + 25mm + [2x2mm (Cover kit)] + [Nº of UR03 x 8]

Joints, other than Linear joint, require a technical drawing

● Select finishes

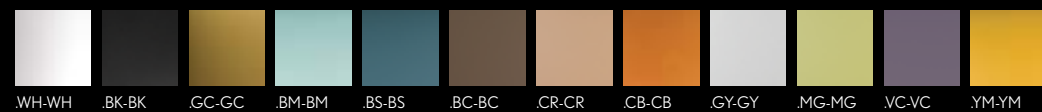

COMPONENTS

COVER KIT	REF.	FINISH
	TF03	2x2mm.

Reference order | TF03 | .SR | .PN | .XX

BOXES (.PN) Not-included, please select:

CONNECTION BOX	DRIVER BOX NON-DIMM	DRIVER BOX DIMMABLE	FINISH
			●
CB09.12	CB09.32	CB09.40	

Reference order | CB09.XX.XX

JOINTS

LINEAR JOINT	ANGLE JOINT*4	T-JOINT	CROSS JOINT	WALL-CEILING JOINT	FINISH
					●
UR03	UL03	UT03	UC03	UV03	

Reference order | XX03 | .SR | .PN | .XX

OPTIONS (.PN)

SUSPENSION KIT	REF.	DIMENSION	FINISH
	SC05	5M.	.SA
	SC07	7M.	
	SC10	10M.	

Reference order | SCXX.SA

SUSPENSION ROD	REF.	DIMENSIONS	mm	FINISH
	SC21	.60	600	●
		.80	800	
		.100	1000	

Reference order | SC21.XX.XX

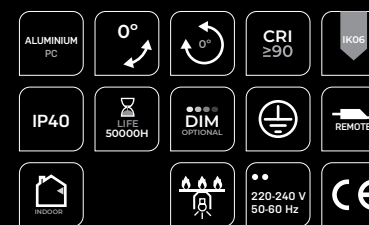

ALBA MINI

REF 10211.PN | 10211.SR

PHOTOMETRY

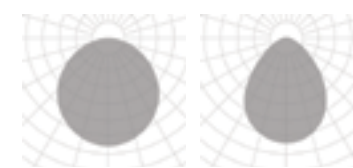

OPAL MICROPRISMATIC

INCLUDED (.PN)



SC03.SA WIRE 3M.

PROFILE

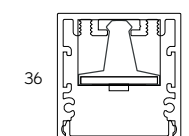

36 34

*1 Tunable White (TW) values correspond to 2700K and 6500K - TW is only available for DALI DT8 dimmable (DA), CRI 80 (8) 700mA. Los valores del blanco dinámico (TW) corresponden a 2700K y 6500K. -TW solo está disponible con protocolo DALI DT8 (DA), CRI 80 (8) 700mA.

*2 Uplight (UP) is only available for ON-OFF and DALI dimmable (DA) options, both in 24VdC. - UP luminaires carry the same color temperature above and below (up-down). La luz indirecta está solo disponible para versiones on-off y regulación DALI (DA), ambas en 24VdC. - Las luminarias UP llevan la misma temperatura de color arriba y abajo (arriba-abajo).

*3 Down light (direct light) works at 500mA. La luz directa trabaja a 500mA.

Some product variations require an IP Box, seek advice from our technical team. Algunas variaciones del producto requieren de una IP Box, consulte con nuestro equipo técnico

*4 Miter cut diffuser. Difusor a inglete.



FINISHES

• COLORS



DIMENSIONS

• ELECTRIC SYSTEM LENGTH mm.

843 | 1124 | 1405 | 1686 | 1967 | 2248

LIGHTING OPTIONS

■ DIFFUSERS

OPAL | MICROPRISMATIC

POWER

STANDARD | HIGH

CRI

90

COLOR TEMPERATURE

2700K | 3000K | 4000K | TW

▼ DIMMABLE OPTIONS

DALI | 1.10 | PUSH

▲ LIGHT DISTRIBUTION

DOWN | UP-DOWN

LUMINAIRE INCLUDES

.PN

1 Switch
2 x Suspension cables 3m
NON-DIM: 1 x Feed Hose 3 x 0,75mm²
DIM: 1 x Feed Hose 5 x 0,75mm²

.SR

Surface mounting kit

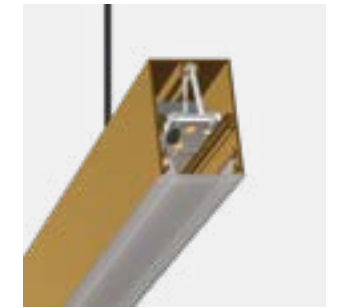
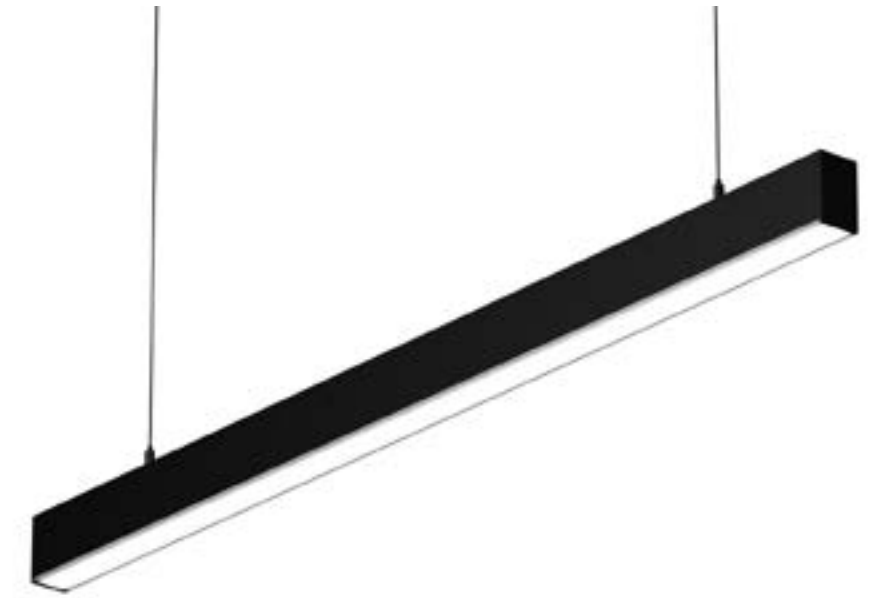

ON DEMAND

Special RAL Color
Emergency Lighting*
Motion Detection
Custom dimensions
Special Color Temperature
RGB
Thematic LED
Wireless Control Options (Casambi)
CRI 80

* Delivered separately
(not installed in luminaire).

INSTALLATIONS



ALBA

REF 10160.PN | 10160.SR

.PN
PENDANT

·10160 ALBA | PN
Pag. 230

.WS
WALL SURFACE

·10160 ALBA | WS
Pag. 786

.TK
TRACK

·10160 ALBA | TK
Pag. 760

.SR
SURFACE

·10160 ALBA | SR
Pag. 230

.RF
RECESSED FRAME

·10160 ALBA | RF
Pag. 444

.TR
TRIMLESS

·10160 ALBA | TR
Pag. 644

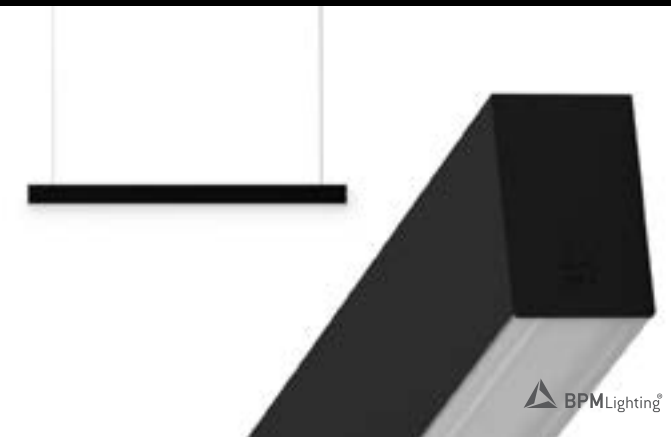
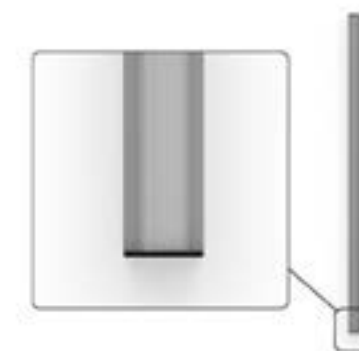

REF.	ELECTRIC SYSTEM LENGTH		FINISH	DIFFUSER	POWER	CRI	DOWNLIGHT *3 LUMEN				WATT		UPLIGHT ▲.UP *2 LUMEN			WATT		DIMM ▼
	MM	MM					.27	.30	.40	.TW *1	K	TW	.27	.30	.40	K		
10160	.03	843	●	.OP .MP	.ST	.9	2295	2385	2475	5700-5910	18	38	397	405	425	4	.DA .PU .D1	
	.04	1124					3060	3180	3300	7600-7880	24	51	622	634	666	6		
	.05	1405					3825	3975	4125	9500-9850	30	64	824	840	882	8		
	.06	1686					4590	4770	4950	11400-11820	36	76	1034	1054	1107	10		
	.07	1967					5355	5565	5775	13300-13790	42	89	1243	1268	1331	12		
	.08	2248					6120	6360	6600	15200-15760	48	102	1460	1490	1564	14		

REF.	ELECTRIC SYSTEM LENGTH		FINISH	DIFFUSER	POWER	CRI	DOWNLIGHT *3 LUMEN			UPLIGHT ▲.UP *2 LUMEN			WATT		DIMM ▼	
	MM	MM					.27	.30	.40	.27	.30	.40	K			
10160	.03	843	●	.OP .MP	.HI	.9	4590	4767	4956	36		643	683	722	8	.DA .PU .D1
	.04	1124					6120	6356	6608	48		1007	1069	1131	12	
	.05	1405					7650	7945	8260	60		1334	1417	1500	16	
	.06	1686					9180	9534	9912	72		1674	1777	1881	20	
	.07	1967					10710	11123	11564	84		2014	2138	2263	24	
	.08	2248					12240	12712	13216	96		2366	2512	2658	28	

Reference order | 10160.XX | .SR | .PN | .XX.XX.XX.9.XX.XX.XX

Total length = Electric System Length + 20mm + 2x3mm (Cover kit)

● Select finishes



COMPONENTS

COVER KIT	REF.	FINISH
	TF02 2x3mm.	●

Reference order | TF02 | .SR | .PN | .XX

REDUGER	REF.	POWER
	ACC.RG	.ST .HI

Reference order | ACC.RG.XX

JOINTS

LINEAR JOINT	ANGLE JOINT*4	T-JOINT	CROSS JOINT	WALL-CEILING JOINT	FINISH
					●
UR02	UL02	UT02	UC02	UV02	

Joints, other than Linear joint, require a technical drawing

Reference order | XX02 | .SR | .PN | .XX

OPTIONS (.PN)

SUSPENSION KIT	REF.	DIMEN-SION	FINISH
	SC05	5M.	.SA
	SC07	7M.	
	SC10	10M.	

Reference order | SCXX.SA

SUSPENSION ROD	REF.	DIMEN-SIONS	mm	FINISH
	SC21	.60	600	●
		.80	800	
		.100	1000	

Reference order | SC21.XX.XX

Not-included, please select:

CONNECTION BOX	FINISH
	●
CB09.12	

Reference order | CB09.12.XX

ALBA

REF 10160.PN | 10160.SR

PHOTOMETRY

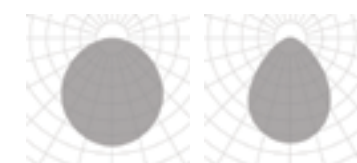

OPAL MICROPRISMATIC

INCLUDED (.PN)

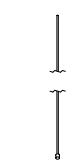

SC03.SA WIRE 3M.

PROFILE

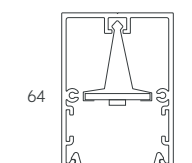

64 43

*1 Tunable White (TW) values correspond to 2700K and 6500K. -TW is only available for DALI DT8 dimmable (DA), CRI 80 (8) 700mA. Los valores del blanco dinámico (TW) corresponden a 2700K y 6500K. -TW solo está disponible con protocolo DALI DT8 (DA), CRI 80 (8) 700mA.

*2 Uplight (UP) is only available for ON-OFF and DALI dimmable (DA) options, both in 24VdC. -UP luminaires carry the same color temperature above and below (up-down).

La luz indirecta está solo disponible para versiones on-off y regulación DALI (DA), ambas en 24VdC. - Las luminarias .UP llevan la misma temperatura de color arriba y abajo (arriba-abajo).

*3 Down light (direct light) works at 500mA. La luz directa trabaja a 500mA.

Some product variations require an IP Box, seek advice from our technical team. Algunas variaciones del producto requieren de una IP Box, consulte con nuestro equipo técnico

*4 Miter cut diffuser. Difusor a inglete.



new

FINISHES

● COLORS



DIMENSIONS

◆ ELECTRIC SYSTEM LENGTH mm.

843 | 1124 | 1405 | 1686 | 1967 | 2248

LIGHTING OPTIONS

■ DIFFUSERS

OPAL | MICROPRISMATIC

POWER

STANDARD | HIGH

CRI

90

COLOR TEMPERATURE

2700K | 3000K | 4000K | TW

▼ DIMMABLE OPTIONS

ON DEMAND

▲ LIGHT DISTRIBUTION

UP-DOWN

LUMINAIRE INCLUDES

1 Switch
 2 x Suspension cables 3m
 NON-DIM: 1 x Feed Hose 3 x 0,75mm²
 DIM: 1 x Feed Hose 5 x 0,75mm²

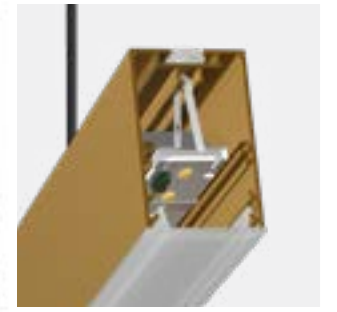

ON DEMAND

Special RAL Color
 Emergency Lighting*
 Motion Detection
 Custom dimensions
 Special Color Temperature
 RGB
 Thematic LED
 Wireless Control Options (Casambi)
 CRI 80

* Delivered separately
 (not installed in luminaire).

INSTALLATIONS



ALBA NOVUS

REF 210011.PN

.PN
PENDANT

210011 ALBA NOVUS | PN
Pag. 234

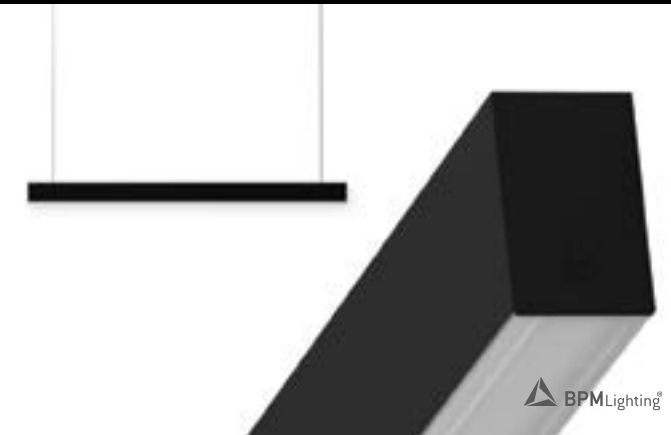
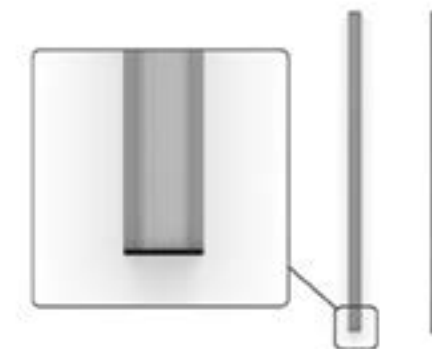

PENDANT

.PN

REF.	ELECTRIC SYSTEM LENGTH		FINISH	DIFFUSER	POWER	CRI	DOWNLIGHT *4 LUMEN				WATT		UPLIGHT ▲.UP *3 LUMEN			WATT		DIMM ▼
	MM	MM					.27	.30	.40	.TW *2	K	TW	.27	.30	.40	K		
210011	.03	843	●	.OP .MP	.ST	.9	2295	2385	2475	5700-5910	18	38	265	274	349	4	.DA*1	
	.04	1124					3060	3180	3300	7600-7880	24	51	397	411	522	6		
	.05	1405					3825	3975	4125	9500-9850	30	64	259	548	696	8		
	.06	1686					4590	4770	4950	11400-11820	36	76	661	685	870	10		
	.07	1967					5355	5565	5775	13300-13790	42	89	793	822	1044	12		
	.08	2248					6120	6360	6600	15200-15760	48	102	925	958	1218	14		

REF.	ELECTRIC SYSTEM LENGTH		FINISH	DIFFUSER	POWER	CRI	DOWNLIGHT *4 LUMEN			UPLIGHT ▲.UP *3 LUMEN			WATT		DIMM ▼
	MM	MM					.27	.30	.40	.27	.30	.40	K		
210011	.03	843	●	.OP .MP	.HI	.9	4590	4767	4956	36	568	587	747	8	.DA*1
	.04	1124					6120	6356	6608	48	851	880	1119	13	
	.05	1405					7650	7945	8260	60	1134	1173	1492	17	
	.06	1686					9180	9534	9912	72	1417	1466	1864	21	
	.07	1967					10710	11123	11564	84	1701	1760	2237	25	
	.08	2248					12240	12712	13216	96	1984	2053	2610	30	

Reference order | 210011.XX.PN.XX.XX.XX.9.XX.DA.XX

Total length = Electric System Length + 20mm + 2x3mm (Cover kit)

● Select finishes



COMPONENTS

COVER KIT	REF.	FINISH
	TF07 2x3mm.	●

Reference order | TF07.PN.XX

REDUGER	REF.	POWER
	ACC.RG	.ST .HI

Reference order | ACC.RG.XX

JOINTS

LINEAR JOINT	ANGLE JOINT *5	ANGLE JOINT 2 LINES	ANGLE JOINT 3 LINES	CROSS JOINT	WALL-CEILING JOINT	FINISH
				X	X	●
UR07	UL07	AM07	AMY07	X	X	

Joints, other than Linear joint, require a technical drawing

Reference order | XX07.SR.PN.XX

OPTIONS (.PN)

SUSPENSION KIT	REF.	DIMENSION	FINISH
	SC05	5M.	.SA
	SC07	7M.	
	SC10	10M.	

Reference order | SCXX.SA

SUSPENSION ROD	REF.	DIMENSIONS	mm	FINISH
	SC21	.60	600	●
		.80	800	
		.100	1000	

Reference order | SC21.XX.XX

Not-included, please select:

CONNECTION BOX	FINISH
	●
CB09.12	

Reference order | CB09.12.XX

ALBA NOVUS

REF 210011.PN

PHOTOMETRY



OPAL MICROPRISMATIC

INCLUDED

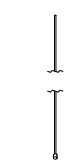

SC03.SA WIRE 3M.

PROFILE

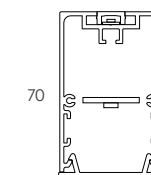

70 43

*1 DALI protocol requires remote driver. *Protocolo DALI requiere driver en remoto.*
 *2 Tunable White (TW) values correspond to 2700K and 6500K - TW is only available for DALI DT8 dimmable (.DA), CRI 80 (8) 700mA. - TWUP luminaires have 3000K indirect light by default, for other options, please check with sales team. *Los valores del blanco dinámico (TW) corresponden a 2700K y 6500K. - TW solo está disponible con protocolo DALI DT8 (.DA), CRI 80 (8) 700mA. - Las luminarias.TW UP tienen luz indirecta de 3000K, para otras opciones, consultar con el equipo comercial.*
 *3 Uplight (UP) is only available for ON-OFF and DALI dimmable (.DA) options, both in 24VdC. - UP luminaires carry the same color temperature above and below (up-down). *La luz indirecta está solo disponible para versiones on-off y regulación DALI (.DA), ambas en 24VdC. - Las luminarias UP llevan la misma temperatura de color arriba y abajo (arriba-abajo).*
 *4 Down light (direct light) works at 500mA. *La luz directa trabaja a 500mA.*
 *5 Miter cut diffuser. *Difusor a inglete.*

PENDANT .PN



new

FINISHES

● COLORS



DIMENSIONS

◆ ELECTRIC SYSTEM LENGTH mm.

843 | 1124 | 1405 | 1686 | 1967 | 2248

LIGHTING OPTIONS

■ DIFFUSERS

OPAL | MICROPRISMATIC

POWER

STANDARD

CRI

90

COLOR TEMPERATURE

2700K | 3000K | 4000K | TW

▼ DIMMABLE OPTIONS

DALI

▲ LIGHT DISTRIBUTION

UP - DOWN

LUMINAIRE INCLUDES

1 Switch
 2 x Suspension cables 3m
 NON-DIM: 1 x Feed Hose 3 x 0,75mm²
 DIM: 1 x Feed Hose 5 x 0,75mm²

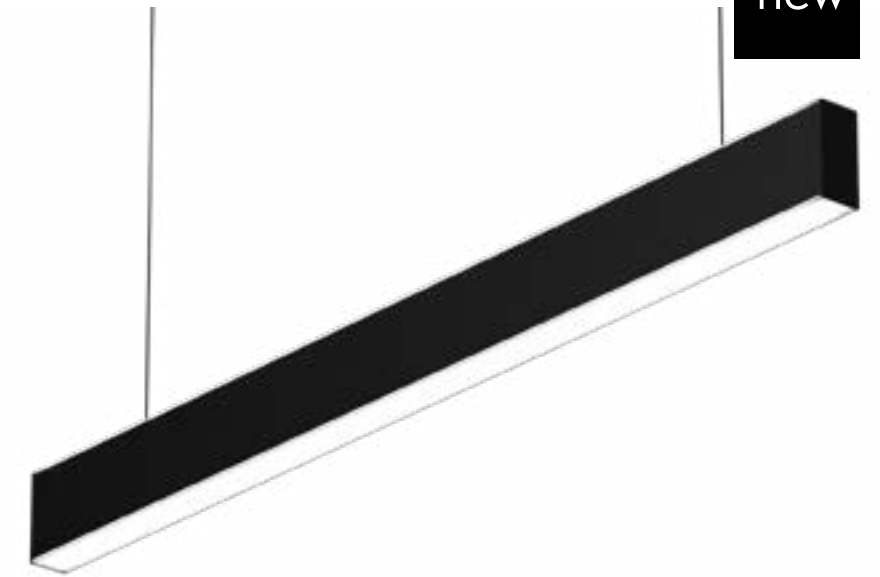

ON DEMAND

Special RAL Color
 Emergency Lighting*
 Motion Detection
 Custom dimensions
 Special Color Temperature
 RGB
 Thematic LED
 Wireless Control Options (Casambi)
 CRI 80
 HI power

* Delivered separately
 (not installed in luminaire).

INSTALLATIONS



.PN
 PENDANT

·10215 ALBA DOUBLE | PN
 Pag. 238



.WS
 WALL SURFACE

·10215 ALBA DOUBLE | WS
 Pag. 790



ALBA DOUBLE

REF 10215.PN

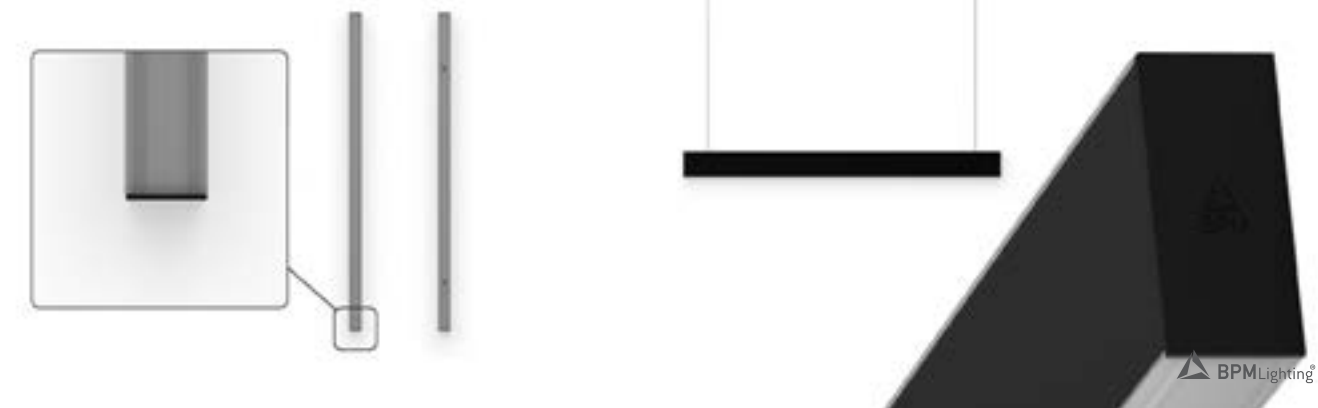

PENDANT .PN

REF.	ELECTRIC SYSTEM LENGTH		FINISH	DIFFUSER	POWER	CRI	DOWNLIGHT *2 LUMEN				WATT		UPLIGHT ▲.UP *3 LUMEN				WATT		DIMM ▼
	●	MM					.27	.30	.40	.TW *1	K	TW	.27	.30	.40	.TW *1	K	TW	
10215	.03	843	●	.OP .MP	.ST	.9	2295	2385	2475	5700-5910	18	38	2295	2385	2475	5700-5910	18	38	.DA
	.04	1124					3060	3180	3300	7600-7880	24	51	3060	3180	3300	7600-7880	24	51	
	.05	1405					3825	3975	4125	9500-9850	30	64	3825	3975	4125	9500-9850	30	64	
	.06	1686					4590	4770	4950	11400-11820	36	76	4590	4770	4950	11400-11820	36	76	
	.07	1967					5355	5565	5775	13300-13790	42	89	5355	5565	5775	13300-13790	42	89	
	.08	2248					6120	6360	6600	15200-15760	48	102	6120	6360	6600	15200-15760	48	102	

Reference order | 10215.XX.PN.XX.XX.ST9.XX.XX.UP

COMPONENTS

COVER KIT	REF.	FINISH
	TF04 2x3mm.	●

Reference order | TF04.SR.PN.XX

JOINTS

LINEAR JOINT
UR04



OPTIONS (.PN)

SUSPENSION KIT	REF.	DIMENSION	FINISH
	SC05	5M.	.SA
	SC07	7M.	
	SC10	10M.	

Reference order | SCXX.SA

SUSPENSION ROD	REF.	DIMENSIONS ●	mm	FINISH
	SC21	.60	600	●
		.80	800	
		.100	1000	

Reference order | SC21.XX.XX

Not-included, please select:

CONNECTION BOX	FINISH
	●
CB09.12	

Reference order | CB09.12.XX

Total length = Electric System Length + 44mm + 2x3mm (Cover kit)

● Select finishes



.WH-WH .BK-BK .GC-GC .BM-BM .BS-BS .BC-BC .CR-CR .CB-CB .GY-GY .MG-MG .VC-VC .YM-YM

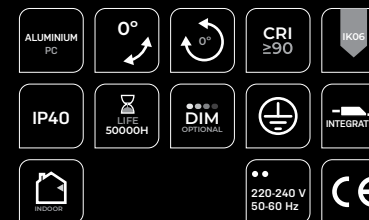

ALBA DOUBLE

REF 10215.PN

PHOTOMETRY



OPAL MICROPRISMATIC

INCLUDED (.PN)

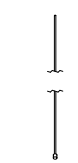

SC03.SA
WIRE 3M.

PROFILE

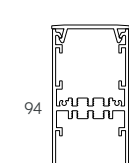

94
43

*1 Tunable White (TW) values correspond to 2700K and 6500K - TW is only available for DALI DT8 dimmable (DA), CRI 80 (8) 700mA. Los valores del blanco dinámico (TW) corresponden a 2700K y 6500K. - TW solo está disponible con protocolo DALI DT8 (DA), CRI 80 (8) 700mA.

*2 Down light (direct light) work at 500mA. La luz directa trabaja a 500mA.

*3 Uplight (UP) is only available for ON-OFF and DALI dimmable (.DA) options, both in 24VdC. - UP luminaires carry the same color temperature above and below (up-down).

La luz indirecta está solo disponible para versiones on-off y regulación DALI (.DA), ambas en 24VdC. - Las luminarias UP llevan la misma temperatura de color arriba y abajo (arriba-abajo).



FINISHES

EXTERNAL COLOR



INTERNAL COLOR



ELECTRIC SYSTEM LENGTH mm.

843 | 1124 | 1405 | 1686 | 1967 | 2248

LIGHTING OPTIONS

DIFFUSERS

TRANSPARENT

POWER

STANDARD | HIGH

CRI

90

COLOR TEMPERATURE

2700K | 3000K | 4000K | TW

DIMMABLE OPTIONS

DALI | 1.10 | PUSH

LIGHT DISTRIBUTION

ASYMETRIC DOWN

LUMINAIRE INCLUDES

.PN

1 Switch
2 x Suspension cables 3m
NON-DIM: 1 x Feed Hose 3 x 0,75mm²
DIM: 1 x Feed Hose 5 x 0,75mm²

.SR

Surface mounting kit



Optimal distance from the wall: 0.5m.
Distancia óptima con respecto a la pared: 0.5m.

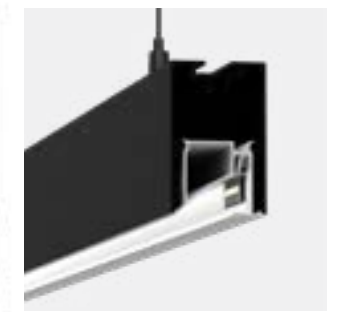

ON DEMAND

Special RAL Color
Emergency Lighting*
Special Color Temperature
RGB
Thematic LED
Wireless Control Options (Casambi)
CRI 80

* Delivered separately
(not installed in luminaire).

INSTALLATIONS



ALBA ASIMETRIC

REF 210009.PN | 210009.SR



.PN
PENDANT

·210009 ALBA ASIMETRIC
| PN - Pag. 242



.WS
WALL SURFACE

·210009 ALBA ASIMETRIC
| WS - Pag. 794



.SR
SURFACE

·210009 ALBA ASIMETRIC
| SR - Pag. 242



.RF
RECESSED FRAME

·210009 ALBA ASIMETRIC
| RF - Pag. 448



.TR
TRIMLESS

·210009 ALBA ASIMETRIC
| TR - Pag. 648

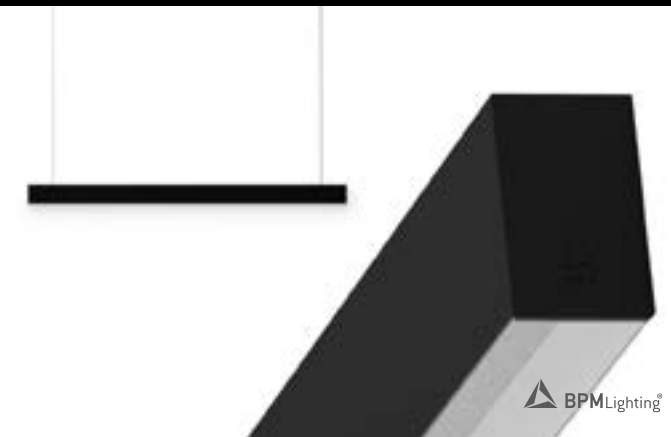
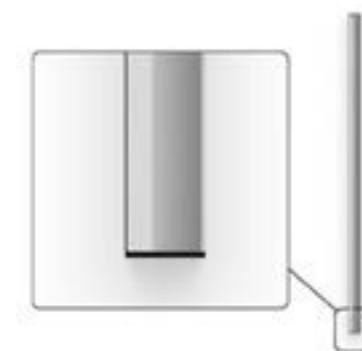

REF.	ELECTRIC SYSTEM LENGTH		FINISH	DIFFUSER	POWER	CRI	DOWNLIGHT *2 LUMEN				WATT		UPLIGHT ▲.UP *3 LUMEN			WATT		DIMM
	MM	MM					.27	.30	.40	.TW *1	K	TW	.27	.30	.40	K		
210009	.03	843	●	.TP	.ST	.9	2295	2385	2475	5700-5910	18	38	397	405	425	4	.DA .PU .D1	
	.04	1124					3060	3180	3300	7600-7880	24	51	622	634	666	6		
	.05	1405					3825	3975	4125	9500-9850	30	64	824	840	882	8		
	.06	1686					4590	4770	4950	11400-11820	36	76	1034	1054	1107	10		
	.07	1967					5355	5565	5775	13300-13790	42	89	1243	1268	1331	12		
	.08	2248					6120	6360	6600	15200-15760	48	102	1460	1490	1564	14		

REF.	ELECTRIC SYSTEM LENGTH		FINISH	DIFFUSER	POWER	CRI	DOWNLIGHT *2 LUMEN			UPLIGHT ▲.UP *3 LUMEN			WATT		DIMM
	MM	MM					.27	.30	.40	.27	.30	.40	K		
210009	.03	843	●	.TP	.HI	.9	4590	4767	4956	36	643	683	722	8	.DA .PU .D1
	.04	1124					6120	6356	6608	48	1007	1069	1131	12	
	.05	1405					7650	7945	8260	60	1334	1417	1500	16	
	.06	1686					9180	9534	9912	72	1674	1777	1881	20	
	.07	1967					10710	11123	11564	84	2014	2138	2263	24	
	.08	2248					12240	12712	13216	96	2366	2512	2658	28	

Reference order | 210009.XX | .SR | .PN | .XX.XX.XX | .9 | .XX.XX

Total length = Electric System Length + 20mm + 2x3mm (Cover kit)

● Select finish



COMPONENTS

COVER KIT	REF.	FINISH
	TF06	●
	2x3mm.	

Reference order | TF06 | .SR | .PN | .XX

JOINTS

LINEAR JOINT
UR06

OPTIONS (.PN)

SUSPENSION KIT	REF.	DIMENSION	FINISH
	SC05	5M.	.SA
	SC07	7M.	
	SC10	10M.	

Reference order | SCXX.SA

SUSPENSION ROD	REF.	DIMENSIONS	mm	FINISH
	SC21	.60	600	●
		.80	800	
		.100	1000	

Reference order | SC21.XX.XX

Not-included, please select:

CONNECTION BOX	FINISH
	●
CB09.12	

Reference order | CB09.12.XX



PHOTOMETRY



TRANSPARENT PC

INCLUDED (.PN)



SC03.SA
WIRE 3M.

PROFILE

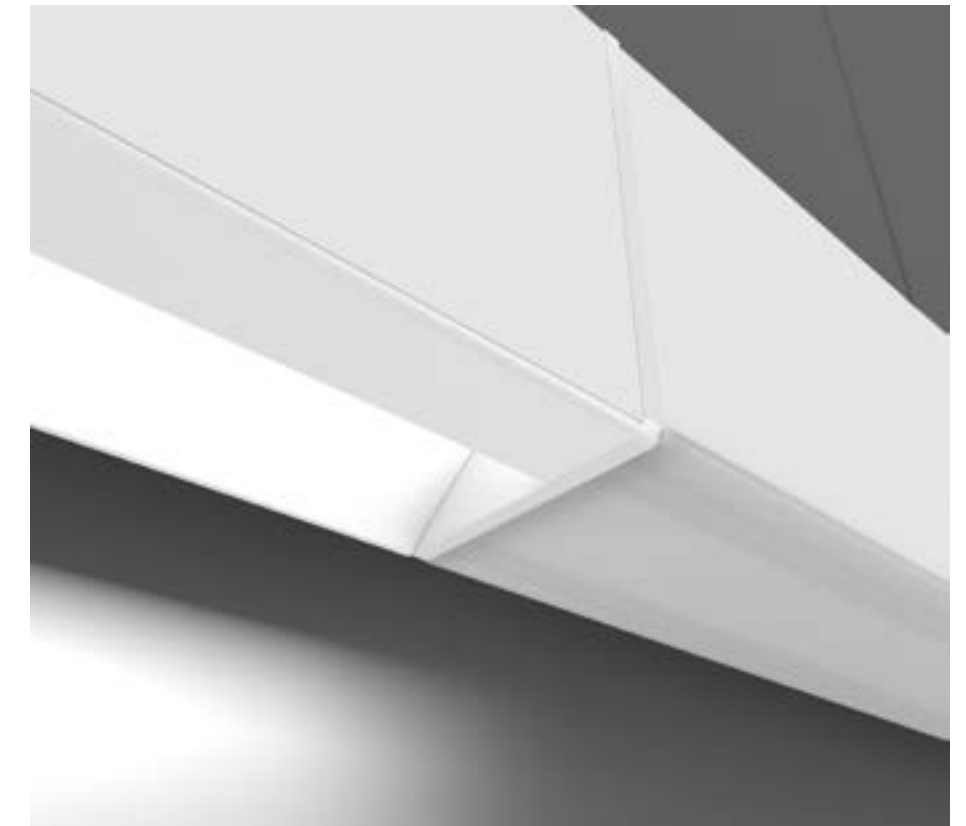
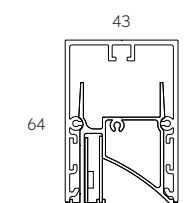

ALBA ASIMETRIC

REF 210009.PN | 210009.SR

PENDANT | SURFACE

*1 Tunable White (TW) values correspond to 2700K and 6500K - TW is only available for DALI DT8 dimmable (DA), CRI 80 (8) 700mA. Los valores del blanco dinámico (TW) corresponden a 2700K y 6500K. -TW solo está disponible con protocolo DALI DT8 (DA), CRI 80 (8) 700mA.

*2 Down light (direct light) work at 500mA. La luz directa trabaja a 500mA.

*3 Uplight (UP) is only available for ON-OFF and DALI dimmable (DA) options, both in 24VdC. - UP luminaires carry the same color temperature above and below (up-down).

La luz indirecta está solo disponible para versiones on-off y regulación DALI (DA), ambas en 24VdC. - Las luminarias UP llevan la misma temperatura de color arriba y abajo (arriba-abajo).



FINISHES

• COLORS



DIMENSIONS

• ELECTRIC SYSTEM LENGTH mm.

843 | 1124 | 1405 | 1686 | 1967 | 2248

LIGHTING OPTIONS

■ DIFFUSERS

OPAL | MICROPRISMATIC

POWER

STANDARD | HIGH

CRI

90

COLOR TEMPERATURE

2700K | 3000K | 4000K | TW

▼ DIMMABLE OPTIONS

DALI | 1.10 | PUSH

▲ LIGHT DISTRIBUTION

DOWN | UP-DOWN

LUMINAIRE INCLUDES

.PN

1 Switch
2 x Suspension cables 3m
NON-DIM: 1 x Feed Hose 3 x 0,75mm²
DIM: 1 x Feed Hose 5 x 0,75mm²

.SR

Surface mounting kit

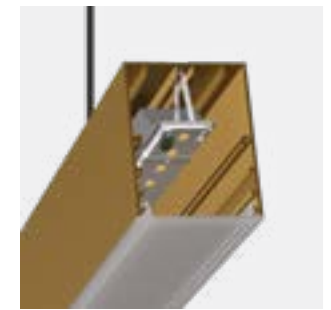
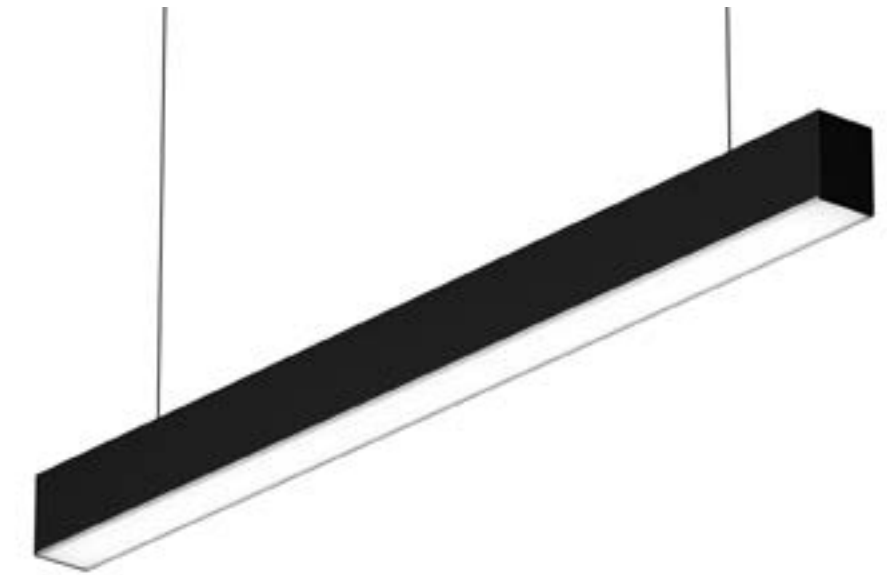

ON DEMAND

Special RAL Color
Emergency Lighting*
Motion Detection
Custom dimensions
Special Color Temperature
RGB
Thematic LED
Wireless Control Options (Casambi)
CRI 80

* Delivered separately
(not installed in luminaire).

INSTALLATIONS



ALBA PLUS

REF 10178.PN | 10178.SR

.PN
PENDANT

10178 ALBA PLUS | PN
Pag. 246

.TK
TRACK

10178 ALBA PLUS | TK
Pag. 764

.SR
SURFACE

10178 ALBA PLUS | SR
Pag. 246

.RF
RECESSED FRAME

10178 ALBA PLUS | RF
Pag. 452

.TR
TRIMLESS

10178 ALBA PLUS | TR
Pag. 652

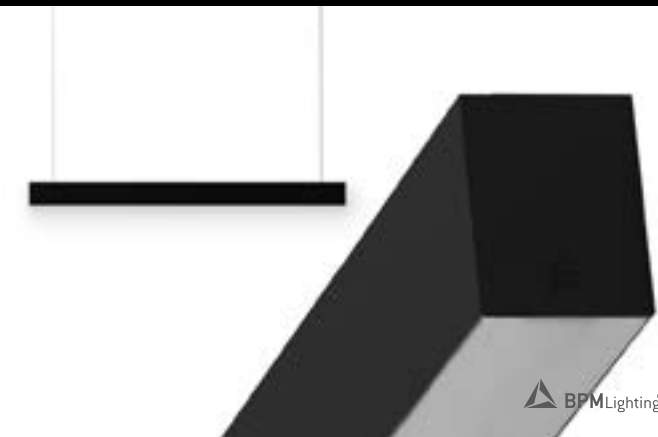
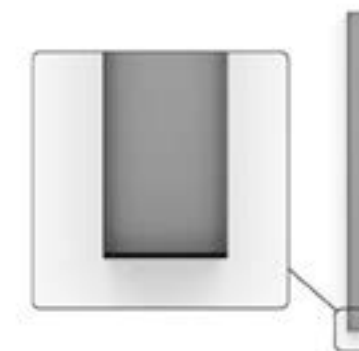

REF.	ELECTRIC SYSTEM LENGTH		FINISH	DIFFUSER	POWER	CRI	DOWNLIGHT *3 LUMEN				WATT		UPLIGHT ▲.UP *2 LUMEN			WATT		DIMM ▼
	MM	MM					.27	.30	.40	.TW *1	K	TW	.27	.30	.40	K	K	
10178	.03	843	●	.OP .MP	.ST	.9	2295	2385	2475	5700-5910	18	38	397	405	425	4	.DA .PU .D1	
	.04	1124					3060	3180	3300	7600-7880	24	51	622	634	666	6		
	.05	1405					3825	3975	4125	9500-9850	30	64	824	840	882	8		
	.06	1686					4590	4770	4950	11400-11820	36	76	1034	1054	1107	10		
	.07	1967					5355	5565	5775	13300-13790	42	89	1243	1268	1331	12		
	.08	2248					6120	6360	6600	15200-15760	48	102	1460	1490	1564	14		

REF.	ELECTRIC SYSTEM LENGTH		FINISH	DIFFUSER	POWER	CRI	DOWNLIGHT *3 LUMEN				WATT		UPLIGHT ▲.UP *2 LUMEN			WATT		DIMM ▼
	MM	MM					.27	.30	.40			.27	.30	.40	K	K		
10178	.03	843	●	.OP .MP	.HI	.9	4590	4767	4956	36	643	683	722	8	.DA .PU .D1			
	.04	1124					6120	6356	6608	48	1007	1069	1131	12				
	.05	1405					7650	7945	8260	60	1334	1417	1500	16				
	.06	1686					9180	9534	9912	72	1674	1777	1881	20				
	.07	1967					10710	11123	11564	84	2014	2138	2263	24				
	.08	2248					12240	12712	13216	96	2366	2512	2658	28				

Reference order | 10178.XX | .SR | .PN | .XX.XX.XX.9.XX.XX.XX

Total length = Electric System Length + 20mm + 2x3mm (Cover kit)

● Select finishes

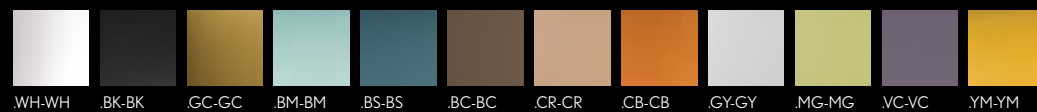

COMPONENTS

COVER KIT	REF.	FINISH
	TF01 2x3mm.	●

Reference order | TF01 | .SR | .PN | .XX

REDUGER	REF.	POWER
	ACC.RG	.ST .HI

Reference order | ACC.RG.XX

JOINTS

LINEAR JOINT	ANGLE JOINT *4	T-JOINT	CROSS JOINT	WALL-CEILING JOINT	FINISH
					●
UR01	UL01	UT01	UC01	UV01	

Joints, other than Linear joint, require a technical drawing

Reference order | XX01 | .SR | .PN | .XX

OPTIONS (.PN)

SUSPENSION KIT	REF.	DIMENSION	FINISH
	SC05	5M.	.SA
	SC07	7M.	
	SC10	10M.	

Reference order | SCXX.SA

SUSPENSION ROD	REF.	DIMENSIONS ●	mm	FINISH
	SC21	.60	600	●
		.80	800	
		.100	1000	

Reference order | SC21.XX.XX

Not-included, please select:

CONNECTION BOX	FINISH
	●
CB09.12	

Reference order | CB09.12.XX

ALBA PLUS

REF 10178.PN | 10178.SR

PHOTOMETRY

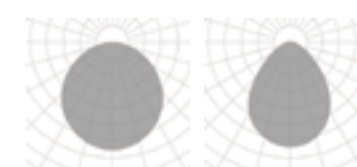

OPAL MICROPRISMATIC

INCLUDED (.PN)

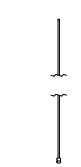

SC03.SA WIRE 3M.

PROFILE

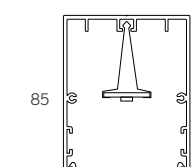

85 65

*1 Tunable White (TW) values correspond to 2700K and 6500K - TW is only available for DALI DT8 dimmable (DA), CRI 80 (8) 700mA. Los valores del blanco dinámico (TW) corresponden a 2700K y 6500K. - TW solo está disponible con protocolo DALI DT8 (DA), CRI 80 (8) 700mA.

*2 Uplight (UP) is only available for ON-OFF and DALI dimmable (DA) options, both in 24VdC. - UP luminaires carry the same color temperature above and below (up-down).

La luz indirecta está solo disponible para versiones on-off y regulación DALI (DA), ambas en 24VdC. - Las luminarias UP llevan la misma temperatura de color arriba y abajo (arriba-abajo).

*3 Down light (direct light) works at 500mA. La luz directa trabaja a 500mA.

*4 Miter cut diffuser. Difusor a inglete.



new

FINISHES

EXTERNAL COLOR



INTERNAL COLOR



ELECTRIC SYSTEM LENGTH mm.

843 | 1124 | 1405 | 1686 | 1967 | 2248

LIGHTING OPTIONS

DIFFUSERS

TRANSPARENT

POWER

STANDARD | HIGH

CRI

90

COLOR TEMPERATURE

2700K | 3000K | 4000K | TW

DIMMABLE OPTIONS

DALI | 1.10 | PUSH

LIGHT DISTRIBUTION

ASYMETRIC DOWN

LUMINAIRE INCLUDES

.PN

1 Switch
2 x Suspension cables 3m
NON-DIM: 1 x Feed Hose 3 x 0,75mm²
DIM: 1 x Feed Hose 5 x 0,75mm²

.SR

Surface mounting kit

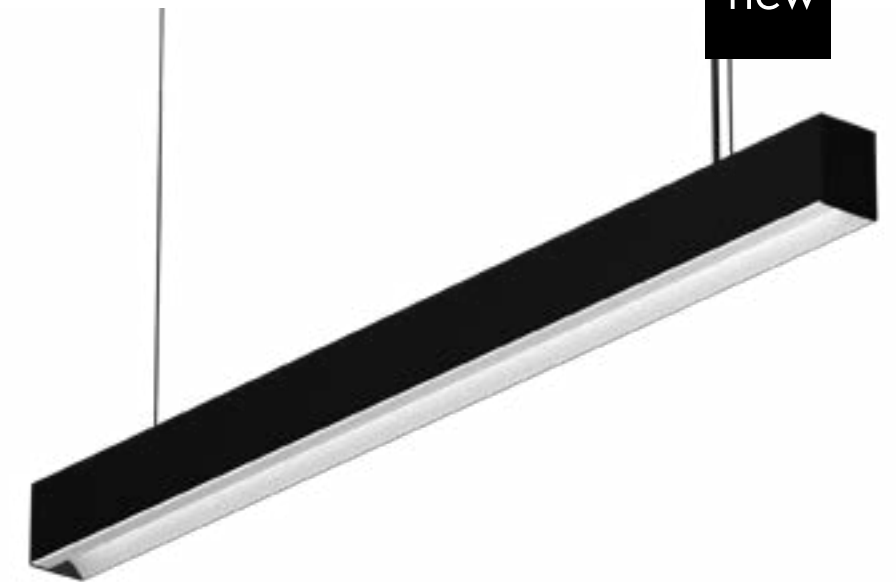

Optimal distance from the wall: 0.5m.
Distancia óptima con respecto a la pared: 0.5m.

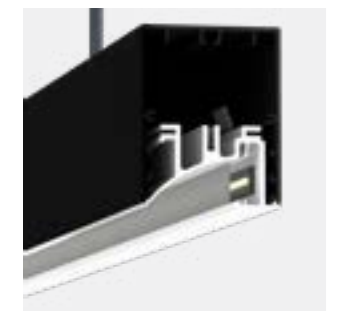

ON DEMAND

Special RAL Color
Emergency Lighting*
Custom dimensions
Special Color Temperature
RGB
Thematic LED
Wireless Control Options (Casambi)
CRI 80
Motion Detection

* Delivered separately
(not installed in luminaire).

INSTALLATIONS



ALBA PLUS ASIMETRIC

REF 210008.PN | 210008.SR

.PN
PENDANT

·210008 ALBA PLUS
ASIMETRIC | PN - Pag. 250

.SR
SURFACE

·210008 ALBA PLUS
ASIMETRIC | SR - Pag. 250

.RF
RECESSED FRAME

·210008 ALBA PLUS
ASIMETRIC | RF - Pag. 456

.TR
TRIMLESS

·210008 ALBA PLUS
ASIMETRIC | TR - Pag. 656

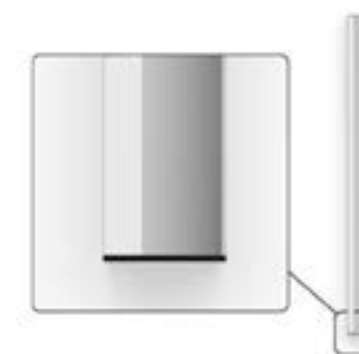

REF.	ELECTRIC SYSTEM LENGTH		FINISH	DIFFUSER	POWER	CRI	DOWNLIGHT *3 LUMEN				WATT		UPLIGHT ▲.UP *2 LUMEN			WATT		DIMM ▼
	MM	MM					.27	.30	.40	.TW *1	K	TW	.27	.30	.40	K	K	
210008	.03	843	●	.TP	.ST	.9	2295	2385	2475	5700-5910	18	38	397	405	425	4	.DA .PU .D1	
	.04	1124					3060	3180	3300	7600-7880	24	51	622	634	666	6		
	.05	1405					3825	3975	4125	9500-9850	30	64	824	840	882	8		
	.06	1686					4590	4770	4950	11400-11820	36	76	1034	1054	1107	10		
	.07	1967					5355	5565	5775	13300-13790	42	89	1243	1268	1331	12		
	.08	2248					6120	6360	6600	15200-15760	48	102	1460	1490	1564	14		

REF.	ELECTRIC SYSTEM LENGTH		FINISH	DIFFUSER	POWER	CRI	DOWNLIGHT *3 LUMEN			UPLIGHT ▲.UP *2 LUMEN			WATT		DIMM ▼
	MM	MM					.27	.30	.40	.27	.30	.40	K	TW	
210008	.03	843	●	.TP	.HI	.9	4590	4767	4956	36	643	683	722	8	.DA .PU .D1
	.04	1124					6120	6356	6608	48	1007	1069	1131	12	
	.05	1405					7650	7945	8260	60	1334	1417	1500	16	
	.06	1686					9180	9534	9912	72	1674	1777	1881	20	
	.07	1967					10710	11123	11564	84	2014	2138	2263	24	
	.08	2248					12240	12712	13216	96	2366	2512	2658	28	

Reference order | 210008.XX | .SR | .PN | .XX.XX.XX | .9.XX.XX

Total length = Electric System Length + 20mm + 2x3mm (Cover kit)

● Select finish



COMPONENTS

COVER KIT	REF.	FINISH
	TF05	●
	2x3mm.	

Reference order | TF05 | .SR | .PN | .XX

JOINTS

LINEAR JOINT
UR05

OPTIONS (.PN)

SUSPENSION KIT	REF.	DIMENSION	FINISH
	SC05	5M.	.SA
	SC07	7M.	
	SC10	10M.	

Reference order | SCXX.SA



SUSPENSION ROD	REF.	DIMENSIONS ●	mm	FINISH
	SC21	.60	600	●
		.80	800	
		.100	1000	

Reference order | SC21.XX.XX

Not-included, please select:

CONNECTION BOX	FINISH
	●
CB09.12	

Reference order | CB09.12.XX

*1 Tunable White (TW) values correspond to 2700K and 6500K - TW is only available for DALI DT8 dimmable (DA), CRI 80 (8) 700mA. Los valores del blanco dinámico (TW) corresponden a 2700K y 6500K. - TW solo está disponible con protocolo DALI DT8 (DA), CRI 80 (8) 700mA.
 *2 Uplight (UP) is only available for ON-OFF and DALI dimmable (DA) options, both in 24VdC. - UP luminaires carry the same color temperature above and below (up-down). La luz indirecta está solo disponible para versiones on-off y regulación DALI (DA), ambas en 24VdC. - Las luminarias UP llevan la misma temperatura de color arriba y abajo (arriba-abajo).
 *3 Down light (direct light) works at 500mA. La luz directa trabaja a 500mA.

PHOTOMETRY



TRANSPARENT PC

INCLUDED (.PN)



SC03.SA
WIRE 3M.

PROFILE

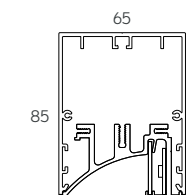

ALBA PLUS ASIMETRIC

REF 210008.PN | 210008.SR

PENDANT | SURFACE

.SR
.PN

PENDANT | SURFACE

ALBA PLUS ASIMETRIC

PHOTOMETRY

INCLUDED (.PN)

TRANSPARENT PC



SOON

FINISHES

● COLORS



DIMENSIONS

◆ ELECTRIC SYSTEM LENGTH mm.

843	1124	1405	1686
800	1520	2950	5100

LIGHTING OPTIONS

■ DIFFUSERS

OPAL

POWER

STANDARD | HIGH

CRI

90

COLOR TEMPERATURE

2700K | 3000K | 4000K

▼ DIMMABLE OPTIONS

DALI | 1.10 | PUSH

▲ LIGHT DISTRIBUTION

DOWN

LUMINAIRE INCLUDES

.PN

1 Switch
2 x Suspension cables 3m
NON-DIM: 1 x Feed Hose 3 x 0,75mm²
DIM: 1 x Feed Hose 5 x 0,75mm²

.SR

Surface mounting kit

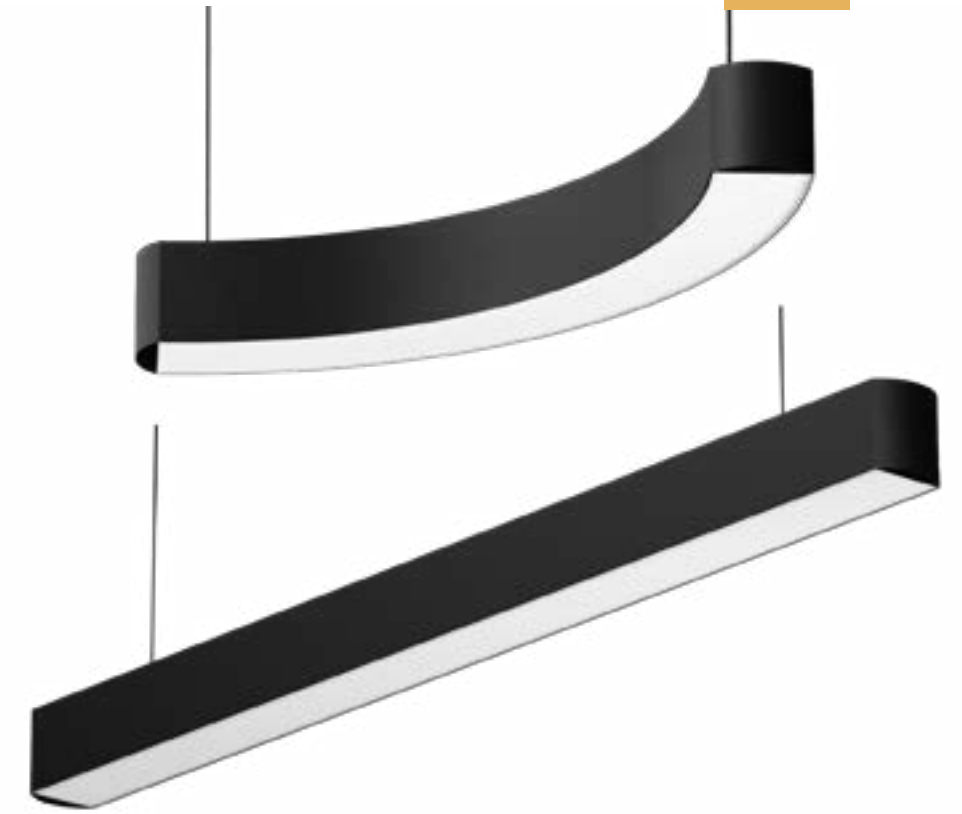

ON DEMAND

Special RAL Color
Emergency Lighting*
Motion Detection
Custom dimensions
Special Color Temperature
RGB
Wireless Control Options (Casambi)

* Delivered separately
(not installed in luminaire).

INSTALLATIONS

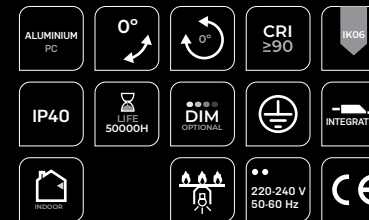

BOLD | BOLD LINE

REF 210001.PN | 210015.PN | 210001.SR | 210015.SR

.PN
PENDANT

·210001 BOLD ·210015 BOLD LINE | PN
Pag. 254

.SR
SURFACE

·210001 BOLD ·210015 BOLD LINE | SR
Pag. 254

.RF
RECESSED FRAME

·210001 BOLD ·210015 BOLD LINE | RF
Pag. 460



BOLD						
.01	.02	.03	.04	.05	.06	.07
800 mm 45°	800 mm 90°	1520 mm 45°	1520 mm 90°	2950 mm 45°	2950 mm 90°	5100 mm 45°

REF.	DIMENSION ▲	FINISH	DIFFUSER ■	POWER	CRI	DOWNLIGHT *1 LUMEN			WATT	DIMM ▼
						.27	.30	.40		
210001	.01	●	.OP	.ST	.9	765	795	825	6	.DA .PU .D1
	.02					1530	1590	1650	12	
	.03					1530	1590	1650	12	
	.04					3060	3180	3300	24	
	.05					3060	3180	3300	24	
	.06					6120	6360	6600	47	
	.07					5355	5565	5775	41	

REF.	DIMENSION ▲	FINISH	DIFFUSER ■	POWER	CRI	DOWNLIGHT *1 LUMEN			WATT	DIMM ▼
						.27	.30	.40		
210001	.01	●	.OP	.HI	.9	1530	1589	1652	12	.DA .PU .D1
	.02					3060	3178	3304	24	
	.03					3060	3178	3304	24	
	.04					6120	6356	6608	47	
	.05					6120	6356	6608	47	
	.06					12240	12712	13216	94	
	.07					10710	11123	11564	83	

Reference order | 210001.XX | .SR | .PN | .XX.XX.XX.9.XX.XX

BOLD LINE	REF.	DIMENSION		FINISH	DIFFUSER ■	POWER	CRI	DOWNLIGHT *1 LUMEN			WATT	DIMM ▼
		▲	MM					.27	.30	.40		
	210015	.03	843	●	.OP .MP	.ST	.9	2295	2385	2475	18	.DA .PU .D1
		.04	1124					3060	3180	3300	24	
		.05	1405					3825	3975	4125	30	
		.06	1686					4590	4770	4950	35	

BOLD LINE	REF.	DIMENSION		FINISH	DIFFUSER ■	POWER	CRI	DOWNLIGHT *1 LUMEN			WATT	DIMM ▼
		▲	MM					.27	.30	.40		
	210015	.03	843	●	.OP .MP	.ST	.9	4590	4767	4956	35	.DA .PU .D1
		.04	1124					6120	6356	6608	47	
		.05	1405					7650	7945	8260	59	
		.06	1686					9180	9534	9912	71	

Reference order | 210015.XX | .SR | .PN | .XX.XX.XX.9.XX.XX

COMPONENTS

COVER KIT	REF.
	TF17

Reference order | TF17.PN.XX

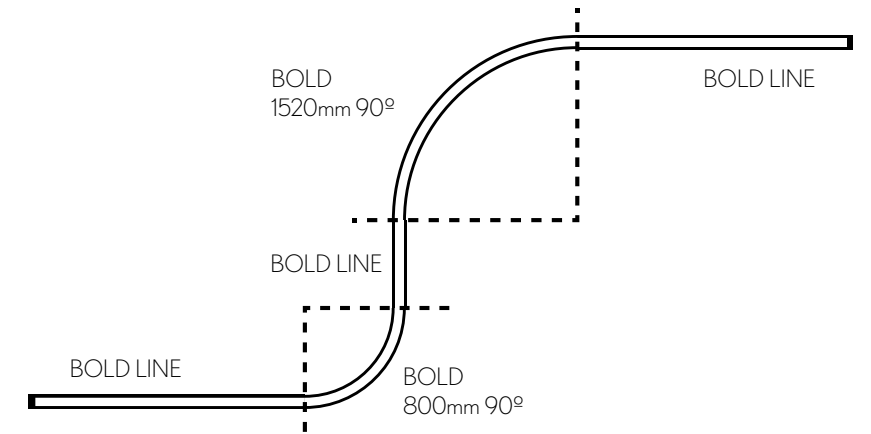

Select lens finishes



BOLD | BOLD LINE

REF 210001.PN | 210015.PN | 210001.SR | 210015.SR

PHOTOMETRY

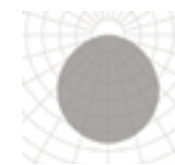

OPAL

INCLUDED (.PN)

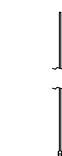

SC03.SA
WIRE 3M.

PROFILE

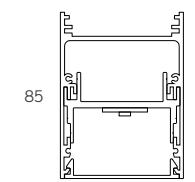

85
65

*1 Down light (direct light) works at 500mA. La luz directa trabaja a 500mA.



FINISHES

● COLORS



DIMENSIONS

● LENGTHS

.01

LIGHTING OPTIONS

■ DIFFUSERS

OPAL

POWER

STANDARD | HIGH

CRI

90

COLOR TEMPERATURE

2700K | 3000K | 4000K

▼ DIMMABLE OPTIONS

DALI | 1.10 | PUSH

▲ LIGHT DISTRIBUTION

DOWN

LUMINAIRE INCLUDES

.PN

1 Switch
2 x Suspension cables 3m
NON-DIM: 1 x Feed Hose 3 x 0,75mm²
DIM: 1 x Feed Hose 5 x 0,75mm²

.SR

Surface mounting kit



ON DEMAND

Emergency Lighting *
Motion Detection
Wireless Control Options (Casambi)

* Delivered separately
(not installed in luminaire).

INSTALLATIONS

.PN
PENDANT

·210018 TRIBOLD | PN
Pag. 258

.SR
SURFACE

·210018 TRIBOLD | SR
Pag. 258



TRIBOLD

REF 210018.PN | 210018.SR

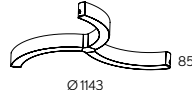

PENDANT | SURFACE
SR
PN

TRIBOLD	REF.	DIMENSION	FINISH	DIFFUSER	POWER	CRI	DOWNLIGHT *1 LUMEN			WATT K	DIMM	SKETCH
							.27	.30	.40			
	210018	.01	●	.OP	.ST	.9	4781	4969	5156	37	.DA .PU .D1	 Ø1143 85
					.HI		9563	9931	10325	74		

Reference order | 210018.XX | .SR | .PN | .XX.OP.XX.9.XX.XX

COMPONENTS

COVER KIT	REF.	FINISH
	TF17	●

Reference order | TF17 | .SR | .PN | .XX



PENDANT | SURFACE

• Select lens finishes



- ALUMINIUM PC
- 0°
- 0°
- CRI ≥90
- IK05
- IP40
- LIFE 50000H
- DIM OPTIONAL
- INTEGRATED
- ROOM
- 220-240 V 50-60 Hz
- CE

TRIBOLD

REF 210018.PN | 210018.SR

PHOTOMETRY

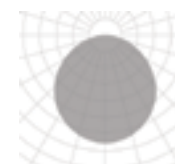

OPAL

INCLUDED (.PN)

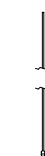

SC03.SA
WIRE 3M.

PROFILE

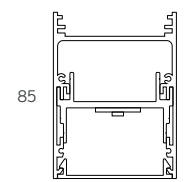

65

*1Down light (direct light) works at 500mA. La luz directa trabaja a 500mA.



FINISHES

EXTERNAL COLOR



INTERNAL COLOR



DIMENSIONS

ELECTRIC SYSTEM LENGTH mm.

843 | 1124 | 1405 | 1686 | 1967 | 2248

LIGHTING OPTIONS

DIFFUSERS

OPAL | MICROPRISMATIC

POWER

STANDARD | HIGH

CRI

90

COLOR TEMPERATURE

2700K | 3000K | 4000K | TW

DIMMABLE OPTIONS

DALI | 1.10 | PUSH

LIGHT DISTRIBUTION

DOWN | UP-DOWN

LUMINAIRE INCLUDES

.PN

1 Switch
2 x Suspension cables 3m
NON-DIM: 1 x Feed Hose 3 x 0,75mm²
DIM: 1 x Feed Hose 5 x 0,75mm²

.SR

Surface mounting kit

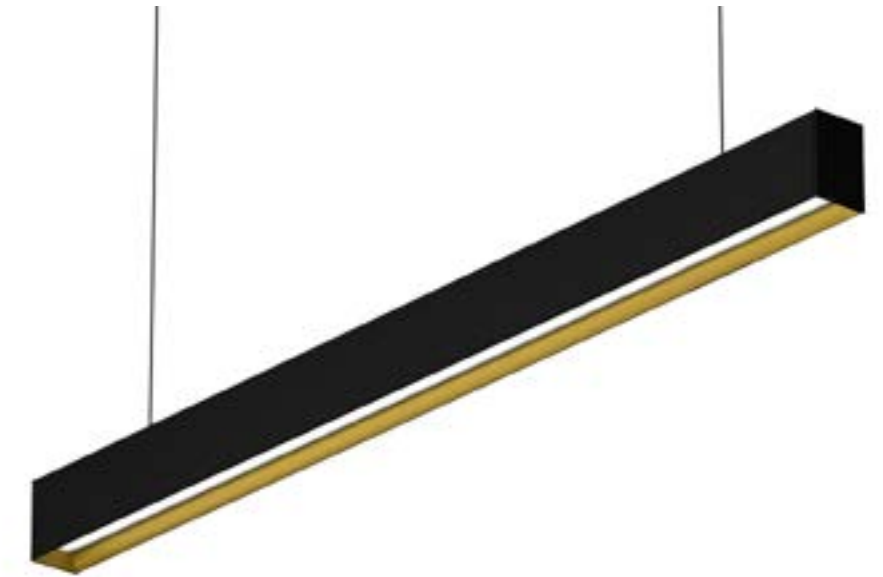

ON DEMAND

Special RAL Color
Emergency Lighting*
Motion Detection
Special Color Temperature
RGB
Thematic LED
Wireless Control Options (Casambi)
CRI 80

* Delivered separately
(not installed in luminaire).

INSTALLATIONS



WING

REF 10200.PN | 10200.SR

.PN
PENDANT

10200 WING | PN
Pag. 262

.SR
SURFACE

10200 WING | SR
Pag. 262

.RF
RECESSED FRAME

10200 WING | RF
Pag. 464

.TR
TRIMLESS

10200 WING | TR
Pag. 660

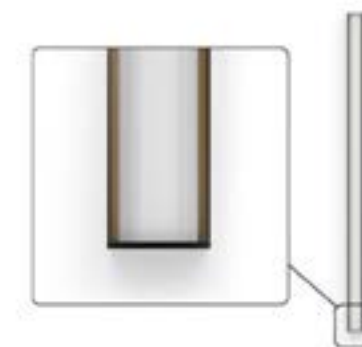

REF.	ELECTRIC SYSTEM LENGTH		FINISH	DIFFUSER	POWER	CRI	DOWNLIGHT *3 LUMEN				WATT		UPLIGHT ▲.UP *2 LUMEN			WATT		DIMM
	MM	MM					.27	.30	.40	.TW *1	K	TW	.27	.30	.40	K	K	
10200	.03	843	●	.OP .MP	.ST	.9	2295	2385	2475	5700-5910	18	38	397	405	425	4	.DA .PU .D1	
	.04	1124					3060	3180	3300	7600-7880	24	51	622	634	666	6		
	.05	1405					3825	3975	4125	9500-9850	30	64	824	840	882	8		
	.06	1686					4590	4770	4950	11400-11820	36	76	1034	1054	1107	10		
	.07	1967					5355	5565	5775	13300-13790	42	89	1243	1268	1331	12		
	.08	2248					6120	6360	6600	15200-15760	48	102	1460	1490	1564	14		

REF.	ELECTRIC SYSTEM LENGTH		FINISH	DIFFUSER	POWER	CRI	DOWNLIGHT *3 LUMEN				WATT		UPLIGHT ▲.UP *2 LUMEN			WATT		DIMM
	MM	MM					.27	.30	.40			.27	.30	.40	K	K		
10200	.03	843	●	.OP .MP	.HI	.9	4590	4767	4956	36	643	683	722	8	.DA .PU .D1			
	.04	1124					6120	6356	6608	48	1007	1069	1131	12				
	.05	1405					7650	7945	8260	60	1334	1417	1500	16				
	.06	1686					9180	9534	9912	72	1674	1777	1881	20				
	.07	1967					10710	11123	11564	84	2014	2138	2263	24				
	.08	2248					12240	12712	13216	96	2366	2512	2658	28				

Reference order | 10200.XX | .SR | .PN | .XX.XX.XX | .9.XX.XX.XX

Total length = Electric System Length + 20mm + 2x3mm (Cover kit)

Select finishes



COMPONENTS

COVER KIT	REF.	FINISH
	TF13 2x3mm.	●

Reference order | TF13 | .SR | .PN | .XX

REDUGER	REF.	POWER
	ACC.RG	.ST .HI

Reference order | ACC.RG.XX

JOINTS



OPTIONS (.PN)

SUSPENSION KIT	REF.	DIMENSION	FINISH
	SC05	5M.	.SA
	SC07	7M.	
	SC10	10M.	

Reference order | SCXX.SA

SUSPENSION ROD	REF.	DIMENSIONS	mm	FINISH
	SC21	.60	600	●
		.80	800	
		.100	1000	

Reference order | SC21.XX.XX

Not-included, please select:

CONNECTION BOX	FINISH
	●

Reference order | CB09.12.XX

PENDANT | SURFACE

WING

REF 10200.PN | 10200.SR

PHOTOMETRY

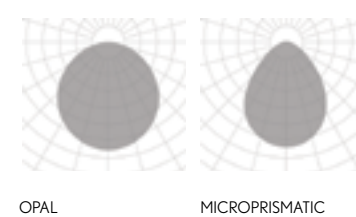

INCLUDED (.PN)

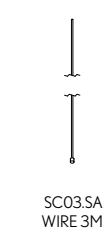

PROFILE

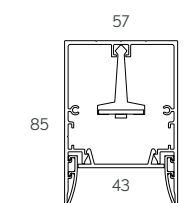

*1 Tunable White (TW) values correspond to 2700K and 6500K - TW is only available for DALI DT8 dimmable (DA), CRI 80 (8) 700mA. Los valores del blanco dinámico (TW) corresponden a 2700K y 6500K. - TW solo está disponible con protocolo DALI DT8 (DA), CRI 80 (8) 700mA.

*2 Uplight (UP) is only available for ON-OFF and DALI dimmable (DA) options, both in 24VdC. - UP luminaires carry the same color temperature above and below (up-down).

La luz indirecta está solo disponible para versiones on-off y regulación DALI (DA), ambas en 24VdC. - Las luminarias UP llevan la misma temperatura de color arriba y abajo (arriba-abajo).

*3 Down light (direct light) works at 500mA. La luz directa trabaja a 500mA.



FINISHES

● COLORS



DIMENSIONS

◆ ELECTRIC SYSTEM LENGTH mm.

843 | 1124 | 1405 | 1686 | 1967 | 2248

LIGHTING OPTIONS

■ DIFFUSERS

OPAL | MICROPRISMATIC

POWER

STANDARD | HIGH

CRI

90

COLOR TEMPERATURE

2700K | 3000K | 4000K | TW

▼ DIMMABLE OPTIONS

DALI | 1.10 | PUSH

▲ LIGHT DISTRIBUTION

DOWN

LUMINAIRE INCLUDES

1 Switch
 2 x Suspension cables 3m
 NON-DIM: 1 x Feed Hose 3 x 0,75mm²
 DIM: 1 x Feed Hose 5 x 0,75mm²

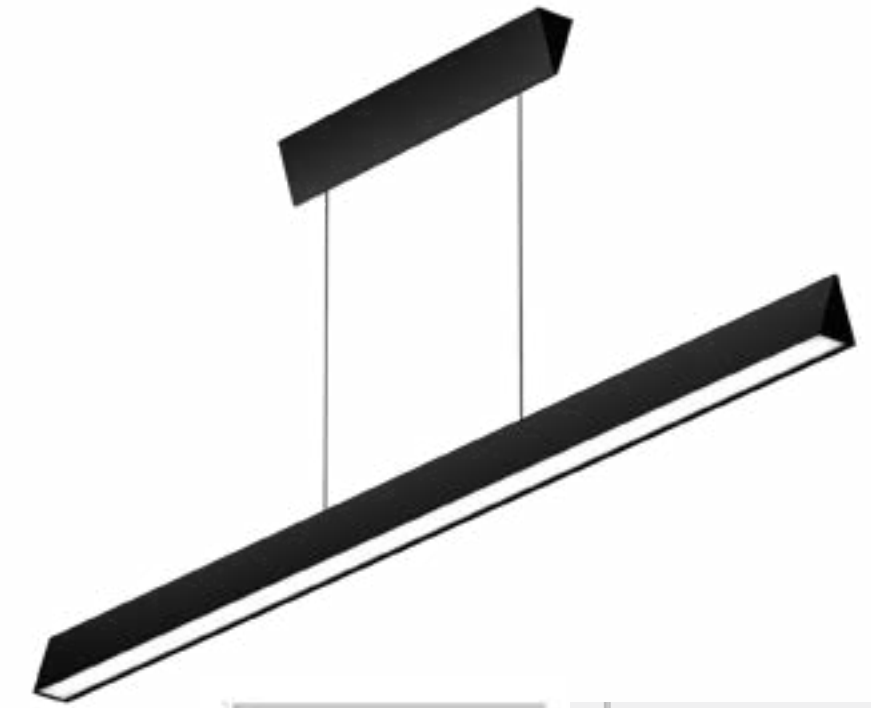

ON DEMAND

Emergency Lighting *
 Motion Detection
 Special Color Temperature
 RGB
 Thematic LED
 Wireless Control Options (Casambi)
 CRI 80

* Delivered separately
 (not installed in luminaire).

INSTALLATIONS

.PN
 PENDANT

·10169 ALZIRA | PN
 Pag. 266

.WS
 WALL SURFACE

·10169 ALZIRA | WS
 Pag. 798



ALZIRA

REF 10169.PN

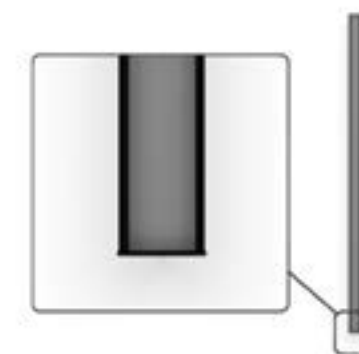

PENDANT

.PN

REF.	ELECTRIC SYSTEM LENGTH		FINISH	DIFFUSER	POWER	CRI	DOWNLIGHT *2 LUMEN				WATT		DIMM
	MM	MM					.27	.30	.40	.TW *1	K	TW	
10169	.03	843	●	.OP .MP	.ST	.9	2295	2385	2475	5700-5910	18	38	.DA .PU .D1
	.04	1124					3060	3180	3300	7600-7880	24	51	
	.05	1405					3825	3975	4125	9500-9850	30	64	
	.06	1686					4590	4770	4950	11400-11820	36	76	
	.07	1967					5355	5565	5775	13300-13790	42	89	
	.08	2248					6120	6360	6600	15200-15760	48	102	

REF.	ELECTRIC SYSTEM LENGTH		FINISH	DIFFUSER	POWER	CRI	DOWNLIGHT *2 LUMEN			WATT	DIMM
	MM	MM					.27	.30	.40		
10169	.03	843	●	.OP .MP	.HI	.9	4590	4767	4956	36	.DA .PU .D1
	.04	1124					6120	6356	6608	48	
	.05	1405					7650	7945	8260	60	
	.06	1686					9180	9534	9912	72	
	.07	1967					10710	11123	11564	84	
	.08	2248					12240	12712	13216	96	

Reference order | 10169.XX.PN.XX.XX.XX.9.XX.XX

COMPONENTS

COVER KIT	REF.	FINISH
	TF14	●
	2x3mm.	

Reference order | TF14.PN.XX

Total length = Electric System Length + 20mm + 2x3mm (Cover kit)

Select finishes

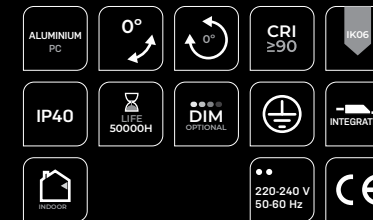

ALZIRA

REF 10169.PN

PHOTOMETRY

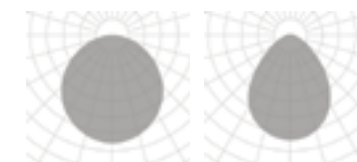

OPAL MICROPRISMATIC

INCLUDED (.PN)

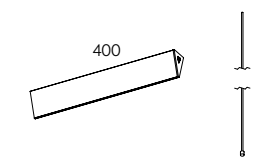

CONNECTION BOX SC03.SA WIRE 3M.

PROFILE

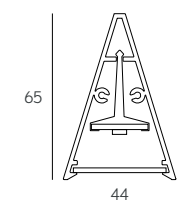

*1 Tunable White (TW) values correspond to 2700K and 6500K - TW is only available for DALI DT8 dimmable (.DA), CRI 80 (.8) 700mA. Los valores del blanco dinámico (TW) corresponden a 2700K y 6500K. - TW solo está disponible con protocolo DALI DT8 (.DA), CRI 80 (.8) 700mA.
*2 Down light (direct light) works at 500mA. La luz directa trabaja a 500mA.

PENDANT



ACOUSTIC

SYSTEM

Sustainability, acoustics & lighting in one solution

Pleasing lighting and sound solutions. Everything in perfect harmony. That's BPM Acoustic, an innovative response to specific lighting for noisy areas and when peace and quiet are essential. BPM Acoustic also features avant-garde panel design, with a hidden lighting solution to achieve a quiet environment in an unobtrusive way. And another plus point is sustainability.

Sostenibilidad, acústica e iluminación en una solución

Soluciones lumínicas, acústicas y estéticas. Todo a la vez, y todo en armonía. Así es BPM Acoustic, una respuesta innovadora a necesidades específicas de iluminación en espacios de gran carga sonora o donde se requiere de un ambiente de silencio.

BPM Acoustic es además una propuesta vanguardista en cuanto a diseño de panel, con una solución de iluminación oculta para incidir en el concepto de discreción y tranquilidad con el valor incorporado de la sostenibilidad.

 **BPM**Lighting®

Let's get brighter

new

FINISHES

ACOUSTIC COLORS



PROFILE COLORS



DIMENSIONS

LENGTHS mm.

1200

LIGHTING OPTIONS

DIFFUSERS

OPAL

MICROPRISMATIC

POWER

STANDARD

CRI

90

COLOR TEMPERATURE

2700K | 3000K | 4000K

DIMMABLE OPTIONS

DALI

1.10

PUSH

LIGHT DISTRIBUTION

DOWN

LUMINAIRE INCLUDES

2 x Suspension cables 3m
NON-DIM DOWN or DIM DOWN: 1 x Feed Hose 3 x 0,75mm²
Connection Box (CB09.32)
Cover Kit
Diffuser

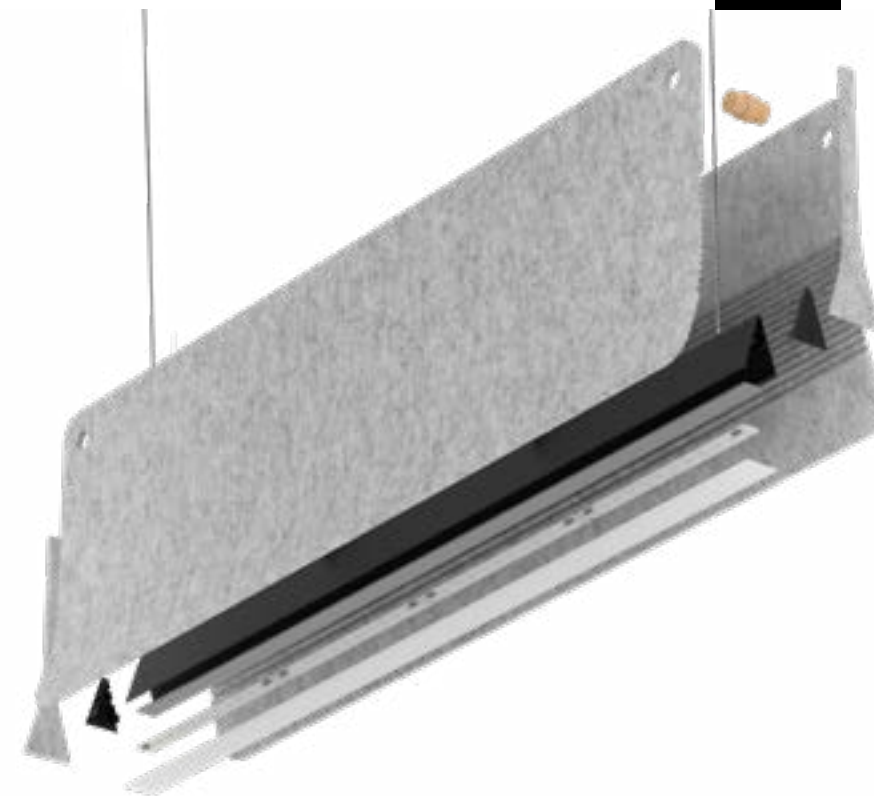

ON DEMAND

Emergency Lighting*
Motion Detection
Well-Certified LED Boards
Special Color Temperature
RGB
TW
Thematic LED
Wireless Control Options (Casambi)
CRI 80

* Delivered separately
(not installed in luminaire).



ACOUSTIC ALZIRA

Designed by Rafa Ortega

REF 230002.PN

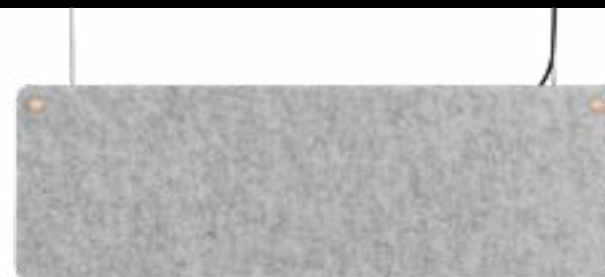

Designed by Rafa Ortega, this model belongs to Papyrus collection, a selection of luminaires that give shape and style to your decorative schemes while providing sustainable sound insulation in the room.

Diseñado por Rafa Ortega, este modelo pertenece a la colección Papyrus, una colección que da forma y estilo a tus esquemas decorativos a la vez que proporciona un aislamiento acústico sostenible en la estancia.

PENDANT

.PN



REF.	DIMENSION ●	FINISH ●		DIFFUSER ■	POWER	CRI	DOWNLIGHT * LUMEN			WATT K	DIMM ▼
		.27	.30				.40				
230002	.01 1200mm	.50 .51	WH BK	.OP .MP	.ST	.9	3060	3180	3300	24	.DA .PU .D1

Reference order | 230002.01.PN.XX.XX.XX.XX.9.XX.XX

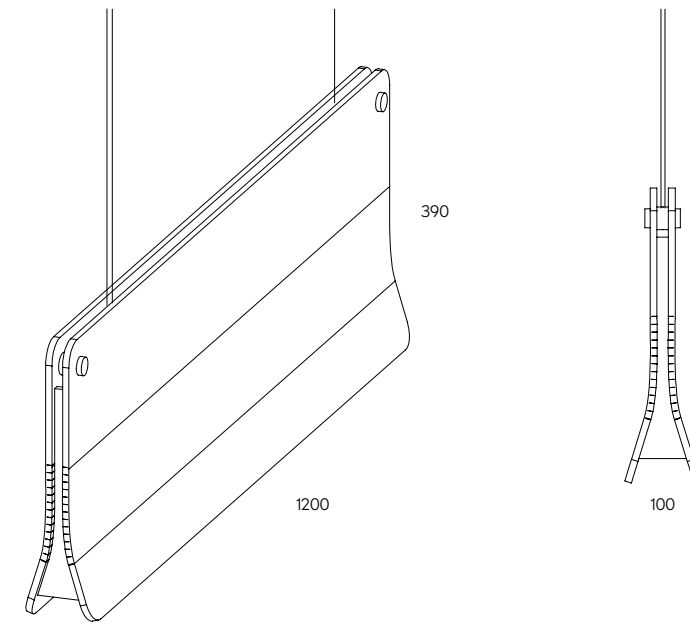

* Down light (direct light) works at 500mA. La luz directa trabaja a 500mA.

● Select Acoustic finishes

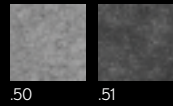

● Select Profile finishes

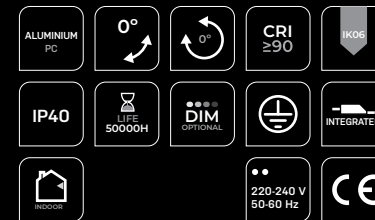
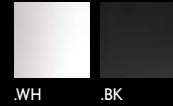

ACOUSTIC ALZIRA

Designed by Rafa Ortega

REF 230002.PN

ACOUSTIC PROPERTIES

- ENVIRONMENTAL:**
- FIRE TEST:**
- BAFFLE THICKNESS:**
- BABBLE DENSITY:**
- SOUND ABSORPTION COEFFICIENT:**

Comply with the requirements detailed in the BREEAM International, BREEAM-NOR v6.0 and LEED v4.1. Standards
 Classification B-s1, d0 and CTEDB-SI Compliant
 9mm
 155Kg/m³
 0,77 α_w

PHOTOMETRY

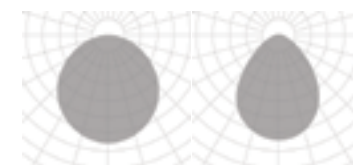

OPAL MICROPRISMATIC

INCLUDED

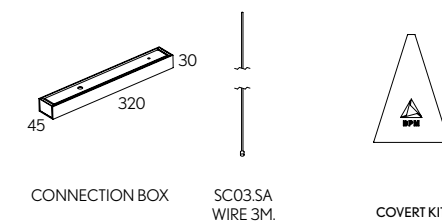

PROFILE

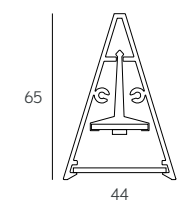

PENDANT

.PN

new



FINISHES

ACOUSTIC COLORS



PROFILE COLORS



DIMENSIONS

LENGTHS mm.

1200

LIGHTING OPTIONS

DIFFUSERS

OPAL

MICROPRISMATIC

POWER

STANDARD

CRI

90

COLOR TEMPERATURE

2700K | 3000K | 4000K

DIMMABLE OPTIONS

DALI

1.10

PUSH

LIGHT DISTRIBUTION

DOWN

LUMINAIRE INCLUDES

.PN

2 x Suspension cables 3m

NON-DIM DOWN: 1 x Feed Hose 3 x 0,75mm²

DIM DOWN: 1 x Feed Hose 5 x 0,75mm²

Diffuser - Cover Kit

Connection Box CB09:12

.SR

Surface mounting kit

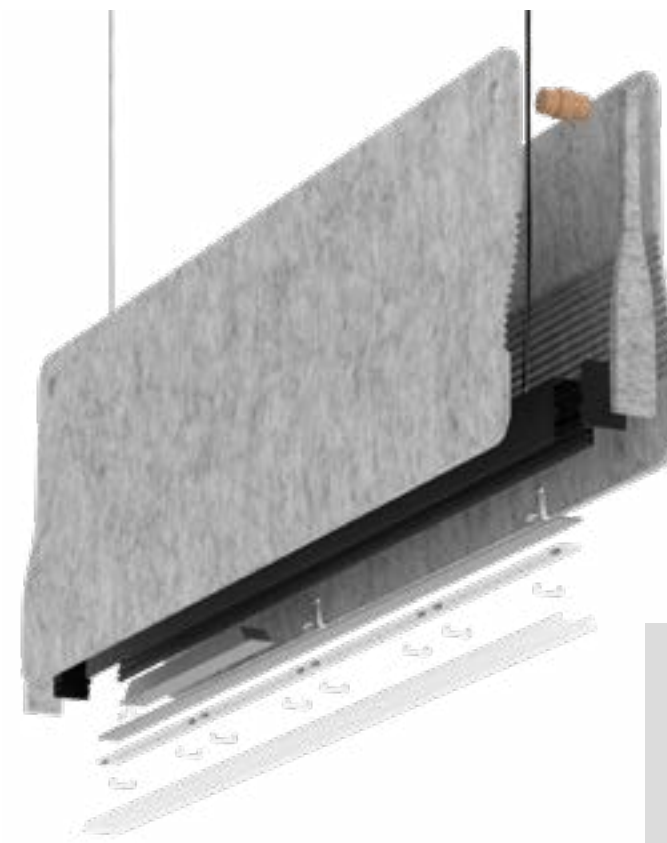

ON DEMAND

Emergency Lighting*

Motion Detection

Well-Certified LED Boards

Special Color Temperature

RGB

TW

Thematic LED

Wireless Control Options (Casambi)

CRI 80

* Delivered separately
(not installed in luminaire).



ACOUSTIC ALBA

Designed by Rafa Ortega

REF 230004.PN | 230004.SR

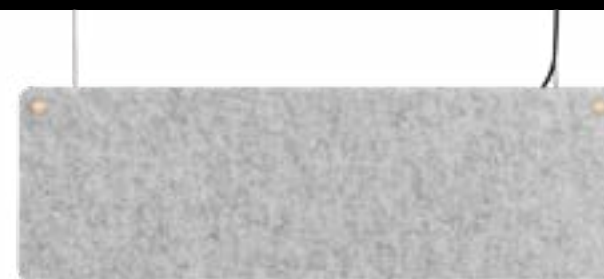

Designed by Rafa Ortega, this model belongs to Papyrus collection, a selection of luminaires that give shape and style to your decorative schemes while providing sustainable sound insulation in the room.

Diseñado por Rafa Ortega, este modelo pertenece a la colección Papyrus, una colección que da forma y estilo a tus esquemas decorativos a la vez que proporciona un aislamiento acústico sostenible en la estancia.



REF.	DIMENSION ●	FINISH		DIFFUSER ■	POWER	CRI	DOWNLIGHT * LUMEN			WATT	DIMM ▼
		●	●				.27	.30	.40		
230004	.01 1200mm	.50 .51	WH BK	.OP .MP	.ST	.9	3060	3180	3300	24	.DA .PU .D1

Reference order | ▲ .SR | ● .PN | ■ .XX-XX.XX | ▼ .ST9.XX.XX

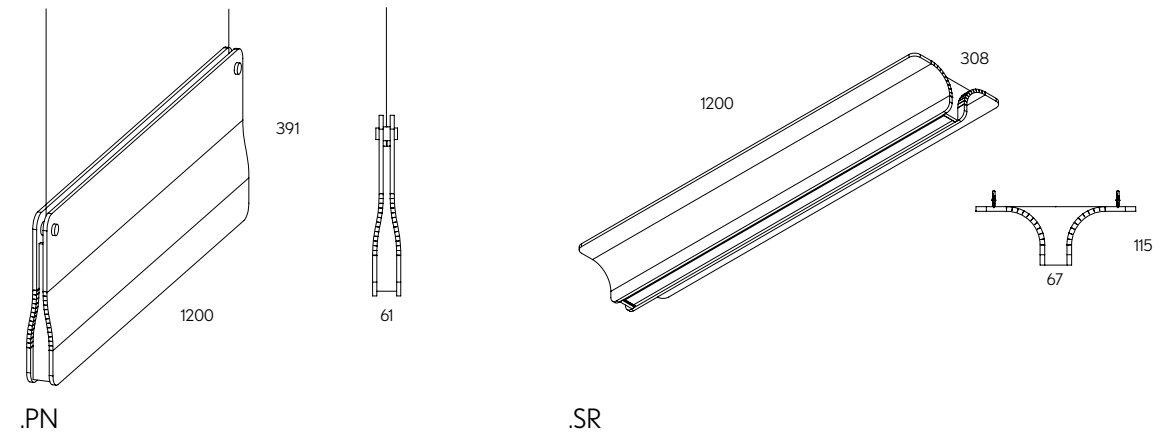

* Down light (direct light) works at 500mA. La luz directa trabaja a 500mA.

● Select Acoustic finishes

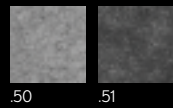

● Select Profile finishes

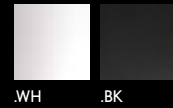

- ALUMINIUM PC
- 0°
- 0°
- CRI ≥90
- IK05
- IP40
- LIFE 50000H
- DIM OPTIONAL
- INTEGRATED
- INDOOR
- 220-240 V 50-60 Hz
- CE

ACOUSTIC ALBA

Designed by Rafa Ortega

REF 230004.PN | 230004.SR

PENDANT | SURFACE

ACOUSTIC PROPERTIES

- ENVIRONMENTAL:**
- FIRE TEST:**
- BAFFLE THICKNESS:**
- BABBLE DENSITY:**
- SOUND ABSORPTION COEFFICIENT:**

Comply with the requirements detailed in the BREEAM International, BREEAM-NOR v6.0 and LEED v4.1 Standards

Classification B-s1, d0 and CTEDB-SI Compliant

12 mm

190Kg/m³

0,92 α_w

PHOTOMETRY

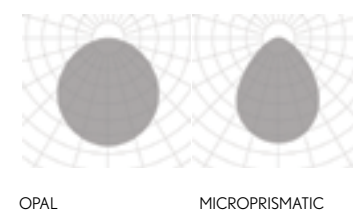

INCLUDED

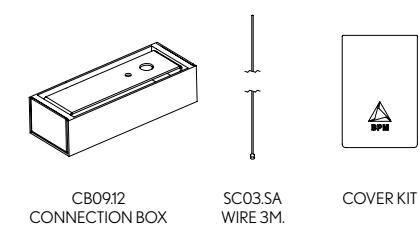

PROFILE

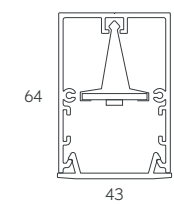

new

FINISHES

● ACOUSTIC COLORS



● PROFILE COLORS



DIMENSIONS

● LENGTHS mm.

1163

LIGHTING OPTIONS

■ DIFFUSERS

OPAL

MICROPRISMATIC

POWER

STANDARD

CRI

90

COLOR TEMPERATURE

2700K | 3000K | 4000K

▼ DIMMABLE OPTIONS

DALI

1.10

PUSH

▲ LIGHT DISTRIBUTION

DOWN

LUMINAIRE INCLUDES

2 x Suspension cables 3m
NON-DIM DOWN or DIM DOWN: 1 x Feed Hose 3 x 0,75mm²
Diffuser
Cover Kit
Connection Box (CB09.32)

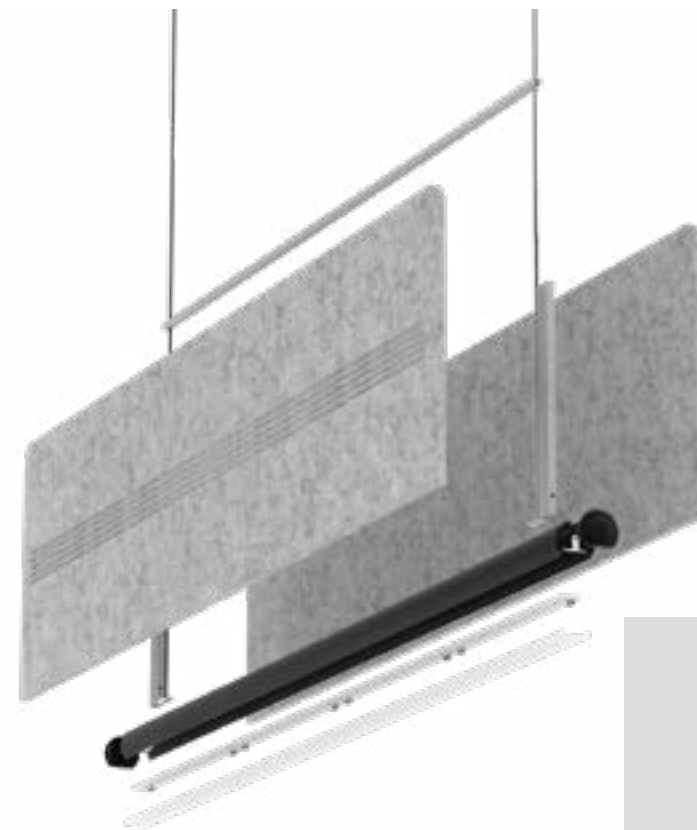

ON DEMAND

Emergency Lighting*
Motion Detection
Well-Certified LED Boards
Special Color Temperature
RGB
TW
Thematic LED
Wireless Control Options (Casambi)
CRI 80

* Delivered separately
(not installed in luminaire).

PENDANT



ACOUSTIC LINGGO MINI

REF 230007.PN

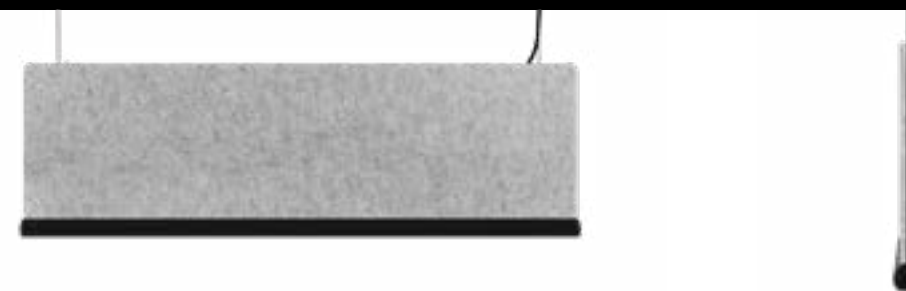



REF.	DIMENSION ●	FINISH ●		DIFFUSER ■	POWER	CRI	DOWNLIGHT * LUMEN			WATT K	DIMM ▼
		.27	.30				.40				
230007	.01 1163mm	.50 .51	WH BK	.OP .MP	.ST	.9	3060	3180	3300	24	.DA .PU .D1

Reference order | 230007.01.PN.XX-XX.XX.ST9.XX.XX

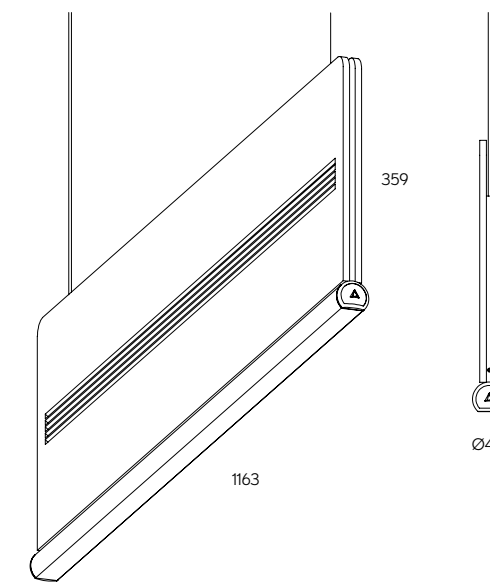

* Down light (direct light) works at 500mA. La luz directa trabaja a 500mA.

● Select Acoustic finishes

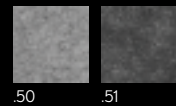

● Select Profile finishes

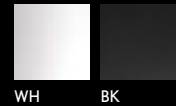

- ALUMINIUM PC
- 0°
- 0°
- CRI ≥90
- IP40
- LIFE 50000H
- DIM OPTIONAL
- INTEGRATED
- 220-240 V 50-60 Hz
- CE

ACOUSTIC LINGGO MINI

REF 230007.PN

ACOUSTIC PROPERTIES

- ENVIRONMENTAL:**
- FIRE TEST:**
- BAFFLE THICKNESS:**
- BABBLE DENSITY:**
- SOUND ABSORPTION COEFFICIENT:**

Comply with the requirements detailed in the BREEAM International, BREEAM-NOR v6.0 and LEED v4.1. Standards
 Classification B-s1, d0 and CTEDB-SI Compliant
 9mm
 155Kg/m³
 0,77 αw

PHOTOMETRY

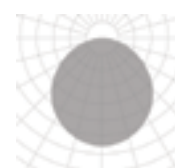

OPAL

INCLUDED

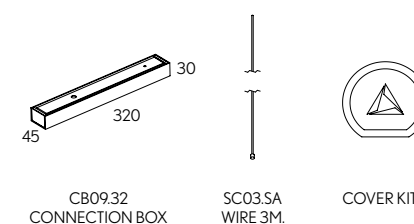

PROFILE

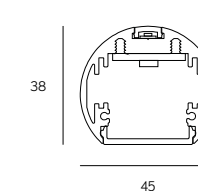

PENDANT .PN



FINISHES

● ACOUSTIC COLORS



● PROFILE COLORS



DIMENSIONS

● LENGTHS mm.

1170

LIGHTING OPTIONS

■ DIFFUSERS

OPAL | MICROPRISMATIC

POWER

STANDARD

CRI

90

COLOR TEMPERATURE

2700K | 3000K | 4000K

▼ DIMMABLE OPTIONS

DALI | 1.10 | PUSH

▲ LIGHT DISTRIBUTION

DOWN

LUMINAIRE INCLUDES

.PN

- 2 x Suspension cables 3m
- NON-DIM DOWN: 1 x Feed Hose 3 x 0,75mm²
- DIM DOWN: 1 x Feed Hose 5 x 0,75mm²
- Diffuser
- Cover Kit
- Connection Box CB09:12

.SR

- Surface mouting kit

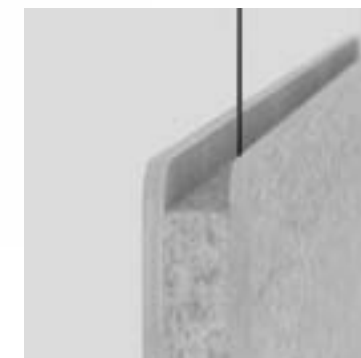
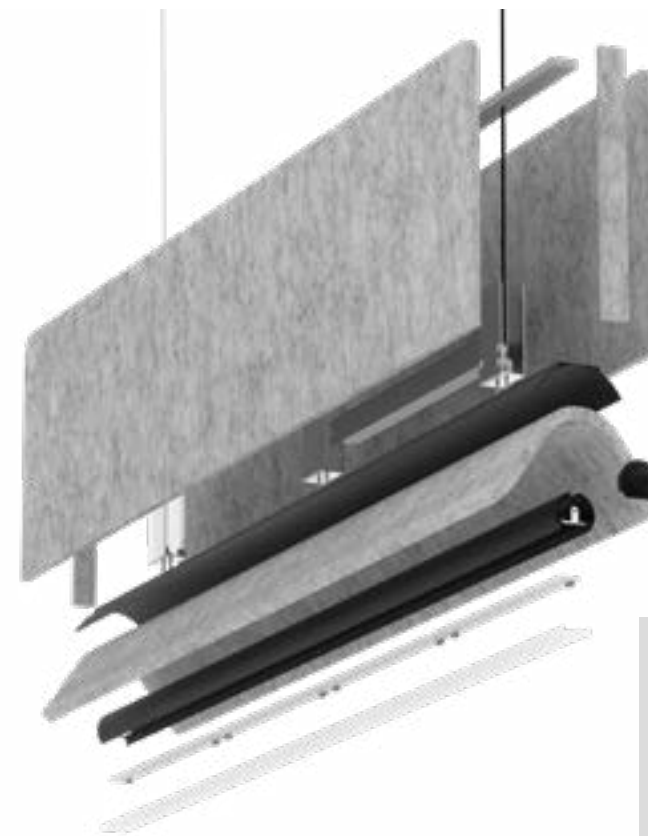

ON DEMAND

- Emergency Lighting*
- Motion Detection
- Well-Certified LED Boards
- Special Color Temperature
- RGB
- TW
- Thematic LED
- Wireless Control Options (Casambi)
- CRI 80

* Delivered separately (not installed in luminaire).

PENDANT | SURFACE
SR
PN

- ALUMINIUM PC
- 0°
- 0°
- CRI ≥ 90
- IK08
- IP40
- LIFE 50000H
- DIM OPTIONAL
- INTEGRATED
- ROOM
- 220-240 V 50-60 Hz
- CE

ACOUSTIC LAMBDA

REF 230001.PN | 230001.SR





REF.	DIMENSION ●	FINISH ●		DIFFUSER ■	POWER	CRI	DOWNLIGHT * LUMEN			WATT	DIMM ▼
							.27	.30	.40		
230001	.01 1170mm	.50 .51 .52	WH BK	.OP .MP	.ST	.9	3060	3180	3300	24	.DA .PU .D1

Reference order | 230001.01 | .SR | .PN | .XX-XX.XX.ST9.XX.XX

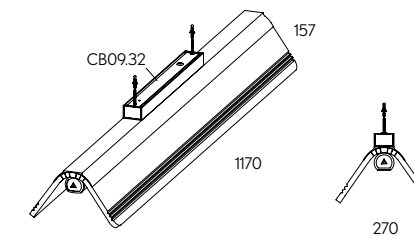
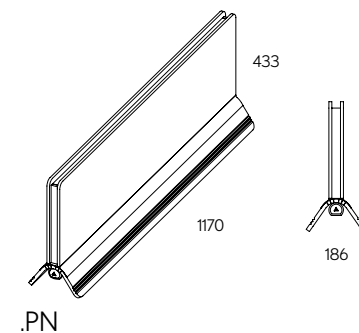

.PN

.SR

* Down light (direct light) works at 500mA. La luz directa trabaja a 500mA.

Select Acoustic finishes

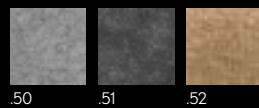

Select Profile finishes

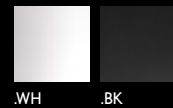

ACOUSTIC LAMBDA

REF 230001.PN | 230001.SR

ACOUSTIC PROPERTIES

- ENVIRONMENTAL:**
- FIRE TEST:**
- BAFFLE THICKNESS:**
- BAFFLE DENSITY:**
- SOUND ABSORPTION COEFFICIENT:**

Comply with the requirements detailed in the BREEAM International, BREEAM-NOR v6.0 and LEED v4.1 Standards
 Classification B-s1, d0 and CTEDB-SI Compliant
 9mm
 155Kg/m³
 0,77 α_w

INCLUDED (.SR)

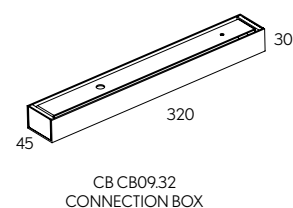

CB CB09.32 CONNECTION BOX

PHOTOMETRY

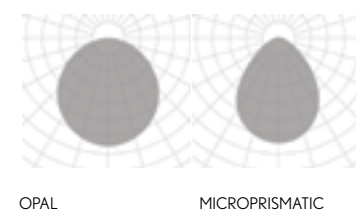

OPAL

MICROPRISMATIC

INCLUDED (.PN)

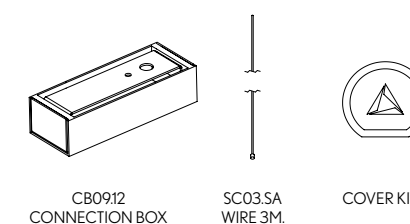

CB09.12 CONNECTION BOX

SC03.SA WIRE 3M.

COVER KIT

PROFILE

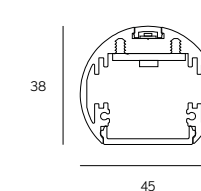

38

45

PENDANT | SURFACE

.SR

.PN



FINISHES

ACOUSTIC COLORS



PROFILE COLORS



DIMENSIONS

LENGTHS mm.

1190

LIGHTING OPTIONS

DIFFUSERS

OPAL

MICROPRISMATIC

POWER

STANDARD

CRI

90

COLOR TEMPERATURE

2700K | 3000K | 4000K

DIMMABLE OPTIONS

DALI

1.10

PUSH

LIGHT DISTRIBUTION

DOWN

LUMINAIRE INCLUDES

2 x Suspension cables 3m
 NON-DIM DOWN: 1 x Feed Hose 3 x 0,75mm²
 DIM DOWN: 1 x Feed Hose 5 x 0,75mm²
 Diffuser
 Cover Kit
 Connection Box CB09:12

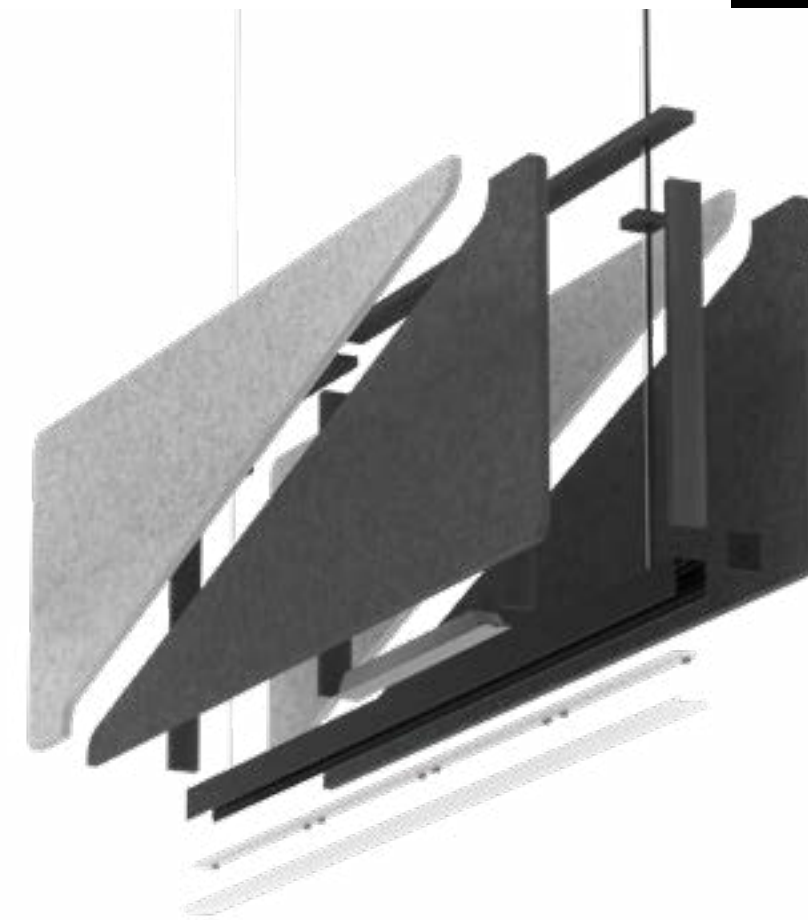

ON DEMAND

Emergency Lighting*
 Motion Detection
 Well-Certified LED Boards
 Special Color Temperature
 RGB
 TW
 Thematic LED
 Wireless Control Options (Casambi)
 CRI 80

* Delivered separately
 (not installed in luminaire).

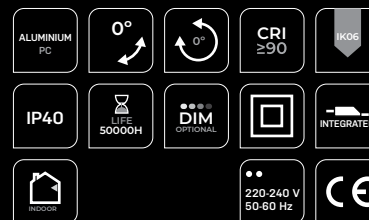

ACOUSTIC ALBA MINI

REF 230008.PN





REF.	DIMENSION ●	FINISH			DIFFUSER ■	POWER	CRI	DOWNLIGHT * LUMEN			WATT	DIMM ▼	
		.50-51	.53-54	.50-53				.27	.30	.40			
230008	.01 1190mm	.50-51	.53-54	.50-53	WH BK	.OP .MP	.ST	.9	3060	3180	3300	24	.DA .PU .D1

Reference order | 230008.01.PN.XX-XX.XX.ST9.XX.XX

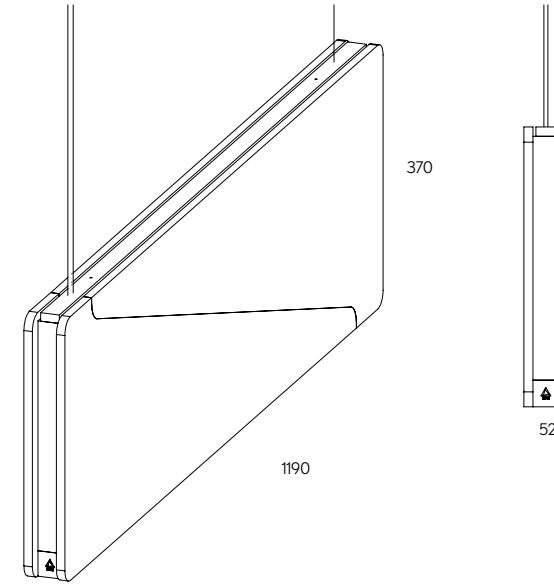

* Down light (direct light) works at 500mA. La luz directa trabaja a 500mA.

● Select acoustic finishes



● Select profile finishes

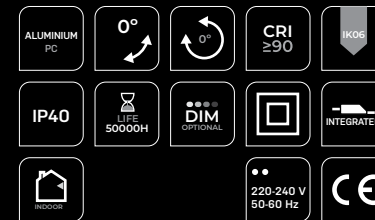
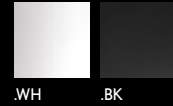

ACOUSTIC ALBA MINI

REF 230008.PN

ACOUSTIC PROPERTIES

- ENVIRONMENTAL:**
- FIRE TEST:**
- BAFFLE THICKNESS:**
- BABBLE DENSITY:**
- SOUND ABSORPTION COEFFICIENT:**

Comply with the requirements detailed in the BREEAM International, BREEAM-NOR v6.0 and LEED v4.1 Standards
 Classification B-s1, d0 and CTEDB-SI Compliant
 9 mm
 190Kg/m³
 0,92 α_w

PHOTOMETRY

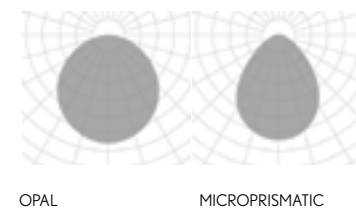

INCLUDED

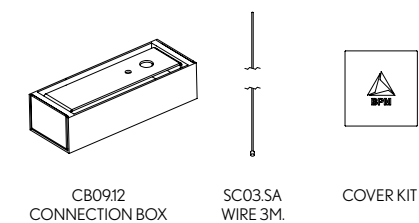

PROFILE

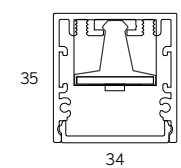

PENDANT

.PN

new



FINISHES

ACOUSTIC COLORS



PROFILE COLORS



DIMENSIONS

LENGTHS MM.

1190

COMPONENTS

SLIM PATRICIA
SLIM LED BALL
SLIM TUBE
SLIM WALL WASHER
SLIM LENSES
SLIM MOTION LENSES
SLIM LED MODULES

POWER

STANDARD

CRI

90

COLOR TEMPERATURE

2700K | 3000K | 4000K

▼ DIMMABLE OPTIONS

DALI | 1.10

▲ LIGHT DISTRIBUTION

DOWN

LUMINAIRE INCLUDES

Suspension cables
NON-DIM DOWN: 1x Feed Hose 3 x 0,75mm²
DIM DOWN: 1x Feed Hose 5 x 0,75mm²
Cover Kit
Connection Box CB09.12

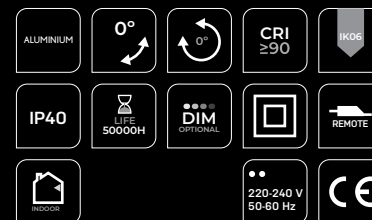
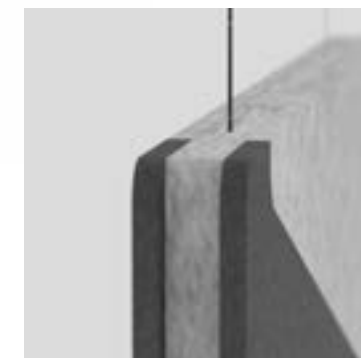
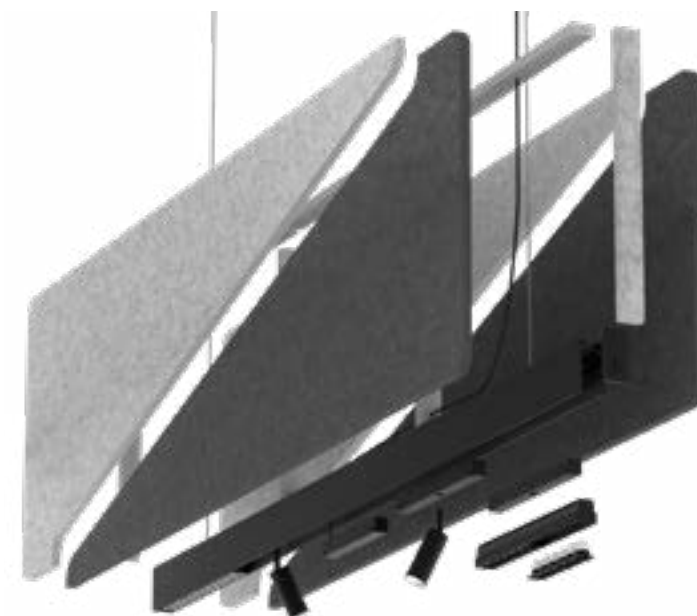

ACOUSTIC ALARIK SLIM

REF 230009.PN

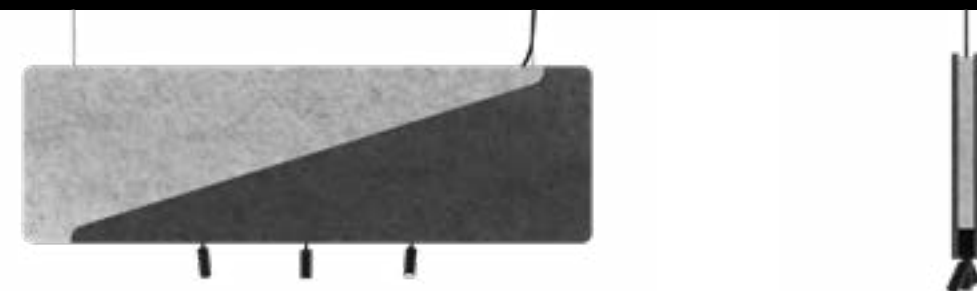

.PN

PENDANT

ALARIK SLIM	REF.	DIMENSION	FINISH	SKETCH	48V TRANSFORMER	DIMENSION	WATT	POWER FEEDER UNIT	FINISH
	230009	.01 1190mm.	●		DR48	.01	75		.BK-BK .WH-WH

Reference order | 230009.XX.PN.XX-XX-XX

Reference order | DR48.XX

ACC230009.CA.XX

SLIM PATRICIA	REF.	DIMENSION	FINISH	OPTIC OPTIONS	POWER	CRI	K	LUMEN	WATT	VdC	DIMM	SKETCH
	11544	.01	●	.15 .38 .60	.ST	.9	.27	576	8	48	.DA .D1	
							.30	607				
							.40	695				
	11544	.02	●	.15 .38 .60	.ST	.9	.27	1173	15	48	.DA .D1	
							.30	1181				
							.40	1207				

Reference order | 11544.XX.XX.XX.ST9.XX.XX

SLIM PATRICIA ZOOM	REF.	DIMENSION	FINISH	OPTIC OPTIONS	POWER	CRI	K	LUMEN	WATT	VdC	DIMM	SKETCH
	11546	.01	●	.15-36 .36-60	.ST	.9	.27	2038	25	48	.DA .D1	
							.30	2254				
							.40	2320				

Reference order | 11546.01.XX.XX.ST9.XX.XX

SLIM LED BALL	REF.	DIMENSION	FINISH	OPTIC OPTIONS	POWER	CRI	K	LUMEN	WATT	VdC	DIMM	SKETCH
	11551	.01	●	.37	.ST	.9	.27	355	8	48	.DA .D1	
							.30	357				
							.40	396				

Reference order | 11551.01.XX.XX.ST9.XX.XX

SLIM LED TUBE 20	REF.	DIMENSION	FINISH	OPTIC OPTIONS	POWER	CRI	K	LUMEN	WATT	VdC	DIMM	SKETCH
	11553	.01	●	.20 .40	.ST	.9	.27	174	3	48	.DA .D1	
							.30	187				
							.40	212				

Reference order | 11553.01.XX.XX.ST9.XX.XX

SLIM LED TUBE 40	REF.	DIMENSION	FINISH	OPTIC OPTIONS	POWER	CRI	K	LUMEN	WATT	VdC	DIMM	SKETCH
	11552	.01	●	.20 .40	.ST	.9	.27	808	14	48	.DA .D1	
							.30	820				
							.40	881				

Reference order | 11552.01.XX.XX.ST9.XX.XX

SLIM WALL WASHER	REF.	DIMENSION	FINISH	OPTIC OPTIONS	POWER	CRI	K	LUMEN	WATT	VdC	DIMM	SKETCH
	11550	.01	.BK-BK	-	.ST	.9	.27	882	15	48	.DA .D1	
							.30	1013				
							.40	1107				

Reference order | 11550.01.XX.XX.ST9.XX.XX

SLIM LENSES	REF.	DIMENSION	FINISH	OPTIC OPTIONS	POWER	CRI	K	LUMEN	WATT	VdC	DIMM	SKETCH
	11548	.01	.BK-BK	.15 .38	.ST	.9	.27	660	8	48	.DA .D1	
							.30	750				
							.40	827				
	11548	.02	.BK-BK	.15 .38	.ST	.9	.27	1320	15	48	.DA .D1	
							.30	1511				
							.40	1654				

Reference order | 11548.XX.XX.XX.ST9.XX.XX

● Select Acoustic finishes

● Select Profile finishes

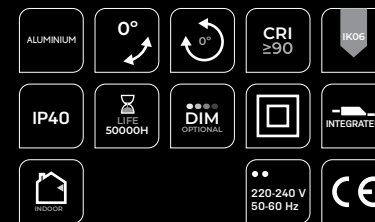
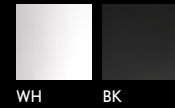

ACOUSTIC ALARIK SLIM

REF 230009.PN

PHOTOMETRY

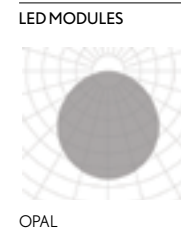
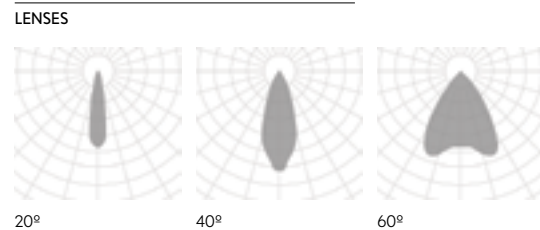
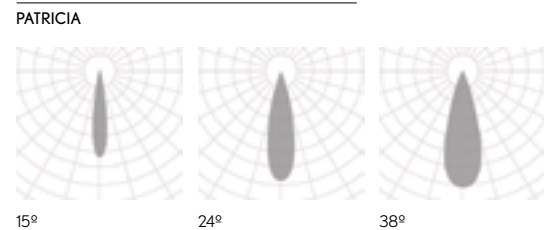

INCLUDED

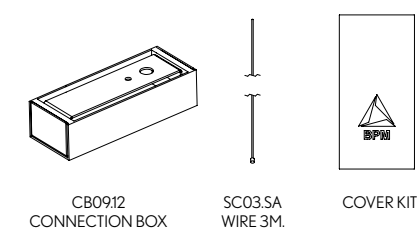

PROFILE

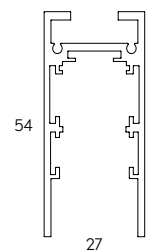



SLIM MOTION LENSES	REF.	DIMENSION	FINISH	OPTIC OPTIONS	POWER	CRI	K	LUMEN	WATT	VaC	DIMM	SKETCH
	11547	.01	.BK-BK	.15 .38	.ST	.9	.27	660	8	48	.DA .D1	
							.30	750				
							.40	827				

Reference order | 11547.01.XX.XX.ST9.XX.XX

SLIM LED MODULES	REF.	DIMENSION	FINISH	DIFFUSER	POWER	CRI	K	LUMEN	WATT	VaC	DIMM	SKETCH
	11549	.01	.BK-BK	.OP	.ST	.9	.27	558	9	48	.DA .D1	
							.30	560				
							.40	604				
	11549	.02	.BK-BK	.OP	.ST	.9	.27	1115	18	48	.DA .D1	
							.30	1120				
							.40	1208				
	11549	.03	.BK-BK	.OP	.ST	.9	.27	1670	24	48	.DA .D1	
							.30	1680				
							.40	1812				

Reference order | 11549.XX.XX.XX.ST9.XX.XX

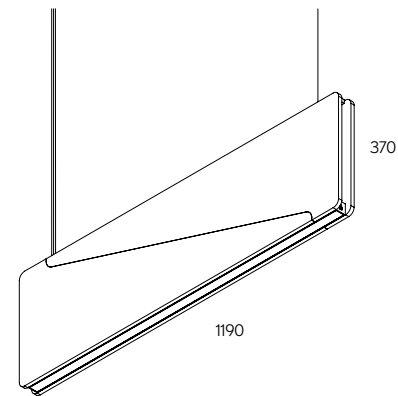

- Select Acoustic finishes
- Select Profile finishes

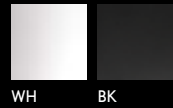

- ALUMINIUM
- 0°
- 0°
- CRI ≥90
- IK05
- IP40
- LIFE 50000H
- DIM OPTIONAL
- INTEGRATED
- ROOM
- 48V REMOTE
- 220-240 V 50-60 Hz
- CE

ACOUSTIC ALARIK SLIM

REF 230009.PN

ACOUSTIC PROPERTIES

- ENVIRONMENTAL:**
- FIRE TEST:**
- BAFFLE THICKNESS:**
- BABBLE DENSITY:**
- SOUND ABSORPTION COEFFICIENT:**

Comply with the requirements detailed in the BREEAM International, BREEAM-NOR v6.0 and LEED v4.1 Standards
 Classification B-s1, d0 and CTEDB-SI Compliant
 9mm
 190 Kg/m³
 0,92 αw

PHOTOMETRY

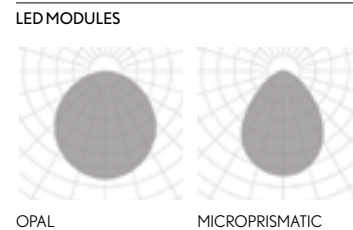

INCLUDED

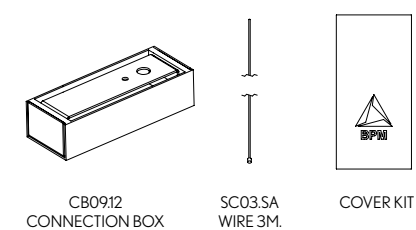

PROFILE

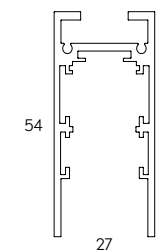

new

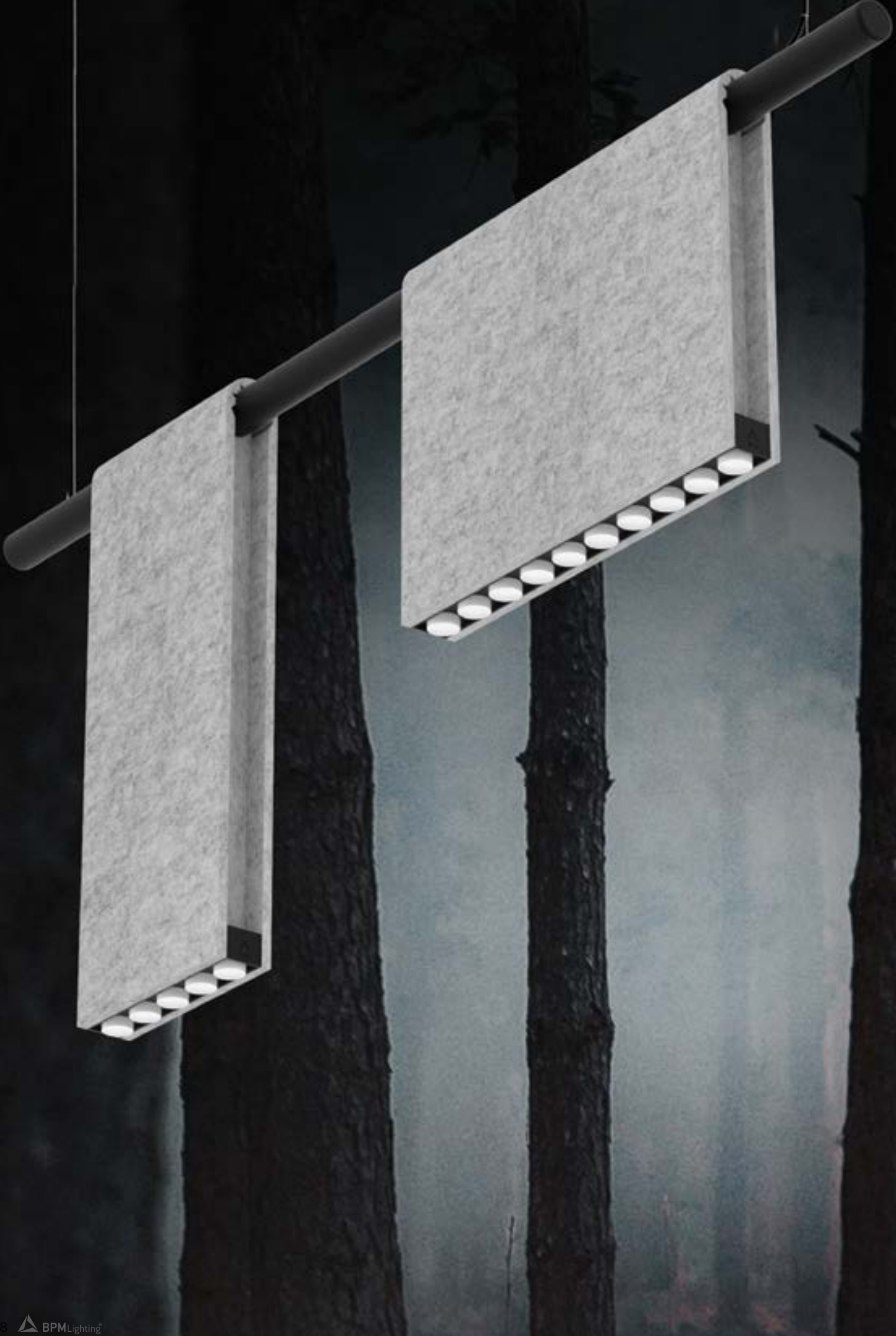

FINISHES

● PROFILE COLORS



● LED MODULE COLORS

ACOUSTIC COLORS



LED MODULE COLORS



DIMENSIONS

● LENGTHS mm.

1000

LIGHTING OPTIONS

■ BEAM OPTIONS

20° | 40° | 60°

POWER

STANDARD

CRI

90

COLOR TEMPERATURE

2700K | 3000K | 4000K

▼ DIMMABLE OPTIONS

DALI | 1.10 |

▲ LIGHT DISTRIBUTION

DOWN

LUMINAIRE INCLUDES

2 x Suspension cables 3m
Connection Box
Cover Kit

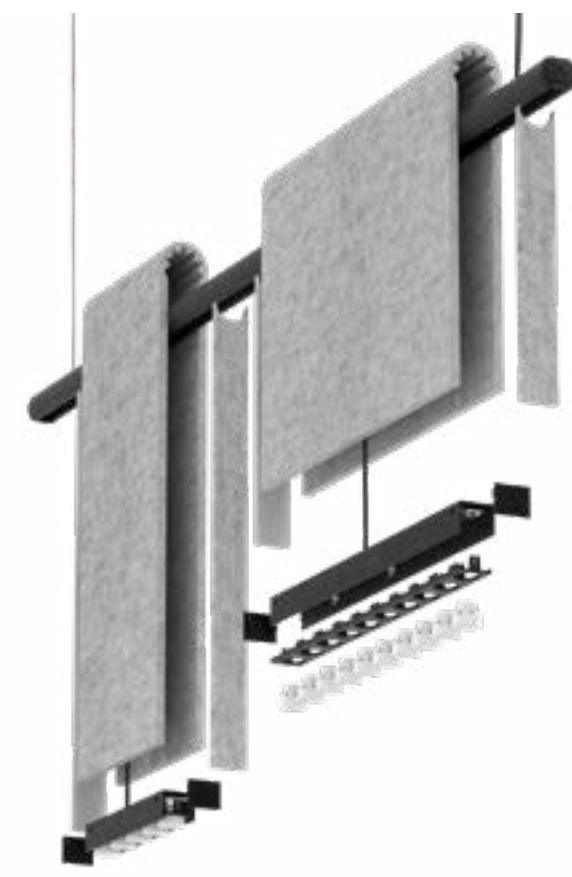

- ALUMINIUM PC
- 0°
- 0°
- CRI ≥90
- IK05
- IP40
- LIFE 50000H
- DIM OPTIONAL
- 48V. REMOTE
- 220-240 V 50-60 Hz
- CE

ACOUSTIC OKKO

REF 230003.PN

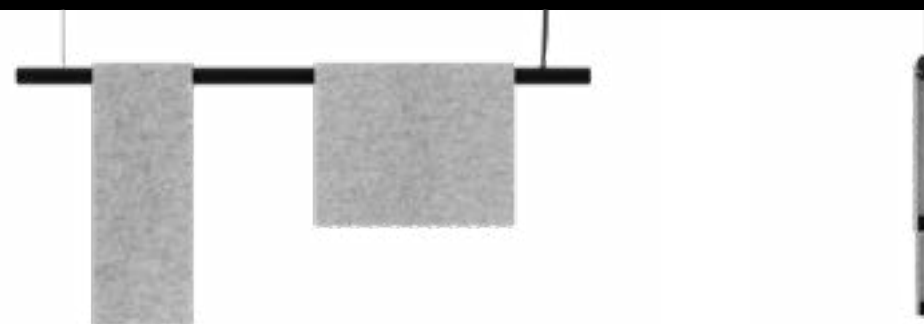

52

.PN
PENDANT

REFERENCE ORDER EXAMPLE | EJEMPLO DE REFERENCIA

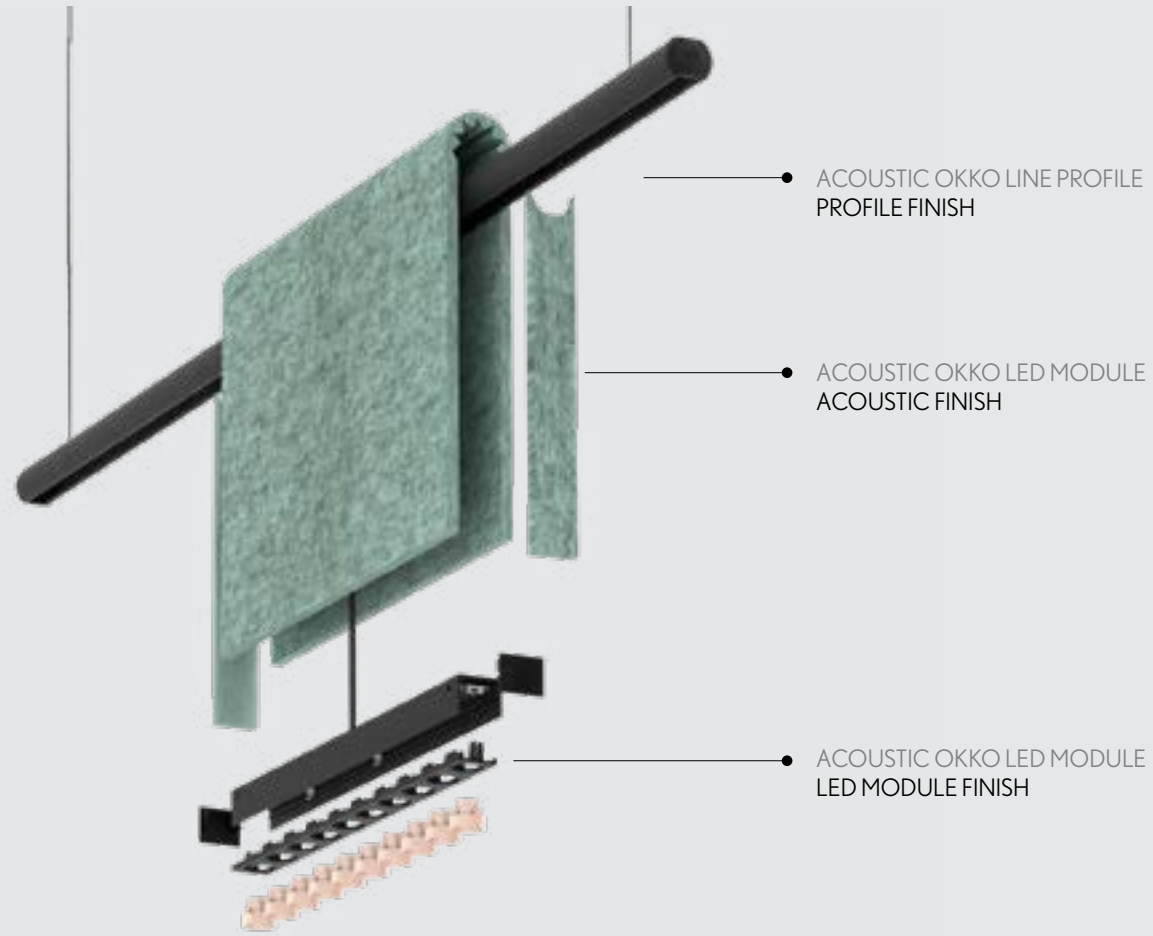

ACOUSTIC OKKO LINE PROFILE
PROFILE FINISH

ACOUSTIC OKKO LED MODULE
ACOUSTIC FINISH

ACOUSTIC OKKO LED MODULE
LED MODULE FINISH

ACOUSTIC OKKO LINE PROFILE

Reference order | 230003.01.PN.BK-BK

ACOUSTIC OKKO LED MODULES

Reference order | 140002.01.55-BK-CR.XX.ST9.XX.XX

ACOUSTIC OKKO LINE	REF.	DIM	FINISH	48V TRANSF	DIMENSION	WATT	LINEAR JOINT	POWER FEEDER UNIT	FINISH
	230003	.01 1000mm	.WH-WH .BK-BK	DR48	.01 .02 .03	75 120 200			.BK-BK .WH-WH

Reference order | 230003.01.PN.XX

Ref. order | DR48.XX

Ref. order | UR20

ACC230003.CA.XX

ACOUSTIC OKKO LED MODULES	REF.	DIMENSION	FINISH	OPTIC OPTIONS	POWER	CRI	LUMEN	WATT	mA	DIMM	SKETCH
	140001	.01	.50 .51 .55	.20 .40 .60	.ST	.9	552 623 660	6	500	.DA .D1	

Reference order | 140001.XX.XX.XX.XX.ST9.XX.XX

ACOUSTIC OKKO LED MODULES	REF.	DIMENSION	FINISH	OPTIC OPTIONS	POWER	CRI	LUMEN	WATT	mA	DIMM	SKETCH
	140002	.01	.50 .51 .55	.20 .40 .60	.ST	.9	114 1245 1320	12	500	.DA .D1	

Reference order | 140002.XX.XX.XX.XX.ST9.XX.XX

Select acoustic finishes

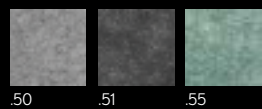

Select LED modules finishes

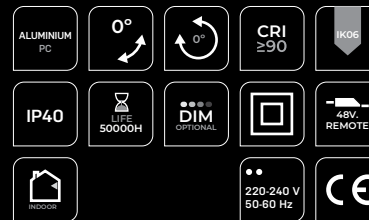
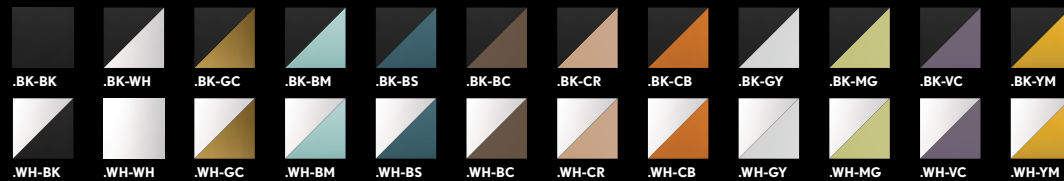

ACOUSTIC
OKKO

REF 230003.PN

ACOUSTIC PROPERTIES

- ENVIRONMENTAL: Comply with the requirements detailed in the BREEAM International, BREEAM-NOR v6.0 and LEED v4.1. Standards
- FIRE TEST: Classification B-s1, d0 and CTEDB-SI Compliant
- BAFFLE THICKNESS: 9 mm
- BABBLE DENSITY: 155Kg/m³
- SOUND ABSORPTION COEFFICIENT: 0,77 αw

Comply with the requirements detailed in the BREEAM International, BREEAM-NOR v6.0 and LEED v4.1. Standards
Classification B-s1, d0 and CTEDB-SI Compliant
9 mm
155Kg/m³
0,77 αw

PHOTOMETRY

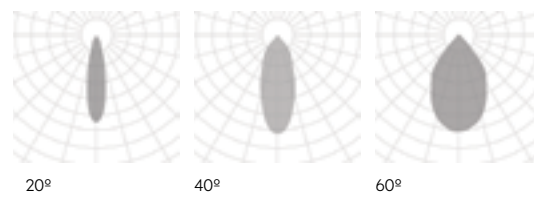

INCLUDED

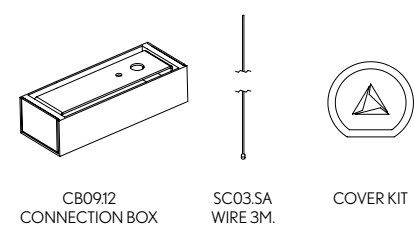

PROFILE

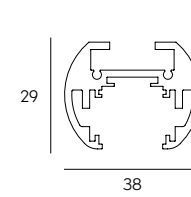

PENDANT

.PN

new



FINISHES

● ACOUSTIC COLORS



● PROFILE COLORS



DIMENSIONS

● DIAMETERS mm. | HEIGHT 50mm.

350 | 450 | 650 | 950 | 1250

LIGHTING OPTIONS

■ DIFFUSERS

SILICONE

POWER

STANDARD

CRI

90

COLOR TEMPERATURE

2700K | 3000K | 4000K

▼ DIMMABLE OPTIONS

DALI | 1.10 | PUSH

▲ LIGHT DISTRIBUTION

DOWN

LUMINAIRE INCLUDES

- 3 x Suspension cables 3m
- 1 x Feed Hose 3 x 0,75mm² (125 1 Feed Hose 5 x 0,75mm²)
- Electric system
- Connection Box CB03 + Driver Box CB04.OP
- Cover Kit

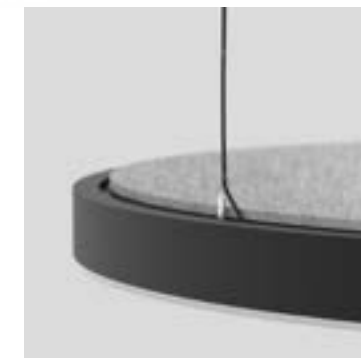
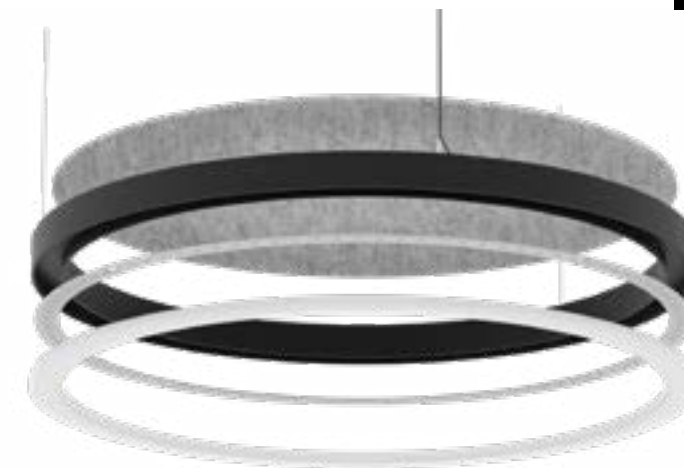

ON DEMAND

- Special RAL Color
- Number of switches
- Emergency Lighting*
- Motion Detection
- Tunable White
- RGB
- Wireless Control Options (Casambi)



* Delivered separately (not installed in luminaire).

- ALUMINUM SILICONE
- 0°
- 0°
- CRI ≥90
- IK08
- IP40
- LIFE 50000H
- DIM OPTIONAL
- REMOTE
- ROOM
- 220-240 V 50-60 Hz
- CE

ACOUSTIC ALBERTA SOFT

REF 230010.PN

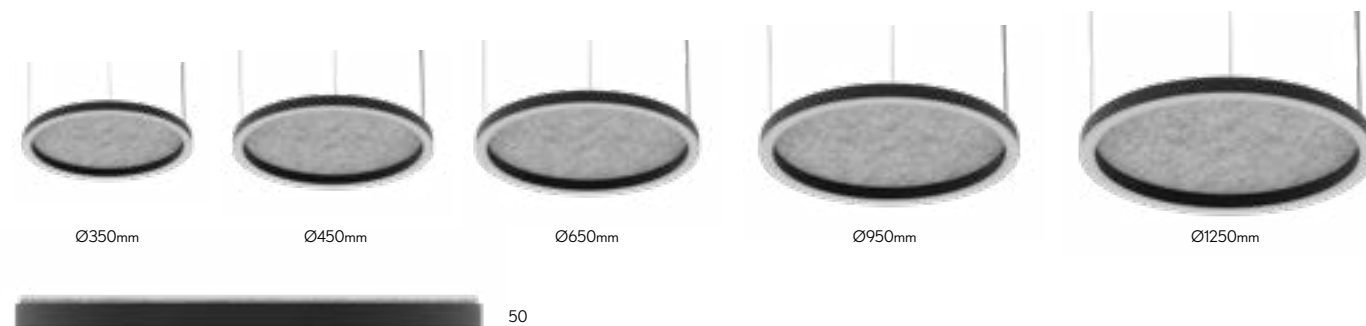

PENDANT .PN



ALBERTA SOFT	REF.	DIMENSION	FINISH	DIFFUSER	POWER	CRI	LUMEN			WATT	mA	DIMM	SKETCH	
							.27	.30	.40					
	230010	.35	.50 .51	WH BK	.SI	.HI	.9	5280	5316	5844	56	700	.DA .PU .D1	 Int. Ø 286 Ext. Ø 350
	230010	.45	.50 .51	WH BK	.SI	.HI	.9	7086	7121	7747	70	700	.DA .PU .D1	 Int. Ø 386 Ext. Ø 450
	230010	.65	.50 .51	WH BK	.SI	.HI	.9	8785	9040	9687	86	700	.DA .PU .D1	 Int. Ø 586 Ext. Ø 650
	230010	.95	.50 .51	WH BK	.SI	.HI	.9	13298	13519	14703	129	700	.DA .PU .D1	 Ø INT. 886 Ø EXT. 950
	230010	.125	.50 .51	WH BK	.SI	.HI	.9	17816	18135	18118	172	700	.DA .PU .D1	 Ø INT. 1186 Ø EXT. 1250

Reference order 230010.XX.PN.XX-XX.XX.HI9.XX.XX

DRIVER BOX NON-DIMM		DRIVER BOX DIMMABLE		FINISH
CB09.32	CB08.30	CB09.40	CB08.38	

Reference order CB09.XX.XX

Select Acoustic finishes

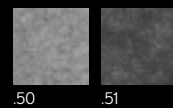

Select Profile finishes

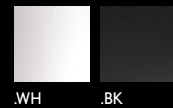

- ALUMINIUM SILICONE
- 0°
- 0°
- CRI ≥90
- IK05
- IP40
- LIFE 50000H
- DIM OPTIONAL
- REMOTE
- 220-240 V 50-60 Hz
- CE

ACOUSTIC ALBERTA SOFT

REF 230010.PN

ACOUSTIC PROPERTIES

- ENVIRONMENTAL:**
- FIRE TEST:**
- BAFFLE THICKNESS:**
- BABBLE DENSITY:**
- SOUND ABSORPTION COEFFICIENT:**

Comply with the requirements detailed in the BREEAM International, BREEAM-NOR v6.0 and LEED v4.1 Standards
 Classification B-s1, d0 and CTEDB-SI Compliant
 12 mm
 190Kg/m³
 0,92 αw

PHOTOMETRY



SILICONE

INCLUDED

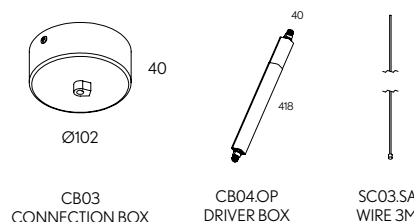

PROFILE

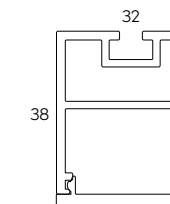

PENDANT

.PN

FINISHES

● ACOUSTIC COLORS



● PROFILE COLORS



DIMENSIONS

● mm.

800 | 1000 | 1200

LIGHTING OPTIONS

■ DIFFUSERS

OPAL

POWER

STANDARD

CRI

90

COLOR TEMPERATURE

2700K | 3000K | 4000K

▼ DIMMABLE OPTIONS

DALI | 1.10 | PUSH

▲ LIGHT DISTRIBUTION

DOWN

LUMINAIRE INCLUDES

3 x Suspension cables 3m
NON-DIM DOWN: 1 x Feed Hose 3 x 0,75mm²
DIM DOWN: 1 x Feed Hose 5 x 0,75mm²
Connection box CB03 with luminaire's finish



ON DEMAND

- Special RAL Color
- Special Color Temperature
- Emergency Lighting*
- Motion Detection
- RGB
- CRI 80
- Wireless Control Options (Casambi)

* Delivered separately (not installed in luminaire).

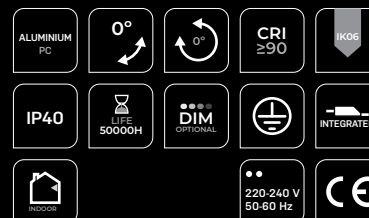



ACOUSTIC RD | SQ ALABAMA

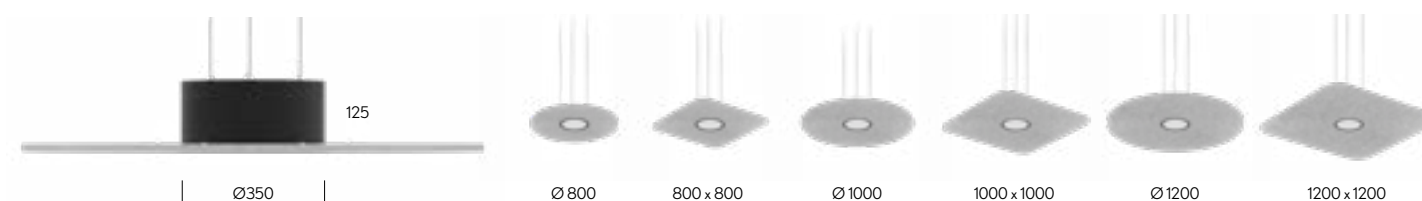

REF 460001.PN | 460003.PN

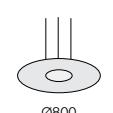

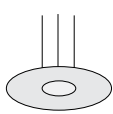
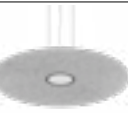
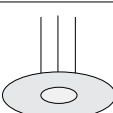
PENDANT .PN

ALABAMA RD	REF.	DIMENSION	FINISH		DIFFUSER	POWER	CRI	LUMEN			WATT	mA	DIMM	SKETCH
			WH	BK				.27	.30	.40				
	460001	.01	●	WH BK	.OP	.ST	.9	-	2385	2475	18	500	.DA .PU .D1	
		.02												
		.03												

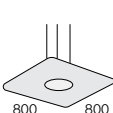
Reference order  460001.XX.PN.XX-XX.XX.XX.X.XX.XX

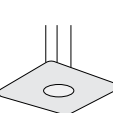
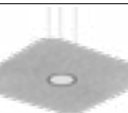
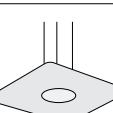
ALABAMA SQ	REF.	DIMENSION	FINISH		DIFFUSER	POWER	CRI	LUMEN			WATT	mA	DIMM	SKETCH
			WH	BK				.27	.30	.40				
	460003	.01	●	WH BK	.OP	.ST	.9	-	2385	2475	18	500	.DA .PU .D1	
		.02												
		.03												

Reference order  460003.XX.PN.XX-XX.XX.XX.X.XX.XX

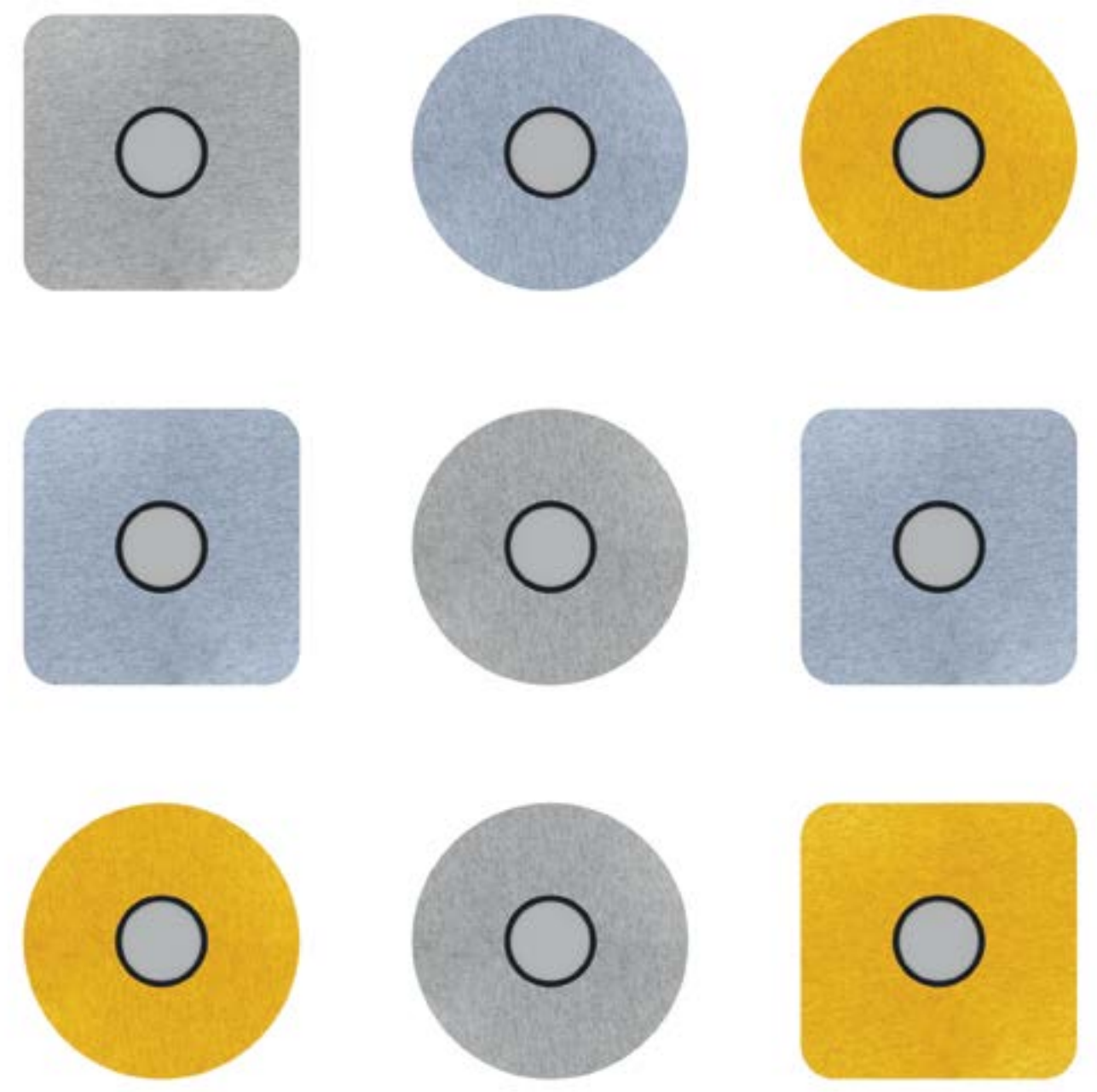

• Select Acoustic finishes



• Select Profile finishes

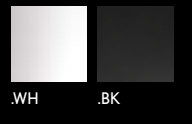

- ALUMINUM PC
- 0°
- 0°
- CRI ≥90
- IK05
- IP40
- LIFE 50000H
- DIM OPTIONAL
- INTEGRATED
- ROOM
- 220-240 V 50-60 Hz
- CE

ACOUSTIC RD | SQ ALABAMA

REF 460001.PN | 460003.PN

ACOUSTIC PROPERTIES

ENVIRONMENTAL:	Comply with the requirements detailed in the BREEAM International, BREEAM-NOR v6.0 and LEED v4.1. Standards
FIRE TEST:	Classification B-s1, d0 and CTEDB-SI Compliant
BAFFLE THICKNESS:	12 mm
BABBLE DENSITY:	190 Kg/m ³
SOUND ABSORPTION COEFFICIENT:	0,92 α _w

PHOTOMETRY

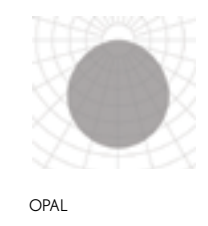

INCLUDED

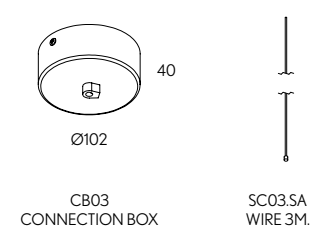

PROFILE

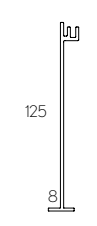



FINISHES

ACOUSTIC COLORS



SPOTLIGHT COLORS



DIMENSIONS

DIAMETERS mm

800 | 1000 | 1200

LIGHTING OPTIONS

BEAM ANGLE

15° 25° 38° 60°

POWER

STANDARD

CRI

90

COLOR TEMPERATURE

2700K | 3000K | 4000K

DIMMABLE OPTIONS

DALI | 1.10 | PUSH

LIGHT DISTRIBUTION

DOWN

LUMINAIRE INCLUDES

3 x Suspension cables 3m
1 x Feed Hose 3 x 0,75mm²
Connection box CB03 BK or WH finish

new

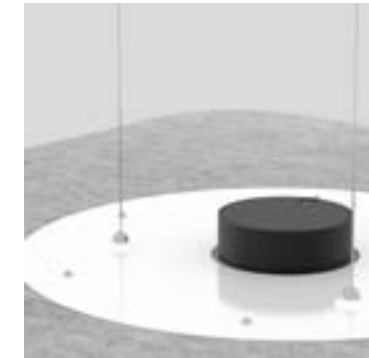

ON DEMAND

Dim to Warm
Tunable White
Wireless Control Options (Casambi)

* Accessories are delivered separately
(not installed in luminaire).

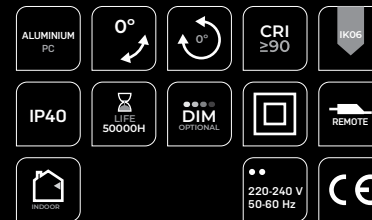

ACOUSTIC RD | SQ KLIMT FIX

REF 460002.PN | 460004.PN

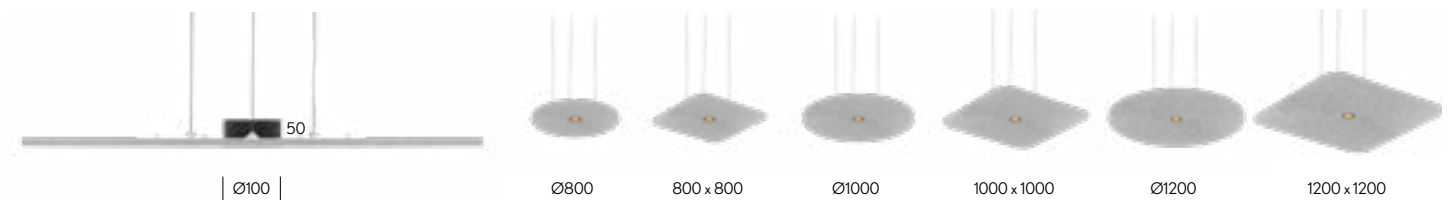

PENDANT

.PN



ROUND



SQUARE

KIMT FIX RD	REF.	DIMENSION	FINISH	OPTIC OPTIONS	POWER	CRI	LUMEN			WATT	mA	DIMM	SKETCH
							.27	.30	.40				
	460002	.01	● WH-WH BK-BK BK-GD WH-GD	■ .15 .25 .38 .60	.ST	.9	803	983	991	11	500	.DA .PU .D1	
		.02											
		.03											

Reference order | 460002.XX.PN.XX-XX.XX.XX.XX.XX.XX

KLIMT FIX SQ	REF.	DIMENSION	FINISH	OPTIC OPTIONS	POWER	CRI	LUMEN			WATT	mA	DIMM	SKETCH
							.27	.30	.40				
	460004	.01	● WH-WH BK-BK BK-GD WH-GD	■ .15 .25 .38 .60	.ST	.9	803	983	991	11	500	.DA .PU .D1	
		.02											
		.03											

Reference order | 460004.XX.PN.XX-XX.XX.XX.XX.XX.XX

● Select Acoustic finishes



● Select Spotlight finishes



- ALUMINUM PC
- 0°
- 0°
- CRI ≥90
- IK05
- IP40
- LIFE 50000H
- DIM OPTIONAL
- REMOTE
- 220-240 V 50-60 Hz
- CE

ACOUSTIC RD | SQ KLIMT FIX

REF 460002.PN | 460004.PN

ACOUSTIC PROPERTIES

- ENVIRONMENTAL:**
- FIRE TEST:**
- BAFFLE THICKNESS:**
- BABBLE DENSITY:**
- SOUND ABSORPTION COEFFICIENT:**

Comply with the requirements detailed in the BREEAM International, BREEAM-NOR v6.0 and LEED v4.1 Standards
 Classification B-s1, d0 and CTEDB-SI Compliant
 12 mm
 190 Kg/m³
 0,92 α_w

PHOTOMETRY

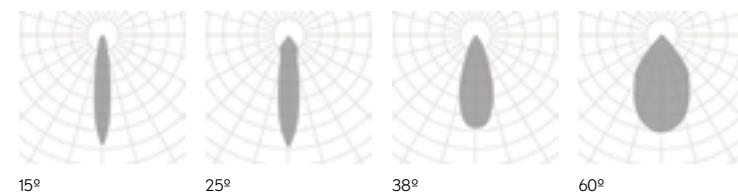

INCLUDED

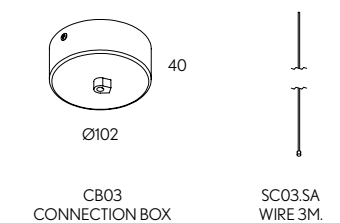

PENDANT .PN



FINISHES

ACOUSTIC COLORS

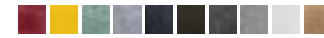

DIMENSIONS

SIZES mm.

Ø800	Ø1000	Ø1200
800x800	1000x1000	1200x1200

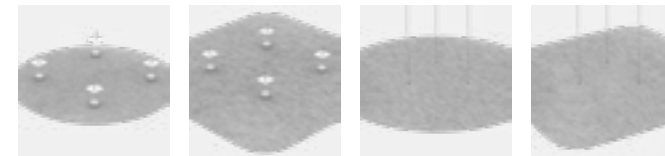
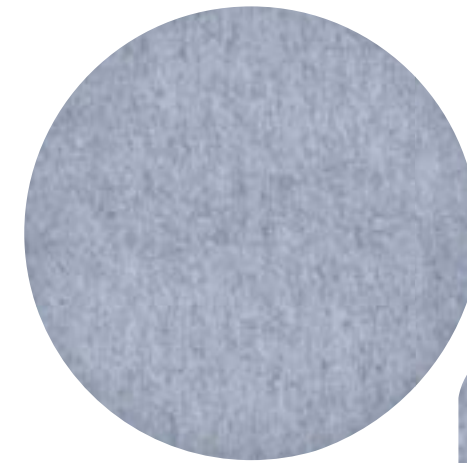

.SR .SR .PN .PN

RD PANEL	REF.	DIMENSION	FINISH	SKETCH
	AC.RD	.01	●	 Ø800
		.02		 Ø1000
		.03		 Ø1200

Reference order | AC.RD.XX | .SR | .PN | .XX

SQ PANEL	REF.	DIMENSION	FINISH	SKETCH
	AC.SQ	.01	●	 800x800
		.02		 1000x1000
		.03		 1200x1200

Reference order | AC.SQ.XX | .SR | .PN | .XX

ACOUSTIC ACCESORIES RD | SQ PANEL

REF AC.RD | AC.SQ

ACOUSTIC PROPERTIES

ENVIRONMENTAL:	Comply with the requirements detailed in the BREEAM International, BREEAM-NOR v6.0 and LEED v4.1. Standards
FIRE TEST:	Classification B-s1, d0 and CTEDB-SI Compliant
BAFFLE THICKNESS:	12 mm
BABBLE DENSITY:	190 Kg/m ³
SOUND ABSORPTION COEFFICIENT:	0,92 αw

Select Acoustic finishes

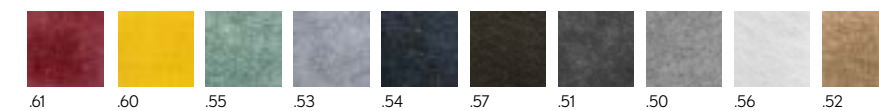

PENDANT | SURFACE
SR
PN

FINISHES

ACOUSTIC COLORS



DIMENSIONS

SIZES mm

2400x300 | 2400x600



.PN

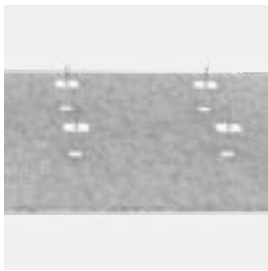

.SR

RD PANEL	REF.	DIMENSION	FINISH	SKETCH
	AC.FL	.01	●	
		.02		

Reference order | AC.FL.XX | .SR | .PN | .XX

ACOUSTIC ACCESORIES FL PANEL

REF AC.FL

FINISHES

ACOUSTIC COLORS



DIMENSIONS

SIZES mm

2400x300 | 2400x600



.PN

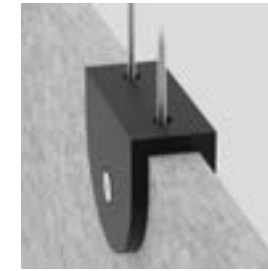

.SR

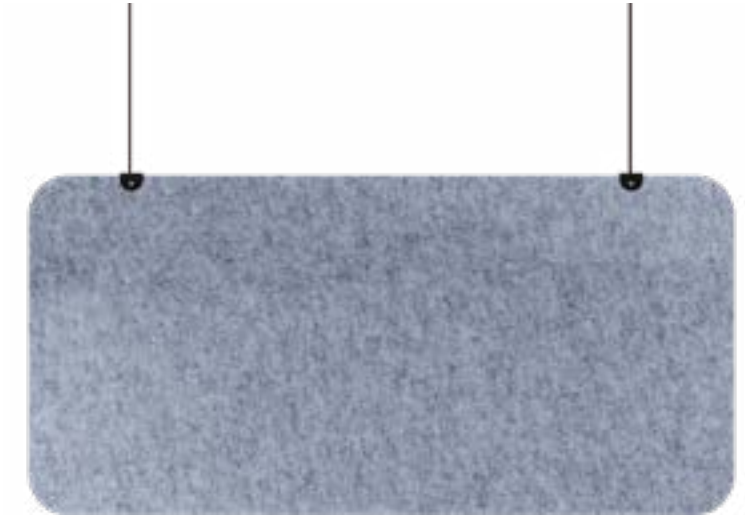

RD PANEL	REF.	DIMENSION	FINISH	SKETCH
	AC.VT	.01	●	
		.02		

Reference order | AC.VT.XX | .SR | .PN | .XX

ACOUSTIC ACCESORIES VT PANEL

REF AC.VT

ACOUSTIC PROPERTIES

ENVIRONMENTAL:

Comply with the requirements detailed in the BREEAM International, BREEAM-NOR v6.0 and LEED v4.1 Standards

FIRE TEST:

Classification B-s1, d0 and CTEDB-SI Compliant

BAFFLE THICKNESS:

12 mm

BABBLE DENSITY:

190 Kg/m³

SOUND ABSORPTION COEFFICIENT:

0,92 α_w

Select Acoustic finishes

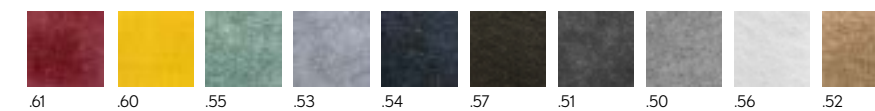

SR
PN
PENDANT | SURFACE



new

FINISHES

● COLORS



DIMENSIONS

◆ SIZES mm.

600x600 | 1200x600



RD PANEL	REF.	DIMENSION	FINISH	SKETCH
	AC.MD	.01	●	
		.02		

Reference order AC.MD.XX.RF.XX

ACOUSTIC ACCESORIES MD PANEL

REF AC.MD.RF

RECESSED FRAME .RF

ACOUSTIC PROPERTIES

- ENVIRONMENTAL:** Comply with the requirements detailed in the BREEAM International, BREEAM-NOR v6.0 and LEED v4.1 Standards
- FIRE TEST:** Classification B-s1, d0 and CTEDB-SI Compliant
- BAFFLE THICKNESS:** 12 mm
- BABBLE DENSITY:** 190 Kg/m³
- SOUND ABSORPTION COEFFICIENT:** 0,92 αw

Select Acoustic finishes

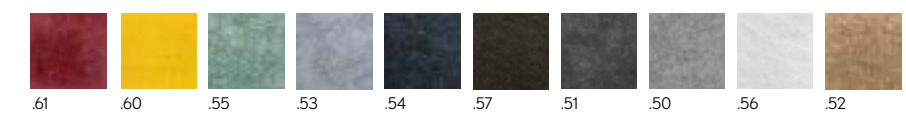

Avant-garde design

With flair and imagination, some products offer boundless possibilities. Our Tech lights bring you to a journey of simple designs that enhance every project and adapt to every need: Klimt, Martorell, Cube, among others...

Estética vanguardista

Con estilo e imaginación, algunos productos ofrecen grandes posibilidades. Esta colección te invita a un viaje de diseños sencillos que realzan cada proyecto y se adaptan a cada necesidad: Klimt, Martorell, Cube entre otros...



TECH

PENDANT | SURFACE

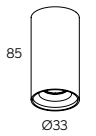
MARTORELL	REF.	DIMENSIONS	FINISHES	LAMP	OPTIC OPTIONS	POWER	CRI	K	LUMEN	WATT	mA	DIMM *1	SKETCH
	20115	.01 *2	●	LED	.24 .32	.ST	.9	.27 .30 .40	175 188 199	3	700	.DA .PU .D1	

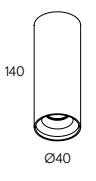
	20115	.02	●	LED	.15 .24 .32	.ST	.9	.27 .30 .40	470 498 515	8	700	.DA .PU .D1	
---	-------	-----	---	-----	-------------------	-----	----	-------------------	-------------------	---	-----	-------------------	---

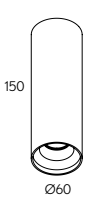
	20115	.03	●	LED	.15 .24 .32 .60	.ST	.9	.27 .30 .40	1071 1156 1198	12	350	.DA .PU .D1	
---	-------	-----	---	-----	--------------------------	-----	----	-------------------	----------------------	----	-----	-------------------	---

Reference order | 20115.XX | SR | PN | .XX.XX.ST9.XX.XX

Select finishes

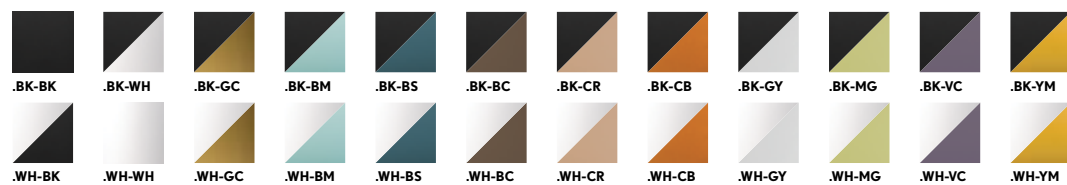

*1 Remote driver when dimmable. *Driver remoto cuando es dimable.*

*2 Dimming options require the combination of a minimum of 2 luminaires. *Las opciones de regulación necesitan la combinación de un mínimo de 2 luminarias.*

FINISHES

EXTERNAL COLOR



INTERNAL COLOR



DIMENSIONS

View in family specifications

.01 | .02 | .03

LIGHTING OPTIONS

BEAM ANGLE

15° | 24° | 32° | 60°

POWER

STANDARD

CRI

90

COLOR TEMPERATURE

2700K | 3000K | 4000K

DIMMABLE OPTIONS

DALI | 1.10 | PUSH

LIGHT DISTRIBUTION

DOWN

ON DEMAND

Dim to Warm (.02, .03)
Tunable White (.02, .03)
Honey Comb (.03)
Wireless Control Options
Special RAL Color



.SR

.PN

PENDANT | SURFACE

INSTALLATIONS

.PN
PENDANT

·20115 MARTORELL | PN
Pag. 322

.TK
TRACKLIGHT

·20115 MARTORELL | TK
Pag. 744

.SR
SURFACE

·20115 MARTORELL | SR
Pag. 322

.RF
RECESSED FRAME

·20115 MARTORELL | RF
Pag. 494

.TR
TRIMLESS

·20115 MARTORELL | TR
Pag. 676





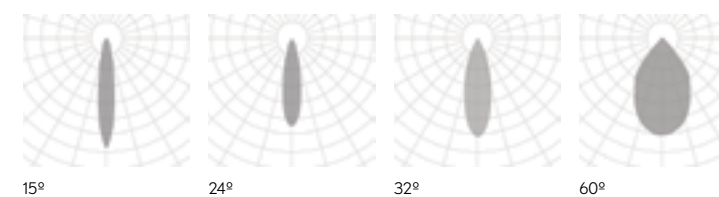

PHOTOMETRY

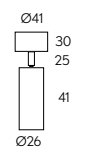

MARTORELL

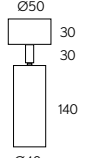
REF 20115.PN | 20115.SR

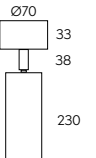
MARTORELL MOVE	REF.	DIMENSIONS	FINISHES	LAMP	OPTIC OPTIONS	POWER	CRI	K	LUMEN	WATT	mA	DIMM ^{*1}	SKETCH
	20110	.01	●	LED	.20 .40 .60	.ST	.9	.27 .30 .40	167 184 206	3	700	.DA .PU .D1	
	20110	.02	●	LED	.18 .25 .35	.ST	.9	.27 .30 .40	465 507 548	9	700	.DA .PU .D1	
	20110	.03	●	LED	.18 .25 .35	.ST	.9	.27 .30 .40	1058 1096 1231	15	350	.DA .PU .D1	

Reference order |  20110.XX.SR.XX.XX.ST9.XX.XX

● Select finishes

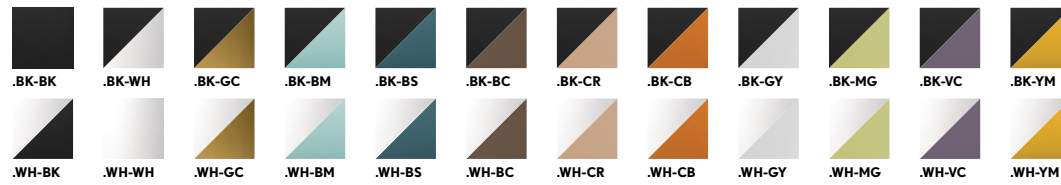

*1 Remote driver when dimmable. *Driver remoto cuando es dimable.*

*2 Dimming options require the combination of a minimum of 2 luminaires. *Las opciones de regulación necesitan la combinación de un mínimo de 2 luminarias.*

● FINISHES

EXTERNAL COLOR



INTERNAL COLOR



DIMENSIONS

● View in family specifications

.01 | .02 | .03

LIGHTING OPTIONS

■ BEAM ANGLE

18° | 20° | 25° | 35° | 40° | 60°

POWER

STANDARD

CRI

90

COLOR TEMPERATURE

2700K | 3000K | 4000K

▼ DIMMABLE OPTIONS

DALI | 1.10 | PUSH

▲ LIGHT DISTRIBUTION

DOWN

ON DEMAND

Dim to Warm (.02, .03)
Tunable White (.02, .03)
Honey Comb (.03)
Wireless Control Options



INSTALLATIONS



.SR
SURFACE

·20110 MARTORELL MOVE | SR
Pag. 324



.RF
RECESSED FRAME

·20110 MARTORELL MOVE | RF
Pag. 496

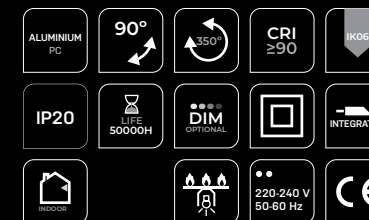

PHOTOMETRY

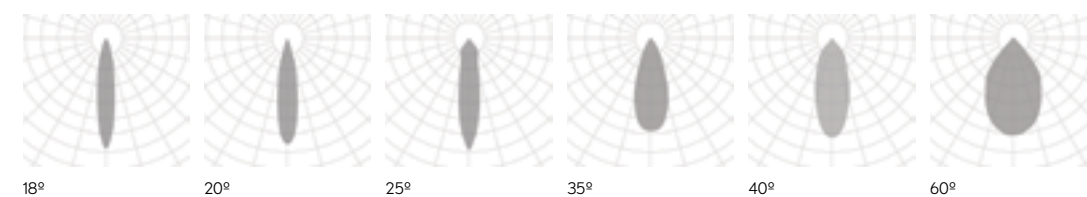

MARTORELL
MOVE

REF 20110.SR

SURFACE

.SR

MARTORELL TUBE MOVE	REF.	DIMENSIONS	FINISHES	LAMP	OPTIC OPTIONS	POWER	CRI	K	LUMEN	WATT	mA	DIMM *1	SKETCH
	20138	.03	●	LED	.19 .24 .36	.ST	.9	.27 .30 .40	796 841 929	10	500	.DA .PU .D1	

Reference order 20138.03.SR.XX.XX.ST9.XX.XX

FINISHES

EXTERNAL COLOR



INTERNAL COLOR



DIMENSIONS

View in family specifications

.01

LIGHTING OPTIONS

BEAM ANGLE

19° | 24° | 36°

POWER

STANDARD

CRI

90

COLOR TEMPERATURE

2700K | 3000K | 4000K

DIMMABLE OPTIONS

DALI | 1.10 | PUSH

LIGHT DISTRIBUTION

DOWN

ON DEMAND

Dim to Warm
Tunable White
Wireless Control Options



Select finishes

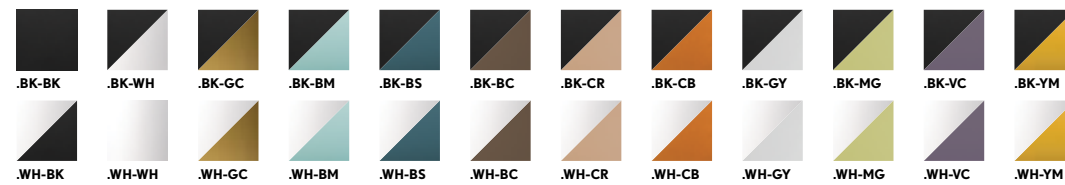

*1 Remote driver when dimmable. Driver remoto cuando es dimable.

INSTALLATIONS



.SR
SURFACE

·20138 MARTORELL TUBE MOVE | SR
Pag. 326



.TK
TRACKLIGHT

·20138 MARTORELL TUBE MOVE | TK
Pag. 746



PHOTOMETRY

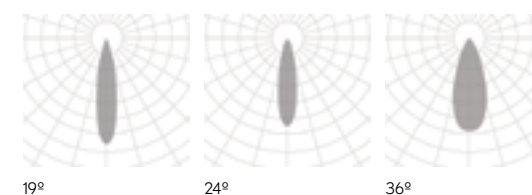





MARTORELL TUBE MOVE

REF 20138.SR

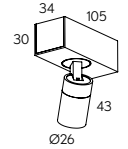

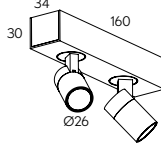
SURFACE

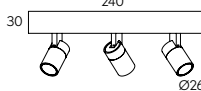
MARTORELL MINI CRATE	REF.	DIMENSIONS	FINISHES	LAMP	OPTIC OPTIONS	POWER	CRI	K	LUMEN	WATT	mA	DIMM *1	SKETCH
	20175	.01 *2	●	LED	.9 .16 .30	.ST	.9	.27	175	3	700	.DA .PU .D1	
								.30	188				
								.40	199				
	20175	.02	●	LED	.20 .40 .60	.ST	.9	.27	350	6	700	.DA .PU .D1	
								.30	276				
								.40	398				
	20175	.03	●	LED	.20 .40 .60	.ST	.9	.27	525	9	700	.DA .PU .D1	
								.30	564				
								.40	597				

Reference order  20175.XX.SR.XX.XX.ST.9.XX.XX

● Select external-internal finishes

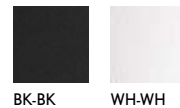

*1 Remote driver when dimmable. Driver remoto cuando es dimmable.

FINISHES

COLOR



DIMENSIONS

View in family specifications

.01 | .02 | .03

LIGHTING OPTIONS

BEAM ANGLE

9° | 16° | 20° | 30° | 40° | 60°

POWER

STANDARD

CRI

90

COLOR TEMPERATURE

2700K | 3000K | 4000K

DIMMABLE OPTIONS

DALI | 1.10 | PUSH

LIGHT DISTRIBUTION

DOWN

ON DEMAND

Wireless Control Options



.SR

SURFACE

INSTALLATIONS



.SR
SURFACE

·20175 MARTORELL MINI CRATE | SR
Pag. 328



.RF
RECESSED FRAME

·20175 MARTORELL MINI CRATE | RF
Pag. 502



MARTORELL MINI CRATE

REF 20175.SR

PHOTOMETRY

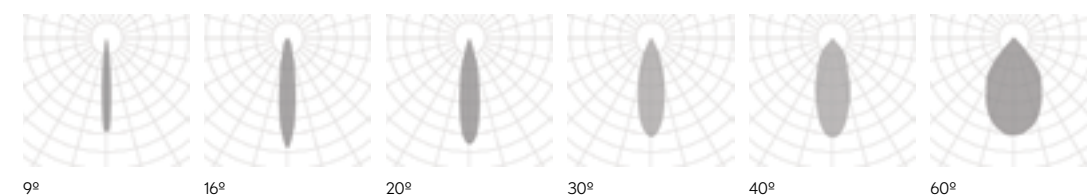

MARTORELL CRATE	REF.	DIMENSIONS	FINISHES	LAMP	OPTIC OPTIONS	POWER	CRI	K	LUMEN	WATT	mA	DIMM *1	SKETCH
	20176	.01	●	LED	.15 .24 .32	.ST	.9	.27 .30 .40	470 498 515	8	700	.DA .PU .D1	
	20176	.02	●	LED	.15 .24 .32	.ST	.9	.27 .30 .40	940 996 1030	16	700	.DA .PU .D1	
	20176	.03	●	LED	.15 .24 .32	.ST	.9	.27 .30 .40	1410 1494 1545	24	700	.DA .PU .D1	

Reference order | 20176.XX.SR.XX.XX.ST.9.XX.XX

● Select finishes

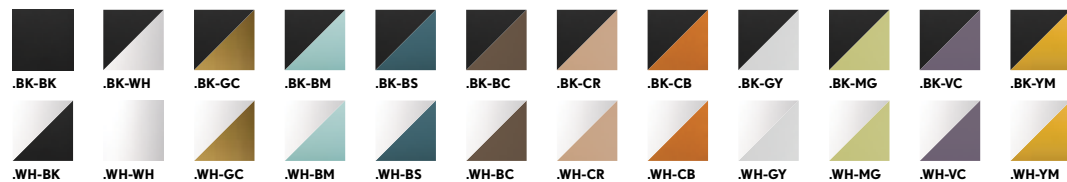

*1 Remote driver when dimmable. *Driver remoto cuando es dimable.*

FINISHES

EXTERNAL COLOR



INTERNAL COLOR



DIMENSIONS

● View in family specifications

.01 | .02 | .03

LIGHTING OPTIONS

■ BEAM ANGLE

15° | 24° | 32°

POWER

STANDARD

CRI

90

COLOR TEMPERATURE

2700K | 3000K | 4000K

▼ DIMMABLE OPTIONS

DALI | 1.10 | PUSH

▲ LIGHT DISTRIBUTION

DOWN

ON DEMAND

Dim to Warm
Tunable White
Wireless Control Options



INSTALLATIONS



.SR
SURFACE

·20176 MARTORELL CRATE | SR
Pag. 330



.RF
RECESSED FRAME

·20176 MARTORELL CRATE | RF
Pag. 504



PHOTOMETRY

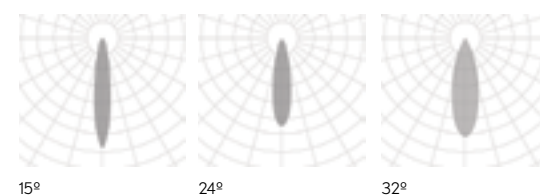

MARTORELL CRATE

REF 20176.SR



.SR

SURFACE

MARTORELL SQ	REF.	DIMEN-SIONS	FINISHES	LAMP	OPTIC OPTIONS	POWER	CRI	K	LUMEN	WATT	mA	DIMM *1	SKETCH
	20132	.01	●	LED	.15 .25 .38	.ST	.9	.27 .30 .40	720 759 908	10	500	.DA .PU .D1	

Reference order 20132.01.SR.XX.XX.ST9.XX.XX

MARTORELL SQ2	REF.	DIMEN-SIONS	FINISHES	LAMP	OPTIC OPTIONS	POWER	CRI	K	LUMEN	WATT	mA	DIMM	SKETCH
	20133	.01	●	LED	.15 .25 .38	.ST	.9	.27 .30 .40	1440 1518 1816	20	500	.DA .PU .D1	

Reference order 20133.01.SR.XX.XX.ST9.XX.XX

● Select finishes

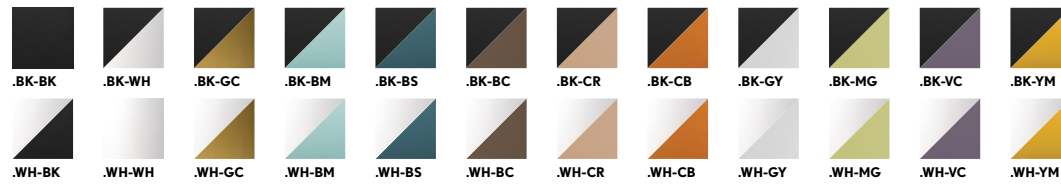

*1 Remote driver when dimmable. *Driver remoto cuando es dimable.*

FINISHES

EXTERNAL COLOR



INTERNAL COLOR



DIMENSIONS

● View in family specifications

.01

LIGHTING OPTIONS

■ BEAM ANGLE

15° | 25° | 38°

POWER

STANDARD

CRI

90

COLOR TEMPERATURE

2700K | 3000K | 4000K

▼ DIMMABLE OPTIONS

DALI | 1.10 | PUSH

▲ LIGHT DISTRIBUTION

DOWN

ON DEMAND

Dim to Warm
Tunable White
Wireless Control Options
Special RAL Color



INSTALLATIONS

.SR
SURFACE

·20132 MARTORELL SQ | SR ·20133 MARTORELL SQ2 | SR
Pag. 332



MARTORELL

SQ | SQ2

REF 20132.SR | REF 20133.SR

PHOTOMETRY

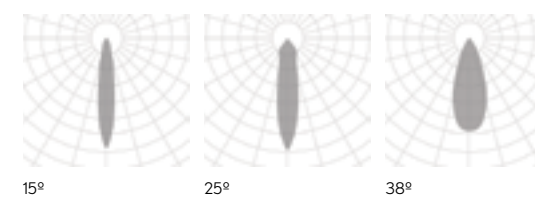

.SR

SURFACE

MARTORELL TUBULAR 20	REF.	DIMEN-SIONS	FINISHES	LAMP	OPTIC OPTIONS	POWER	CRI	K	LUMEN	WATT	mA	DIMM *1	SKETCH
	20125	.01	.BK-BK .WH-WH	LED	.20 .40	.ST	.9	.27	174	3	300	.DA .PU .D1	600
								.30	187				Ø22.5
								.40	212				
	20125	.02	.BK-BK .WH-WH	LED	.20 .40	.ST	.9	.27	174	3	300	.DA .PU .D1	1000
								.30	187				Ø22.5
								.40	212				

Reference order | 20125.XX.PN.XX.XX.ST9.XX.XX

MARTORELL TUBULAR 40	REF.	DIMEN-SIONS	FINISHES	LAMP	OPTIC OPTIONS	POWER	CRI	K	LUMEN	WATT	mA	DIMM *1	SKETCH
	20192	.01	●	LED	.20 .40	.ST	.9	.27	954	14	300	.DA .PU .D1	400
								.30	991				Ø40
								.40	1067				
	20192	.02	●	LED	.20 .40	.ST	.9	.27	954	14	300	.DA .PU .D1	600
								.30	991				Ø40
								.40	1067				

Reference order | 20192.XX.SR.PN.XX.XX.ST9.XX.XX

MARTORELL TUBULAR 60	REF.	DIMEN-SIONS	FINISHES	LAMP	OPTIC OPTIONS	POWER	CRI	K	LUMEN	WATT	mA	DIMM *1	SKETCH
	20196	.01	●	LED	.20 .40	.ST	.9	.27	1662	21	350	.DA .PU .D1	400
								.30	1716				Ø60
								.40	1729				
	20196	.02	●	LED	.20 .40	.ST	.9	.27	1662	21	350	.DA .PU .D1	600
								.30	1716				Ø60
								.40	1729				

Reference order | 20196.XX.SR.PN.XX.XX.ST9.XX.XX

*1 Remote driver when dimmable. Driver remoto cuando es dimmable.
*2 Remote driver when is .SR installation. Driver remoto cuando sea instalación .SR.

FINISHES

EXTERNAL COLOR



INTERNAL COLOR



DIMENSIONS

View in family specifications

.01 | .02

LIGHTING OPTIONS

BEAM ANGLE

20° | 40°

POWER

STANDARD

CRI

90

COLOR TEMPERATURE

2700K | 3000K | 4000K

DIMMABLE OPTIONS

DALI | 1.10 | PUSH

LIGHT DISTRIBUTION

DOWN

INCLUDED (.PN)

Suspension cable 1.5m
Connection box with luminaire's finish

ON DEMAND

Dim to Warm
Tunable White
Wireless Control Options
Special RAL Color

Select finishes

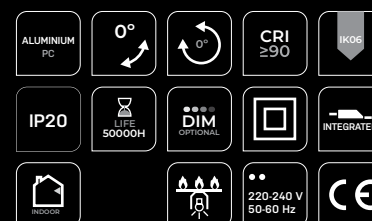
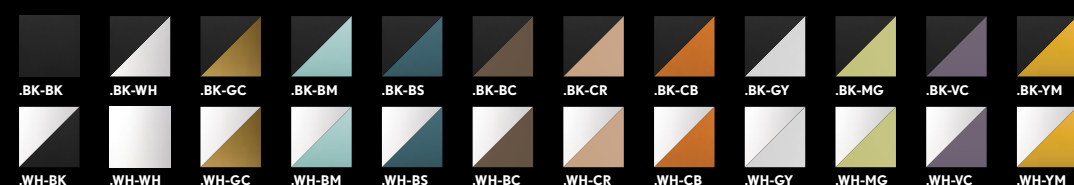

MARTORELL
TUBULAR 20 | 40 | 60
REF 20125.PN | 20192.PN | 20196.PN
20192.SR | 20196.SR

INSTALLATIONS

.PN
PENDANT

· 20125 TUBULAR 20 · 20192 TUBULAR 40 · 20196 TUBULAR 60
Pag. 334

.SR
SURFACE

20192 TUBULAR 40 · 20196 TUBULAR 60
Pag. 334

PHOTOMETRY

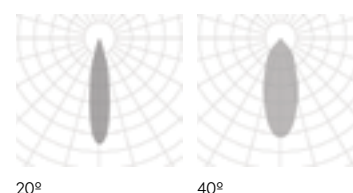



MARTORELL TILT	REF.	DIMENSIONS ▲	FINISHES ●	LAMP	OPTIC OPTIONS ■	POWER	CRI	K	LUMEN	WATT	mA	DIMM *1 ▼	SKETCH
	20195	.01	●	LED	.20 .40	.ST	.9	.27 .30 .40	164 155 188	3	700	.DA .PU .D1	

Reference order | 20195.01.SR.XX.XX.ST9.XX.XX

● Select internal - external finishes



.WH-WH .BK-BK

*1 Remote driver when dimmable. *Driver remoto cuando es dimable.*

FINISHES

COLOR



DIMENSIONS

● View in family specifications

.01

LIGHTING OPTIONS

■ BEAM ANGLE

20° | 40°

POWER

STANDARD

CRI

90

COLOR TEMPERATURE

2700K | 3000K | 4000K

▼ DIMMABLE OPTIONS

DALI | 1.10 | PUSH

▲ LIGHT DISTRIBUTION

DOWN

ON DEMAND

Dim to Warm
Tunable White
Wireless Control Options
Special RAL Color



SURFACE

INSTALLATIONS

.SR
SURFACE

·20195 MARTORELL TUBULAR TILT | SR
Pag. 336

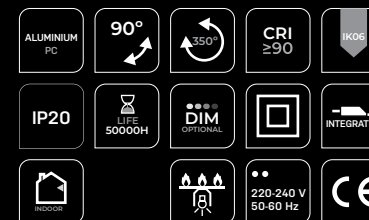

MARTORELL TUBULAR TILT



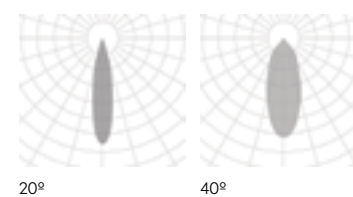

REF 20195.SR

PHOTOMETRY

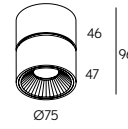

20°

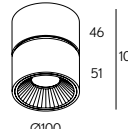
40°

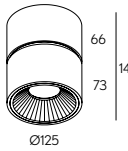
KLIMT	REF.	DIMEN- SIONS	FINISHES	LAMP	OPTIC OPTIONS	POWER	CRI	K	LUMEN	WATT	mA	DIMM *1	SKETCH
	20134	.01	●	LED	.15 .24 .38	.ST	.9	.27 .30 .40	395 497 550	8	700	.DA .PU .D1	
	20134	.02	●	LED	.15 .24 .38 .60	.ST	.9	.27 .30 .40	803 983 991	11	500	.DA .PU .D1	
	20134	.03	●	LED	.15 .24 .38 .60	.ST	.9	.27 .30 .40	1945 2073 2311	30	700	.DA .PU .D1	

Reference order | 20134.XX.SR.XX.XX.ST.9.XX.XX

● Select external - internal finishes



FINISHES

EXTERNAL COLOR



INTERNAL COLOR



DIMENSIONS

● View in family specifications

.01 | .02 | .03

LIGHTING OPTIONS

■ BEAM ANGLE

15° | 24° | 38° | 60°

POWER

STANDARD

CRI

90

COLOR TEMPERATURE

73

2700K | 3000K | 4000K

▼ DIMMABLE OPTIONS

DALI | 1.10 | PUSH

▲ LIGHT DISTRIBUTION

DOWN

ON DEMAND

Dim to Warm
Tunable White
Wireless Control Options
Special RAL Color



*1 Remote driver when dimmable (.01.02). Driver remoto cuando es dimable (.01.02).

INSTALLATIONS

.SR
SURFACE

·20134 KLIMT | SR
Pag. 338

.TK
TRACKLIGHT

·20134 KLIMT | TK
Pag. 748

.RF
RECESSED FRAME

·20134 KLIMT | RF
Pag. 508

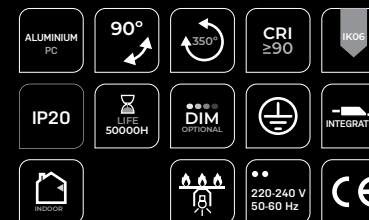

KLIMT

REF 20134.SR

PHOTOMETRY

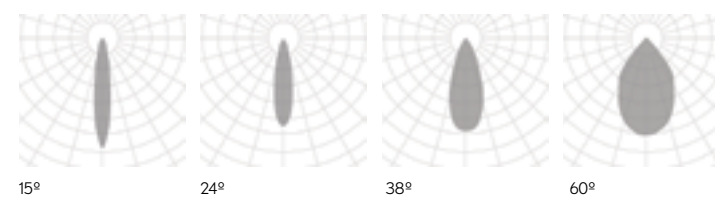

KLIMT FIX	REF.	DIMENSIONS	FINISHES	LAMP	OPTIC OPTIONS	POWER	CRI	K	LUMEN	WATT	mA	DIMM **	SKETCH
	20135	.01	●	LED	.15 .24 .38	.ST	.9	.27	395	8	700	.DA .PU .D1	
								.30	497				
								.40	550				
	20135	.02	●	LED	.15 .25 .38 .60	.ST	.9	.27	803	11	500	.DA .PU .D1	
								.30	983				
								.40	991				
	20135	.03	●	LED	.15 .28 .40 .60	.ST	.9	.27	1945	30	700	.DA .PU .D1	
								.30	2073				
								.40	2311				

Reference order | 20135.XX.SR.XX.XX.ST9.XX.XX

PHOTOMETRY

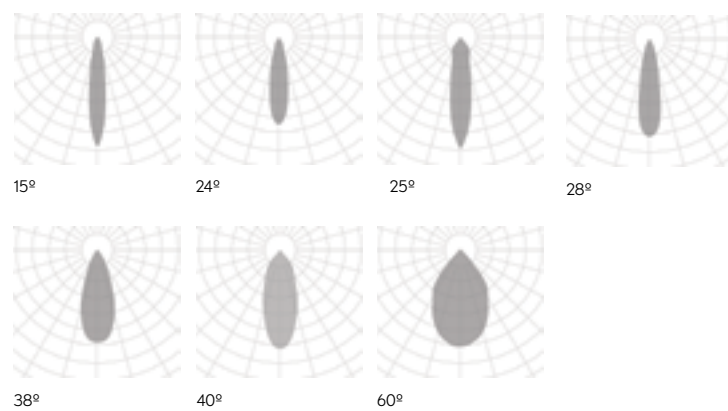

● Select external - internal finishes



FINISHES

EXTERNAL COLOR



INTERNAL COLOR



DIMENSIONS

● View in family specifications

.01 | .02 | .03

LIGHTING OPTIONS

■ BEAM ANGLE

15° | 24° | 25° | 28° | 38° | 40° | 60°

POWER

STANDARD

CRI

90

COLOR TEMPERATURE

2700K | 3000K | 4000K

▼ DIMMABLE OPTIONS

DALI | 1.10 | PUSH

▲ LIGHT DISTRIBUTION

DOWN

ON DEMAND

Dim to Warm
Tunable White
Wireless Control Options
Special RAL Color



INSTALLATIONS

.SR
SURFACE

·20135 KLIMT FIX | SR
Pag. 340

.RF
RECESSED FRAME

·20135 KLIMT FIX | RF
Pag. 510



KLIMT FIX

REF 20135.SR



SURFACE

.SR

new

GEO	REF.	DIMENSIONS	FINISHES	LAMP	OPTIC OPTIONS	POWER	CRI	K	LUMEN	WATT	mA	DIMM *1	SKETCH
	30511	.01	●	LED	.15 .24 .38	.ST	.9	.27 .30 .40	498 513 622	8	700	.DA .PU .D1	 102 Ø82
	30511	.02	●	LED	.15 .25 .38 .60	.ST	.9	.27 .30 .40	1075 1114 1319	14	500	.DA .PU .D1	 115 Ø102
	30511	.03	●	LED	.15 .28 .40 .60	.ST	.9	.27 .30 .40	1856 2031 2529	30	700	.DA .PU .D1	 133 Ø125

Reference order | 30511.XX.SR.XX.XX.ST9.XX.XX

PHOTOMETRY

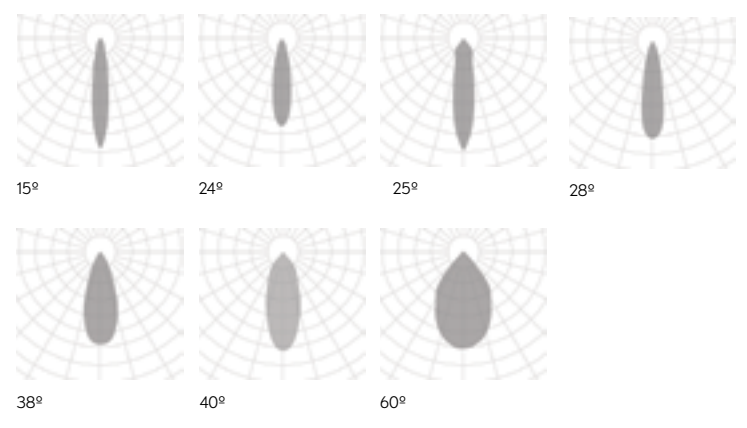

● Select external - internal finishes
BK-BK WH-WH

*1 Remote driver when dimmable. (01.02) Driver remoto cuando es dimable (01.02).

FINISHES

COLORS



DIMENSIONS

View in family specifications

.01 | .02 | .03

LIGHTING OPTIONS

BEAM ANGLE

15° | 24° | 25° | 28° | 38° | 40° | 60°

CRI

90

COLOR TEMPERATURE

2700K | 3000K | 4000K

DIMMABLE OPTIONS

DALI | 1.10 | PUSH

LIGHT DISTRIBUTION

DOWN

ON DEMAND

Dim to Warm
Tunable White
Wireless Control Options
Special RAL Color



INSTALLATIONS

- .SR**
SURFACE
-30511GEO|SR
Pag. 342
- .TK**
TRACKLIGHT
-30511GEO|TK
Pag. 750
- .RF**
RECESSED FRAME
-30511GEO|RF
Pag. 512

- ALUMINIUM PC
- 90°
- 350°
- CRI ≥ 90
- IK05
- IP20
- LIFE 50000H
- DIM OPTIONAL
- INTEGRATED
- RECESSED
- 220-240 V 50-60 Hz
- CE

GEO

REF 30511.SR



SURFACE .SR

LUK FREIR	REF.	DIMENSIONS	FINISHES	LAMP	OPTIC OPTIONS	POWER	CRI	K	LUMEN	WATT	mA	DIMM*	SKETCH
	20018	.01	●	.LED	.40 .60	.ST	.9	.27	830	9	350	.DA .PU .D1	
								.30	845				
								.40	895				
	20018	.02	●	.LED	.40 .60	.ST	.9	.27	1271	16	500	.DA .PU .D1	
								.30	1616				
								.40	1682				

Reference order | 20018XX.SR.XX.XX.ST9.XX.XX

LUK FREIR 2	REF.	DIMENSIONS	FINISHES	LAMP	OPTIC OPTIONS	POWER	CRI	K	LUMEN	WATT	mA	DIMM*	SKETCH
	20019	.01	●	.LED	.40 .60	.ST	.9	.27	1660	18	350	.DA .PU .D1	
								.30	1690				
								.40	1790				
	20019	.02	●	.LED	.40 .60	.ST	.9	.27	2542	32	500	.DA .PU .D1	
								.30	3232				
								.40	3364				

Reference order | 20019.XX.SR.XX.XX.ST9.XX.XX

● Select finishes

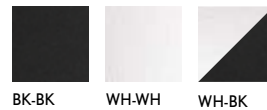

FINISHES

COLORS



DIMENSIONS

● View in family specifications

.01 | .02

LIGHTING OPTIONS

■ BEAM ANGLE

40° | 60°

POWER

STANDARD

CRI

90

COLOR TEMPERATURE

2700K | 3000K | 4000K

▼ DIMMABLE OPTIONS

DALI | 1.10 | PUSH

▲ LIGHT DISTRIBUTION

DOWN

ON DEMAND

Dim to Warm
Tunable White
Wireless Control Options



.SR

SURFACE

INSTALLATIONS

.SR
SURFACE

·20018 LUK FREIR ·20019 LUK FREIR 2 | SR
Pag. 344

.RF
RECESSED FRAME

·20018 LUK FREIR ·20019 LUK FREIR 2 | RF
Pag. 514

.TR
TRIMLESS

·20018 LUK FREIR ·20019 LUK FREIR 2 | TR
Pag. 680



PHOTOMETRY

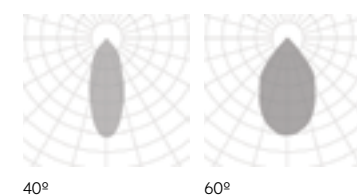

LUK
FREIR | FREIR 2

REF 20018.SR | REF 20019.SR

LUK CRUSADER	REF.	DIMENSIONS	FINISHES	LAMP	OPTIC OPTIONS	POWER	CRI	K	LUMEN	WATT	mA	DIMM OP.	SKETCH
	20082	.01	●	LED	.24 .40 .60	.ST	.9	.27 .30 .40	1633 2138 2228	20	700	.DA .PU .D1	

Reference order 20082.01.SR.XX.XX.ST9.XX.XX

● Select finishes

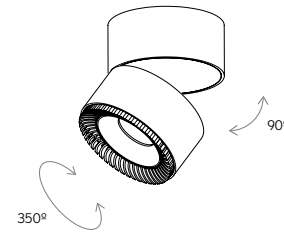

FINISHES

COLORS



DIMENSIONS

● View in family specifications

.01

LIGHTING OPTIONS

■ BEAM ANGLE

24° | 40° | 60°

POWER

STANDARD

CRI

90

COLOR TEMPERATURE

2700K | 3000K | 4000K

▼ DIMMABLE OPTIONS

DALI | 1.10 | PUSH

▲ LIGHT DISTRIBUTION

DOWN



INSTALLATIONS

.SR
SURFACE

·20082 LUK CRUSADER | SR
Pag. 346

.TK
TRACKLIGHT

·20082 LUK CRUSADER | TK
Pag. 752

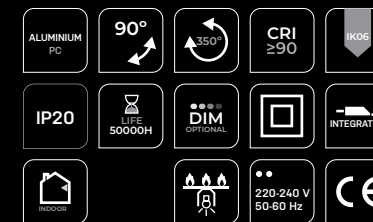

PHOTOMETRY

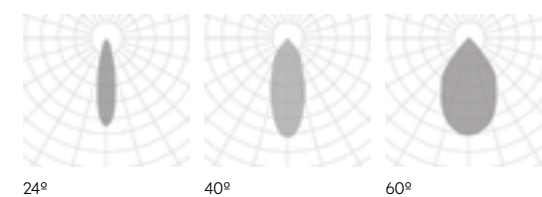

LUK CRUSADER

REF 20082.SR



.SR

SURFACE

LUK HAWKEYE	REF.	DIMENSIONS	FINISHES	LAMP	OPTIC OPTIONS	POWER	CRI	K	LUMEN	WATT	mA	DIMM OP.	SKETCH
	20083	.01	●	LED	.24 .40 .60	.ST	.9	.27	1633	20	700	.DA .PU .D1	
								.30	2138				
								.40	2228				

Reference order 20083.01.SR.XX.XX.ST9.XX.XX

LUK HAWKEYE 2	REF.	DIMENSIONS	FINISHES	LAMP	OPTIC OPTIONS	POWER	CRI	K	LUMEN	WATT	mA	DIMM OP.	SKETCH
	20084	.01	●	LED	.24 .40 .60	.ST	.9	.27	3266	40	700	.DA .PU .D1	
								.30	4276				
								.40	4456				

Reference order 20084.01.SR.XX.XX.ST9.XX.XX

● Select finishes

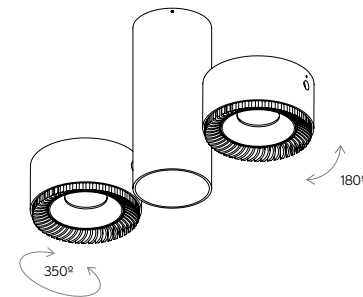

FINISHES

COLORS



DIMENSIONS

● View in family specifications

.01

LIGHTING OPTIONS

■ BEAM ANGLE

24° | 40° | 60°

POWER

STANDARD

CRI

90

COLOR TEMPERATURE

2700K | 3000K | 4000K

▼ DIMMABLE OPTIONS

DALI | 1.10 | PUSH

▲ LIGHT DISTRIBUTION

DOWN



.SR

SURFACE

INSTALLATIONS



.SR
SURFACE

·20083 HAWKEYE ·20084 HAWKEYE 2|SR
Pag. 348



.TK
TRACKLIGHT

·20083 HAWKEYE ·20084 HAWKEYE 2|TK
Pag. 754



PHOTOMETRY

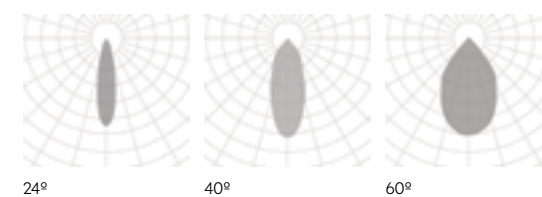

LUK HAWKEYE | HAWKEYE 2

REF 20083.SR | 20084.SR



CUBE TUBE	REF.	DIMEN-SIONS	FINISHES	LAMP	OPTIC OPTIONS	POWER	CRI	K	LUMEN	WATT	mA	DIMM OP.	SKETCH
	9050	.01	●	LED	.24 .40 .60	.ST	.9	.27 .30 .40	590 610 629	8	350	.DA .PU .D1	
	9050	.02	●	LED	.24 .40 .60	.ST	.9	.27 .30 .40	590 610 629	8	350	.DA .PU .D1	
	9050	.03	●	LED	.24 .40 .60	.ST	.9	.27 .30 .40	590 610 629	8	350	.DA .PU .D1	
	9050	.04	●	LED	.24 .40 .60	.ST	.9	.27 .30 .40	590 610 629	8	350	.DA .PU .D1	

Reference order **9050.XX** | **.SR** | **.PN** | **.XX.XX** | **.ST9** | **.XX.XX**

CUBE TUBE	REF.	DIMEN-SIONS	FINISHES	LAMP	OPTIC OPTIONS	POWER	CRI	K	LUMEN	WATT	mA	DIMM*	SKETCH
	9052	.01	●	LED	.24 .40 .60	.ST	.9	.27 .30 .40	1661 1819 1837	18	500	.DA .PU .D1	

Reference order **9052.01** | **.SR** | **.PN** | **.XX.XX** | **.ST9** | **.XX.XX**

● Select finishes

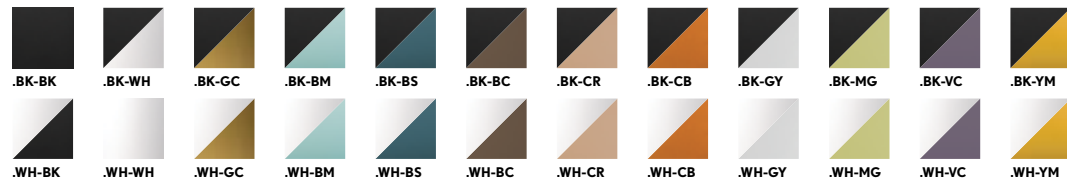

FINISHES

EXTERNAL COLOR



INTERNAL COLOR



DIMENSIONS

● View in family specifications

.01 | .02 | .03 | .04

LIGHTING OPTIONS

■ BEAM ANGLE

24° | 40° | 60°

POWER

STANDARD

CRI

90

COLOR TEMPERATURE

2700K | 3000K | 4000K

▼ DIMMABLE OPTIONS

DALI | 1.10 | PUSH

▲ LIGHT DISTRIBUTION

DOWN

INCLUDED (.PN)

Suspension cable 3m
Connection box with luminaire's finish

ON DEMAND

Dim to Warm
Tunable White
Wireless Control Options (Casambi)
Special RAL Color



.SR

.PN

PENDANT | SURFACE

INSTALLATIONS



.PN
PENDANT

·9050 | 9052 CUBE TUBE | PN
Pag. 350

.TK
TRACKLIGHT

·9050 CUBE TUBE | TK
Pag. 756

.SR
SURFACE

·9050 | 9052 CUBE TUBE | SR
Pag. 350



PHOTOMETRY

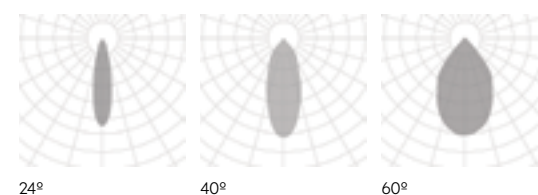

CUBE TUBE

REF 9050.SR | 9052.SR | 9050.PN | 9052.PN

CUBE TUBE MOVE	REF.	DIMENSIONS	FINISHES	LAMP	OPTIC OPTIONS	POWER	CRI	K	LUMEN	WATT	mA	DIMM OP.	SKETCH
	9051	.01	●	LED	.24 .40 .60	.ST	.9	.27 .30 .40	738 862 929	11	350	.DA .PU .D1	
	9051	.02	●	LED	.24 .40 .60	.ST	.9	.27 .30 .40	738 862 929	11	350	.DA .PU .D1	
	9051	.03	●	LED	.24 .40 .60	.ST	.9	.27 .30 .40	738 862 929	11	350	.DA .PU .D1	
	9051	.04	●	LED	.24 .40 .60	.ST	.9	.27 .30 .40	738 862 929	11	350	.DA .PU .D1	

Reference order | .SR | .PN | .XX.XX | .ST9 | .XX.XX

CUBE TUBE MOVE	REF.	DIMENSIONS	FINISHES	LAMP	OPTIC OPTIONS	POWER	CRI	K	LUMEN	WATT	mA	DIMM OP.	SKETCH
	9053	.01	●	LED	.24 .40 .60	.ST	.9	.27 .30 .40	1661 1819 1837	20	500	.DA .PU .D1	

Reference order | .SR | .PN | .XX.XX | .ST9 | .XX.XX

● Select finishes

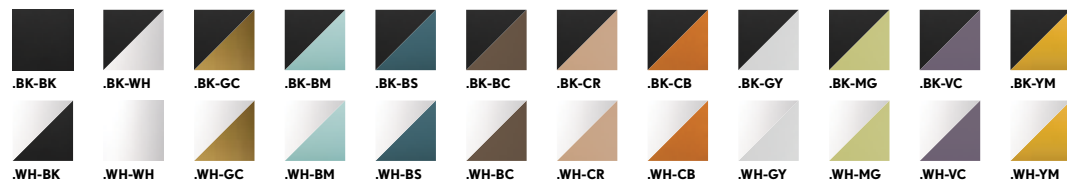

FINISHES

EXTERNAL COLOR



INTERNAL COLOR



DIMENSIONS

● View in family specifications

.01 | .02 | .03 | .04

LIGHTING OPTIONS

■ BEAM ANGLE

24° | 40° | 60°

POWER

STANDARD

CRI

90

COLOR TEMPERATURE

2700K | 3000K | 4000K

▼ DIMMABLE OPTIONS

DALI | 1.10 | PUSH

▲ LIGHT DISTRIBUTION

DOWN

INCLUDED (.PN)

Suspension cable 3m
Connection box with luminaire's finish

ON DEMAND

Dim to Warm
Tunable White
Wireless Control Options
Special RAL Color



INSTALLATIONS

.PN
PENDANT

· 9051 | 9053 TUBE MOVE | PN
Pag. 352

.SR
SURFACE

· 9051 | 9053 TUBE MOVE | SR
Pag. 352



PHOTOMETRY

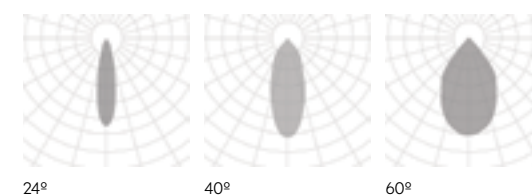

CUBE TUBE MOVE

REF 9051.SR | 9053.SR | 9051.PN | 9053.PN

.SR

.PN

PENDANT | SURFACE

CUBE SQ	REF.	DIMENSIONS	FINISHES	LAMP	OPTIC OPTIONS	POWER	CRI	K	LUMEN	WATT	mA	DIMM OP.	SKETCH
	8201	.01	●	LED	.24 .40 .60	.ST	.9	.27	738	11	350	.DA .PU .D1	
								.30	862				
								.40	929				

Reference order **8201.01.SR.XX.XX.ST9.XX.XX**

CUBE SQ2	REF.	DIMENSIONS	FINISHES	LAMP	OPTIC OPTIONS	POWER	CRI	K	LUMEN	WATT	mA	DIMM OP.	SKETCH
	8202	.01	●	LED	.24 .40 .60	.ST	.9	.27	1476	22	350	.DA .PU .D1	
								.30	1724				
								.40	1858				

Reference order **8202.01.SR.XX.XX.ST9.XX.XX**

CUBE SQ3	REF.	DIMENSIONS	FINISHES	LAMP	OPTIC OPTIONS	POWER	CRI	K	LUMEN	WATT	mA	DIMM OP.	SKETCH
	8203	.01	●	LED	.24 .40 .60	.ST	.9	.27	2214	33	350	.DA .PU .D1	
								.30	2586				
								.40	2787				

Reference order **8203.01.SR.XX.XX.ST9.XX.XX**

● Select external - internal finishes



FINISHES

EXTERNAL COLOR



INTERNAL COLOR



DIMENSIONS

● View in family specifications

.01 | .02

LIGHTING OPTIONS

■ BEAM ANGLE

24° | 40° | 60°

POWER

STANDARD

CRI

90

COLOR TEMPERATURE

2700K | 3000K | 4000K

▼ DIMMABLE OPTIONS

DALI | 1.10 | PUSH

▲ LIGHT DISTRIBUTION

DOWN

ON DEMAND

Dim to Warm
Tunable White
Wireless Control Options



INSTALLATIONS

.SR
SURFACE

·8201 CUBE ·8202 CUBE 2 ·8203 CUBE 3 | SR
Pag. 354

.RF
RECESSED FRAME

·8201 CUBE ·8202 CUBE 2 ·8203 CUBE 3 | RF
Pag. 518

.TR
TRIMLESS

·8201 CUBE ·8202 CUBE 2 ·8203 CUBE 3 | TR
Pag. 682



PHOTOMETRY

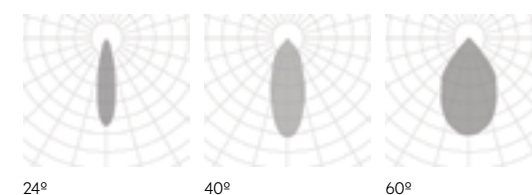

CUBE

SQ | SQ2 | SQ3

REF 8201.SR | REF 8202.SR | REF 8203.SR

SURFACE

CUBE SQ	REF.	DIMENSIONS	FINISHES	LAMP	OPTIC OPTIONS	POWER	CRI	K	LUMEN	WATT	mA	DIMM OP.	SKETCH
	8201	.02	●	LED	.24 .40 .60	.ST	.9	.27	1661	19	500	.DA .PU .D1	
								.30	1819				
								.40	1837				

Reference order 8201.02.SR.XX.XX.ST9.XX.XX

CUBE SQ2	REF.	DIMENSIONS	FINISHES	LAMP	OPTIC OPTIONS	POWER	CRI	K	LUMEN	WATT	mA	DIMM OP.	SKETCH
	8202	.02	●	LED	.24 .40 .60	.ST	.9	.27	3322	38	500	.DA .PU .D1	
								.30	3638				
								.40	3674				

Reference order 8202.02.SR.XX.XX.ST9.XX.XX

CUBE SQ3	REF.	DIMENSIONS	FINISHES	LAMP	OPTIC OPTIONS	POWER	CRI	K	LUMEN	WATT	mA	DIMM OP.	SKETCH
	8203	.02	●	LED	.24 .40 .60	.ST	.9	.27	4983	58	500	.DA .PU .D1	
								.30	5457				
								.40	5511				

Reference order 8203.02.SR.XX.XX.ST9.XX.XX

● Select external - internal finishes



FINISHES

EXTERNAL COLOR



INTERNAL COLOR



DIMENSIONS

● View in family specifications

.01 | .02

LIGHTING OPTIONS

■ BEAM ANGLE

24° | 40° | 60°

POWER

STANDARD

CRI

90

COLOR TEMPERATURE

2700K | 3000K | 4000K

▼ DIMMABLE OPTIONS

DALI | 1.10 | PUSH

▲ LIGHT DISTRIBUTION

DOWN

ON DEMAND

Dim to Warm
Tunable White
Wireless Control Options



INSTALLATIONS

.SR
SURFACE

·8201 CUBE ·8202 CUBE 2 ·8203 CUBE 3 | SR
Pag. 354

.RF
RECESSED FRAME

·8201 CUBE ·8202 CUBE 2 ·8203 CUBE 3 | RF
Pag. 518

.TR
TRIMLESS

·8201 CUBE ·8202 CUBE 2 ·8203 CUBE 3 | TR
Pag. 682



PHOTOMETRY

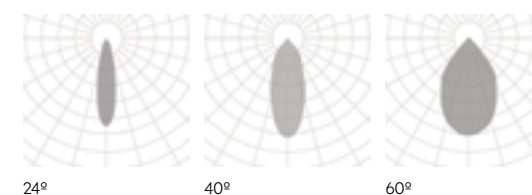

CUBE

SQ | SQ2 | SQ3

REF 8201.SR | REF 8202.SR | REF 8203.SR

SURFACE

CATLI	REF.	DIMENSIONS	FINISHES	LAMP	OPTIC OPTIONS	POWER	CRI	K	LUMEN*2	WATT	mA	DIMM*1	SKETCH	
	3010	.01	●	GU10	.GU					Max 8				
				LED	.40 .60		.ST	.9	.27	526	8	350		.DA .PU .D1
									.30	570				
.40	627													

Reference order 3010.01.SR.XX.XX.XX.X.XX.XX

CATLI SQ	REF.	DIMENSIONS	FINISHES	LAMP	OPTIC OPTIONS	POWER	CRI	K	LUMEN*2	WATT	mA	DIMM*1	SKETCH	
	3011	.01	●	GU10	.GU					Max 8				
				LED	.40 .60		.ST	.9	.27	526	8	350		.DA .PU .D1
									.30	570				
.40	627													

Reference order 3011.01.SR.XX.XX.XX.X.XX.XX

● Select internal - external finishes

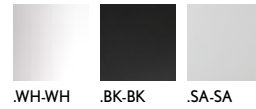

*1 Remote driver when dimmable. *Driver remoto cuando es dimable.*

*2 Please might expect max. 15% value reduction in finishes other than white. / Puede haber una reducción máx. del 15% en el dato de los acabados al blanco.

FINISHES

COLOR



DIMENSIONS

● View in family specifications

.01

LIGHTING OPTIONS

■ BEAM ANGLE / LAMP

40° | 60° | GU10

POWER

STANDARD

CRI

90

COLOR TEMPERATURE

2700K | 3000K | 4000K

▼ DIMMABLE OPTIONS

DALI | 1.10 | PUSH

▲ LIGHT DISTRIBUTION

DOWN

ON DEMAND

Dim to Warm
Tunable White
Wireless Control Options



INSTALLATIONS



CATLI | CATLI SQ

REF 3010.SR | 3011.SR

.SR
SURFACE

-3010 CATLI|SR -3011 CATLI SQ|SR
Pag. 358

.RF
RECESSED FRAME

-3010 CATLI|RF -3011 CATLI SQ|RF
Pag. 560

PHOTOMETRY

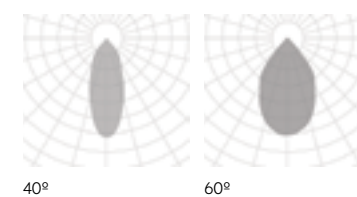

.SR

SURFACE



ORACLE	REF.	DIMENSIONS	FINISHES	LAMP	OPTIC OPTIONS	POWER	CRI	K	LUMEN	WATT	mA	DIMM	SKETCH
	20087	.01	●	LED	.24 .40 .60	.ST	.9	.27 .30 .40	1079 1216 1273	14	500	.DA .PU .D1	

Reference order | 20087.01.SR.XX.XX.ST.9.XX.XX

• Select finishes

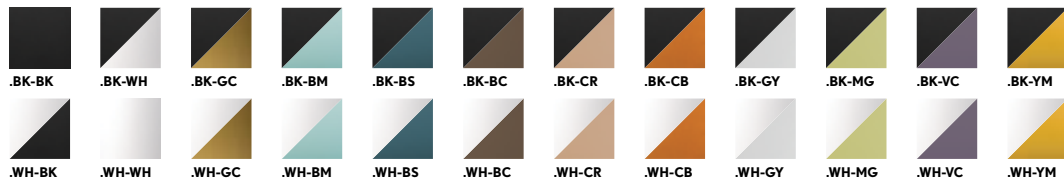

• FINISHES

EXTERNAL COLOR



INTERNAL COLOR



DIMENSIONS

• View in family specifications

.01

LIGHTING OPTIONS

■ BEAM ANGLE

24° | 40° | 60°

POWER

STANDARD

CRI

90

COLOR TEMPERATURE

2700K | 3000K | 4000K

▼ DIMMABLE OPTIONS

DALI | 1.10 | PUSH

▲ LIGHT DISTRIBUTION

DOWN

INCLUDED (.PN)

Suspension cable 3m
Connection box with luminaire's finish

ON DEMAND

Dim to Warm
Tunable White
Wireless Control Options



PENDANT | SURFACE

INSTALLATIONS



.PN
PENDANT

·20087 ORACLE|PN
Pag. 358

.TK
TRACKLIGHT

·20087 ORACLE|TK
Pag. 758

.SR
SURFACE

·20087 ORACLE|SR
Pag. 358

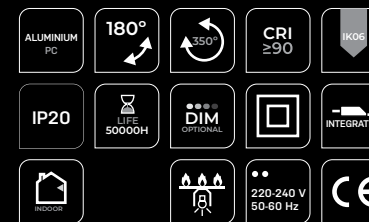

PHOTOMETRY

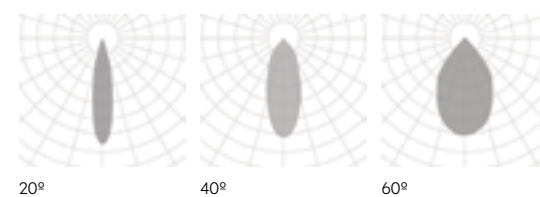

ORACLE

REF 20087.SR | 20087.PN



new

FACE TUBULAR	REF.	DIMENSIONS	FINISHES	LAMP	OPTIC OPTIONS	POWER	CRI	K	LUMEN	WATT	mA	DIMM *1	SKETCH
	20205	.01	●	LED	.40	.ST	.9	.27	480	8	350	.DA .PU .D1	
								.30	493				
								.40	496				

Reference order  20205.01.SR.XX.XX.ST9.XX.XX

● Select external-internal finishes

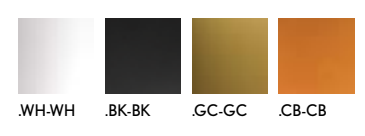

*1 Remote driver when dimmable. *Driver remoto cuando es dimable.*

FINISHES

COLORS



DIMENSIONS

● View in family specifications

.01

LIGHTING OPTIONS

■ BEAM ANGLE

40°

POWER

STANDARD

CRI

90

COLOR TEMPERATURE

2700K | 3000K | 4000K

▼ DIMMABLE OPTIONS

DALI | 1.10 | PUSH

▲ LIGHT DISTRIBUTION

DOWN

ON DEMAND

Wireless Control Options
Special RAL Color



INSTALLATIONS

.SR
SURFACE

·20205 FACE TUBULAR | SR
Pag. 360

.RF
RECESSED FRAME

·20205 FACE TUBULAR | RF
Pag. 506

- ALUMINIUM PC
- 90°
- 350°
- CRI ≥ 90
- IK05
- IP20
- LIFE 50000H
- DIM OPTIONAL
- INTEGRATED
- INDOOR
- 220-240 V 50-60 Hz
- CE

PHOTOMETRY



40°



SURFACE .SR

FACE TUBULAR

REF 20205.SR

new

FACE TUBULAR	REF.	DIMENSIONS	FINISHES	LAMP	OPTIC OPTIONS	POWER	CRI	K	LUMEN	WATT	mA	DIMM *1	SKETCH
	20205	.01	●	LED	.40	.ST	.9	.27	633	11	500	.DA .PU .D1	
								.30	678				
								.40	701				

	20205	.02	●	LED	.40	.ST	.9	.27	633	11	500	.DA .PU .D1	
								.30	678				
								.40	701				

Reference order | 20205.XX.PN.XX.XX.ST9.XX.XX

● Select external-internal finishes



FINISHES

COLORS



DIMENSIONS

● View in family specifications

.01 | .02

LIGHTING OPTIONS

■ BEAM ANGLE

40°

POWER

STANDARD

CRI

90

COLOR TEMPERATURE

2700K | 3000K | 4000K

▼ DIMMABLE OPTIONS

DALI | 1.10 | PUSH

▲ LIGHT DISTRIBUTION

DOWN

INCLUDED

Suspension cable 1.5m
Connection box with luminaire's finish

ON DEMAND

Wireless Control Options
Special RAL Color



INSTALLATIONS



.PN
PENDANT

·20205 FACETUBULAR | PN
Pag. 364

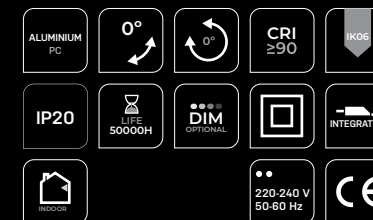

PHOTOMETRY



40°

FACE TUBULAR

REF 20205.PN



new

FACE TUBULAR SPAC	REF.	DIMENSIONS	FINISHES	LAMP	OPTIC OPTIONS	POWER	CRI	K	LUMEN	WATT	mA	DIMM *1	SKETCH
	20207	.01	●	LED	.40	.ST	.9	.27	1059	16	700	.DA .PU .D1	
								.30	1062				
								.40	1108				

	20207	.02	●	LED	.40	.ST	.9	.27	1059	16	700	.DA .PU .D1	
								.30	1062				
								.40	1108				

Reference order | 20207.XX.PN.XX.XX.ST.9.XX.XX

● Select external-internal finishes

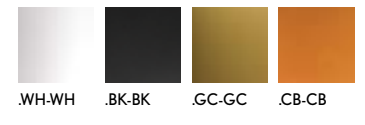

*1 Remote driver when dimmable. Driver remoto cuando es dimable.

FINISHES

COLORS



DIMENSIONS

View in family specifications

.01 | .02

LIGHTING OPTIONS

BEAM ANGLE

40°

POWER

STANDARD

CRI

90

COLOR TEMPERATURE

2700K | 3000K | 4000K

DIMMABLE OPTIONS

DALI | 1.10 | PUSH

LIGHT DISTRIBUTION

DOWN

INCLUDED

Suspension cable 1.5m
Connection box with luminaire's finish

ON DEMAND

Wireless Control Options
Special RAL Color



.PN

PENDANT

INSTALLATIONS



- ALUMINIUM PC
- 0°
- 0°
- CRI ≥ 90
- IP20
- LIFE 50000H
- DIM OPTIONAL
- INTEGRATED
- 220-240 V 50-60 Hz
- CE

FACE TUBULAR SPAC

REF 20207.PN

PHOTOMETRY



40°



FACE KIERA	REF.	DIMEN-SIONS	FINISHES	LAMP	OPTIC OPTIONS	POWER	CRI	K	LUMEN	WATT	mA	DIMM *1	SKETCH
	20204	.01	●	LED	.38	.ST	.9	.27	411	5	500	.DA .PU .D1	
								.30	447				
								.40	488				
	20204	.02	●	LED	.38	.ST	.9	.27	572	8	700	.DA .PU .D1	
								.30	574				
								.40	594				
	20204	.03	●	LED	.38	.ST	.9	.27	1396	18	500	.DA .PU .D1	
								.30	1655				
								.40	1962				

Reference order | 20204.XX.PN.XX.XX.ST9.XX.XX

● Select external-internal finishes



*1 Remote driver when dimmable. *Driver remoto cuando es dimable.*

FINISHES

COLORS



DIMENSIONS

View in family specifications

.01 | .02 | .03

LIGHTING OPTIONS

BEAM ANGLE

38°

POWER

STANDARD

CRI

90

COLOR TEMPERATURE

2700K | 3000K | 4000K

DIMMABLE OPTIONS

DALI | 1.10 | PUSH

LIGHT DISTRIBUTION

DOWN

INCLUDED

Suspension cable 1.5m
Connection box with luminaire's finish

ON DEMAND

Wireless Control Options



.PN

PENDANT

INSTALLATIONS



.PN
PENDANT

·20204 FACE KIERA | PN
Pag. 368

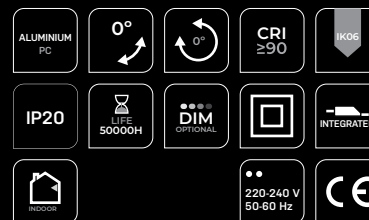

PHOTOMETRY



38°

FACE KIERA

REF 20204.PN

KIERA CEMENT	REF.	DIMENSIONS	FINISHES	LAMP	OPTIC OPTIONS	POWER	CRI	K	LUMEN	WATT	mA	DIMM *1	SKETCH
	20208	.01	.BK-GY	LED	.38	.ST	.9	.27	411	5	500	.DA .PU .D1	
								.30	447				
								.40	488				
	20208	.02	.BK-GY	LED	.38	.ST	.9	.27	572	7	700	.DA .PU .D1	
								.30	574				
								.40	594				
	20208	.03	.BK-GY	LED	.38	.ST	.9	.27	1396	18	500	.DA .PU .D1	
								.30	1655				
								.40	1962				

Reference order | 20208.XX.PN.BK-GY.XX.ST.9.XX.XX

FINISHES

COLORS



DIMENSIONS

View in family specifications

.01 | .02 | .03

LIGHTING OPTIONS

BEAM ANGLE

38°

POWER

STANDARD

CRI

90

COLOR TEMPERATURE

2700K | 3000K | 4000K

DIMMABLE OPTIONS

DALI | 1.10 | PUSH

LIGHT DISTRIBUTION

DOWN

INCLUDED

Suspension cable 1.5m
Connection box with luminaire's finish

ON DEMAND

Wireless Control Options



.PN

PENDANT

*1 Remote driver when dimmable. Driver remoto cuando es dimable.

INSTALLATIONS

- ALUMINIUM PC
- 0°
- 0°
- CRI ≥90
- IP20
- LIFE 50000H
- DIM OPTIONAL
- INTEGRATED
- INDOOR
- 220-240 V 50-60 Hz
- CE

FACE KIERA CEMENT

REF 20208.PN

PHOTOMETRY



38°

.PN
PENDANT

·20208 FACE KIERA CEMENT | PN
Pag. 370

new

FACE IRIS	REF.	DIMENSIONS	FINISHES	LAMP	OPTIC OPTIONS	POWER	CRI	K	LUMEN	WATT	mA	DIMM *1	SKETCH
	20203	.01	●	LED	.60	.ST	.9	.27	817	10	500	.DA .PU .D1	
								.30	852				
								.40	962				
	20203	.02	●	LED	.60	.ST	.9	.27	1504	20	500	.DA .PU .D1	
								.30	1811				
								.40	1858				
	20203	.03	●	LED	.60	.ST	.9	.27	1837	29	700	.DA .PU .D1	
								.30	2264				
								.40	2373				

Reference order | 20203.XX.PN.XX.XX.ST.9.XX.XX

● Select external-internal finishes

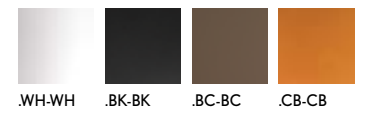

*1 Remote driver when dimmable. Driver remoto cuando es dimable.

FINISHES

COLORS



DIMENSIONS

View in family specifications

.01 | .02 | .03

LIGHTING OPTIONS

BEAM ANGLE

60°

POWER

STANDARD

CRI

90

COLOR TEMPERATURE

2700K | 3000K | 4000K

DIMMABLE OPTIONS

DALI | 1.10 | PUSH

LIGHT DISTRIBUTION

DOWN

INCLUDED

Suspension cable 1.5m
Connection box with luminaire's finish

ON DEMAND

Wireless Control Options
Special RAL Color



INSTALLATIONS



.PN
PENDANT

·20203 FACE IRIS | PN
Pag. 372

- ALUMINIUM PC
- 0°
- 0°
- CRI ≥90
- IK05
- IP20
- LIFE 50000H
- DIM OPTIONAL
- INTEGRATED
- INDOOR
- 220-240 V 50-60 Hz
- CE

PHOTOMETRY



60°



FACE IRIS

REF 20203.PN

PENDANT

SUBLIM	REF.	DIMENSIONS	FINISHES	LAMP	OPTIC OPTIONS	POWER	CRI	K	LUMEN	WATT	mA	DIMM *1	SKETCH
	20206	.01	●	LED	.36	.ST	.9	.27	467	9	350	.DA .PU .D1	
								.30	471				
								.40	511				
	20206	.02	●	LED	.36	.ST	.9	.27	467	9	350	.DA .PU .D1	
								.30	471				
								.40	511				
	20206	.03	●	LED	.36	.ST	.9	.27	467	9	350	.DA .PU .D1	
								.30	471				
								.40	511				

Reference order | 20206.XX.PN.XX.XX.ST9.XX.XX

● Select external-internal finishes

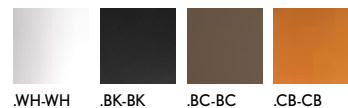

*1 Remote driver when dimmable. *Driver remoto cuando es dimable.*

FINISHES

COLORS



DIMENSIONS

● View in family specifications

.01 | .02 | .03

LIGHTING OPTIONS

■ BEAM ANGLE

36°

POWER

STANDARD

CRI

90

COLOR TEMPERATURE

2700K | 3000K | 4000K

▼ DIMMABLE OPTIONS

DALI | 1.10 | PUSH

▲ LIGHT DISTRIBUTION

DOWN

INCLUDED

Suspension cable 1.5m
Connection box with luminaire's finish

ON DEMAND

Wireless Control Options
Special RAL Color



.PN

PENDANT

INSTALLATIONS



.PN
PENDANT

·20206 SUBLIM|PN
Pag. 374

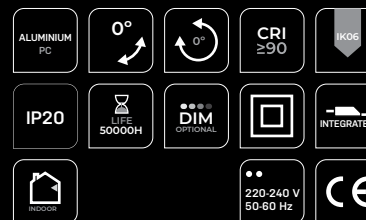

SUBLIM

REF 20206.PN

PHOTOMETRY



36°



GALANTA BONETE	REF.	DIMEN-SIONS	FINISHES	LAMP	DIFFUSER	POWER	CRI	K	LUMEN	WATT	mA	DIMM *1	SKETCH
	20222	.01	●	LED	.OP	.ST	.9	.27	419	6	500	.DA .PU .D1	
							.30	474					
							.40	510					

Reference order 20222.01.PN.XX.XX.ST9.XX.XX

● Select finishes

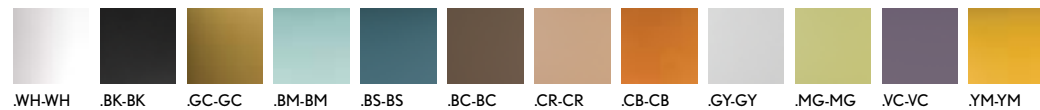

*1 Remote driver when dimmable. Driver remoto cuando es dimable.

FINISHES

COLORS



DIMENSIONS

View in family specifications

.01

LIGHTING OPTIONS

DIFFUSER

OPAL

POWER

STANDARD

CRI

90

COLOR TEMPERATURE

2700K | 3000K | 4000K

DIMMABLE OPTIONS

DALI | 1.10 | PUSH

LIGHT DISTRIBUTION

DOWN

INCLUDED

Suspension cable 1.5m
Connection box with luminaire's finish

ON DEMAND

Wireless Control Options



.PN

PENDANT

INSTALLATIONS



.PN
PENDANT

20222 GALANTA BONETE | PN
Pag. 376

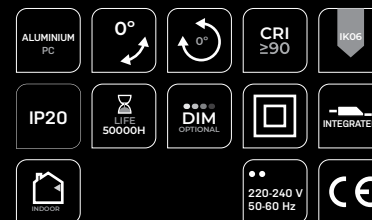

GALANTA BONETE

REF 20222.PN







PHOTOMETRY

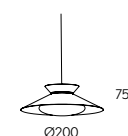

OPAL

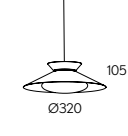

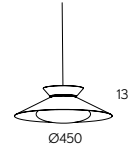
new

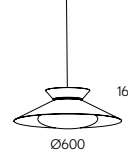
VENISE	REF.	DIMEN-SIONS	FINISHES	LAMP	OPTIC OPTIONS	POWER	CRI	K	LUMEN	WATT	mA	DIMM	SKETCH
	410011	.01	●	LED	.OP	.ST	.9	.30	583	12	500	.DA .PU .D1	 75 Ø200
	410011	.02	●	LED	.OP	.ST	.9	.30	1302	16	500	.DA .PU .D1	 105 Ø320
	410011	.03	●	LED	.OP	.ST	.9	.30	1343	30	700	.DA .PU .D1	 135 Ø450
	410011	.04	●	LED	.OP	.ST	.9	.30	2111	45	1050	.DA .PU .D1	 165 Ø600

Reference order | 410011.XX.PN.XX.XX.ST9.XX.XX

Select finishes

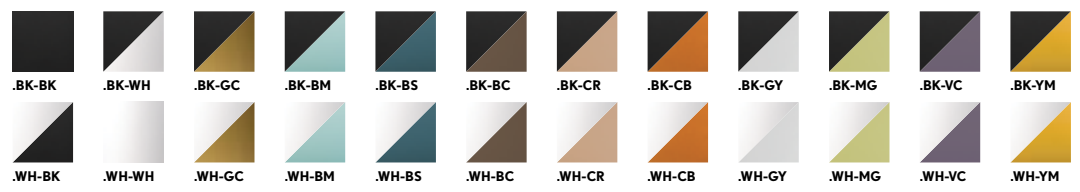

FINISHES

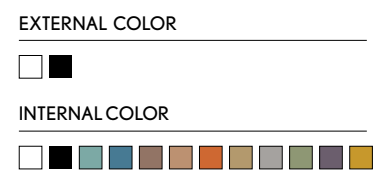

DIMENSIONS

View in family specifications

.01

LIGHTING OPTIONS

- DIFFUSER
 - OPAL
- POWER
 - STANDARD
- CRI
 - 90
- COLOR TEMPERATURE
 - 3000K
- DIMMABLE OPTIONS
 - DALI | 1.10 | PUSH
- LIGHT DISTRIBUTION
 - DOWN

INCLUDED

Suspension cable 1.5m
Connection box with luminaire's finish



PENDANT

INSTALLATIONS

.PN
PENDANT

-410011 VENISE | PN
Pag. 378



VENISE

REF 410011.PN

PHOTOMETRY



CONNECTION BOXES

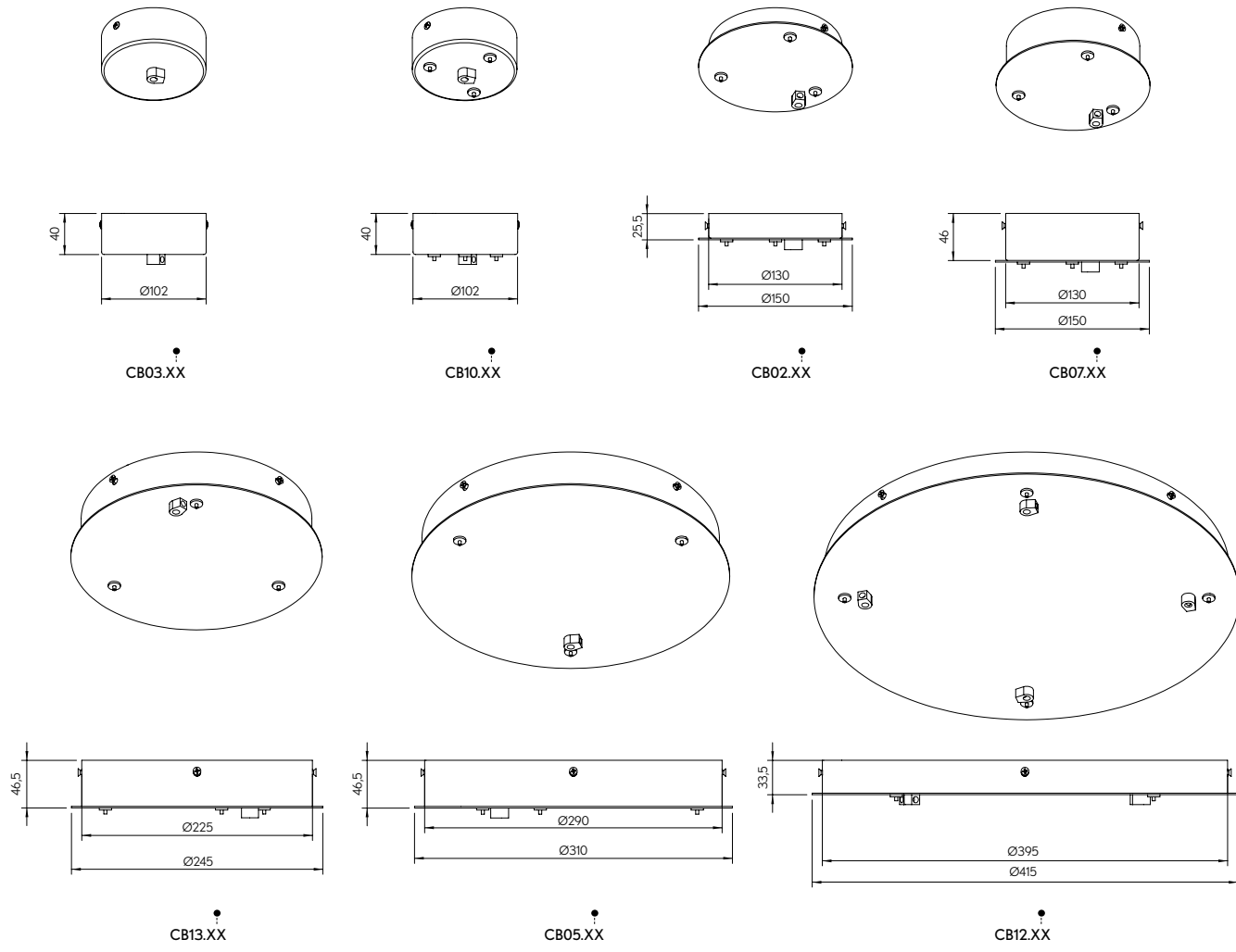

CONNECTION & DRIVER BOXES

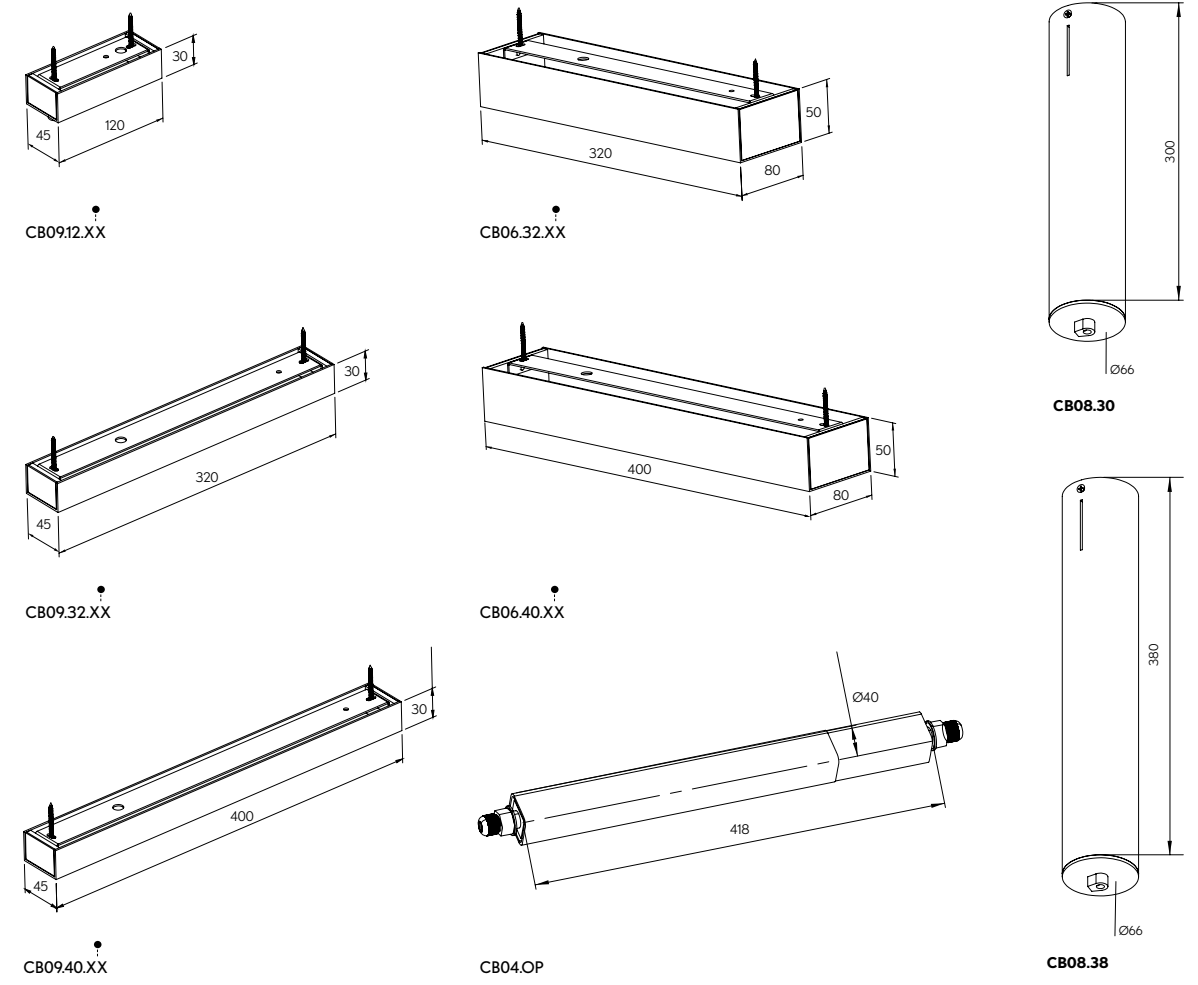

Select finishes



ACCESORIES

SUSPENSION ACCESORIES

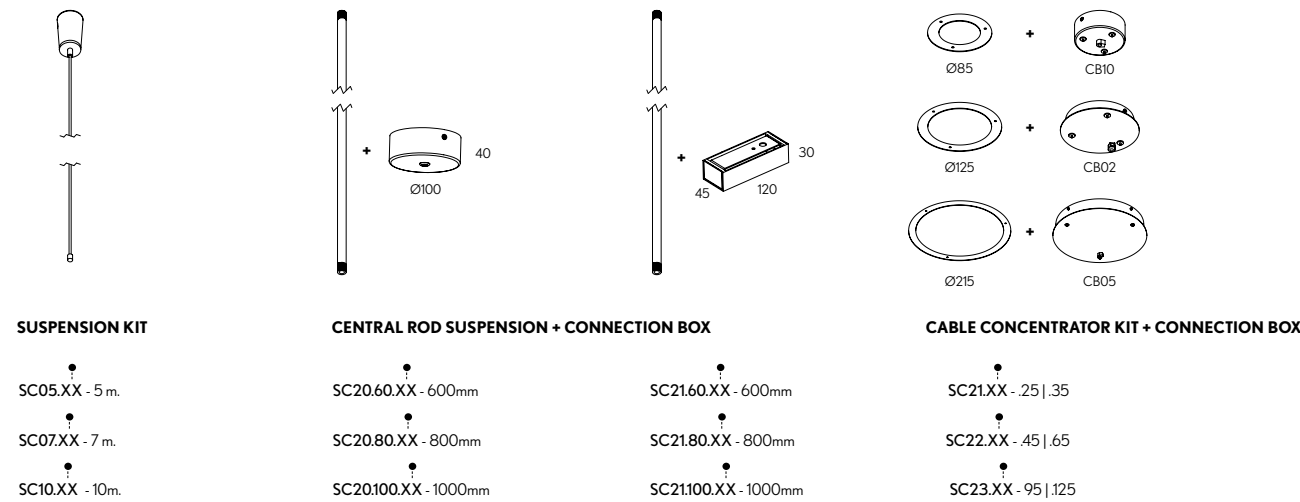

INDIVIDUAL CEILING RECESSED ACCESSORIES

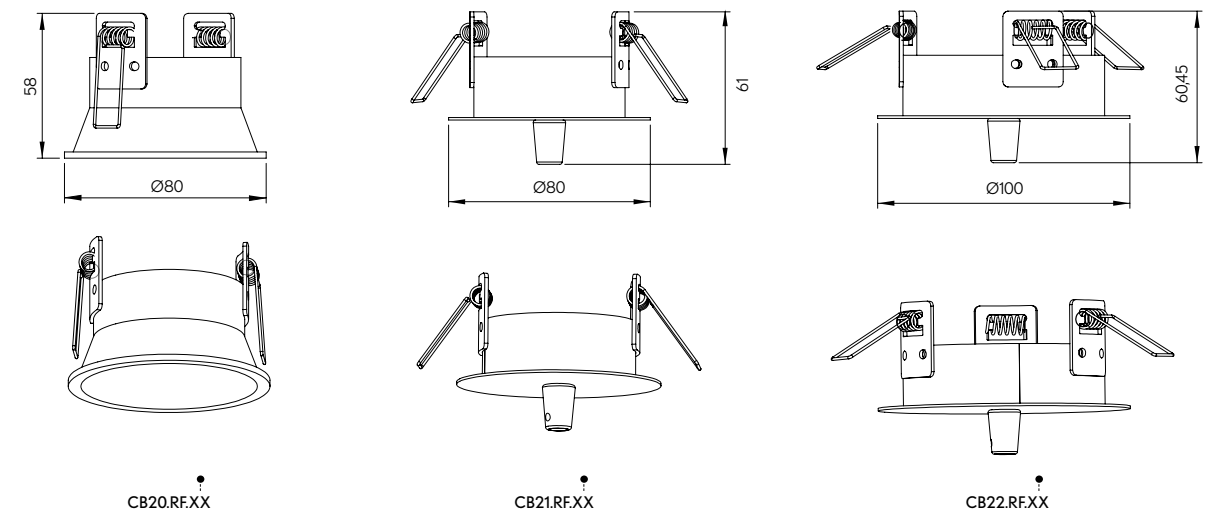

* Check luminaire's compatibility. Consultar compatibilidad con la luminaria.

The invisible star *El protagonista invisible*

The imperceivable force behind the project. An entity in its own right, whose only purpose is to enhance the ambiance, never draw attention to itself. Meet the White Structural Collection, a minimalist design featuring Crismosil, an innovative, exclusive material that integrates seamlessly in any space.

Ser el foco de atención sin ser visto. Una función en sí misma, con el único fin de dejar todo el protagonismo al espacio, nunca a la luminaria. Así se presenta la colección White Structural, resultado de un diseño minimalista y fruto de la producción exclusiva con Crismosil, un innovador material que permite una completa integración en los espacios.



STRUCTURAL

SURFACE

NOCTUA	REF.	DIMENSIONS	FINISHES	LAMP	OPTIC OPTIONS	POWER	CRI	K	LUMEN	WATT	mA	DIMM *1	SKETCH			
	10103	.01	.WH-WH	GU10	.GU	GU10	.9	-	526	Max 8	350	.DA .PU .D1				
				LED	.40 .60	.ST BPM50								.27	570	8
						.40									711	

NOCTUA	REF.	DIMENSIONS	FINISHES	LAMP	OPTIC OPTIONS	POWER	CRI	K	LUMEN	WATT	mA	DIMM *1	SKETCH			
	10103	.02	.WH-WH	GU10	.GU	GU10	.9	-	526	Max 8	350	.DA .PU .D1				
				LED	.40 .60	.ST BPM50								.27	570	8
						.40									711	

NOCTUA	REF.	DIMENSIONS	FINISHES	LAMP	OPTIC OPTIONS	POWER	CRI	K	LUMEN	WATT	mA	DIMM	SKETCH			
	10103	.03	.WH-WH	GU5.3		GU5.3	.9	-	1538	Max 20	500	.DA .PU .D1				
				GU10	.GU	GU10								.27	1722	16
				GX8.5	.CD	GX8.5								.30	1355	
				LED	.40 .60	.ST BPM3181								.40		

30° 10103.01 · 10103.02

45° 10103.03

LUMINAIRE INCLUDES

Surface mounting kit

Reference order

10103.XX.SR.WH-WH.XX.XX.X.XX.XX

*1 Remote driver when dimmable. *Driver remoto cuando es dimable.*

FINISHES



DIMENSIONS

.01 | .02 | .03

LIGHTING OPTIONS

BEAM ANGLE / LAMP

40 | 60
GU5.3 | GU10 | GX8.5

POWER

STANDARD | HIGH

CRI

90

COLOR TEMPERATURE

2700K | 3000K | 4000K

DIMMABLE OPTIONS

DALI | 1.10 | PUSH

LIGHT DISTRIBUTION

DOWN

ON DEMAND

Wireless Control Options



CRISMOSIL

SURFACE

NOCTUA

REF 10103.SR

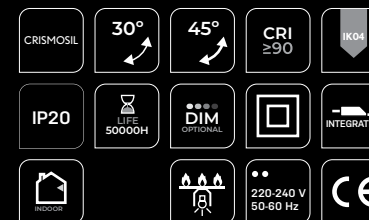

PHOTOMETRY

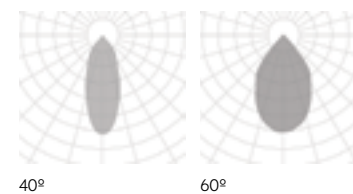

40°

60°

NOCTUA SQ	REF.	DIMENSIONS	FINISHES	LAMP	OPTIC OPTIONS	POWER	CRI	K	LUMEN	WATT	mA	DIMM *1	SKETCH
	10099	.01	.WH-WH	GU5.3		GU5.3	.9	.27	526	8	350	.DA .PU .D1	
				GU10	.GU	GU10			570				
				LED	.40 .60	.ST BPM50			711				

NOCTUA SQ	REF.	DIMENSIONS	FINISHES	LAMP	OPTIC OPTIONS	POWER	CRI	K	LUMEN	WATT	mA	DIMM	SKETCH
	10099	.02	.WH-WH	GU10	.GU	GU10	.9	.27	1538	16	500	.DA .PU .D1	
				GX8.5	.CD	GX8.5			1722				
				LED	.40 .60	.ST BPM3181			1355				

- 10099.01
- 10099.02

LUMINAIRE INCLUDES

Surface mounting kit

Reference order

10099.XX.SR.WH-WH.XX.XX.X.XX.XX

*1 Remote driver when dimmable. Driver remoto cuando es dimable.

FINISHES

DIMENSIONS

.01 | .02

LIGHTING OPTIONS

BEAM ANGLE / LAMP

40 | 60
GU5.3 | GU10 | GX8.5

POWER

STANDARD

CRI

90 |

COLOR TEMPERATURE

2700K | 3000K | 4000K

DIMMABLE OPTIONS

DALI | 1.10 | PUSH

LIGHT DISTRIBUTION

DOWN

ON DEMAND

Wireless Control Options

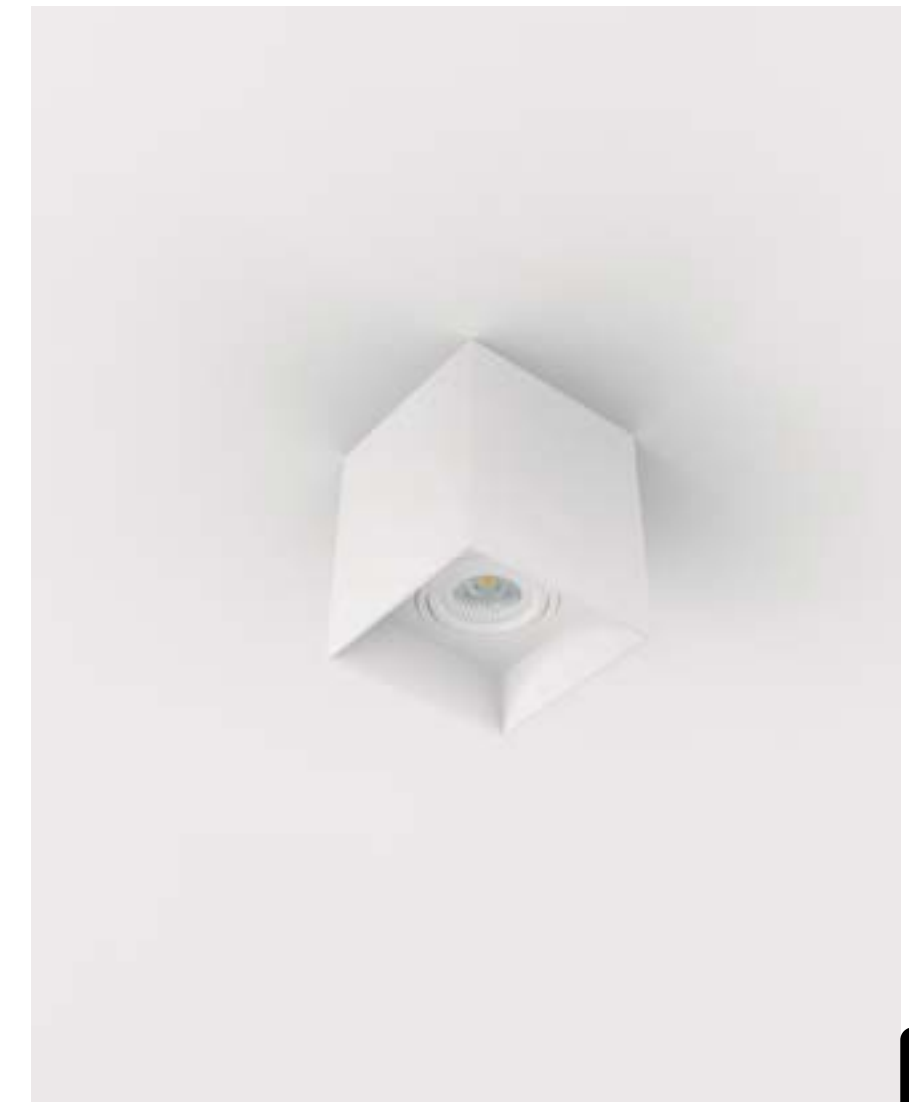

CRISMOSIL

.SR

SURFACE

- CRISMOSIL
- 30°
- 45°
- CRI ≥90
- IK04
- IP20
- LIFE 50000H
- DIM OPTIONAL
- INTEGRATED
- INDOOR
- 220-240 V 50-60 Hz
- CE

NOCTUA SQ

REF 10099.SR

PHOTOMETRY

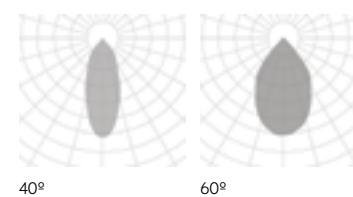

40°

60°

NOCTUA DEEP	REF.	DIMENSIONS	FINISHES	LAMP	OPTIC OPTIONS	POWER	CRI	K	LUMEN	WATT	mA	DIMM *1	SKETCH			
	10100	.01	.WH-WH	GU5.3		GU5.3	.9	.27 .30 .40 .27 .30 .40	526	Max 8	-	-				
				GU10	.GU	GU10			570							
				LED	.40 .60	.ST BPM50			10	350						
										.HI BPM300				711	500	.DA .PU .D1
														707		
														927		
767																

FINISHES



DIMENSIONS

.01

LIGHTING OPTIONS

BEAM ANGLE / LAMP

40 | 60
GU5.3 | GU10

POWER

STANDARD | HIGH

CRI

90

COLOR TEMPERATURE

2700K | 3000K | 4000K

DIMMABLE OPTIONS

DALI | 1.10 | PUSH

LIGHT DISTRIBUTION

DOWN

ON DEMAND

Wireless Control Options

LUMINAIRE INCLUDES

Con difusor opal.
With opal optic cover.

Surface mounting kit

Reference order

10100.01.SR.WH-WH.XX.XX.X.XX.XX

*1 Remote driver when dimmable. *Driver remoto cuando es dimable.*



CRISMOSIL

SURFACE



NOCTUA DEEP

REF 10100.SR

PHOTOMETRY

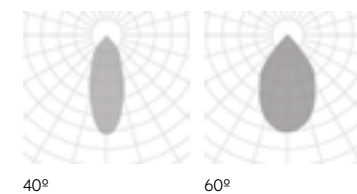

40°

60°

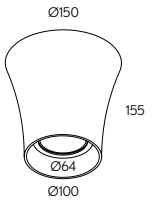
NOCTUA VENUS	REF.	DIMENSIONS	FINISHES	LAMP	OPTIC OPTIONS	POWER	CRI	K	LUMEN	WATT	mA	DIMM *1	SKETCH		
	10102	.01	.WH-WH	GU5.3		GU5.3	.9	-	526	Max 8	350	.DA .PU .D1			
				GU10	.GU	GU10									
				LED	.40 .60	.ST BPM50				.27				526	8
										.30				570	
										.27				711	
										.30				927	
			.HI BPM300	.40	767										

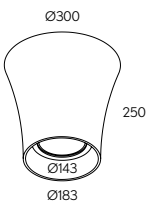
NOCTUA VENUS	REF.	DIMENSIONS	FINISHES	LAMP	OPTIC OPTIONS	POWER	CRI	K	LUMEN	WATT	mA	DIMM	SKETCH	
	10102	.02	.WH-WH	GU10	.GU	GU10	.9	-	1538	Max 20	500	.DA .PU .D1		
				GX8.5	.CD	GX8.5				Max 20				
				LED	.40 .60	.ST BPM3181				.27				1538
										.30				1722
										.40				1355

30° 10102.01

45° 10102.02

LUMINAIRE INCLUDES

Surface mounting kit

Reference order

10102.XX.SR.WH-WH.XX.XX.X.XX.XX

*1 Remote driver when dimmable. Driver remoto cuando es dimable.

FINISHES

□

DIMENSIONS

.01

LIGHTING OPTIONS

BEAM ANGLE / LAMP

40 | 60

GU5.3 | GU10 | GX8.5

POWER

STANDARD

CRI

90

COLOR TEMPERATURE

2700K | 3000K | 4000K

DIMMABLE OPTIONS

DALI | 1.10 | PUSH

LIGHT DISTRIBUTION

DOWN

ON DEMAND

Wireless Control Options



CRISMOSIL

SURFACE

- CRISMOSIL
- 30°
- 45°
- CRI ≥90
- IK04
- IP20
- LIFE 50000H
- DIM OPTIONAL
- INTEGRATED
- RECOOR
- 220-240 V 50-60 Hz
- CE

NOCTUA VENUS

REF 10102.SR



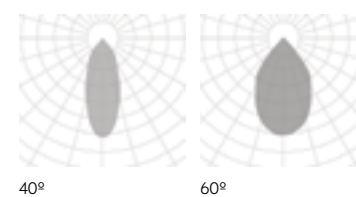



























PHOTOMETRY











































40°

60°

RECESSED WITH FRAME

ALABAMA	 ALABAMA 10158 PAG. 396	OHIO	 OHIO 10188 PAG. 400	 OHIO SO 10204 PAG. 404		
FLORIDA	 FLORIDA 10190 PAG. 408	 FLORIDA SO 10191 PAG. 412	ALBERTA	 ALBERTA SOFT 10217 PAG. 416	 ALBERTA 10176 PAG. 420	
ALARIK	 ALARIK SLIM 20224 PAG. 428	MODULIGHT	 MODULIGHT 10210 PAG. 434			
ALBA	 ALBA MINI 10211 PAG. 440	 ALBA 10160 PAG. 444	 ALBA ASIMETRIC 210009 PAG. 448	 ALBA PLUS 10178 PAG. 452	 ALBA PLUS ASIMETRIC 210008 PAG. 456	
BOLD	 BOLD 210001 PAG. 460	 BOLD LINE 210015 PAG. 460	WING	 WING 10200 PAG. 464		
OKKO MODULAR	 OKKO MODULAR 410012 PAG. 468	 OKKO PLUS MODULAR 410013 PAG. 470	LENT	 LENT MODULAR 10216 PAG. 472	 LENT MOTION 10212 PAG. 474	
VIO	 VIO 20185 PAG. 488	 VIO DEEP 20186 PAG. 488	 VIO DOME 20183 PAG. 488	 VIO SO 20181 PAG. 488	 VIO MOVE 20184 PAG. 488	 VIO DEEP MOVE 20187 PAG. 488
 VIO DOME MOVE 20182 PAG. 488	 VIO SO MOVE 20180 PAG. 488	GALANTA	 GALANTA DEEP 410001 PAG. 492			

VISUAL INDEX

MAR-TORELL	 MARTORELL 20115 PAG. 494	 MARTORELL MOVE 20110 PAG. 496	 MARTORELL TARREGA 20117 PAG. 498	 MARTORELL TARREGA SO 20116 PAG. 500	 MARTORELL TARREGA SO2 20119 PAG. 500	 MARTORELL MINI CRATE 20175 PAG. 502	 MARTORELL CRATE 20176 PAG. 504
FACE	 FACE TUBULAR 20205 PAG. 506	KLIMT	 KLIMT 20134 PAG. 508	 KLIMT FIX 20135 PAG. 510			
GEO	 GEO 30511 PAG. 512	LUK	 LUK FREIR 20018 PAG. 514	 LUK FREIR 2 20019 PAG. 514	 LUK 20028 PAG. 516	 LUK 2 20071 PAG. 516	
CUBE	 CUBE 8201 PAG. 518	 CUBE SO2 8202 PAG. 518	 CUBE SO3 8203 PAG. 518	 CUBE SPOT 3120 PAG. 522	 CUBE SPOT 2 3131 PAG. 522		
 CUBE SPOT MOVE 3121 PAG. 524	 CUBE SPOT 2 MOVE 3136 PAG. 524	 CUBE SPOT SO MOVE 3134 PAG. 526	 CUBE SPOT SO 2 MOVE 3135 PAG. 526				
CAN REVIEW	 CAN REVIEW 20149 PAG. 528	ALDAIA	 ALDAIA 20157 PAG. 530	 ALDAIA SO 20120 PAG. 532			
VADI	 VADI 3177 PAG. 534	CASTEJON	 CASTEJON 20074 PAG. 536	 CASTEJON SO 20073 PAG. 536			
ROY	 ROY 20154 PAG. 538	SU	 SU 3149 PAG. 540	 SU SO 3150 PAG. 541	 SU OTIS 3234 PAG. 542		
BASIT	 BASIT 8012 PAG. 544	 BASIT MOVE 8013 PAG. 544	 BASIT MONET 20130 PAG. 546	 BASIT MONET 2 20131 PAG. 546	 BASIT LLORENS 20140 PAG. 548	 BASIT LLORENS SO 20144 PAG. 548	 BASIT DERIN 8010 PAG. 550

RECESSED WITH FRAME

KONI



CATLI

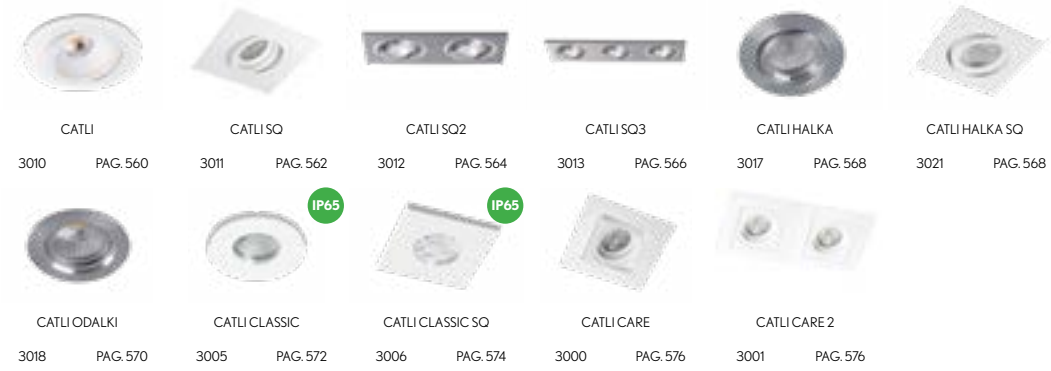



FINISHES

● COLORS



DIMENSIONS

● DIAMETERS mm.

350 | 450 | 650 | 950 | 1250

LIGHTING OPTIONS

■ DIFFUSERS

OPAL | MICROPRISMATIC

POWERS

STANDARD | HIGH

CRI

90

COLOR TEMPERATURE

2700K | 3000K | 4000K | TW

▼ DIMMABLE OPTIONS

DALI | 1.10 | PUSH

▲ LIGHT DISTRIBUTION OPTIONS

DOWN

LUMINAIRE INCLUDES

Recessed with frame mounting kit



ON DEMAND

Special RAL Color
Special Color Temperature
Number of switches
Emergency Lighting*
CRI 80
Motion Detection
RGB
Wireless Control Options (Casambi)

* Accessories are delivered separately
(not installed in luminaire).

.RF
RECESSED FRAME

INSTALLATIONS



ALABAMA

REF 10158.RF

.PN
PENDANT

·10158 ALABAMA|PN
Pag. 78

.SR
SURFACE

·10158 ALABAMA|SR
Pag. 78

.RF
RECESSED FRAME

·10158 ALABAMA|RF
Pag. 396

.TR
TRIMLESS

·10158 ALABAMA|TR
Pag. 580

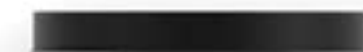
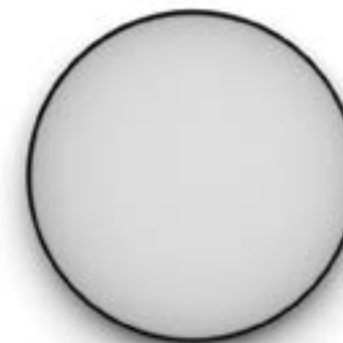

ALABAMA	REF.	DIMENSION	FINISH	DIFFUSER	POWER	CRI	K	LUMEN	WATT	mA	DIMM	SKETCH	
	10158	.35	●	.OP .MP	.ST	.9	.27	2295	18	500	.DA .PU .D1		
							.30	2385					
							.40	2475					
						.8	.27	-	35	500	.DA .PU .D1		
							.30	4590					
							.40	4956					

	10158	.45	●	.OP .MP	.ST	.9	.27	4590	35	500	.DA .PU .D1		
							.30	4770					
							.40	4950					
						.8	.27	11400 - 11820	76	700	.DA		
							.30	9180					
							.40	9912					

	10158	.65	●	.OP .MP	.ST	.9	.27	9180	71	500	.DA .PU .D1		
							.30	9540					
							.40	9900					
						.8	.27	22800-23640	152	700	.DA		
							.30	18360					
							.40	19824					

	10158	.95	●	.OP .MP	.ST	.9	.27	16830	130	500	.DA .PU .D1		
							.30	17490					
							.40	18150					
						.8	.27	41800-43340	279	700	.DA		
							.30	33660					
							.40	36344					

	10158	.125	●	.OP .MP	.ST	.9	.27	27540	212	500	.DA .PU .D1		
							.30	28620					
							.40	29700					
						.8	.27	68400-70920	457	700	.DA		
							.30	55080					
							.40	59472					

Reference order | 10158.XX.RF.XX.XX.XX.XX.XX.XX



.RF
RECESSED FRAME

ALABAMA

REF 10158.RF

- ALUMINUM PC
- 0°
- 0°
- CRI ≥90
- IK05
- IP20
- IP43
- LIFE 50000H
- DIM OPTIONAL
- INTEGRATED
- RECOIL
- 220-240 V 50-60 Hz
- CE

PHOTOMETRY

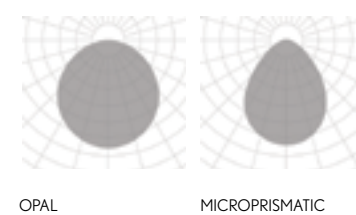

INCLUDED

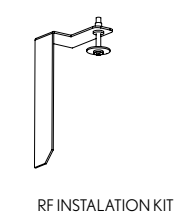

PROFILE

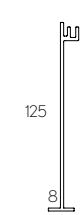

● Select external finishes

- WH-WH
- .BK-BK
- .GC-GC
- .BM-BM
- .BS-BS
- .BC-BC
- .CR-CR
- .CB-CB
- .GY-GY
- .MG-MG
- .VC-VC
- .YM-YM



FINISHES

● COLORS



DIMENSIONS

● DIAMETERS mm.

350 | 450 | 650 | 950 | 1250

LIGHTING OPTIONS

■ DIFFUSERS

OPAL | MICROPRISMATIC

POWERS

STANDARD

CRI

STANDARD

COLOR TEMPERATURE

2700K | 3000K | 4000K

▼ DIMMABLE OPTIONS

DALI | 1.10 | PUSH

▲ LIGHT DISTRIBUTION OPTIONS

DOWN

LUMINAIRE INCLUDES

Recessed with frame mounting kit



ON DEMAND

Special RAL Color
Special Color Temperature
Number of switches
Emergency Lighting*
Motion Detection
Wireless Control Options (Casambi)

* Accessories are delivered separately
(not installed in luminaire).

INSTALLATIONS



OHIO

REF 10188.RF



.PN
PENDANT

·10188 OHIO|PN
Pag. 86



.SR
SURFACE

·10188 OHIO|SR
Pag. 86



.RF
RECESSED FRAME

·10188 OHIO|RF
Pag. 400

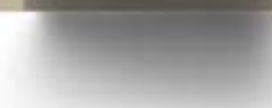

.TR
TRIMLESS

·10188 OHIO|TR
Pag. 588

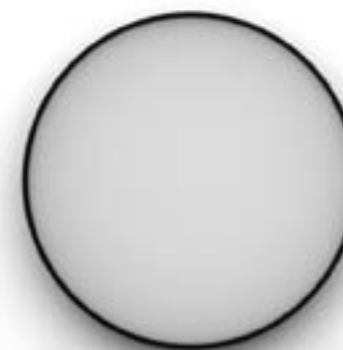

RECESSED FRAME .RF

OHIO	REF.	DIMENSION	FINISH	DIFFUSER	POWER	CRI	K	LUMEN	WATT	mA	DIMM	SKETCH
	10188	.35	●	.OP .MP	.ST	.9	.27	2706	27	700	.DA .PU .D1	
							.30	2940				
							.40	3000				
	10188	.45	●	.OP .MP	.ST	.9	.27	4510	45	700	.DA .PU .D1	
							.30	4900				
							.40	5000				
	10188	.65	●	.OP .MP	.ST	.9	.27	10824	109	700	.DA .PU .D1	
							.30	11760				
							.40	12000				
	10188	.95	●	.OP .MP	.ST	.9	.27	19844	200	700	.DA .PU .D1	
							.30	21560				
							.40	22000				
	10188	.125	●	.OP .MP	.ST	.9	.27	31570	318	700	.DA .PU .D1	
							.30	34300				
							.40	35000				

Reference order 10188.XX.RF.XX.XX.ST9.XX.XX

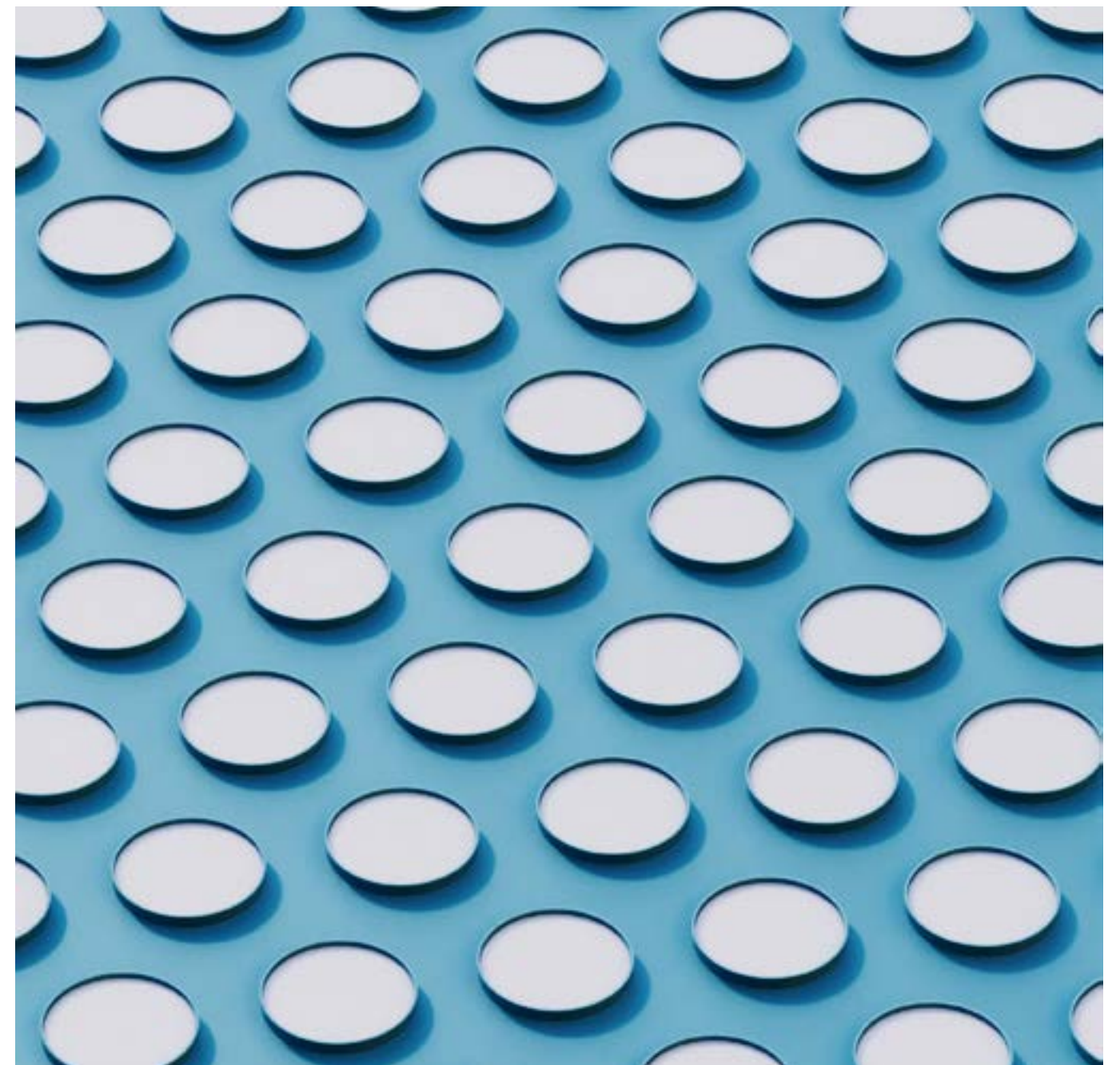

.RF
RECESSED FRAME

Select finishes



OHIO

REF 10188.RF

PHOTOMETRY

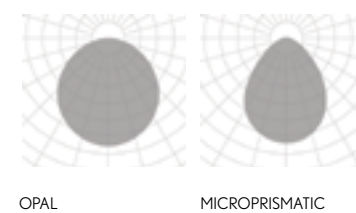

INCLUDED

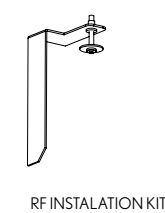

PROFILE

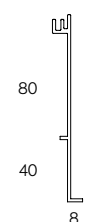



FINISHES

● COLORS



DIMENSIONS

● SIZES mm.

366x366 | 466x466 | 666x666 | 966x966 | 1266x1266

LIGHTING OPTIONS

■ DIFFUSERS

OPAL | MICROPRISMATIC

POWERS

STANDARD

CRI

90

COLOR TEMPERATURE

2700K | 3000K | 4000K

▼ DIMMABLE OPTIONS

DALI | 1.10 | PUSH

▲ LIGHT DISTRIBUTION OPTIONS

DOWN

LUMINAIRE INCLUDES

Recessed with frame mounting kit



ON DEMAND

Special RAL Color
Special Color Temperature
Number of switches
Emergency Lighting*
Motion Detection
Wireless Control Options (Casambi)

* Accessories are delivered separately (not installed in luminaire).

RECESSED FRAME

INSTALLATIONS

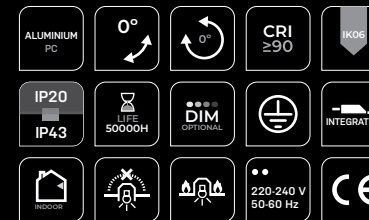

OHIO SQ

REF 10204.RF

.RF
RECESSED FRAME

10204 OHIO SQ | RF
Pag. 404

.TR
TRIMLESS

10204 OHIO SQ | TR
Pag. 592



OHIO SQ	REF.	DIMENSION	FINISH	DIFFUSER	POWER	CRI	K	LUMEN	WATT	mA	DIMM	SKETCH
	10204	.35	●	.OP .MP	.ST	.9	.27	2706	27	700	.DA .PU .D1	
							.30	2940				
							.40	3000				
	10204	.45	●	.OP .MP	.ST	.9	.27	4510	45	700	.DA .PU .D1	
							.30	4900				
							.40	5000				
	10204	.65	●	.OP .MP	.ST	.9	.27	10824	109	700	.DA .PU .D1	
							.30	11760				
							.40	12000				
	10204	.95	●	.OP .MP	.ST	.9	.27	19844	200	700	.DA .PU .D1	
							.30	21560				
							.40	22000				
	10204	.125	●	.OP .MP	.ST	.9	.27	31570	318	700	.DA .PU .D1	
							.30	34300				
							.40	35000				

Reference order | 10204.XX.RF.XX.XX.ST9.XX.XX



.RF
RECESSED FRAME

• Select finishes



OHIO
SQ

REF10204.RF

PHOTOMETRY



OPAL MICROPRISMATIC

INCLUDED

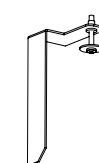

RF INSTALLATION KIT

PROFILE

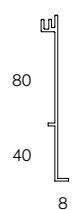



FINISHES

EXTERNAL COLOR



INTERNAL COLOR



DIMENSIONS

DIAMETERS mm.

450 | 650 | 950 | 1250

LIGHTING OPTIONS

DIFFUSERS

OPAL | MICROPRISMATIC

POWERS

STANDARD

CRI

90

COLOR TEMPERATURE

2700K | 3000K | 4000K

DIMMABLE OPTIONS

DALI | 1.10 | PUSH

LIGHT DISTRIBUTION OPTIONS

DOWN

LUMINAIRE INCLUDES

Recessed with frame mounting kit



ON DEMAND

Special RAL Color
Number of switches
Emergency Lighting*
Motion Detection
Wireless Control Options (Casambi)

* Accessories are delivered separately
(not installed in luminaire).

RECESSED FRAME

INSTALLATIONS



FLORIDA

REF 10190.RF

.PN
PENDANT

·10190 FLORIDA | PN
Pag. 90

.SR
SURFACE

·10190 FLORIDA | SR
Pag. 90

.RF
RECESSED FRAME

·10190 FLORIDA | RF
Pag. 408

.TR
TRIMLESS

·10190 FLORIDA | TR
Pag. 596

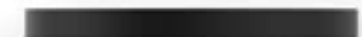

FLORIDA	REF.	DIMENSION	FINISH	DIFFUSER	POWER	CRI	K	LUMEN	WATT	mA	DIMM	SKETCH
	10190	.45	●	.OP .MP	.ST	.9	.27	4510	45	700	.DA .PU .D1	
							.30	4900				
							.40	5000				
	10190	.65	●	.OP .MP	.ST	.9	.27	10824	109	700	.DA .PU .D1	
							.30	11760				
							.40	12000				
	10190	.95	●	.OP .MP	.ST	.9	.27	19844	200	700	.DA .PU .D1	
							.30	21560				
							.40	22000				
	10190	.125	●	.OP .MP	.ST	.9	.27	31570	318	700	.DA .PU .D1	
							.30	34300				
							.40	35000				

Reference order | 10190.XX.RF.XX.XX.ST9.XX.XX



.RF
RECESSED FRAME

Select finishes

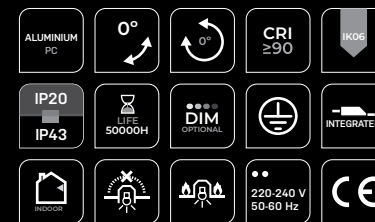

FLORIDA

REF 10190.RF

PHOTOMETRY

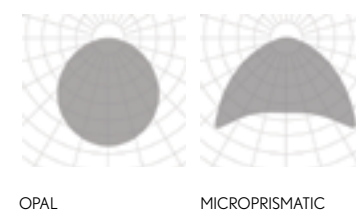

INCLUDED

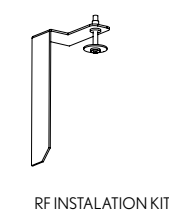

PROFILE

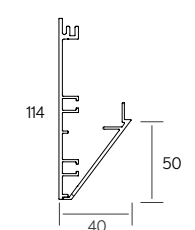



FINISHES

EXTERNAL COLOR



INTERNAL COLOR



DIMENSIONS

SIZES mm.

366x366 | 466x466 | 666x666 | 966x966 | 1266x1266

LIGHTING OPTIONS

DIFFUSERS

OPAL

MICROPRISMATIC

POWERS

STANDARD

CRI

90

COLOR TEMPERATURE

2700K | 3000K | 4000K

▼ DIMMABLE OPTIONS

DALI

1.10

PUSH

▲ LIGHT DISTRIBUTION OPTIONS

DOWN

LUMINAIRE INCLUDES

Recessed with frame mounting kit



ON DEMAND

Special RAL Color
Number of switches
Emergency Lighting*
Motion Detection
Wireless Control Options (Casambi)

* Accessories are delivered separately
(not installed in luminaire).

RECESSED FRAME

INSTALLATIONS

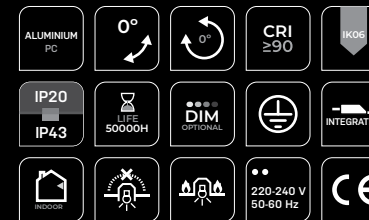

FLORIDA SQ

REF 10191.RF

.PN
PENDANT

·10191 FLORIDA SQ | PN
Pag. 94

.SR
SURFACE

·10191 FLORIDA SQ | SR
Pag. 94

.RF
RECESSED FRAME

·10191 FLORIDA SQ | RF
Pag. 412

.TR
TRIMLESS

·10191 FLORIDA SQ | TR
Pag. 600



FLORIDA SQ	REF.	DIMENSION	FINISH	DIFFUSER	POWER	CRI	K	LUMEN	WATT	mA	DIMM	SKETCH
	10191	.35	●	.OP .MP	.ST	.9	.27	2706	27	700	.DA .PU .D1	
							.30	2940				
							.40	3000				
	10191	.45	●	.OP .MP	.ST	.9	.27	5412	55	700	.DA .PU .D1	
							.30	5880				
							.40	6000				
	10191	.65	●	.OP .MP	.ST	.9	.27	10824	109	700	.DA .PU .D1	
							.30	11760				
							.40	12000				
	10191	.95	●	.OP .MP	.ST	.9	.27	21648	218	700	.DA .PU .D1	
							.30	23520				
							.40	24000				
	10191	.125	●	.OP .MP	.ST	.9	.27	36080	364	700	.DA .PU .D1	
							.30	39200				
							.40	40000				

Reference order | 10191.XX.RF.XX.XX.ST9.XX.XX



Color is an integral element of our world and has an essential role in interior design and lighting projects, that's why we upgraded our painting booth, allowing any colors. If you can dream it, we can make it.

El color es un elemento integral de nuestro mundo y tiene un papel esencial en el diseño de interiores y los proyectos de iluminación, por ello tenemos una avanzada cabina de pintura que permite cualquier opción de acabado de color. Si puedes soñarlo, nosotros podemos hacerlo.

RECESSED FRAME

Select finishes



FLORIDA SQ

REF 10191.RF

PHOTOMETRY

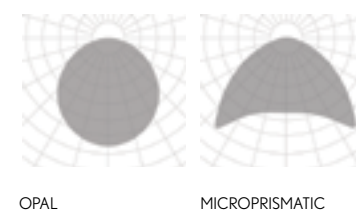

INCLUDED

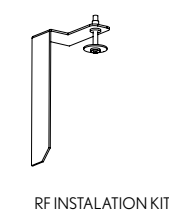

PROFILE

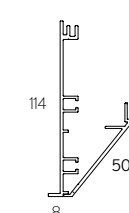



FINISHES

● COLORS



DIMENSIONS

● DIAMETERS mm.

650 | 950 | 1250 | 1500 | 2000 |
2500 | 3000 | 3500 | 4000 | 5000 | 6000 |

LIGHTING OPTIONS

■ DIFFUSERS

SILICONE

POWERS

STANDARD

CRI

90

COLOR TEMPERATURES

2700K | 3000K | 4000K

▼ DIMMABLE OPTIONS

DALI | 1.10 | PUSH

▲ LIGHT DISTRIBUTION OPTIONS

DOWN

LUMINAIRE INCLUDES



ON DEMAND

Special RAL Color
Number of switches
Emergency Lighting*
Motion Detection
Tunable White
RGB
Wireless Control Options (Casambi)

* Delivered separately
(not installed in luminaire).

.RF
RECESSED FRAME

INSTALLATIONS



ALBERTA SOFT

REF 10217.RF

.PN
PENDANT

·10217 ALBERTA SOFT | PN
Pag. 118

.SR
SURFACE

·10217 ALBERTA SOFT | SR
Pag. 118

.RF
RECESSED FRAME

·10217 ALBERTA SOFT | RF
Pag. 416



ALBERTA SOFT	REF.	DIMENSION	FINISH	DIFFUSER	POWER	CRI	K	LUMEN	WATT	mA	DIMM	SKETCH
	10217	.65	●	.SI	.HI	.9	.27	8785	86	700	.DA .PU .D1	 INT. Ø 582 EXT. Ø 654 38 Int. Ø 586 Ext. Ø 650
							.30	9040				
							.40	9687				
	10217	.95	●	.SI	.HI	.9	.27	13298	129	700	.DA .PU .D1	 INT. Ø 882 EXT. Ø 954 38 Ø INT. 886 Ø EXT. 950
							.30	13519				
							.40	14703				
	10217	.125	●	.SI	.HI	.9	.27	17816	172	700	.DA .PU .D1	 INT. Ø 1182 EXT. Ø 1254 38 Ø INT. 1186 Ø EXT. 1250
							.30	18135				
							.40	18118				
	10217	.150	●	.SI	.HI	.9	.27	-	185	500	.DA .PU .D1	 INT. Ø 1432 EXT. Ø 1504 38 Int. Ø 1436 Ext. Ø 1500
							.30	25440				
							.40	26400				
	10217	.200	●	.SI	.HI	.9	.27	-	253	500	.DA .PU .D1	 INT. Ø 1932 EXT. Ø 2004 38 Int. Ø 1936 Ext. Ø 2000
							.30	34185				
							.40	35475				
	10217	.250	●	.SI	.HI	.9	.27	-	318	500	.DA .PU .D1	 INT. Ø 2432 EXT. Ø 2504 38 Ø INT. 2436 Ø EXT. 2500
							.30	42930				
							.40	44550				

Reference order | 10217.XX.RF.XX.XX.HI.9.XX.XX

ALBERTA SOFT	REF.	DIMENSION	FINISH	DIFFUSER	POWER	CRI	K	LUMEN	WATT	mA	DIMM	SKETCH
	10217	.300	●	.SI	.HI	.9	.27	-	383	500	.DA .PU .D1	 INT. Ø 2932 EXT. Ø 3004 38 Ø INT. 2936 Ø EXT. 3000
							.30	51675				
							.40	53625				
	10217	.350	●	.SI	.HI	.9	.27	-	433	700	.DA .PU .D1	 INT. Ø 3432 EXT. Ø 3504 38 Ø INT. 3436 Ø EXT. 3500
							.30	59875				
							.40	62843				
	10217	.400	●	.SI	.HI	.9	.27	-	513	500	.DA .PU .D1	 INT. Ø 3932 EXT. Ø 4004 38 Ø INT. 3936 Ø EXT. 4000
							.30	86655				
							.40	89925				
	10217	.500	●	.SI	.HI	.9	.27	-	643	500	.DA .PU .D1	 INT. Ø 4932 EXT. Ø 5004 38 Ø INT. 4936 Ø EXT. 5000
							.30	86655				
							.40	89925				
	10217	.600	●	.SI	.HI	.9	.27	-	772	500	.DA .PU .D1	 INT. Ø 5932 EXT. Ø 6004 38 Ø INT. 5936 Ø EXT. 6000
							.30	104145				
							.40	108075				

Reference order | 10217.XX.RF.XX.XX.HI.9.XX.XX

Select finishes



ALBERTA SOFT

REF 10217.RF

PHOTOMETRY

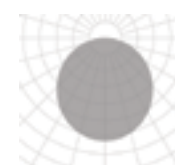

SILICONE

INCLUDED



RF INSTALLATION KIT

PROFILE

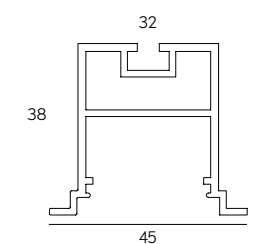

.RF

RECESSED FRAME



FINISHES

● COLORS



DIMENSIONS

● DIAMETERS mm.

650 | 950 | 1250

LIGHTING OPTIONS

■ DIFFUSERS

OPAL | MICROPRISMATIC

POWERS

STANDARD | HIGH

CRI

90

COLOR TEMPERATURE

2700K | 3000K | 4000K | TW

▼ DIMMABLE OPTIONS

DALI | 1.10 | PUSH

▲ LIGHT DISTRIBUTION OPTIONS

DOWN

LUMINAIRE INCLUDES

Recessed with frame mounting kit

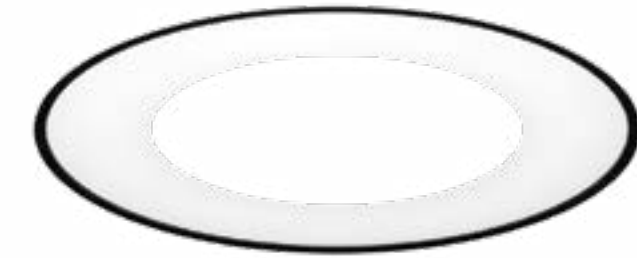

ON DEMAND

Special RAL Color
Special Color Temperature
Number of switches
Emergency Lighting*
CRI 80
Motion Detection
RGB
Wireless Control Options (Casambi)
Other Dimensions

* Accessories are delivered separately
(not installed in luminaire).

INSTALLATIONS



.PN
PENDANT

·10176 ALBERTA | PN
Pag. 132



.RF
RECESSED FRAME

·10176 ALBERTA | RF
Pag. 420



.TR
TRIMLESS

·10176 ALBERTA | TR
Pag. 604



ALBERTA

REF 10176.RF

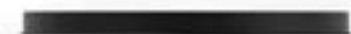
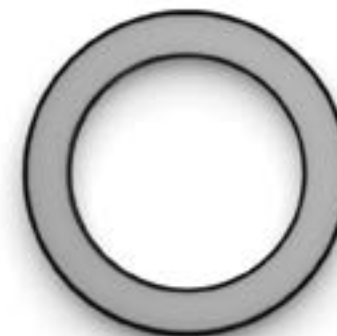

ALBERTA	REF.	DIMENSION	FINISH	DIFFUSER	POWER	CRI	K	LUMEN	WATT	mA	DIMM	SKETCH
	10176	.65	●	.OP .MP	.ST	.9	.27	3060	24	500	.DA .PU .D1	
							.30	3180				
							.40	3300				
						.8	.TW *1	9500 - 9850	64	700	.DA	
							.9	.27	-	59	500	.DA .PU .D1
								.30	6356			
.40	6608											
	10176	.95	●	.OP .MP	.ST	.9	.27	6120	47	500	.DA .PU .D1	
							.30	6360				
							.40	6600				
						.8	.TW *1	15200 - 15760	102	700	.DA	
							.9	.27	-	94	500	.DA .PU .D1
								.30	12712			
.40	13216											
	10176	.125	●	.OP .MP	.ST	.9	.27	9180	71	500	.DA .PU .D1	
							.30	9540				
							.40	9900				
						.8	.TW *1	22800-23640	152	700	.DA	
							.9	.27	-	142	500	.DA .PU .D1
								.30	19068			
.40	19824											

Reference order 10176.XX.RF.XX.XX.XX.XX.XX



Perfection has a circular shape
La Perfección tiene forma circular

• Select finishes



.WH-WH .BK-BK .GC-GC .BM-BM .BS-BS .BC-BC .CR-CR .CB-CB .GY-GY .MG-MG .VC-VC .YM-YM



ALBERTA

REF 10176.RF

PHOTOMETRY

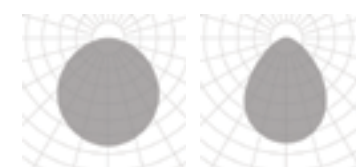

OPAL MICROPRISMATIC

INCLUDED

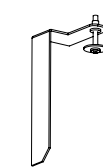

RF INSTALLATION KIT

PROFILE

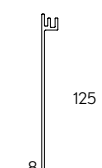

125
8

*1 Tunable White (TW) values correspond to 2700K and 6500K - TW is only available for DALI DT8 dimmable (DA), CRI 80 (8) 700mA. Los valores del blanco dinámico (TW) corresponden a 2700K y 6500K. -TW solo está disponible con protocolo DALI DT8 (DA), CRI 80 (8) 700mA.

A blank canvas.

There are no limits Don't worry about lighting. Imagine the end result and use our Line profiles to make it happen. Few collections can be combined in so many ways to create so many looks and fulfil so many functions. It's the joker in the pack for designing unique spaces..

When it comes to technology, there's no shortage of features: With options for indirect light, dimmer, tunable white, RedUGeR®, customizable technology... and more.

Un lienzo en blanco.

Vía libre. No pensar en las luminarias. Pensar en el resultado final, y nuestra perfilería lineal se adaptará a ello. Pocas colecciones se prestan a tantas combinaciones, tanto estéticas como de funcionamiento, por ello es un comodín a la hora de diseñar espacios que requieren de un plus de singularidad.

A nivel técnico, un auténtico compendio de ventajas: Capacidad de incorporar luz indirecta, regulaciones, blanco dinámico, RedUGeR®, personalizable en aspectos técnicos... entre otros muchos beneficios.



LINES

RECESSED WITH FRAME



Mastering light has never been so easy

Alarik is a set of modular designs for building or simplifying your lighting scheme. With Mini and Slim versions - and their own subfamilies - they adapt to every need.

It's playtime! Lighting design with Alarik is an exercise in creativity. Freedom, functionality, uniqueness... In short, unbridled flexibility and total control over the final result.

Jugar con luz nunca ha sido tan fácil

Alarik combina referencias modulares que permiten crecer o simplificar los puntos de luz, así como versiones Mini y Slim - a la vez con sus propias subfamilias - que se adaptan a cada necesidad.

¡Que empiece el juego! Iluminar con Alarik es lo más parecido a un ejercicio de ingenio. Libertad, funcionalidad, singularidad... en definitiva, diseño sin ataduras y siempre con el control absoluto del resultado a obtener.

ALARIK SLIM



FINISHES

● COLORS



DIMENSIONS

● LENGTHS

PER METER

COMPONENTS

SLIM PATRICIA
SLIM PATRICIA ZOOM
SLIM LED BALL
SLIM TUBE
SLIM WALL WASHER
SLIM LENSES
SLIM MOTION LENSES
SLIM LED MODULES

POWER

STANDARD

CRI

90

COLOR TEMPERATURE

2700K | 3000K | 4000K

▼ DIMMABLE OPTIONS

DALI | 1.10

▲ LIGHT DISTRIBUTION

DOWN

LUMINAIRE INCLUDES

Recessed with frame mounting kit



ON DEMAND
Profile Special RAL Color
Taylor your own design

RECESSED FRAME

INSTALLATIONS



.PN
PENDANT

·20224 ALARIK SLIM |PN
Pag. 178

.SR
SURFACE

·20224 ALARIK SLIM |SR
Pag. 178

.RF
RECESSED FRAME

·20224 ALARIK SLIM |RF
Pag. 428

.TR
TRIMLESS

·20224 ALARIK SLIM |TR
Pag. 622

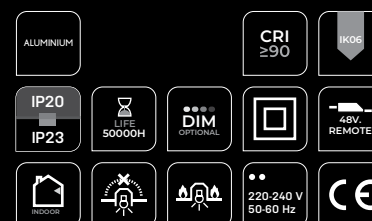

ALARIK SLIM

REF 20224.RF

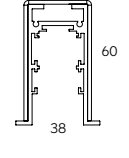

ALARIK SLIM	REF.	DIMENSION	FINISH	SKETCH
	20224	.01 1 mt.	●	



Reference order 20224.XX.RF.XX

48V TRANSFORMER	DIMENSION	WATT
DR48	.01	75
	.02	120
	.03	200

Reference order DR48.XX

INTEGRATED POWER	REF.	WATT
	10246.DR (404x43x22mm)	200W

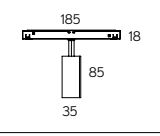
Reference order 10246.DR

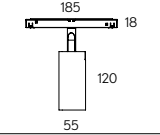
SLIM PATRICIA *1	REF.	DIMENSION	FINISH	OPTIC OPTIONS	POWER	CRI	K	LUMEN	WATT	VdC	DIMM	SKETCH
	11544	.01	●	.15 .38 .60	.ST	.9	.27	525	8	48	.DA .D1	
							.30	565				
							.40	660				
	11544	.02	●	.15 .38 .60	.ST	.9	.27	1070	15	48	.DA .D1	
							.30	1147				
							.40	1267				

Reference order 11544.XX.XX.XX.ST9.XX.XX

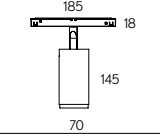
SLIM PATRICIA ZOOM *1	REF.	DIMENSION	FINISH	OPTIC OPTIONS	POWER	CRI	K	LUMEN	WATT	VdC	DIMM	SKETCH
	11546	.01	●	.15-36 .36-60	.ST	.9	.27	1888	25	48	.DA .D1	
							.30	1995				
							.40	2191				

Reference order 11546.01.XX.XX.ST9.XX.XX

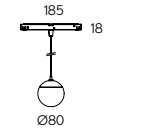
SLIM LED BALL *1	REF.	DIMENSION	FINISH	OPTIC OPTIONS	POWER	CRI	K	LUMEN	WATT	VdC	DIMM	SKETCH
	11551	.01	●	.37	.ST	.9	.27	355	8	48	.DA .D1	
							.30	383				
							.40	396				

Reference order 11551.01.XX.XX.ST9.XX.XX

*1 LED Modules are Class III.
Los módulos LED son Clase III.

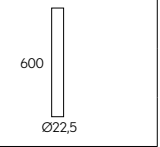
SLIM LED TUBE 20 *1	REF.	DIMENSION	FINISH	OPTIC OPTIONS	POWER	CRI	K	LUMEN	WATT	VdC	DIMM	SKETCH
	11553	.01	●	.20 .40	.ST	.9	.27	174	3	48	.DA .D1	
							.30	187				
							.40	212				

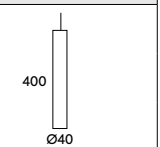

Reference order 11553.01.XX.XX.ST9.XX.XX

SLIM LED TUBE 40 *1	REF.	DIMENSION	FINISH	OPTIC OPTIONS	POWER	CRI	K	LUMEN	WATT	VdC	DIMM	SKETCH
	11552	.01	●	.20 .40	.ST	.9	.27	954	14	48	.DA .D1	
							.30	991				
							.40	1067				

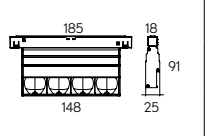
Reference order 11552.01.XX.XX.ST9.XX.XX

SLIM WALL WASHER *1	REF.	DIMENSION	FINISH	OPTIC OPTIONS	POWER	CRI	K	LUMEN	WATT	VdC	DIMM	SKETCH
	11550	.01	.BK-BK	-	.ST	.9	.27	882	15	48	.DA .D1	
							.30	1013				
							.40	1107				

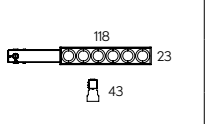
Reference order 11550.01.BK-BK.XX.ST9.XX.XX

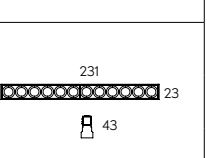
SLIM LENSES *1	REF.	DIMENSION	FINISH	OPTIC OPTIONS	POWER	CRI	K	LUMEN	WATT	VdC	DIMM	SKETCH
	11548	.01	.BK-BK	.15 .38	.ST	.9	.27	725	8	48	.DA .D1	
							.30	750				
							.40	827				
	11548	.02	.BK-BK	.15 .38	.ST	.9	.27	1320	15	48	.DA .D1	
							.30	1511				
							.40	1654				

Reference order 11548.XX.BK-BK.XX.ST9.XX.XX

● Select finish

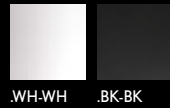

ALARIK SLIM

REF 20224.RF

PHOTOMETRY

SLIM PATRICIA | SLIM PATRICIA ZOOM

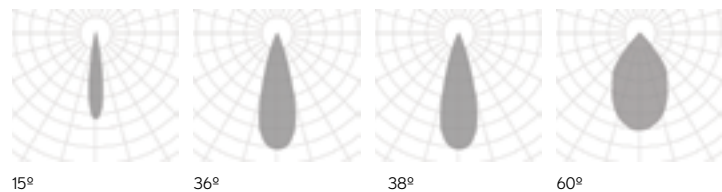

PHOTOMETRY

SLIM LED BALL | SLIM WALL WASHER



PHOTOMETRY

SLIM TUBE

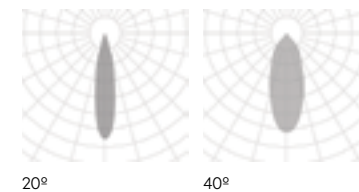

PHOTOMETRY

SLIM LENSES

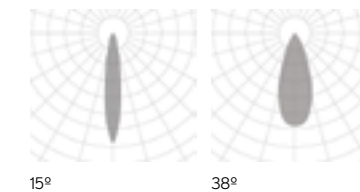

RECESSED FRAME

.RF

SLIM MOTION LENSES *1	REF.	DIMENSION	FINISH	OPTIC OPTIONS	POWER	CRI	K	LUMEN	WATT	VdC	DIMM	SKETCH
	11547	.01	.BK-BK	.15 .38	.ST	.9	.27	660	8	48	.DA .D1	
							.30	750				
							.40	827				

Reference order | 11547.01.BK-BK.XX.ST9.XX.XX

SLIM LED MODULES *1	REF.	DIMENSION	FINISH	DIFFUSER	POWER	CRI	K	LUMEN	WATT	VdC	DIMM	SKETCH
	11549	.01	.BK-BK	.OP	.ST	.9	.27	558	9	48	.DA .D1	
							.30	560				
							.40	604				
	11549	.02	.BK-BK	.OP	.ST	.9	.27	1115	18	48	.DA .D1	
							.30	1120				
							.40	1208				
	11549	.03	.BK-BK	.OP	.ST	.9	.27	1670	24	48	.DA .D1	
							.30	1680				
							.40	1812				

Reference order | 11549.XX.BK-BK.XX.ST9.XX.XX

*1 LED Modules are Class III.
Los módulos LED son Clase III.

Total length = Profile length + 2x8mm (Cover kit)
 (Total length - 8mm) x 30mm
 90mm

COMPONENTS

COVER KIT	REF.	FINISH
	TF19 2x8mm.	<input checked="" type="radio"/>

Reference order | TF19.RF.XX

JOINTS & CONNECTORS

LINEAR JOINT	FINISH
	<input checked="" type="radio"/>
	.BK-BK .WH-WH

UR19.XX

ANGLE JOINT	FINISH
	<input checked="" type="radio"/>
	.BK-BK .WH-WH

UL19.XX

WALL-CEILING JOINT	FINISH
	<input checked="" type="radio"/>
	.BK-BK .WH-WH

UV19.XX

POWER FEEDER UNIT	FINISH
	<input checked="" type="radio"/>
	.BK-BK .WH-WH

ACC20224.CA.XX

Select finish

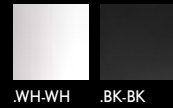

- ALUMINIUM
- IP20
- IP23
- LIFE 50000H
- DIM OPTIONAL
- 48V. REMOTE
- RECOOL
- 220-240 V 50-60 Hz
- CE
- CRI ≥90
- IK05

ALARIK SLIM

REF 20224.RF

PHOTOMETRY

SLIM MOTION LENSES

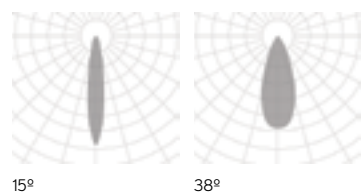

PHOTOMETRY



OPAL

INCLUDED

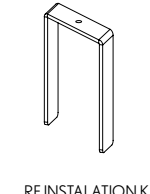

RF INSTALLATION KIT

PROFILE

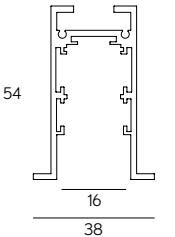

RECESSED FRAME

.RF



FINISHES

● COLORS



DIMENSIONS

● LENGTHS

PER METER

COMPONENTS

LED MODULES
LENSES
MINI TUBE
MINI TUBE STICK

POWER

STANDARD

CRI

90

COLOR TEMPERATURE

2700K | 3000K | 4000K

▼ DIMMABLE OPTIONS

DALI | 1.10 | PUSH

▲ LIGHT DISTRIBUTION

DOWN

LUMINAIRE INCLUDES

Recessed with frame mounting kit



ON DEMAND

Special RAL Color
Special Shapes
Emergency Lighting*
Motion Detection
Taylor your own design
Special RAL Color
Tunable White

* Delivered separately
(not installed in luminaire).

RECESSED FRAME

INSTALLATIONS



MODULIGHT

REF 10210.RF



.PN
PENDANT

·10210 MODULIGHT | PN
Pag. 196



.SR
SURFACE

·10210 MODULIGHT | SR
Pag. 196



.RF
RECESSED FRAME

·10210 MODULIGHT | RF
Pag. 434



.TR
TRIMLESS

·10210 MODULIGHT | TR
Pag. 634

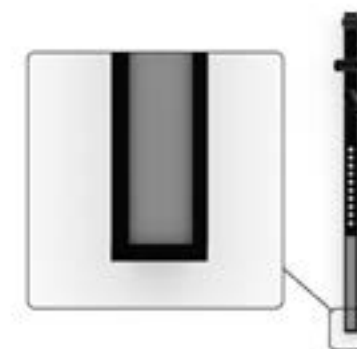

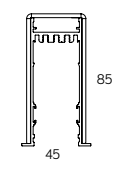
MODULIGHT	REF.	DIMENSION	FINISH	SKETCH
	10210	.01 1m	●	

Reference order | 10210.XX.RF.XX

DRIVER	DIMENSION*1	DIMM
DR10210	.01 0 - 15 W	.DA .PU .D1
	.02 16 - 30 W	
	.03 31 - 65 W	
	.04 66 - 90 W	

Reference order | DR10210.XX.XX

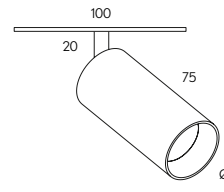
MINI TUBE	REF.	DIMENSION	FINISH	OPTIC OPTIONS	POWER	CRI	K	LUMEN	WATT	mA	SKETCH
 90° 350°	11526	.01	.BK-BK .WH-WH	.15 .24 .38	.ST	.9	.27	432	8	700	
							.30	445			
							.40	492			

Reference order | 11526.01.XX.XX.ST9.XX

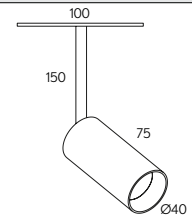
MINI TUBE STICK	REF.	DIMENSION	FINISH	OPTIC OPTIONS	POWER	CRI	K	LUMEN	WATT	mA	SKETCH
 90° 350°	11538	.01	.BK-BK .WH-WH	.15 .24 .38	.ST	.9	.27	432	8	700	
							.30	445			
							.40	492			





Reference order | 11538.01.XX.XX.ST9.XX

 Modular system that requires a technical drawing

*1 Driver power must be at least 15% higher than the sum of the power of selected LED modules. *La potencia del driver deber ser por lo menos un 15% mayor que la suma de la potencia de los modulos LED elegidos.*

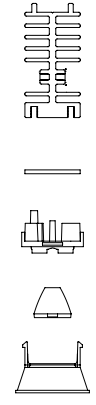
• Select lens finishes



LENSES	REF.	DIMENSIONS	SHAPE	FINISH	OPTIC OPTIONS	POWER	CRI	K	LUMEN	WATT	mA	SKETCH
	11525	.01 29mm.	.RD .SQ	●	.20 .40 .60	.ST	.9	.27	161	2	700	
								.30	169			
								.40	176			
	11525	.03 80mm.	.RD .SQ	●	.20 .40 .60	.ST	.9	.27	483	6	700	
								.30	507			
								.40	528			
	11525	.05 133mm.	.RD .SQ	●	.20 .40 .60	.ST	.9	.27	805	10	700	
								.30	845			
								.40	880			
	11525	.10 263mm.	.RD .SQ	●	.20 .40 .60	.ST	.9	.27	1603	20	700	
								.30	1690			
								.40	1760			

Reference order | 11525.XX.XX.XX.XX.ST9.XX

COVER	REF.	FINISH
	ACC10210.01	●

Reference order | ACC10210.01.XX

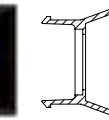
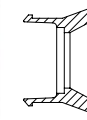

.RF
RECESSED FRAME

MODULIGHT

REF 10210.RF

PHOTOMETRY

MINI TUBE

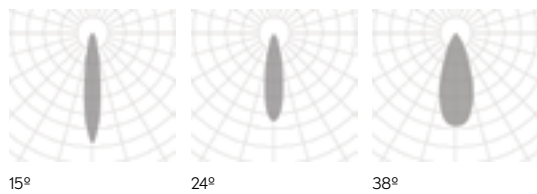

PHOTOMETRY

LENSES



LED MODULES	REF.	DIMENSION ▲	DIFFUSER ■	POWER	CRI	K	LUMEN	WATT	mA	SKETCH
	11524	.01 281mm.	.OP .MP	.HI	.9	.27	1120	12	700	
						.30	1173			
						.40	1125			
	11524	.02 562mm.	.OP .MP	.HI	.9	.27	2240	24	700	
						.30	2346			
						.40	3375			
	11524	.03 843mm.	.OP .MP	.HI	.9	.27	3360	36	700	
						.30	3519			
						.40	3375			
	11524	.04 1124mm.	.OP .MP	.HI	.9	.27	4480	48	700	
						.30	4692			
						.40	4500			
	11524	.05 1405mm.	.OP .MP	.HI	.9	.27	5600	60	700	
						.30	5865			
						.40	5625			
	11524	.06 1686mm.	.OP .MP	.HI	.9	.27	6720	72	700	
						.30	7038			
						.40	6750			

Reference order | **11524.XX.XX.HI.9.XX**

COMPONENTS

COVER KIT	REF.	FINISH
	TF23 2x8mm.	●

Reference order | **TF23.RF.XX**

JOINTS

LINEAR JOINT	ANGLE JOINT *2	T-JOINT	CROSS JOINT	WALL-CEILING JOINT	FINISH
		X	X		●
UR23	UL23	X	X	UV23	

Reference order | **XX23.RF.XX**

*2 Miter cut diffuser. Difusor a inglete.

• Select finish

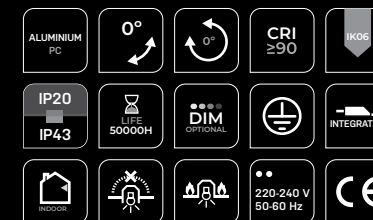

MODULIGHT

REF 10210.RF

PHOTOMETRY

LED MODULES

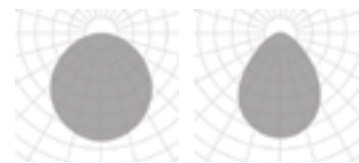

OPAL

MICROPRISMATIC

INCLUDED



RF INSTALLATION KIT

PROFILE

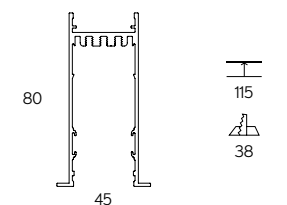

.RF

RECESSED FRAME

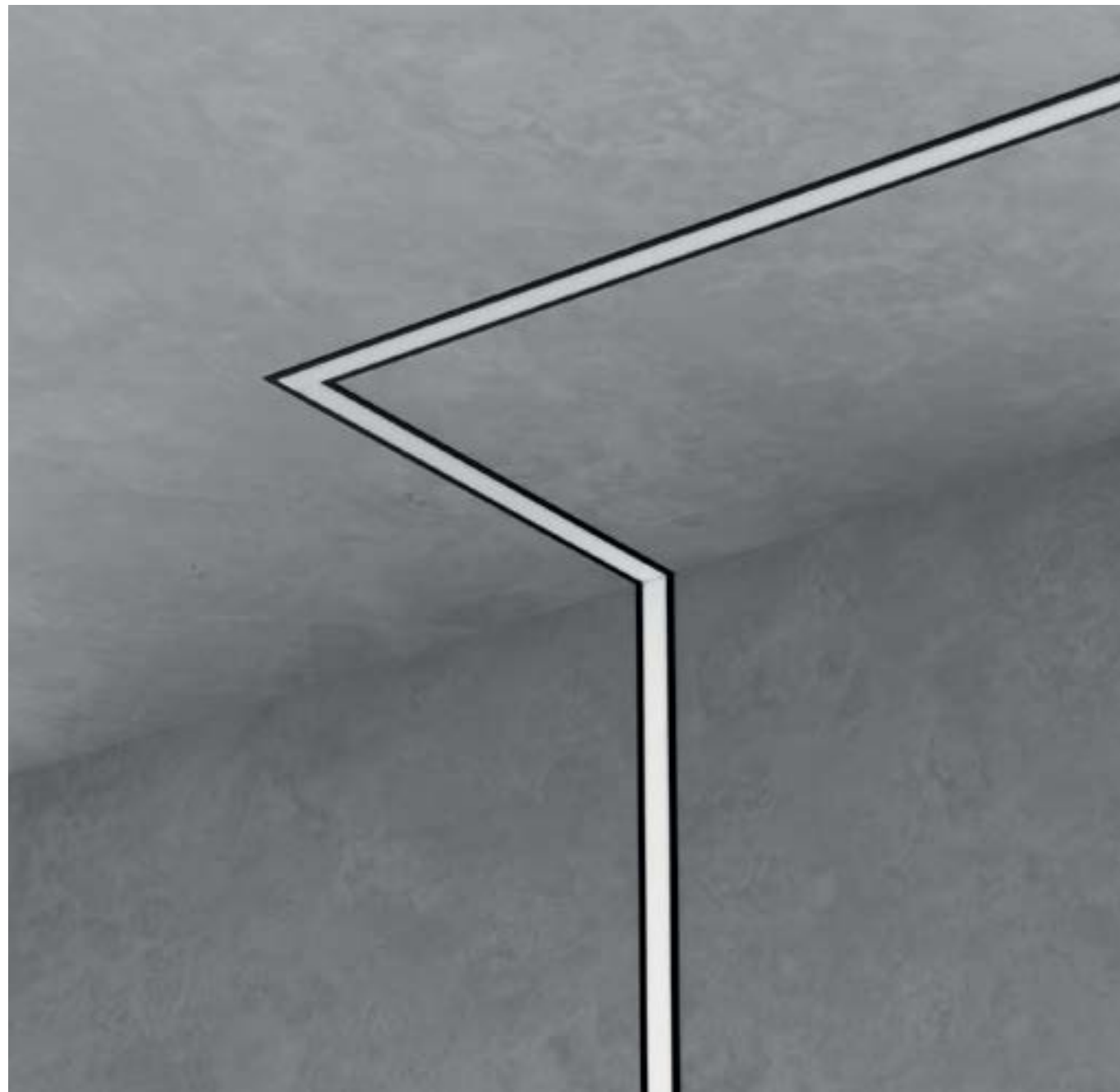

FINISHES

● COLORS



DIMENSIONS

◆ ELECTRIC SYSTEM LENGTH mm.

843 | 1124 | 1405 | 1686 | 1967 | 2248

LIGHTING OPTIONS

■ DIFFUSERS

OPAL | MICROPRISMATIC

POWER

STANDARD | HIGH

CRI

90

COLOR TEMPERATURE

2700K | 3000K | 4000K | TW

▼ DIMMABLE OPTIONS

DALI | 1.10 | PUSH

▲ LIGHT DISTRIBUTION

DOWN

LUMINAIRE INCLUDES

Recessed with frame mounting kit

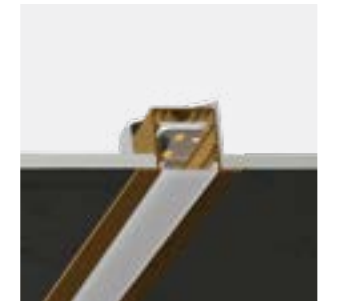
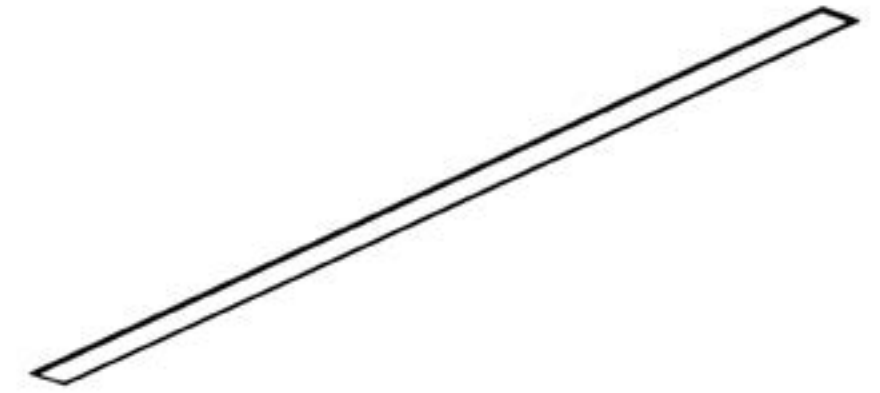

ON DEMAND

Special RAL Color
Emergency Lighting*
Motion Detection
Well-Certified LED Boards
Taylor your own design
Special Color Temperature
RGB
Thematic LED
Wireless Control Options (Casambi)
CRI 80

* Delivered separately
(not installed in luminaire).

RECESSED FRAME

INSTALLATIONS

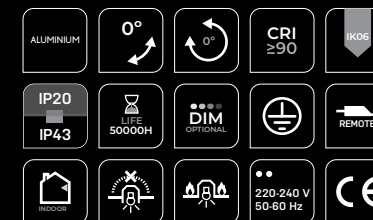

ALBA MINI

REF 10211.RF

.PN
PENDANT

-10211 ALBA MINI | PN
Pag. 226

.SR
SURFACE

-10211 ALBA MINI | SR
Pag. 226

.RF
RECESSED FRAME

-10211 ALBA MINI | RF
Pag. 440

.TR
TRIMLESS

-10211 ALBA MINI | TR
Pag. 640

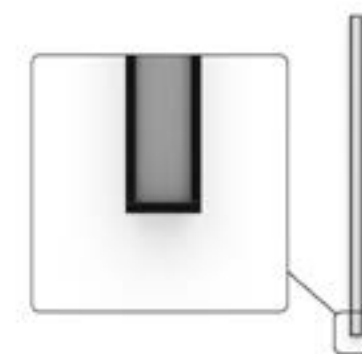

REF.	ELECTRIC SYSTEM LENGTH		FINISH	DIFFUSER	POWER	CRI	DOWNLIGHT *2 LUMEN				WATT		DIMM
	MM	MM					.27	.30	.40	.TW *1	K	TW	
10211	.03	843	●	.OP .MP	.ST	.9	2295	2385	2475	5700-5910	18	38	.DA .PU .D1
	.04	1124					3060	3180	3300	7600-7880	24	51	
	.05	1405					3825	3975	4125	9500-9850	30	64	
	.06	1686					4590	4770	4950	11400-11820	36	76	
	.07	1967					5355	5565	5775	13300-13790	42	89	
	.08	2248					6120	6360	6600	15200-15760	48	102	

REF.	ELECTRIC SYSTEM LENGTH		FINISH	DIFFUSER	POWER	CRI	DOWNLIGHT *2 LUMEN			WATT	DIMM
	MM	MM					.27	.30	.40		
10211	.03	843	●	.OP .MP	.HI	.9	4590	4767	4956	36	.DA .PU .D1
	.04	1124					6120	6356	6608	48	
	.05	1405					7650	7945	8260	60	
	.06	1686					9180	9534	9912	72	
	.07	1967					10710	11123	11564	84	
	.08	2248					12240	12712	13216	96	

Reference order | 10211.XX.RF.XX.XX.XX.9.XX.XX

Total length = Electric System Length + 25mm + 2x8mm (Cover kit)

Linear Joint Total length = Profile length + 25mm + [2 x 8mm (Cover kit)] + [N° of URO3 x 8]

Joints, other than Linear joint, require a technical drawing

(Total length - 8mm) x 38mm

70mm

Select finish



COMPONENTS

COVER KIT	REF.	FINISH
	TF03	●
	2x8mm.	

Reference order | TF03.RF.XX

JOINTS

LINEAR JOINT	ANGLE JOINT*3	T-JOINT	CROSS JOINT	WALL-CEILING JOINT	FINISH
					●
URO3	UL03	UT03	UC03	UV03	

Reference order | XX03.RF.XX

ALBA MINI

REF 10211.RF

PHOTOMETRY

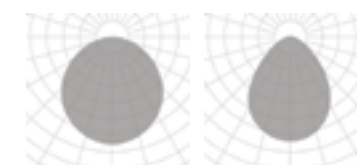

OPAL

MICROPRISMATIC

INCLUDED

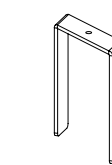

RF INSTALLATION KIT

PROFILE

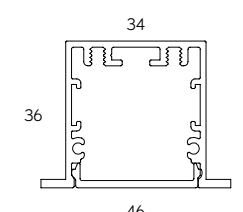

46

*1 Tunable White (TW) values correspond to 2700K and 6500K - TW is only available for DALI DT8 dimmable (DA), CRI 80 (8) 700mA. Los valores del blanco dinámico (TW) corresponden a 2700K y 6500K. -TW solo está disponible con protocolo DALI DT8 (DA), CRI 80 (8) 700mA.

*2 Down light (direct light) works at 500mA. La luz directa trabaja a 500mA.

*3 Miter cut diffuser. Difusor a inglete.



FINISHES

● COLORS



DIMENSIONS

◆ ELECTRIC SYSTEM LENGTH mm.

843 | 1124 | 1405 | 1686 | 1967 | 2248

LIGHTING OPTIONS

■ DIFFUSERS

OPAL | MICROPRISMATIC

POWER

STANDARD | HIGH

CRI

90

COLOR TEMPERATURE

2700K | 3000K | 4000K | TW

▼ DIMMABLE OPTIONS

DALI | 1.10 | PUSH

▲ LIGHT DISTRIBUTION

DOWN

LUMINAIRE INCLUDES

Recessed with frame mounting kit

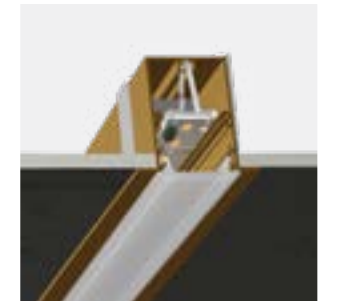
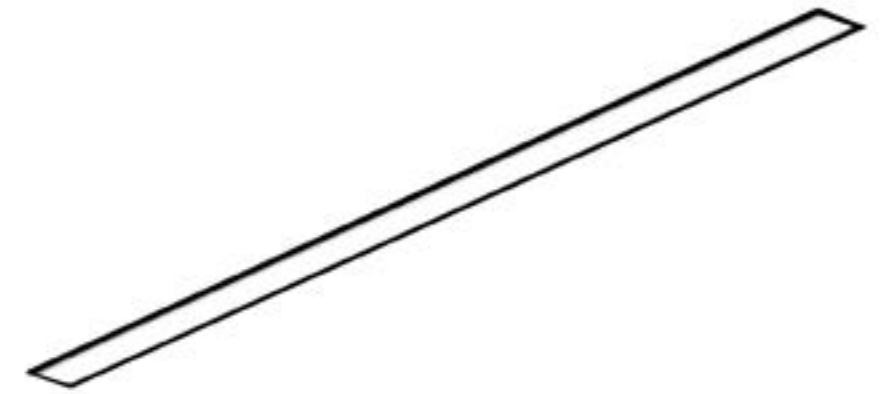

ON DEMAND

Special RAL Color
Emergency Lighting*
Motion Detection
Well-Certified LED Boards
Taylor your own design
Special Color Temperature
RGB
Thematic LED
Wireless Control Options (Casambi)
CRI 80

* Delivered separately
(not installed in luminaire).

RECESSED FRAME .RF

INSTALLATIONS



ALBA

REF 10160.RF

.PN
PENDANT

·10160 ALBA | PN
Pag. 230

.WS
WALL SURFACE

·10160 ALBA | WS
Pag. 786

.TK
TRACK

·10160 ALBA | TK
Pag. 760

.SR
SURFACE

·10160 ALBA | SR
Pag. 230

.RF
RECESSED FRAME

·10160 ALBA | RF
Pag. 444

.TR
TRIMLESS

·10160 ALBA | TR
Pag. 644

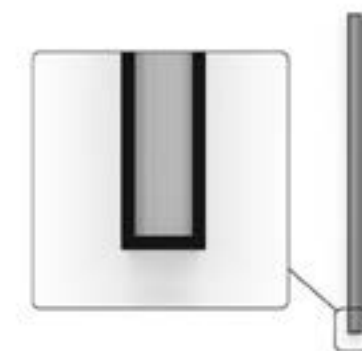

REF.	ELECTRIC SYSTEM LENGTH		FINISH	DIFFUSER	POWER	CRI	DOWNLIGHT *2 LUMEN				WATT		DIMM
	MM	MM					.27	.30	.40	.TW *1	K	TW	
10160	.03	843	●	.OP .MP	.ST	.9	2295	2385	2475	5700-5910	18	38	.DA .PU .D1
	.04	1124					3060	3180	3300	7600-7880	24	51	
	.05	1405					3825	3975	4125	9500-9850	30	64	
	.06	1686					4590	4770	4950	11400-11820	36	76	
	.07	1967					5355	5565	5775	13300-13790	42	89	
	.08	2248					6120	6360	6600	15200-15760	48	102	

REF.	ELECTRIC SYSTEM LENGTH		FINISH	DIFFUSER	POWER	CRI	DOWNLIGHT *2 LUMEN			WATT	DIMM
	MM	MM					.27	.30	.40		
10160	.03	843	●	.OP .MP	.HI	.9	4590	4767	4956	36	.DA .PU .D1
	.04	1124					6120	6356	6608	48	
	.05	1405					7650	7945	8260	60	
	.06	1686					9180	9534	9912	72	
	.07	1967					10710	11123	11564	84	
	.08	2248					12240	12712	13216	96	

Reference order | 10160.XX.RF.XX.XX.XX9.XX.XX

Total length = Electric System Length + 10mm + 2x8mm (Cover kit)
 (Total length - 8mm) x 51mm
 100mm

● Select finish



COMPONENTS

COVER KIT	REF.	FINISH
	TF02 2x8mm.	●

Reference order | TF02.RF.XX

REDUGER	REF.	POWER
	ACC.RG	.ST .HI

Reference order | ACC.RG.XX

JOINTS

LINEAR JOINT	ANGLE JOINT*3	T-JOINT	CROSS JOINT	WALL-CEILING JOINT	FINISH
					●
UR02	UL02	UT02	UX02	UV02	

Joints, other than Linear joint, require a technical drawing

Reference order | XX02.RF.XX

ALBA

REF 10160.RF

PHOTOMETRY

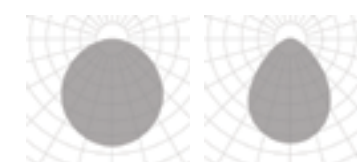

OPAL MICROPRISMATIC

INCLUDED

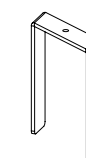

RF INSTALLATION KIT

PROFILE

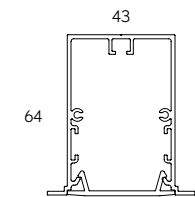

59

*1 Tunable White (TW) values correspond to 2700K and 6500K - TW is only available for DALI DT8 dimmable (DA), CRI 80 (8) 700mA. Los valores del blanco dinámico (TW) corresponden a 2700K y 6500K. -TW solo está disponible con protocolo DALI DT8 (DA), CRI 80 (8) 700mA.

*2 Down light (direct light) works at 500mA. La luz directa trabaja a 500mA.

*3 Miter cut diffuser. Difusor a inglete.

new



FINISHES

● EXTERNAL COLOR



INTERNAL COLOR



● ELECTRIC SYSTEM LENGTH mm.

843 | 1124 | 1405 | 1686 | 1967 | 2248

LIGHTING OPTIONS

■ DIFFUSERS

TRANSPARENT

POWER

STANDARD | HIGH

CRI

90

COLOR TEMPERATURE

2700K | 3000K | 4000K | TW

▼ DIMMABLE OPTIONS

DALI | 1.10 | PUSH

▲ LIGHT DISTRIBUTION

ASYMETRIC DOWN

LUMINAIRE INCLUDES

Recessed with frame mounting kit

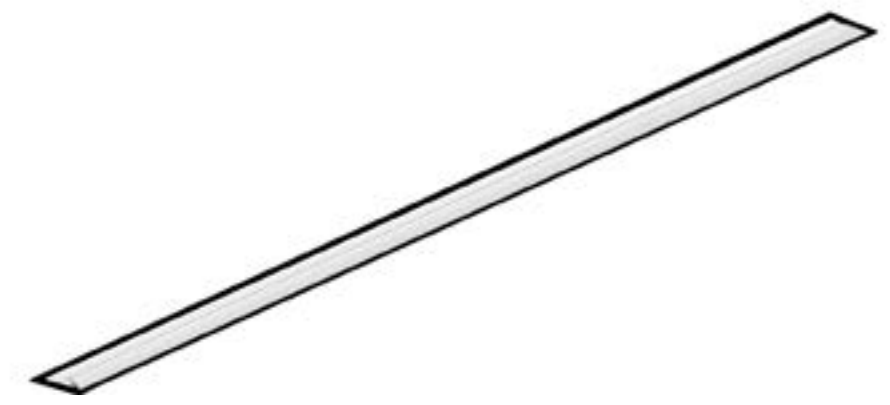

ON DEMAND

Special RAL Color
Emergency Lighting*
Well-Certified LED Boards
Special Color Temperature
RGB
Thematic LED
Wireless Control Options (Casambi)
CRI 80

* Delivered separately
(not installed in luminaire).

.RF
RECESSED FRAME

INSTALLATIONS



ALBA ASIMETRIC

REF 210009.RF



.PN
PENDANT

·210009 ALBA ASIMETRIC
| PN - Pag. 242



.WS
WALL SURFACE

·210009 ALBA ASIMETRIC
| WS - Pag. 794



.SR
SURFACE

·210009 ALBA ASIMETRIC
| SR - Pag. 242



.RF
RECESSED FRAME

·210009 ALBA ASIMETRIC
| RF - Pag. 448



.TR
TRIMLESS

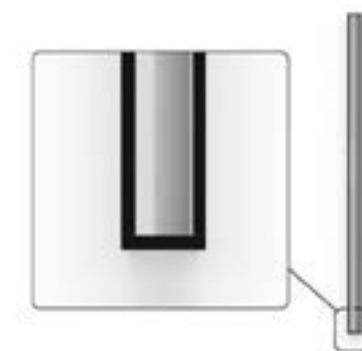

·210009 ALBA ASIMETRIC
| TR - Pag. 648



REF.	ELECTRIC SYSTEM LENGTH		FINISH	DIFFUSER	POWER	CRI	DOWNLIGHT *2 LUMEN				WATT		DIMM
	MM	MM					.27	.30	.40	.TW *1	K	TW	
210009	.03	843	●	.TP	.ST	.9	2295	2385	2475	5700-5910	18	38	.DA .PU .D1
	.04	1124					3060	3180	3300	7600-7880	24	51	
	.05	1405					3825	3975	4125	9500-9850	30	64	
	.06	1686					4590	4770	4950	11400-11820	36	76	
	.07	1967					5355	5565	5775	13300-13790	42	89	
	.08	2248					6120	6360	6600	15200-15760	48	102	

REF.	ELECTRIC SYSTEM LENGTH		FINISH	DIFFUSER	POWER	CRI	DOWNLIGHT *2 LUMEN			WATT		DIMM
	MM	MM					.27	.30	.40	K	TW	
210009	.03	843	●	.TP	.HI	.9	4590	4767	4956	36		.DA .PU .D1
	.04	1124					6120	6356	6608	48		
	.05	1405					7650	7945	8260	60		
	.06	1686					9180	9534	9912	72		
	.07	1967					10710	11123	11564	84		
	.08	2248					12240	12712	13216	96		

Reference order | 210009.XX.RF.XX.XX.XX.XX.XX.XX

 Total length = Electric System Length + 10mm + 2x8mm (Cover kit)
 (Total length - 8mm) x 51mm
 100mm

● Select finish



COMPONENTS

COVER KIT	REF.	FINISH
	TF06 2x8mm.	●

Reference order | TF06.RF.XX

JOINTS

LINEAR JOINT

UR06



RECESSED FRAME

ALBA ASIMETRIC

REF 210009.RF

PHOTOMETRY



TRANSPARENT PC

INCLUDED



RF INSTALLATION KIT

PROFILE

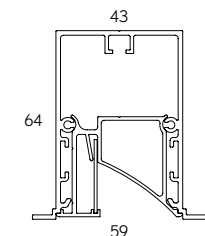

*1 Tunable White (TW) values correspond to 2700K and 6500K - TW is only available for DALI DT8 dimmable (.DA), CRI 80 (8) 700mA. Los valores del blanco dinámico (TW) corresponden a 2700K y 6500K. -TW solo está disponible con protocolo DALI DT8 (.DA), CRI 80 (8) 700mA.
 *2 Down light (direct light) works at 500mA. La luz directa trabaja a 500mA.



FINISHES

● COLORS



DIMENSIONS

◆ ELECTRIC SYSTEM LENGTH mm.

843 | 1124 | 1405 | 1686 | 1967 | 2248

LIGHTING OPTIONS

■ DIFFUSERS

OPAL | MICROPRISMATIC

POWER

STANDARD | HIGH

CRI

90

COLOR TEMPERATURE

2700K | 3000K | 4000K | TW

▼ DIMMABLE OPTIONS

DALI | 1.10 | PUSH

▲ LIGHT DISTRIBUTION

DOWN

LUMINAIRE INCLUDES

Recessed with frame mounting kit

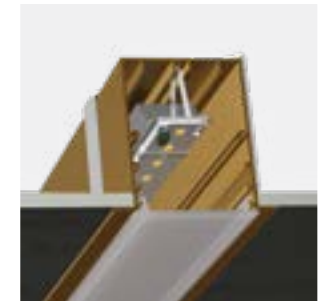
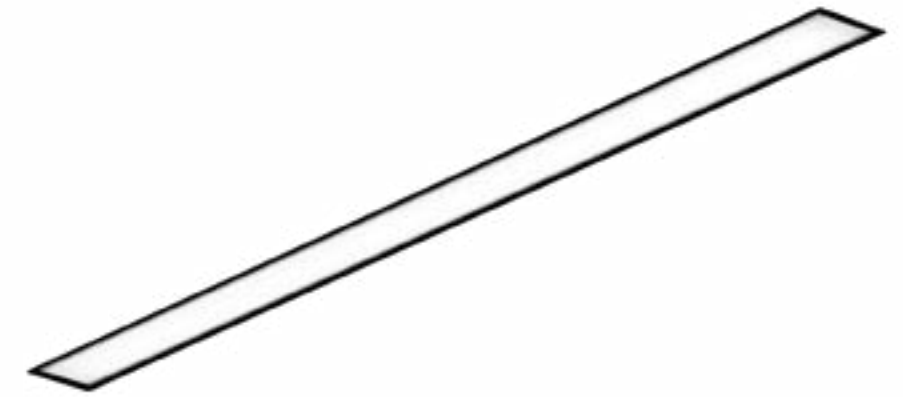

ON DEMAND

Special RAL Color
Emergency Lighting*
Motion Detection
Well-Certified LED Boards
Taylor your own design
Special Color Temperature
RGB
Thematic LED
Wireless Control Options (Casambi)
CRI 80

* Delivered separately
(not installed in luminaire).

INSTALLATIONS

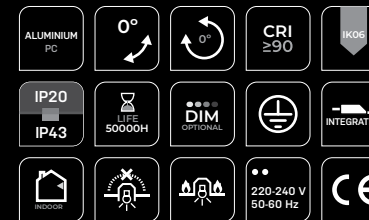

ALBA PLUS

REF 10178.RF

.PN
PENDANT

·10178 ALBA PLUS|PN
Pag. 246

.TK
TRACK

·10178 ALBA PLUS|TK
Pag. 764

.SR
SURFACE

·10178 ALBA PLUS|SR
Pag. 246

.RF
RECESSED FRAME

·10178 ALBA PLUS|RF
Pag. 452

.TR
TRIMLESS

·10178 ALBA PLUS|TR
Pag. 652

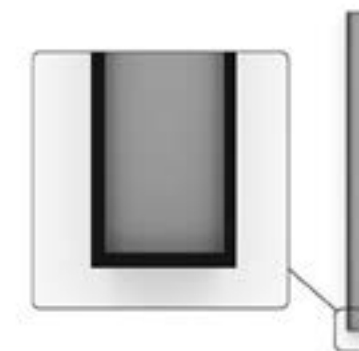

RECESSED FRAME

REF.	ELECTRIC SYSTEM LENGTH		FINISH	DIFFUSER	POWER	CRI	DOWNLIGHT *2 LUMEN				WATT		DIMM
	MM	MM					.27	.30	.40	.TW *1	K	TW	
10178	.03	843	●	.OP .MP	.ST	.9	2295	2385	2475	5700-8520	18	38	.DA .PU .D1
	.04	1124					3060	3180	3300	7600-11360	24	51	
	.05	1405					3825	3975	4125	9500-14200	30	64	
	.06	1686					4590	4770	4950	11400-17040	36	76	
	.07	1967					5355	5565	5775	13300-19880	42	89	
	.08	2248					6120	6360	6600	15200-22720	48	102	

REF.	ELECTRIC SYSTEM LENGTH		FINISH	DIFFUSER	POWER	CRI	DOWNLIGHT *2 LUMEN			WATT	DIMM
	MM	MM					.27	.30	.40		
10178	.03	843	●	.OP .MP	.HI	.9	4590	4767	4956	36	.DA .PU .D1
	.04	1124					6120	6356	6608	48	
	.05	1405					7650	7945	8260	60	
	.06	1686					9180	9534	9912	72	
	.07	1967					10710	11123	11564	84	
	.08	2248					12240	12712	13216	96	

Reference order | 10178.XX.RF.XX.XX.XX9.XX.XX

Total length = Electric System Length + 10mm + 2x8mm (Cover kit)
 (Total length - 8mm) x 73mm
 120mm

● Select finish



COMPONENTS

COVER KIT	REF.	FINISH
	TF01 2x8mm.	●

Reference order | TF01.RF.XX

REDUGER	REF.	POWER
	ACC.RG	.ST .HI

Reference order | ACC.RG.XX

JOINTS

LINEAR JOINT	ANGLE JOINT *3	T-JOINT	CROSS JOINT	WALL-CEILING JOINT	FINISH
					●
UR01	UL01	UT01	UC01	UV01	

Joints, other than Linear joint, require a technical drawing

Reference order | XX01.RF.XX

ALBA PLUS

REF 10178.RF

PHOTOMETRY



OPAL

MICROPRISMATIC

INCLUDED

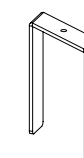

RF INSTALLATION KIT

PROFILE

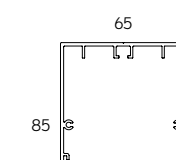

81

*1 Tunable White (TW) values correspond to 2700K and 6500K - TW is only available for DALI DT8 dimmable (.DA), CRI 80 (.8) 700mA. Los valores del blanco dinámico (TW) corresponden a 2700K y 6500K. -TW solo está disponible con protocolo DALI DT8 (.DA), CRI 80 (.8) 700mA.

*2 Down light (direct light) works at 500mA. La luz directa trabaja a 500mA.

*3 Miter cut diffuser. Difusor a inglete.

new



FINISHES

● EXTERNAL COLOR



INTERNAL COLOR



● ELECTRIC SYSTEM LENGTH mm.

843 | 1124 | 1405 | 1686 | 1967 | 2248

LIGHTING OPTIONS

■ DIFFUSERS

TRANSPARENT

POWER

STANDARD | HIGH

CRI

90

COLOR TEMPERATURE

2700K | 3000K | 4000K | TW

▼ DIMMABLE OPTIONS

DALI | 1.10 | PUSH

▲ LIGHT DISTRIBUTION

ASYMETRIC DOWN

LUMINAIRE INCLUDES

Recessed with frame mounting kit

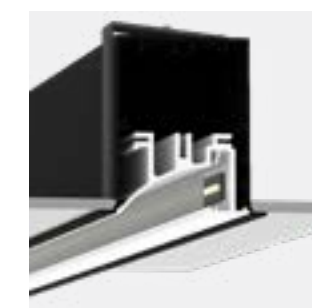

ON DEMAND

- Special RAL Color Emergency Lighting*
- Well-Certified LED Boards
- Taylor your own design
- Special Color Temperature
- RGB
- Thematic LED
- Wireless Control Options (Casambi)
- CRI 80
- Motion Detection

* Delivered separately (not installed in luminaire).

.RF
RECESSED FRAME

INSTALLATIONS



ALBA PLUS ASIMETRIC

REF 210008.RF

.PN
PENDANT

·210008 ALBA PLUS ASIMETRIC | PN - Pag. 250

.SR
SURFACE

·210008 ALBA PLUS ASIMETRIC | SR - Pag. 250

.RF
RECESSED FRAME

·210008 ALBA PLUS ASIMETRIC | RF - Pag. 456

.TR
TRIMLESS

·210008 ALBA PLUS ASIMETRIC | TR - Pag. 656

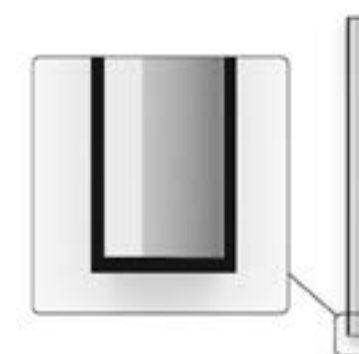

REF.	ELECTRIC SYSTEM LENGTH		FINISH	DIFFUSER	POWER	CRI	DOWNLIGHT *2 LUMEN				WATT		DIMM
	MM	MM					.27	.30	.40	.TW *1	K	TW	
210008	.03	843	●	.TP	.ST	.9	2295	2385	2475	5700-5910	18	38	.DA .PU .D1
	.04	1124					3060	3180	3300	7600-7880	24	51	
	.05	1405					3825	3975	4125	9500-9850	30	64	
	.06	1686					4590	4770	4950	11400-11820	36	76	
	.07	1967					5355	5565	5775	13300-13790	42	89	
	.08	2248					6120	6360	6600	15200-15760	48	102	

REF.	ELECTRIC SYSTEM LENGTH		FINISH	DIFFUSER	POWER	CRI	DOWNLIGHT *2 LUMEN			WATT	DIMM
	MM	MM					.27	.30	.40		
210008	.03	843	●	.TP	.HI	.9	4590	4767	4956	36	.DA .PU .D1
	.04	1124					6120	6356	6608	48	
	.05	1405					7650	7945	8260	60	
	.06	1686					9180	9534	9912	72	
	.07	1967					10710	11123	11564	84	
	.08	2248					12240	12712	13216	96	

Reference order | 210008.XX.RF.XX.XX.XX.XX.XX.XX

Total length = Electric System Length + 10mm + 2x8mm (Cover kit)
 (Total length - 8mm) x 73mm
 120mm

Select finish



COMPONENTS

COVER KIT	REF.	FINISH
	TF05 2x8mm.	●

Reference order | TF05.RF.XX

JOINTS

LINEAR JOINT
UR05



RECESSED FRAME

ALBA PLUS ASIMETRIC

REF 210008.RF

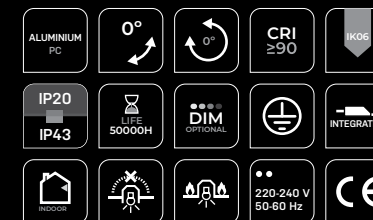

PHOTOMETRY



TRANSPARENT PC

INCLUDED



RF INSTALLATION KIT

PROFILE

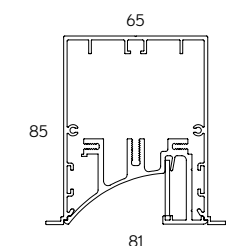

*1 Tunable White (TW) values correspond to 2700K and 6500K - TW is only available for DALI DT8 dimmable (.DA), CRI 80 (.8) 700mA. Los valores del blanco dinámico (TW) corresponden a 2700K y 6500K. -TW solo está disponible con protocolo DALI DT8 (.DA), CRI 80 (.8) 700mA.
 *2 Down light (direct light) works at 500mA. La luz directa trabaja a 500mA.



FINISHES

● COLORS



DIMENSIONS

● ELECTRIC SYSTEM LENGTH mm.

843	1124	1405	1686
800	1520	2950	5100

LIGHTING OPTIONS

■ DIFFUSERS

OPAL

POWER

STANDARD | HIGH

CRI

90

COLOR TEMPERATURE

2700K | 3000K | 4000K

▼ DIMMABLE OPTIONS

DALI | 1.10 | PUSH

▲ LIGHT DISTRIBUTION

DOWN

LUMINAIRE INCLUDES

Recessed with frame mounting kit

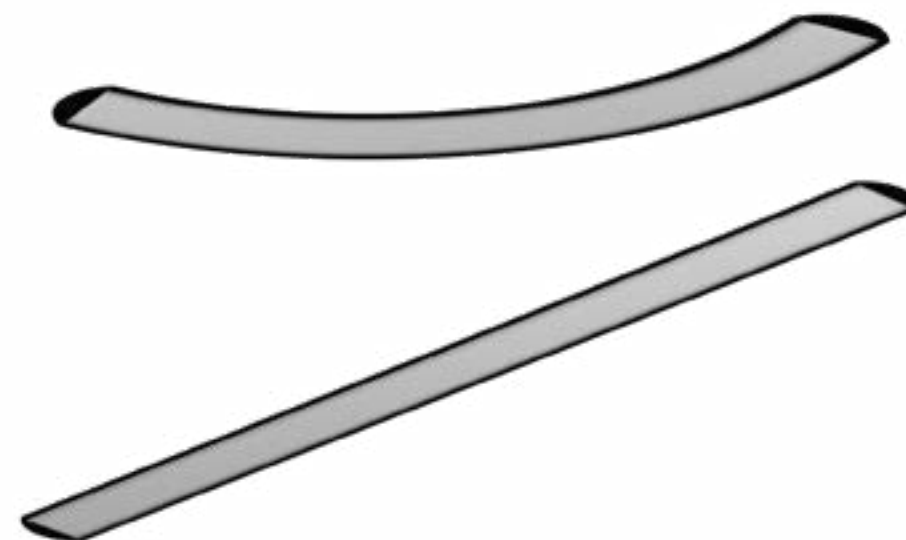

ON DEMAND

- Special RAL Color Emergency Lighting *
- Motion Detection
- Well-Certified LED Boards
- Taylor your own design
- Special Color Temperature
- RGB
- Wireless Control Options (Casambi)

* Delivered separately (not installed in luminaire).

INSTALLATIONS

.PN PENDANT

·210001 BOLD ·210015 BOLD LINE | PN
Pag. 254

.SR SURFACE

·210001 BOLD ·210015 BOLD LINE | SR
Pag. 254

.RF RECESSED FRAME

·210001 BOLD ·210015 BOLD LINE | RF
Pag. 460



BOLD | BOLD LINE

REF 210001.RF | 210015.RF



BOLD						
.01	.02	.03	.04	.05	.06	.07
800 mm 45°	800 mm 90°	1520 mm 45°	1520 mm 90°	2950 mm 45°	2950 mm 90°	5100 mm 45°

REF.	DIMENSION	FINISH	DIFFUSER	POWER	CRI	DOWNLIGHT *1 LUMEN			WATT	DIMM
						.27	.30	.40		
210001	.01	●	.OP	.ST	.9	765	795	825	6	.DA .PU .D1
	.02					1530	1590	1650	12	
	.03					1530	1590	1650	12	
	.04					3060	3180	3300	24	
	.05					3060	3180	3300	24	
	.06					6120	6360	6600	47	
	.07					5355	5565	5775	41	

REF.	DIMENSION	FINISH	DIFFUSER	POWER	CRI	DOWNLIGHT *1 LUMEN			WATT	DIMM
						.27	.30	.40		
210001	.01	●	.OP	.HI	.9	1530	1589	1652	12	.DA .PU .D1
	.02					3060	3178	3304	24	
	.03					3060	3178	3304	24	
	.04					6120	6356	6608	47	
	.05					6120	6356	6608	47	
	.06					12240	12712	13216	94	
	.07					10710	11123	11564	83	

Reference order | 210001.XX.RF.XX.XX.XX.9.XX.XX

BOLD LINE	REF.	DIMENSION		FINISH	DIFFUSER	POWER	CRI	DOWNLIGHT *1 LUMEN			WATT	DIMM	
		MM	MM					.27	.30	.40			
	210015	●	.OP	.MP	.ST	.9	.03	863	2295	2385	2475	18	.DA .PU .D1
							.04	1144	3060	3180	3300	24	
							.05	1425	3825	3975	4125	30	
							.06	1706	4590	4770	4950	35	

BOLD LINE	REF.	DIMENSION		FINISH	DIFFUSER	POWER	CRI	DOWNLIGHT *1 LUMEN			WATT	DIMM	
		MM	MM					.27	.30	.40			
	210015	●	.OP	.MP	.ST	.9	.03	863	4590	4767	4956	35	.DA .PU .D1
							.04	1144	6120	6356	6608	47	
							.05	1425	7650	7945	8260	59	
							.06	1706	9180	9534	9912	71	

Reference order | 210015.XX.SR.XX.XX.XX.9.XX.XX

COMPONENTS

COVER KIT	REF.
	TF17

Reference order | TF17.RF.XX

Select finish



BOLD | BOLD LINE

REF 210001.RF | 210015.RF

PHOTOMETRY

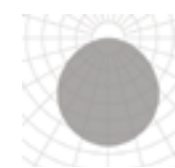

OPAL

INCLUDED



RF INSTALLATION KIT

PROFILE

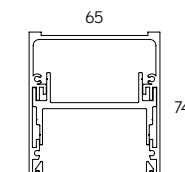

76

RECESSED FRAME



FINISHES

EXTERNAL COLOR



INTERNAL COLOR



DIMENSIONS

ELECTRIC SYSTEM LENGTH mm.

843 | 1124 | 1405 | 1686 | 1967 | 2248

LIGHTING OPTIONS

DIFFUSERS

OPAL | MICROPRISMATIC

POWER

STANDARD | HIGH

CRI

90

COLOR TEMPERATURE

2700K | 3000K | 4000K | TW

DIMMABLE OPTIONS

DALI | 1.10 | PUSH

LIGHT DISTRIBUTION

DOWN

LUMINAIRE INCLUDES

Recessed with frame mounting kit



ON DEMAND

Special RAL Color
Emergency Lighting *
Motion Detection
Well-Certified LED Boards
Special Color Temperature
RGB
Thematic LED
Wireless Control Options (Casambi)
CRI 80

* Delivered separately
(not installed in luminaire).

RECESSED FRAME

INSTALLATIONS

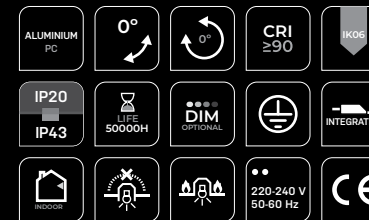

WING

REF 10200.RF

.PN
PENDANT

10200 WING | PN
Pag. 262

.SR
SURFACE

10200 WING | SR
Pag. 262

.RF
RECESSED FRAME

10200 WING | RF
Pag. 464

.TR
TRIMLESS

10200 WING | TR
Pag. 660

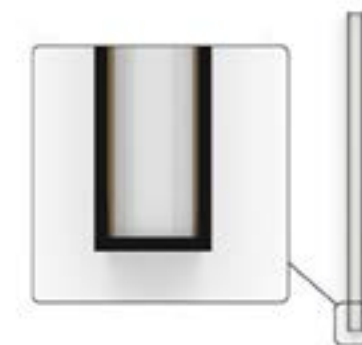

REF.	ELECTRIC SYSTEM LENGTH		FINISH	DIFFUSER	POWER	CRI	DOWNLIGHT *2 LUMEN				WATT		DIMM
	MM	MM					.27	.30	.40	.TW *1	K	TW	
10200	.03	843	●	.OP .MP	.ST	.9	2295	2385	2475	5700-5910	18	38	.DA .PU .D1
	.04	1124					3060	3180	3300	7600-7880	24	51	
	.05	1405					3825	3975	4125	9500-9850	30	64	
	.06	1686					4590	4770	4950	11400-11820	36	76	
	.07	1967					5355	5565	5775	13300-13790	42	89	
	.08	2248					6120	6360	6600	15200-15760	48	102	

REF.	ELECTRIC SYSTEM LENGTH		FINISH	DIFFUSER	POWER	CRI	DOWNLIGHT *2 LUMEN			WATT	DIMM
	MM	MM					.27	.30	.40		
10200	.03	843	●	.OP .MP	.HI	.9	4590	4767	4956	36	.DA .PU .D1
	.04	1124					6120	6356	6608	48	
	.05	1405					7650	7945	8260	60	
	.06	1686					9180	9534	9912	72	
	.07	1967					10710	11123	11564	84	
	.08	2248					12240	12712	13216	96	

Reference order | 10200.XX.RF.XX.XX.XX.X.XX.XX

Total length = Electric System Length + 10mm + 2x8mm (Cover kit)
 (Total length - 8mm) x 61mm
 120mm

COMPONENTS

COVER KIT	REF.	FINISH
	TF13 2x8mm.	●

Reference order | TF13.RF.XX

REDUGER	REF.	POWER
	ACC.RG	.ST .HI

Reference order | ACC.RG.XX

JOINTS

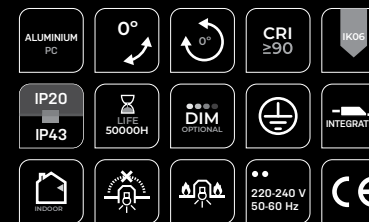
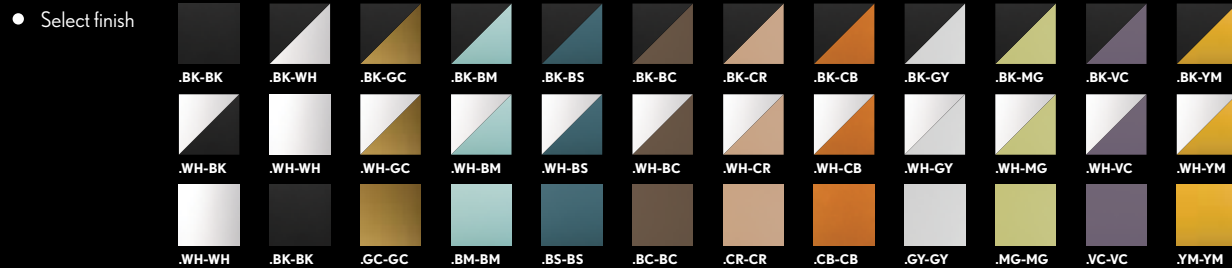

WING

REF 10200.RF

PHOTOMETRY

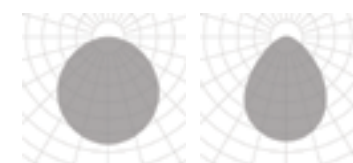

OPAL MICROPRISMATIC

INCLUDED



RF INSTALLATION KIT



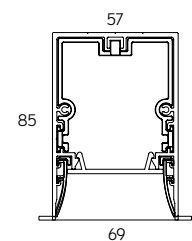





PROFILE

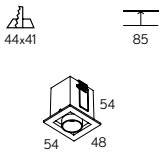

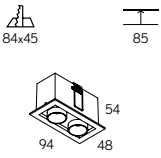
*1 Tunable White (TW) values correspond to 2700K and 6500K - TW is only available for DALI DT8 dimmable (DA), CRI 80 (8) 700mA. Los valores del blanco dinámico (TW) corresponden a 2700K y 6500K. -TW solo está disponible con protocolo DALI DT8 (DA), CRI 80 (8) 700mA.
 *2 Down light (direct light) works at 500mA. La luz directa trabaja a 500mA.

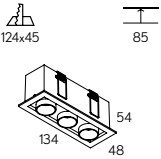
RECESSED FRAME

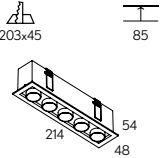
.RF

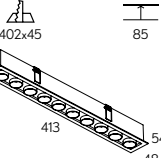
OKKO MODULAR	REF.	DIMENSIONS	FINISHES	LAMP	OPTIC OPTIONS	POWER	CRI	K	LUMEN	WATT	mA	DIMM	SKETCH
	410012	.01*	●	.LED	.20 .40 .60	.ST	.9	.27 .30 .40	94 105 112	1	100	.DA .PU .D1	
	410012	.02	●	.LED	.20 .40 .60	.ST	.9	.27 .30 .40	118 132 140	2	200	.DA .PU .D1	
	410012	.03	●	.LED	.20 .40 .60	.ST	.9	.27 .30 .40	135 151 160	3	300	.DA .PU .D1	
	410012	.05	●	.LED	.20 .40 .60	.ST	.9	.27 .30 .40	189 211 224	5	500	.DA .PU .D1	
	410012	.10	●	.LED	.20 .40 .60	.ST	.9	.27 .30 .40	947 1058 1122	10	500	.DA .PU .D1	

● Select finishes

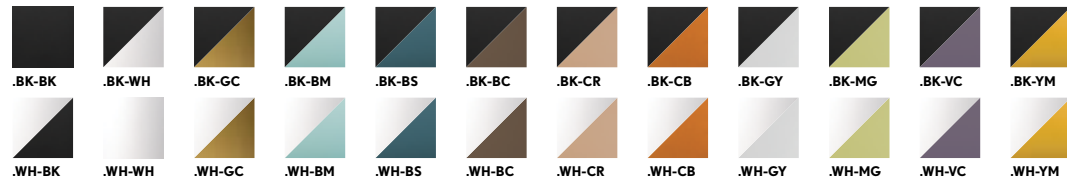

Reference order 410012.XX.RF.XX.XX.ST.9.XX.XX

*1 Driver dimensions are greater than those of the cut-out-hole. Dimming options require the combination of a minimum of 3 luminaires. Las dimensiones del driver son superiores a las del agujero de corte. Las opciones de regulación necesitan la combinación de un mínimo de 3 luminarias.

● FINISHES

EXTERNAL COLOR



INTERNAL COLOR



DIMENSIONS

● View in family specifications

.01 | .02 | .03 | .05 | .10

LIGHTING OPTIONS

■ BEAM ANGLE

20° | 40° | 60°

POWER

STANDARD

CRI

90

COLOR TEMPERATURE

2700K | 3000K | 4000K

▼ DIMMABLE OPTIONS

DALI | 1.10 | PUSH

▲ LIGHT DISTRIBUTION

DOWN

ON DEMAND

Dim to Warm
Tunable White
Wireless Control Options



INSTALLATIONS

.PN
PENDANT

·210012 OKKO MODULAR LINE|
PN - Pag. 150

.SR
SURFACE

·210012 OKKO MODULAR LINE|
SR - Pag. 150

.RF
RECESSED FRAME

·410012 OKKO MODULAR | RF-Pag.
468

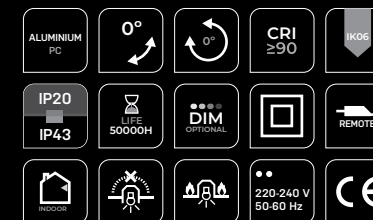



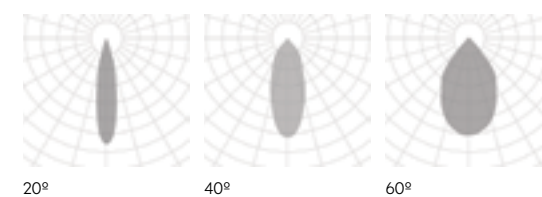





PHOTOMETRY

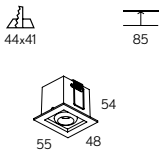

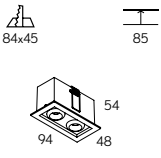
OKKO
MODULAR

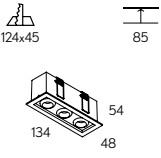
REF 410012.RF

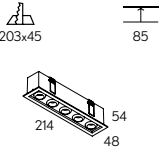
RECESSED FRAME

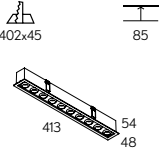
OKKO PLUS MODULAR	REF.	DIMENSIONS	FINISHES	LAMP	OPTIC OPTIONS	POWER	CRI	K	LUMEN	WATT	mA	DIMM	SKETCH
	410013	.01*	●	.LED	.20 .40 .60	.ST	.9	.27 .30 .40	94 105 112	2	100	.DA .PU .D1	
	410013	.02	●	.LED	.20 .40 .60	.ST	.9	.27 .30 .40	118 132 140	3	200	.DA .PU .D1	
	410013	.03	●	.LED	.20 .40 .60	.ST	.9	.27 .30 .40	135 151 160	5	300	.DA .PU .D1	
	410013	.05	●	.LED	.20 .40 .60	.ST	.9	.27 .30 .40	189 211 224	7	500	.DA .PU .D1	
	410013	.10	●	.LED	.20 .40 .60	.ST	.9	.27 .30 .40	947 1058 1122	12	500	.DA .PU .D1	

● Select finishes

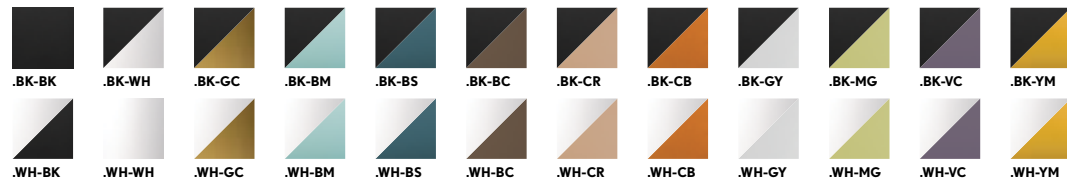

Reference order 410013.XX.RF.XX.XX.ST.9.XX.XX

*1 Driver dimensions are greater than those of the cut-out-hole. Dimming options require the combination of a minimum of 3 luminaires. Las dimensiones del driver son superiores a las del agujero de corte. Las opciones de regulación necesitan la combinación de un mínimo de 3 luminarias.

● FINISHES

EXTERNAL COLOR



INTERNAL COLOR



DIMENSIONS

● View in family specifications

.01 | .02 | .03 | .05 | .10

LIGHTING OPTIONS

■ BEAM ANGLE

20° | 40° | 60°

POWER

STANDARD

CRI

90

COLOR TEMPERATURE

2700K | 3000K | 4000K

▼ DIMMABLE OPTIONS

DALI | 1.10 | PUSH

▲ LIGHT DISTRIBUTION

DOWN

ON DEMAND

Dim to Warm
Tunable White
Wireless Control Options



.RF

RECESSED FRAME

INSTALLATIONS

.PN
PENDANT

·210013 OKKO PLUS MODULAR
LINE | PN - Pag. 154

.SR
SURFACE

·210013 OKKO PLUS MODULAR
LINE | SR - Pag. 154

.RF
RECESSED FRAME

·410013 OKKO PLUS MODULAR |
RF - Pag. 470

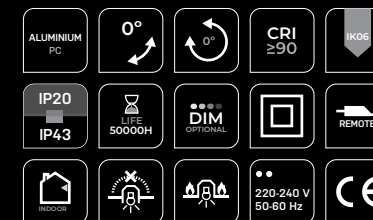

OKKO PLUS
MODULAR

REF 410013.RF

PHOTOMETRY

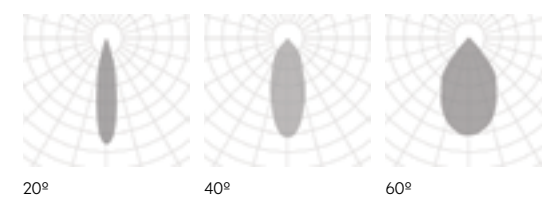

LENT MODULAR	REF.	DIMENSIONS	SHAPE	FINISHES	LAMP	OPTIC OPTIONS	POWER	CRI	K	LUMEN	WATT	mA	DIMM*	SKETCH
	10216	.01	.RD .SQ	●	.LED	.20 .40 .60	.ST	.9	.27 .30 .40	161 169 176	2	700	.DA .PU .D1	
	10216	.03	.RD .SQ	●	.LED	.20 .40 .60	.ST	.9	.27 .30 .40	443 507 528	6	700	.DA .PU .D1	
	10216	.05	.RD .SQ	●	.LED	.20 .40 .60	.ST	.9	.27 .30 .40	805 845 880	10	700	.DA .PU .D1	
	10216	.10	.RD .SQ	●	.LED	.20 .40 .60	.ST	.9	.27 .30 .40	1603 1690 1760	20	700	.DA .PU .D1	

Reference order | 10216.XX.RF.XX.XX.XX.ST9.XX.XX

● Select finishes

FINISHES

EXTERNAL COLOR

INTERNAL COLOR

DIMENSIONS

View in family specifications

.01 | .03 | .05 | .10

LIGHTING OPTIONS

BEAM ANGLE

20° | 40° | 60°

POWER

STANDARD

CRI

90

COLOR TEMPERATURE

2700K | 3000K | 4000K

DIMMABLE OPTIONS

DALI | 1.10 | PUSH

LIGHT DISTRIBUTION

DOWN

ON DEMAND

Dim to Warm
Tunable White
Wireless Control Options

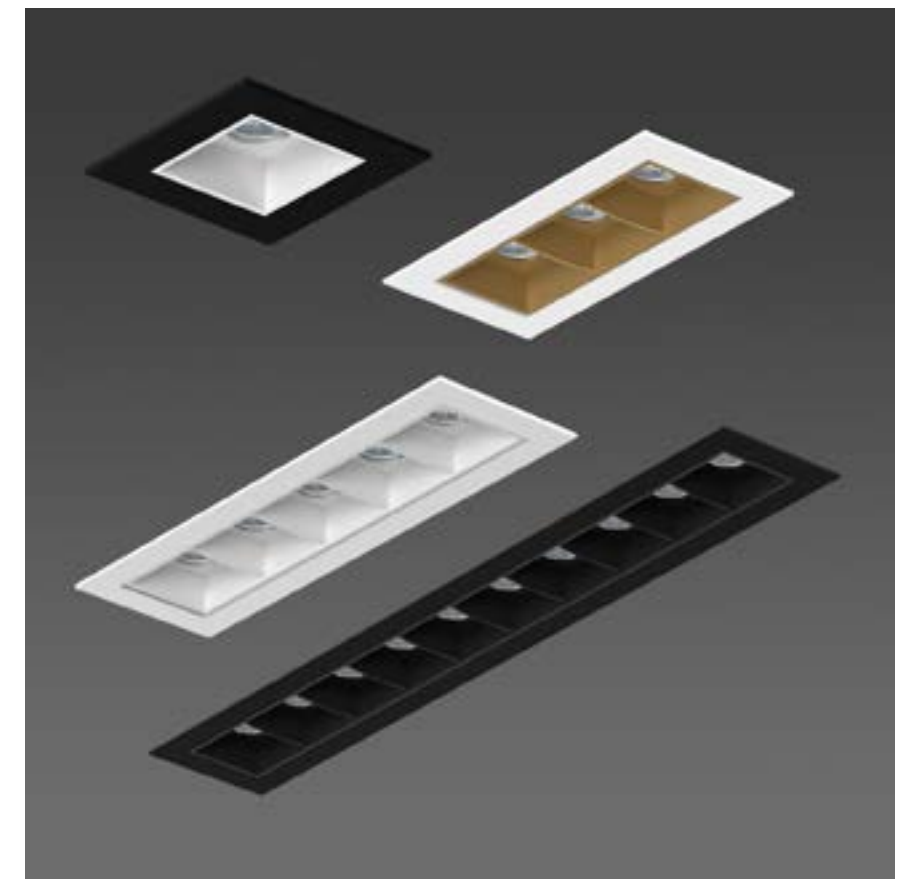

INSTALLATIONS

- .RF**
RECESSED FRAME
10216 LENT MODULAR | RF
Pag. 472
- .TR**
TRIMLESS
10216 LENT MODULAR | TR
Pag. 666

ALUMINUM PC	0°	0°	CRI ≥90	IK05
IP20 IP43	LIFE 50000H	DIM OPTIONAL	REMOTE	
RECESSED	RECESSED	220-240 V 50-60 Hz	CE	

PHOTOMETRY

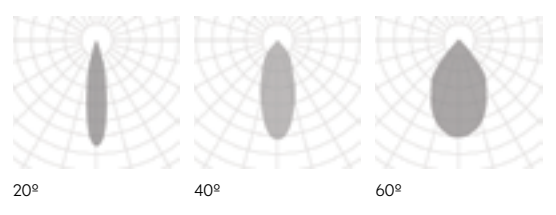

LENT MODULAR

REF 10216.RF

RECESSED FRAME

LENT MOTION	REF.	DIMENSIONS	SHAPE	FINISHES	LAMP	OPTIC OPTIONS	POWER	CRI	K	LUMEN	WATT	mA	DIMM*	SKETCH
	10212	.03	.RD .SQ	●	.LED	.20 .40 .60	.ST	.9	.27 .30 .40	483 507 528	6	700	.DA .PU .D1	
	10212	.05	.RD .SQ	●	.LED	.20 .40 .60	.ST	.9	.27 .30 .40	805 845 880	10	700	.DA .PU .D1	
	10212	.10	.RD .SQ	●	.LED	.20 .40 .60	.ST	.9	.27 .30 .40	1603 1690 1760	20	700	.DA .PU .D1	

Reference order | 10212.XX.RF.XX.XX.XX.ST9.XX.XX

Select finishes

FINISHES

EXTERNAL COLOR

INTERNAL COLOR

DIMENSIONS

View in family specifications

.03 | .05 | .10

LIGHTING OPTIONS

BEAM ANGLE

20° | 40° | 60°

POWER

STANDARD

CRI

90

COLOR TEMPERATURE

2700K | 3000K | 4000K

DIMMABLE OPTIONS

DALI | 1.10 | PUSH

LIGHT DISTRIBUTION

DOWN

ON DEMAND

Dim to Warm
Tunable White
Wireless Control Options



INSTALLATIONS

ALUMINIUM PC	90°	0°	CRI ≥90	IK05
IP20 IP43	LIFE 50000H	DIM OPTIONAL	REMOTE	
RECESSED		220-240 V 50-60 Hz	CE	

LENT MOTION

REF 10212.RF

PHOTOMETRY

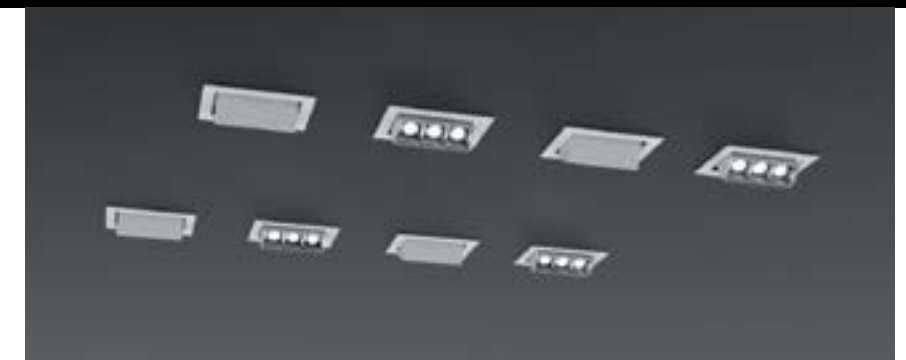
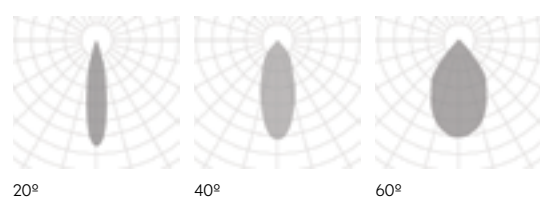

.RF
RECESSED FRAME

10212 LENT MOTION | RF
Pag. 474

.RF
RECESSED FRAME

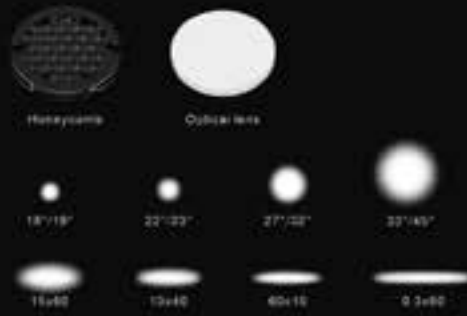

OPTICAL ACCESORIES



TILTING 30°

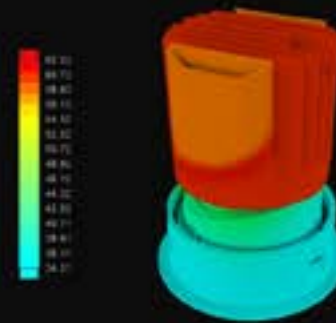

HEAT DISSIPATION THEORY

SASSY



new

A new era in LED lighting

Specific and efficient. This is your new go-to LED lighting solution. It gets five stars for its lighting capacity and has brilliant accessories that give you the highest possible performance.

Una nueva era en la iluminación LED

Especialización y eficacia. Así es el nuevo modelo de referencia en iluminación LED. Un 5 estrellas por su capacidad lumínica pero especialmente por los accesorios que aporta y acopla para conseguir el mayor rendimiento posible.

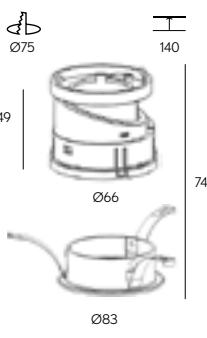
SASSY	REF.	DIMENSIONS	FINISHES	SKETCH
	410002	.01	.WH.WH .BK-BK	

Reference order 410002.01.RF.XX

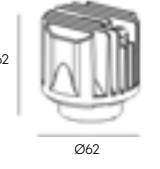
SASSY LED	REF.	DIMENSIONS	FINISHES	OPTIC OPTIONS	POWER	CRI	K	LUMEN	WATT	mA	DIMM*	SKETCH
	120001	.01	.BK-BK	.15 .26 .38 .60	.ST	.9	.27	1006	10	250	.DA .PU .D1	
							.30	1073				
							.40	1160				
					.DW	.9	.27	1548	15	350	.DA .PU .D1	
							.30	1650				
							.40	1784				
					.DW	.9	.27	2090	7	420 to 14	.DA .PU .D1	
							.30	2228				
							.40	2409				
					.DW	.9	.27	2090	20	500	.DA .PU .D1	
							.30	2228				
							.40	2409				
.DW	.9	.27	2090	10	280 to 14	.DA						
		.30	2228									
		.40	2409									

Reference order 120001.01.BK-BK.XX.XX.XX.XX

FINISHES

EXTERNAL COLORS



INTERNAL COLORS



DIMENSIONS

View in family specifications

.01

LIGHTING OPTIONS

BEAM ANGLE

15° | 26° | 38° | 60°

POWER

STANDARD | MIDDLE | HIGH

CRI

90

COLOR TEMPERATURE

2700K | 3000K | 4000K | DW

DIMMABLE OPTIONS

DALI | 1.10 | PUSH

LIGHT DISTRIBUTION

DOWN

ON DEMAND

Tunable White
Wireless Control Options



INSTALLATIONS

.RF
RECESSED FRAME

410002 SASSY | RF
Pag. 476

.TR
TRIMLESS

410002 SASSY | TR
Pag. 668



PHOTOMETRY

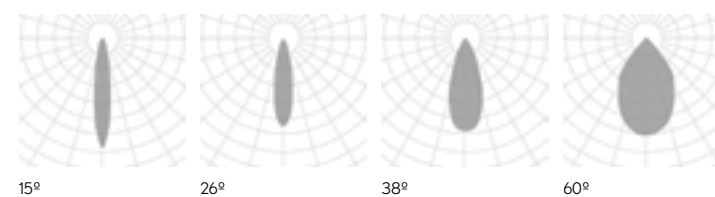

SASSY



REF 410002.RF



COMPONENTS





RING PART	FINISH
	.BK-BK .CH-CH .WH-WH .MS-MS .GF-GF
ACC410002.RR	

Reference order | ACC410002.RR.XX





RING PART			FINISH
			.BK-BK .WH-WH .BK-WH
ACC410002.TBR	ACC410002.OVR	ACC410002.CFR	

Reference order | ACC410002.XX.XX

ACCESORIES

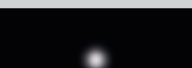
OVAL FLOOD LENS *1	REF.	LENSE EFFECT	SKETCH
	ACC410002.OV	.03X60	6,4  Ø37,5
		.10X60	
		.10X40	
		.15X60	

Reference order | ACC410002.OV.XX

FLOOD LENS *1	REF.	LENSE EFFECT	SKETCH
	ACC410002	.ZSX1.3	6,4  Ø37,5
		.ZSX1.5	
		.ZSX2	
		.ZSX3	

Reference order | ACC410002.XX

HONEYCOMB

ACC410002.HC

*1 Only compatible with ring part ACC410002.RR. Solo compatible con marco ACC410002.RR.

*1 For best performance, optic lenses are only recommended with the smallest beam angle .15.
 Para garantizar un resultado óptimo, las lentes solo se recomiendan para la óptica de menor tamaño .15

Select 3 components to form your final luminaire: Sassy + Sassy LED + Ring part. Selecciona 3 componentes para formar la luminaria definitiva: Sassy + Sassy LED + Ring part.

Select finish

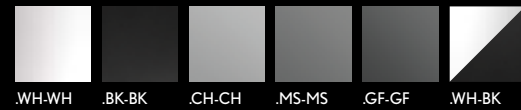

.RF
 RECESSED FRAME

SASSY

REF 410002.RF

new

IP 65

SASSY SQ	REF.	DIMENSIONS	FINISHES	SKETCH
	410003	.01	.WH.WH .BK-BK	

Reference order 410003.01.RF.XX

SASSY LED	REF.	DIMENSIONS	FINISHES	OPTIC OPTIONS	POWER	CRI	K	LUMEN	WATT	mA	DIMM*	SKETCH
	120001	.01	.BK-BK	.15 .26 .38 .50	.ST	.9	.27	1006	10	250	.DA .PU .D1	
							.30	1073				
							.40	1160				
							.DW	627 to 14				
					.MD	.9	.27	1548	15	350	.DA .PU .D1	
							.30	1650				
							.40	1784				
							.DW	713 to 14				
					.HI	.9	.27	2090	20	500	.DA .PU .D1	
							.30	2228				
							.40	2409				
							.DW	880 to 30				

Reference order 120001.01.BK-BK.XX.XX.X.XX.XX

FINISHES

EXTERNAL COLORS



INTERNAL COLORS



DIMENSIONS

View in family specifications

.01

LIGHTING OPTIONS

BEAM ANGLE

15° | 26° | 38° | 60°

POWER

STANDARD | MIDDLE | HIGH

CRI

90

COLOR TEMPERATURE

2700K | 3000K | 4000K | DW

DIMMABLE OPTIONS

DALI | 1.10 | PUSH

LIGHT DISTRIBUTION

DOWN

ON DEMAND

Tunable White
Wireless Control Options

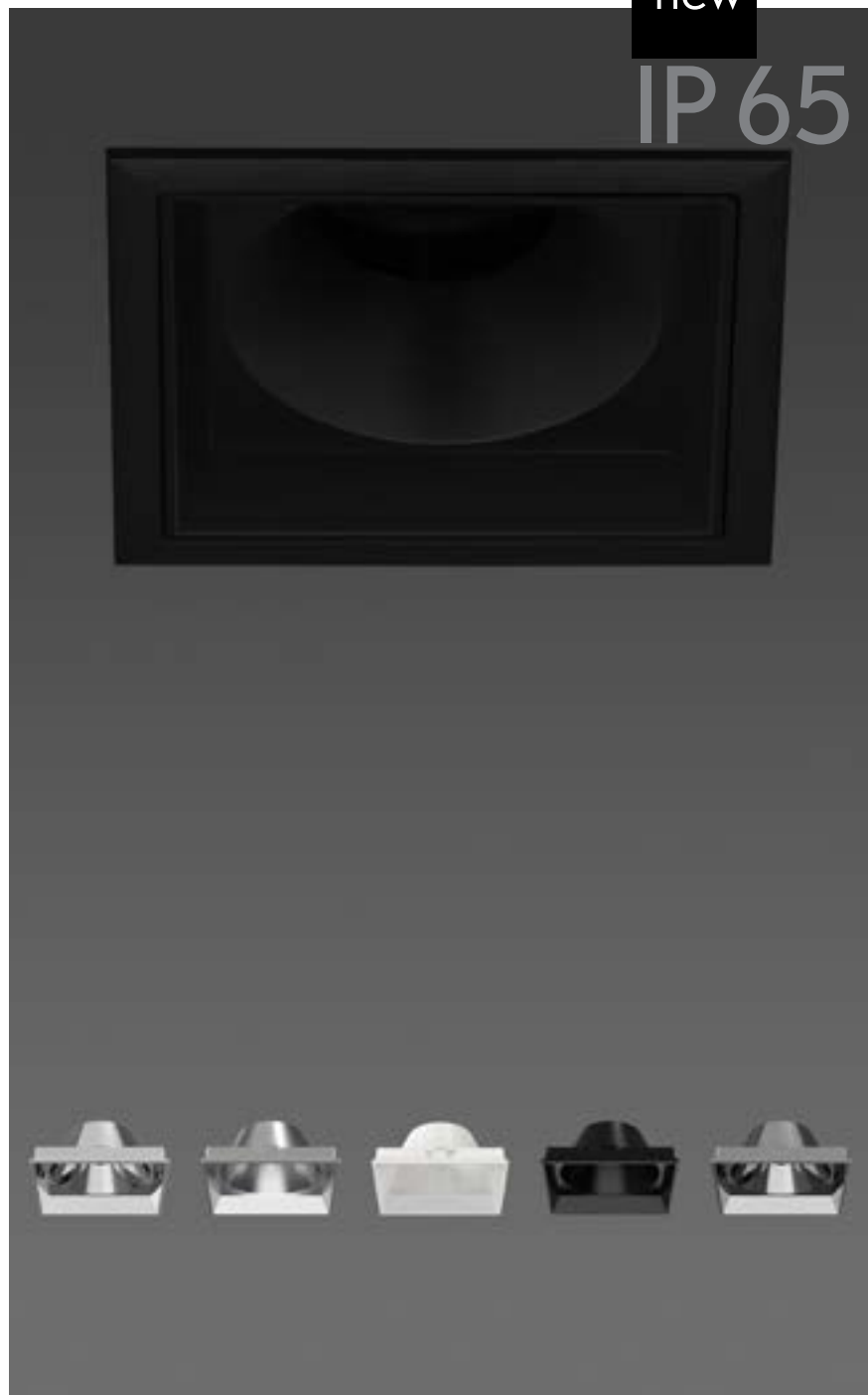

.RF

RECESSED FRAME

INSTALLATIONS

.RF
RECESSED FRAME

·410003 SASSY SQ | RF
Pag. 482

.TR
TRIMLESS

·410003 SASSY SQ | TR
Pag. 672



SASSY SQ

REF 410003.RF

PHOTOMETRY

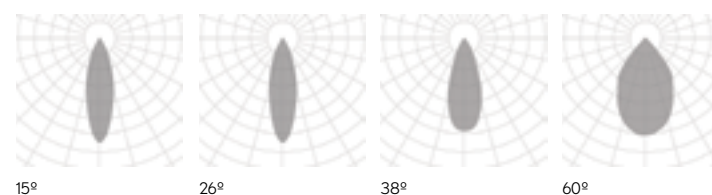









COMPONENTS

RING PART	FINISH
	.BK-BK .CH-CH .WH-WH .MS-MS .GF-GF
ACC410003.SQR	

Reference order | ACC410003.SQR.XX

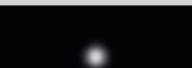
ACCESORIES

OVAL FLOOD LENS *1	REF.	LENSE EFFECT	SKETCH
	ACC410002.OV	.03X60	
		.10X60	
		.10X40	
		.15X60	

FLOOD LENS *1	REF.	LENSE EFFECT	SKETCH
	ACC410002	.ZSX1.3	
		.ZSX1.5	
		.ZSX2	
		.ZSX3	

HONEYCOMB

ACC410002.HC

Reference order | ACC410003.OV.XX

Reference order | ACC410003.XX

*1 For best performance, optic lenses are only recommended with the smallest beam angle .15.
Para garantizar un resultado óptimo, las lentes solo se recomiendan para la óptica de menor tamaño .15

Select 3 components to form your final luminaire: Sassy SQ + Sassy LED + Ring part. Selecciona 3 componentes para formar la luminaria definitiva: Sassy SQ + Sassy LED + Ring part.



.RF
RECESSED FRAME

• Select finish

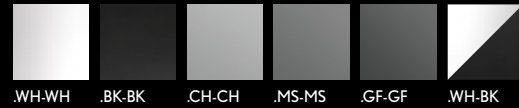

SASSY SQ

REF 410003.RF

VIO

Re -framing spaces

Focus on something specific or set the mood for the entire room.

Removable LED modules, a choice of fixed and adjustable assembly modes (4+4) and textured black and white finishes make them your best ally for achieving the pleasing effect you need. Welcome to your blank page.

Let your imagination fly, then watch as the VIO product family sets the stage. And when you have finished lighting, if you like, hit the Re-frame button.

Re-encuadre de espacios

Poner el foco en un elemento concreto o tamizar una estancia completa.

Gracias a sus módulos LED extraíbles, su capacidad de montaje en modo orientado o fijo (4+4) y sus acabados en negro texturizado o blanco, VIO se convierte en el mejor aliado para dibujar el escenario que necesitas.

Bienvenido a un espacio aún por definir. Imagínalo y deja que la familia de productos VIO defina el encuadre. ¡Y una vez iluminado, reencuádralo!





FINISHES

COLORS



DIMENSIONS

View in family specifications

.01

LIGHTING OPTIONS

BEAM ANGLE

9° | 12° | 30° | 16° | 24° | 38°

POWER

STANDARD | HIGH

CRI

90

COLOR TEMPERATURE

2700K | 3000K | 4000K

DIMMABLE OPTIONS

DALI | 1.10 | PUSH

LIGHT DISTRIBUTION

DOWN

ON DEMAND

Wireless Control Options

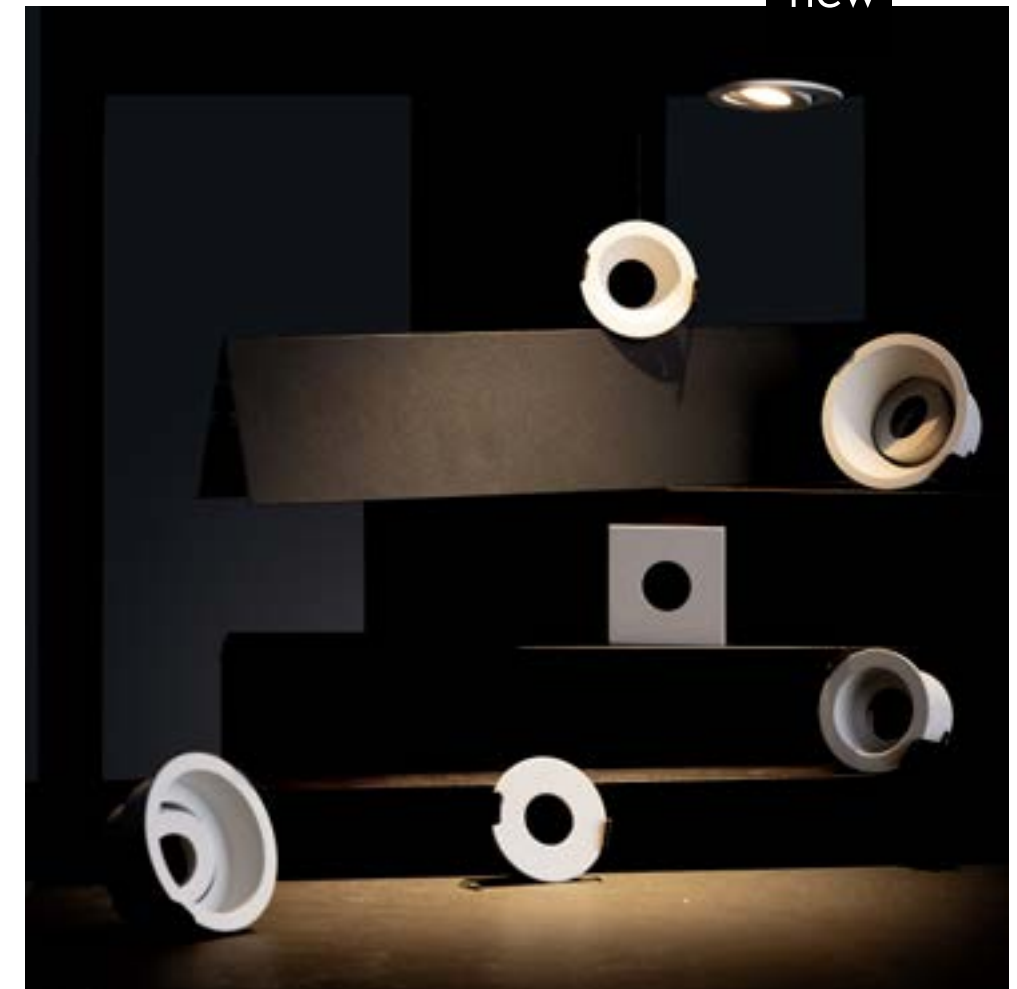

INSTALLATIONS



VIO
 VIO | SQ | DEEP | DOME
 VIO MOVE | SQ MOVE | DEEP MOVE | DOME MOVE
 REF 2018X.RF

.RF
 RECESSED FRAME

·2018X VIO | RF
 Pag. 488

.RF
 RECESSED FRAME

VIO MOVE	REF.	DIMENSIONS	FINISHES	SKETCH
	20184	.01	●	

VIO SQ MOVE	REF.	DIMENSIONS	FINISHES	SKETCH
	20180	.01	●	

VIO DEEP MOVE	REF.	DIMENSIONS	FINISHES	SKETCH
	20187	.01	●	

VIO DOME MOVE	REF.	DIMENSIONS	FINISHES	SKETCH
	20182	.01	●	

VIO	REF.	DIMENSIONS	FINISHES	SKETCH
	20185	.01	●	

VIO SQ	REF.	DIMENSIONS	FINISHES	SKETCH
	20181	.01	●	

VIO DEEP	REF.	DIMENSIONS	FINISHES	SKETCH
	20186	.01	●	

VIO DOME	REF.	DIMENSIONS	FINISHES	SKETCH
	20183	.01	●	

VIOLED	REF.	FINISHES	LAMP	OPTIC OPTIONS	POWER	CRI	K	LUMEN	WATT	mA	DIMM**	SKETCH
	VL	●	LED	.9 .12 .30	.ST	.9	.27	156	3	700	-	
							.30	165				
							.40	172				
	VL	●	LED	.16 .24 .38	.HI	.9	.27	391	7	500	-	
							.30	402				
							.40	458				

Reference order | VL.XX.XX.XX9.XX

VIO DRIVERS	DIMENSION	POWER	DIMM
DRVL	.01 2 - 3 vio	.ST	.DA
	.02 4 - 9 vio		.PU
	.03 10 - 15 vio		.D1
	.01 1 - 3 vio	.HI	.DA
	.02 4 - 8 vio		.PU
			.D1

Reference order | DRVL.XX.XX.XX

* Diabla driver dimensions are greater than those of the cut-out-hole. Diming options require the combination of a minimum of 2 luminaires. The "DRVL .ST" dimming options require the combination of a minimum of 2 luminaires. Las dimensiones del driver dimable son superiores a las del agujero de corte. Las opciones de regulación necesitan la combinación de un mínimo de 2 luminarias. Las opciones de regulación "DRVL .ST" necesitan la combinación de un mínimo de 2 luminarias.

* $.ST = H + 51$ | $.HI = H + 76$

● Select finishes

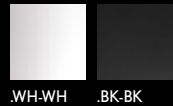

- ALUMINIUM PC
- 10°
- 0°
- CRI ≥ 90
- IP20
- IP23
- LIFE 50000H
- DIM OPTIONAL
- REMOTE
- RECORD
- 220-240 V 50-60 Hz
- CE

VIO
VIO | SQ | DEEP | DOME
VIO MOVE | SQ MOVE | DEEP MOVE | DOME MOVE
REF 2018X.RF

PHOTOMETRY

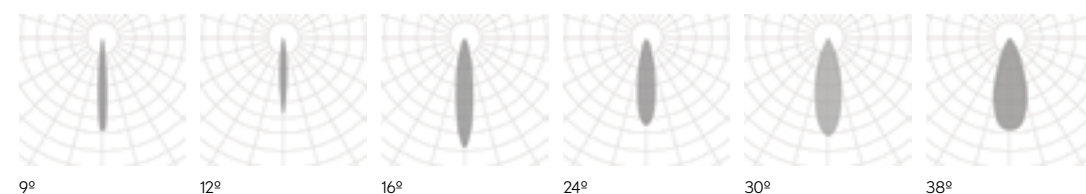

9° 12° 16° 24° 30° 38°

new

GALANTA DEEP	REF.	DIMENSIONS	FINISHES	LAMP	DIFFUSER	POWER	CRI	K	LUMEN	WATT	mA	DIMM*	SKETCH
	410001	.01	●	LED	.OP	.ST	.9	.27	324	5	500	.DA .PU .D1	
								.30	345				
								.40	417				
	410001	.02	●	LED	.OP	.ST	.9	.27	527	8	500	.DA .PU .D1	
								.30	465				
								.40	430				
	410001	.03	●	LED	.OP	.ST	.9	.27	768	12	500	.DA .PU .D1	
								.30	694				
								.40	641				

Reference order | 410001.XX.RF.XX.XX.ST9.XX.XX

Select finishes

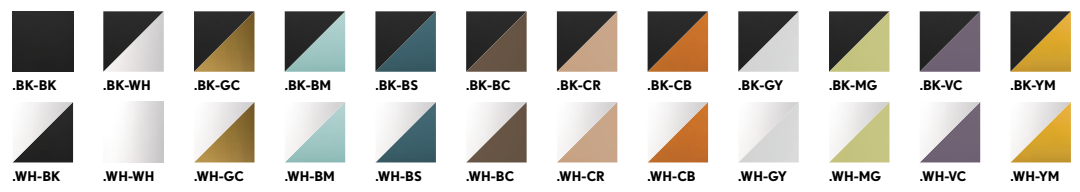

FINISHES

EXTERNAL COLOR

INTERNAL COLOR

DIMENSIONS

View in family specifications

.01 | .02 | .03

LIGHTING OPTIONS

DIFFUSER

POWER

CRI

COLOR TEMPERATURE

DIMMABLE OPTIONS

LIGHT DISTRIBUTION

ON DEMAND

Dim to Warm
Tunable White
Wireless Control Options



INSTALLATIONS

GALANTA DEEP

REF 410001.RF

PHOTOMETRY



.RF
RECESSED FRAME
-410001 GALANTA DEEP | RF
Pag. 492

RECESSED FRAME .RF

MARTORELL	REF.	DIMENSIONS	FINISHES	LAMP	OPTIC OPTIONS	POWER	CRI	K	LUMEN	WATT	mA	DIMM	SKETCH
	20115	.01*2	.BK-BK .WH-WH	LED	.15 .24 .32	.ST	.9	.27 .30 .40	175 188 199	3	700	.DA*1 .PU*1 .D1*1	
	20115	.02	●	LED	.15 .24 .32	.ST	.9	.27 .30 .40	470 498 515	8	700	.DA .PU .D1	
	20115	.03	●	LED	.24 .32 .43	.ST	.9	.27 .30 .40	1071 1156 1198	12	350	.DA .PU .D1	

Reference order 20115.XX.RF.XX.XX.ST9.XX.XX

● Select finishes

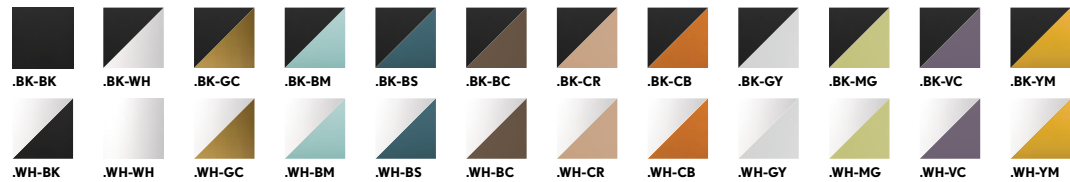

*1 Dimm options require the combination of a minimum of 2 luminaires. Las opciones de regulación necesitan la combinación de un mínimo de 2 luminarias.

*2 Dimmable driver dimensions are greater than those of the cut-out-hole. Las dimensiones del driver regulable son superiores a las del agujero de corte.

● FINISHES

EXTERNAL COLOR



INTERNAL COLOR



DIMENSIONS

● View in family specifications

.01 | .02 | .03

LIGHTING OPTIONS

■ BEAM ANGLE

15° | 24° | 32° | 43°

POWER

STANDARD

CRI

90

COLOR TEMPERATURE

2700K | 3000K | 4000K

▼ DIMMABLE OPTIONS

DALI | 1.10 | PUSH

▲ LIGHT DISTRIBUTION

DOWN

ON DEMAND

Dim to Warm (.02, .03)
Tunable White (.02, .03)
Honey Comb (.03)
Wireless Control Options
Special RAL Color



RECESSED FRAME

INSTALLATIONS



.PN
PENDANT

·20115 MARTORELL | PN
Pag. 322

.TK
TRACKLIGHT

·20115 MARTORELL | TK
Pag. 744

.SR
SURFACE

·20115 MARTORELL | SR
Pag. 322

.RF
RECESSED FRAME

·20115 MARTORELL | RF
Pag. 494

.TR
TRIMLESS

·20115 MARTORELL | TR
Pag. 676

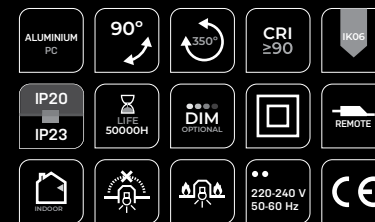



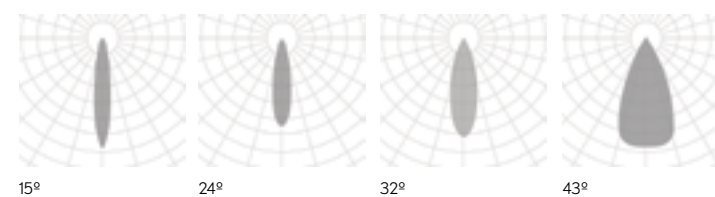

PHOTOMETRY

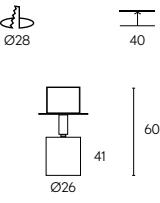

MARTORELL

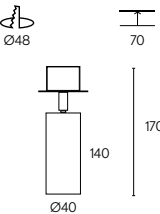
REF 20115.RF

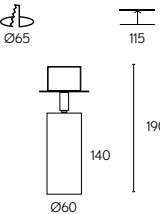
MARTORELL MOVE	REF.	DIMEN- SIONS	FINISHES	LAMP	OPTIC OPTIONS	POWER	CRI	K	LUMEN	WATT	mA	DIMM	SKETCH
	20110	.01	●	LED	.20 .40 .60	.ST	.9	.27	167	3	700	.DA .PU .D1	
								.30	184				
								.40	206				
	20110	.02	●	LED	.18 .25 .35	.ST	.9	.27	465	9	700	.DA .PU .D1	
								.30	507				
								.40	548				
	20110	.03	●	LED	.18 .25 .35	.ST	.9	.27	1058	15	350	.DA .PU .D1	
								.30	1096				
								.40	1231				

Reference order | 20110.XX.RF.XX.XX.ST9.XX.XX

Select finishes

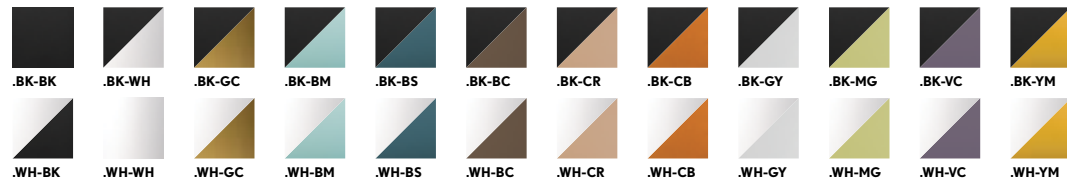

FINISHES

EXTERNAL COLOR



INTERNAL COLOR



DIMENSIONS

View in family specifications

.01 | .02 | .03

LIGHTING OPTIONS

BEAM ANGLE

20° 40° 60° | 18° 25° 35° | 18° 25° 35°

POWER

STANDARD

CRI

90

COLOR TEMPERATURE

2700K | 3000K | 4000K

DIMMABLE OPTIONS

DALI | 1.10 | PUSH

LIGHT DISTRIBUTION

DOWN

ON DEMAND

Dim to Warm (.02, .03)
Tunable White (.02, .03)
Honey Comb (.03)
Wireless Control Options



INSTALLATIONS



.SR
SURFACE

·20110 MARTORELL MOVE | SR
Pag. 324



.RF
RECESSED FRAME

·20110 MARTORELL MOVE | RF
Pag. 496

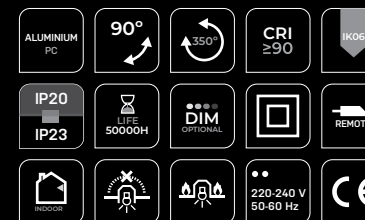

MARTORELL MOVE

REF 20110.RF

PHOTOMETRY

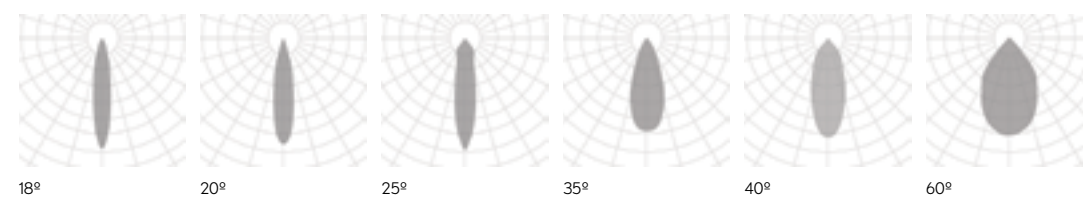

RECESSED FRAME

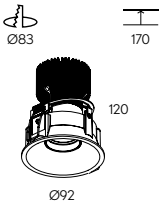
MARTORELL TARREGA	REF.	DIMENSIONS	FINISHES	LAMP	OPTIC OPTIONS	POWER	CRI	K	LUMEN	WATT	mA	DIMM	SKETCH
	20117	.01	●	LED	.25 .30	.ST	.9	.27 .30 .40	563 647 719	10	500	.DA .PU .D1	

Reference order | 20117.01.RF.XX.XX.ST9.XX.XX

Select finishes

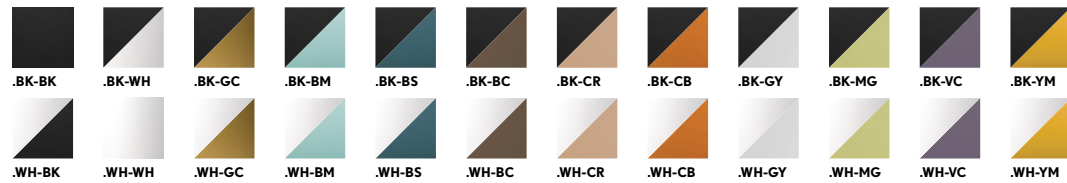

FINISHES

EXTERNAL COLOR



INTERNAL COLOR



DIMENSIONS

View in family specifications

.01

LIGHTING OPTIONS

BEAM ANGLE

25° | 38°

POWER

STANDARD

CRI

90

COLOR TEMPERATURE

2700K | 3000K | 4000K

DIMMABLE OPTIONS

DALI | 1.10 | PUSH

LIGHT DISTRIBUTION

DOWN

ON DEMAND

Dim to Warm
Tunable White
Wireless Control Options



INSTALLATIONS

.RF
RECESSED FRAME

·20117 TARREGA | RF
Pag. 498

.TR
TRIMLESS

·20117 TARREGA | TR
Pag. 678

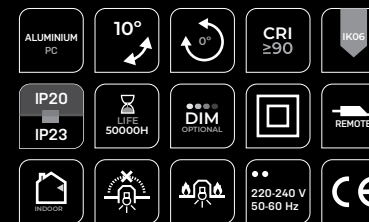

PHOTOMETRY

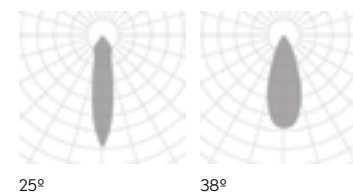

MARTORELL TARREGA

REF 20117.RF



RECESSED FRAME .RF

MARTORELL TARREGA SQ	REF.	DIMENSIONS	FINISHES	LAMP	OPTIC OPTIONS	POWER	CRI	K	LUMEN	WATT	mA	DIMM	SKETCH
	20116	.01	●	LED	.25 .30	.ST	.9	.27	563	10	500	.DA .PU .D1	
								.30	647				
								.40	719				

Reference order 20116.01.RF.XX.XX.ST9.XX.XX

MARTORELL TARREGA SQ2	REF.	DIMENSIONS	FINISHES	LAMP	OPTIC OPTIONS	POWER	CRI	K	LUMEN	WATT	mA	DIMM	SKETCH
	20119	.01	●	LED	.25 .30	.ST	.9	.27	1126	20	500	.DA .PU .D1	
								.30	1294				
								.40	1438				

Reference order 20119.01.RF.XX.XX.ST9.XX.XX

Select finishes

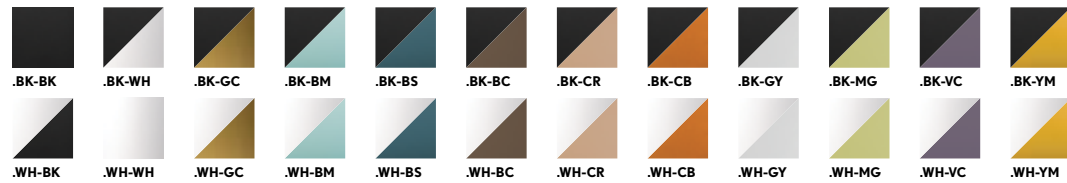

FINISHES

EXTERNAL COLOR



INTERNAL COLOR



DIMENSIONS

View in family specifications

.01

LIGHTING OPTIONS

BEAM ANGLE

25° | 30°

POWER

STANDARD

CRI

90

COLOR TEMPERATURE

2700K | 3000K | 4000K

DIMMABLE OPTIONS

DALI | 1.10 | PUSH

LIGHT DISTRIBUTION

DOWN

ON DEMAND

Dim to Warm
Tunable White
Wireless Control Options



INSTALLATIONS

.RF
RECESSED FRAME

·20116 TARREGA SQ | RF ·20119 TARREGA SQ2 | RF
Pag. 500

.TR
TRIMLESS

·20116 TARREGA SQ | TR
Pag. 678

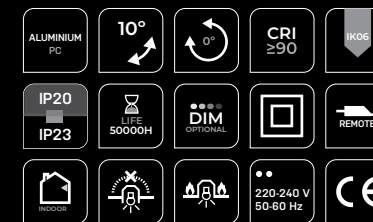

PHOTOMETRY

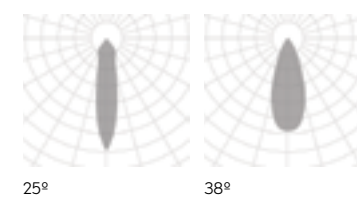





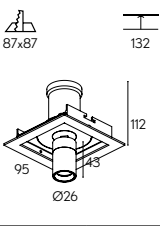

MARTORELL TARREGA SQ | TARREGA SQ2

20116.RF | 20119.RF

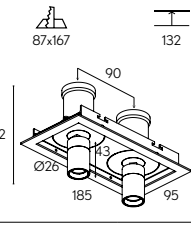

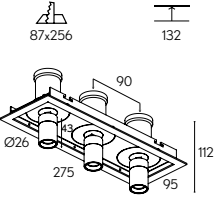
.RF
RECESSED FRAME

MARTORELL MINI CRATE	REF.	DIMEN- SIONS	FINISHES	LAMP	OPTIC OPTIONS	POWER	CRI	K	LUMEN	WATT	mA	DIMM	SKETCH
	20175	.01	●	LED	.9 .16 .30	.ST	.9	.27	175	3	700	.DA*1 .PU*1 .D1*1	
								.30	188				
								.40	199				
	20175	.02	●	LED	.20 .40 .60	.ST	.9	.27	350	6	700	.DA .PU .D1	
								.30	276				
								.40	398				
	20175	.03	●	LED	.20 .40 .60	.ST	.9	.27	525	9	700	.DA .PU .D1	
								.30	564				
								.40	597				

Reference order |  20175.XX.RF.XX.XX.ST.9.XX.XX

● Select external - internal finishes

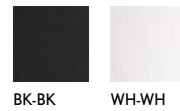

*1 Dimming options require the combination of a minimum of 2 luminaires. Las opciones de regulación necesitan la combinación de un mínimo de 2 luminarias.

FINISHES

COLOR



DIMENSIONS

● View in family specifications

.01 | .02 | .03

LIGHTING OPTIONS

■ BEAM ANGLE

9° | 16° | 20° | 30° | 40° | 60°

POWER

STANDARD

CRI

90

COLOR TEMPERATURE

2700K | 3000K | 4000K

▼ DIMMABLE OPTIONS

DALI | 1.10 | PUSH

▲ LIGHT DISTRIBUTION

DOWN

ON DEMAND

Wireless Control Options

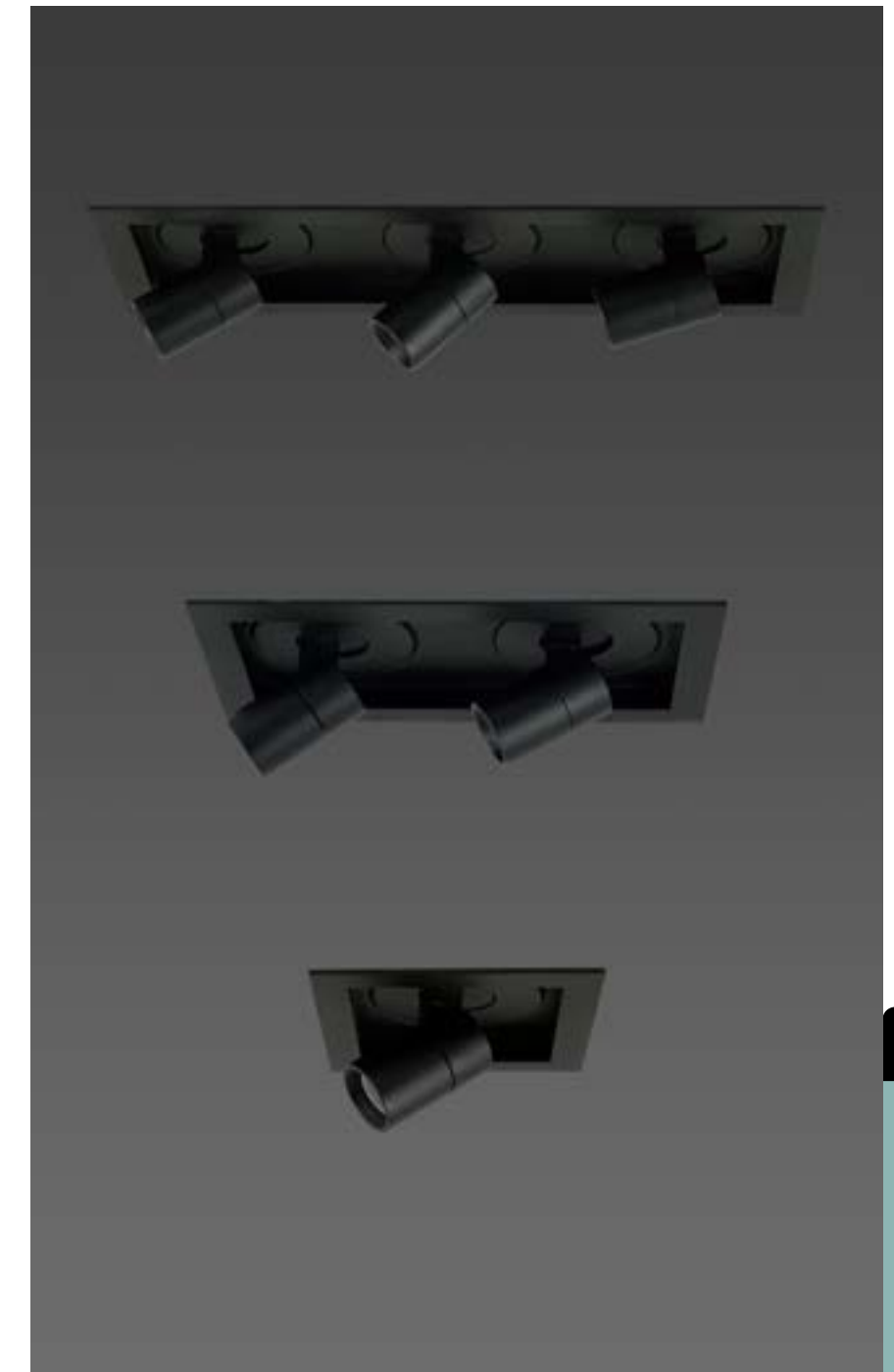

.RF
RECESSED FRAME

INSTALLATIONS

.SR
SURFACE

·20175 MARTORELL MINI CRATE | SR
Pag. 328

.RF
RECESSED FRAME

·20175 MARTORELL MINI CRATE | RF
Pag. 502





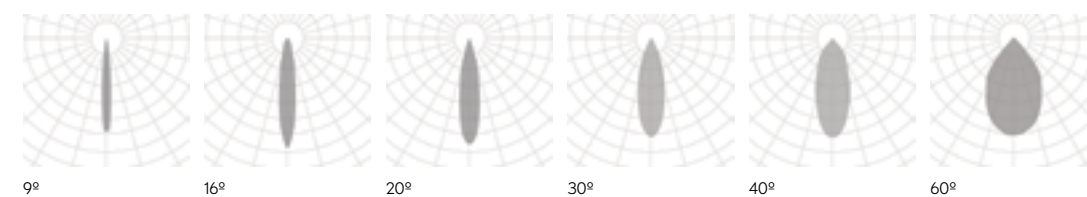

PHOTOMETRY

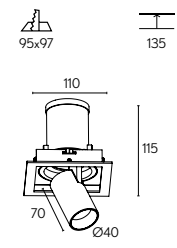

MARTORELL MINI CRATE

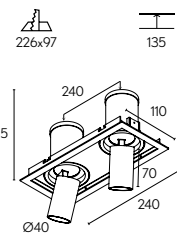
REF 20175.RF

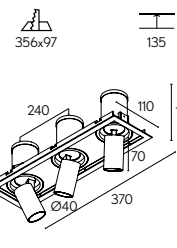
MARTORELL CRATE	REF.	DIMENSIONS	FINISHES	LAMP	OPTIC OPTIONS	POWER	CRI	K	LUMEN	WATT	mA	DIMM	SKETCH
	20176	.01	●	LED	.15 .24 .32	.ST	.9	.27 .30 .40	470 498 515	8	700	.DA .PU .D1	
	20176	.02	●	LED	.15 .24 .32	.ST	.9	.27 .30 .40	940 996 1030	16	700	.DA .PU .D1	
	20176	.03	●	LED	.15 .24 .32	.ST	.9	.27 .30 .40	1410 1494 1545	24	700	.DA .PU .D1	

Reference order | 20176.XX.RF.XX.XX.ST9.XX.XX

Select finishes

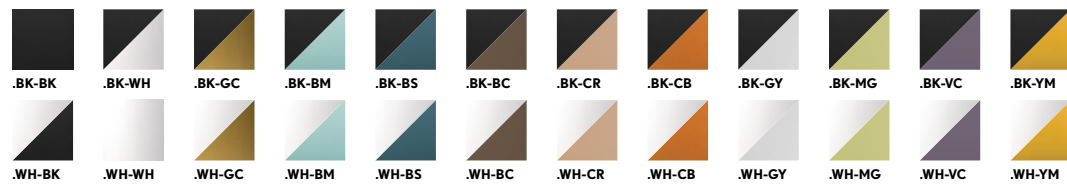

FINISHES

EXTERNAL COLOR



INTERNAL COLOR



DIMENSIONS

View in family specifications

.01 | .02 | .03

LIGHTING OPTIONS

BEAM ANGLE

15° | 24° | 32°

POWER

STANDARD

CRI

90

COLOR TEMPERATURE

2700K | 3000K | 4000K

DIMMABLE OPTIONS

DALI | 1.10 | PUSH

LIGHT DISTRIBUTION

DOWN

ON DEMAND

Dim to Warm
Tunable White
Wireless Control Options



.RF

RECESSED FRAME

INSTALLATIONS

.SR
SURFACE

·20176 MARTORELL CRATE | RF
Pag. 330

.RF
RECESSED FRAME

·20176 MARTORELL CRATE | RF
Pag. 504



PHOTOMETRY

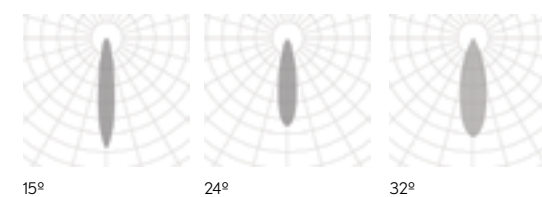

MARTORELL CRATE

REF 20176.RF

new

FACETUBULAR	REF.	DIMENSIONS	FINISHES	LAMP	OPTIC OPTIONS	POWER	CRI	K	LUMEN	WATT	mA	DIMM	SKETCH
	20205	.01	●	.LED	.40	.ST	.9	.27	480	8	350	.DA .PU .D1	
								.30	493				
								.40	496				

Reference order | 20205.01.RF.XX.XX.ST9.XX.XX

● Select external-internal finishes



FINISHES

COLORS



DIMENSIONS

● View in family specifications

.01

LIGHTING OPTIONS

■ BEAM ANGLE

40°

POWER

STANDARD

CRI

90

COLOR TEMPERATURE

2700K | 3000K | 4000K

▼ DIMMABLE OPTIONS

DALI | 1.10 | PUSH

▲ LIGHT DISTRIBUTION

DOWN

ON DEMAND

Wireless Control Options
Special RAL Color



INSTALLATIONS

.SR
SURFACE

·20205 FACE TUBULAR | SR
Pag. 360

.RF
RECESSED FRAME

·20205 FACE TUBULAR | RF
Pag. 506

- ALUMINIUM PC
- 90°
- 350°
- CRI ≥ 90
- IK05
- IP20 / IP23
- LIFE 50000H
- DIM OPTIONAL
- REMOTE
- RECOOR
- RECOOR
- RECOOR
- 220-240 V 50-60 Hz
- CE

PHOTOMETRY

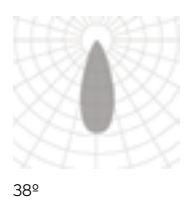

38°



FACE TUBULAR

REF 20205.RF

RECESSED FRAME .RF

KLIMT	REF.	DIMEN- SIONS	FINISHES	LAMP	OPTIC OPTIONS	POWER	CRI	K	LUMEN	WATT	mA	DIMM*1	SKETCH
	20134	.01	●	LED	.15 .24 .38	.ST	.9	.27	395	8	700	.DA .PU .D1	
								.30	497				
								.40	550				
	20134	.02	●	LED	.15 .24 .38 .60	.ST	.9	.27	803	11	500	.DA .PU .D1	
								.30	983				
								.40	991				
	20134	.03	●	LED	.15 .24 .38 .60	.ST	.9	.27	1945	30	700	.DA .PU .D1	
								.30	2073				
								.40	2311				

Reference order | 20134.XX.RF.XX.XX.ST9.XX.XX

● Select external - internal finishes

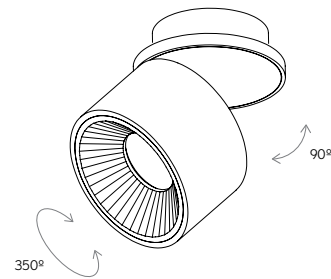

*1 Remote driver when dimable. Driver remoto cuando es dimable.

FINISHES

EXTERNAL COLOR



INTERNAL COLOR



DIMENSIONS

● View in family specifications

.01 | .02 | .03

LIGHTING OPTIONS

■ BEAM ANGLE

15° | 24° | 38° | 60°

POWER

STANDARD

CRI

90

COLOR TEMPERATURE

2700K | 3000K | 4000K

▼ DIMMABLE OPTIONS

DALI | 1.10 | PUSH

▲ LIGHT DISTRIBUTION

DOWN

ON DEMAND

Dim to Warm
Tunable White
Wireless Control Options
Special RAL Color



RECESSED FRAME

INSTALLATIONS

.SR
SURFACE

·20134 KLIMT | SR
Pag. 338

.TK
TRACKLIGHT

·20134 KLIMT | TK
Pag. 748

.RF
RECESSED FRAME

·20134 KLIMT | RF
Pag. 508

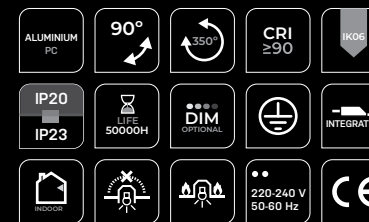



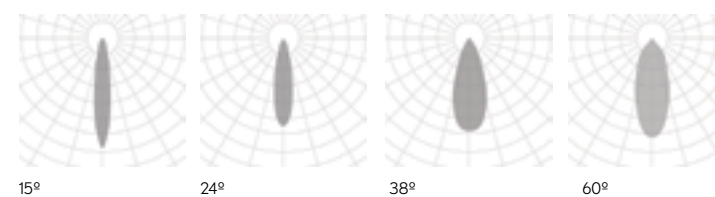

PHOTOMETRY

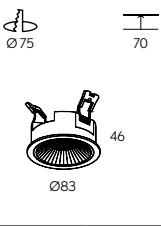

KLIMT

REF 20134.RF

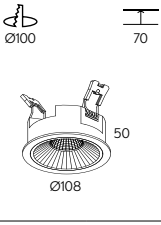
new

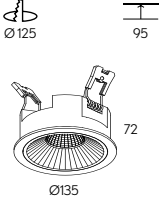
KLIMT FIX	REF.	DIMEN-SIONS	FINISHES	LAMP	OPTIC OPTIONS	POWER	CRI	K	LUMEN	WATT	mA	DIMM	SKETCH
	20135	.01	●	LED	.15 .24 .38	.ST	.9	.27	395	8	700	.DA .PU .D1	
								.30	497				
								.40	550				
	20135	.02	●	LED	.15 .25 .38 .60	.ST	.9	.27	803	11	500	.DA .PU .D1	
								.30	983				
								.40	991				
	20135	.03	●	LED	.15 .28 .40 .60	.ST	.9	.27	1945	30	700	.DA .PU .D1	
								.30	2073				
								.40	2311				

Reference order | 20135.XX.RF.XX.XX.ST9.XX.XX

• Select external - internal finishes



FINISHES

EXTERNAL | INTERNAL COLOR



INTERNAL COLOR



DIMENSIONS

• View in family specifications

.01 | .02 | .03

LIGHTING OPTIONS

■ BEAM ANGLE

15° | 24° | 25° | 28° | 38° | 40° | 60°

POWER

STANDARD

CRI

90

COLOR TEMPERATURE

2700K | 3000K | 4000K

▼ DIMMABLE OPTIONS

DALI | 1.10 | PUSH

▲ LIGHT DISTRIBUTION

DOWN

ON DEMAND

Dim to Warm
Tunable White
Wireless Control Options
Special RAL Color



RECESSED FRAME

INSTALLATIONS

.SR
SURFACE

•20135 KLIMT FIX | SR
Pag. 340

.RF
RECESSED FRAME

•20135 KLIMT FIX | RF
Pag. 510



KLIMT FIX

REF 20135.RF

PHOTOMETRY

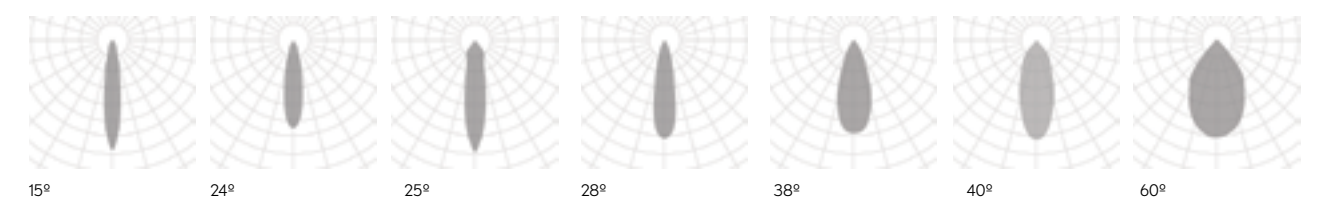

new

GEO	REF.	DIMENSIONS	FINISHES	OPTIC OPTIONS	POWER	CRI	K	LUMEN	WATT	mA	DIMM*1	SKETCH
	30511	.01	●	.15 .24 .38	.ST	.9	.27	498	8	700	.DA .PU .D1	
							.30	513				
							.40	622				
	30511	.02	●	.15 .25 .38 .60	.ST	.9	.27	1075	14	500	.DA .PU .D1	
							.30	1114				
							.40	1319				
	30511	.03	●	.15 .28 .40 .60	.ST	.9	.27	1856	30	700	.DA .PU .D1	
							.30	2031				
							.40	2529				

Reference order | 30511.XX.RF.XX.XX.ST9.XX.XX

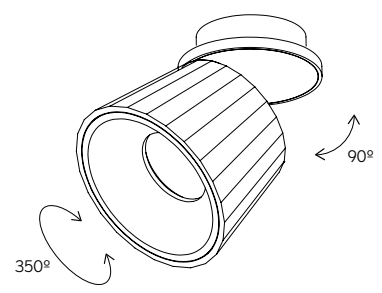

● Select external - internal finishes
 BK-BK WH-WH

*1 Remote driver when diable. Driver remoto cuando es dimable.

FINISHES

COLORS



DIMENSIONS

● View in family specifications

.01 | .02 | .03

LIGHTING OPTIONS

■ BEAM ANGLE

15° | 24° | 25° | 28° | 38° | 40° | 60°

POWER

STANDARD

CRI

90

COLOR TEMPERATURE

2700K | 3000K | 4000K

▼ DIMMABLE OPTIONS

DALI | 1.10 | PUSH

▲ LIGHT DISTRIBUTION

DOWN

ON DEMAND

Dim to Warm
 Tunable White
 Wireless Control Options
 Special RAL Color



RECESSED FRAME

INSTALLATIONS

- .SR SURFACE**
-30511 GEO|SR
Pag. 342
- .TK TRACKLIGHT**
-30511 GEO|TK
Pag. 750
- .RF RECESSED FRAME**
-30511 GEO|RF
Pag. 512

- ALUMINIUM PC
- 90°
- 350°
- CRI ≥ 90
- IK08
- IP20 / IP23
- LIFE 50000H
- DIM OPTIONAL
- INTEGRATED
- RECESSED
- 220-240 V 50-60 Hz
- CE

GEO

REF 30511.RF

PHOTOMETRY

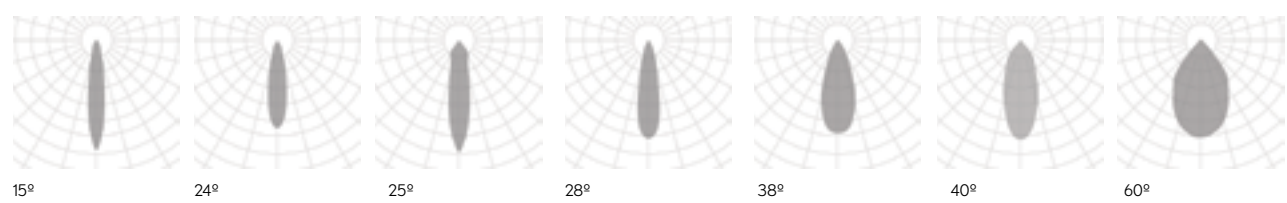

LUK FREIR	REF.	DIMENSIONS	FINISHES	LAMP	OPTIC OPTIONS	POWER	CRI	K	LUMEN	WATT	mA	DIMM	SKETCH
	20018	.01	●	.LED	.40 .60	.ST	.9	.27	830	9	350	.DA .PU .D1	
								.30	845				
								.40	895				
	20018	.02	●	.LED	.40 .60	.ST	.9	.27	1271	16	500	.DA .PU .D1	
								.30	1616				
								.40	1682				

Reference order | 20018XX.RF.XX.XX.ST9.XX.XX

LUK FREIR 2	REF.	DIMENSIONS	FINISHES	LAMP	OPTIC OPTIONS	POWER	CRI	K	LUMEN	WATT	mA	DIMM	SKETCH
	20019	.01	●	.LED	.40 .60	.ST	.9	.27	1660	18	350	.DA .PU .D1	
								.30	1690				
								.40	1790				
	20019	.02	●	.LED	.40 .60	.ST	.9	.27	2542	32	500	.DA .PU .D1	
								.30	3232				
								.40	3364				

Reference order | 20019.XX.RF.XX.XX.ST9.XX.XX

• Select finishes

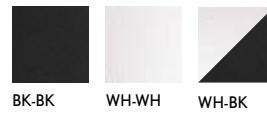

FINISHES

COLORS



DIMENSIONS

• View in family specifications

.01 | .02

LIGHTING OPTIONS

■ BEAM ANGLE

40° | 60°

POWER

STANDARD

CRI

90

COLOR TEMPERATURE

2700K | 3000K | 4000K

▼ DIMMABLE OPTIONS

DALI | 1.10 | PUSH

▲ LIGHT DISTRIBUTION

DOWN

ON DEMAND

Dim to Warm
Tunable White
Wireless Control Options

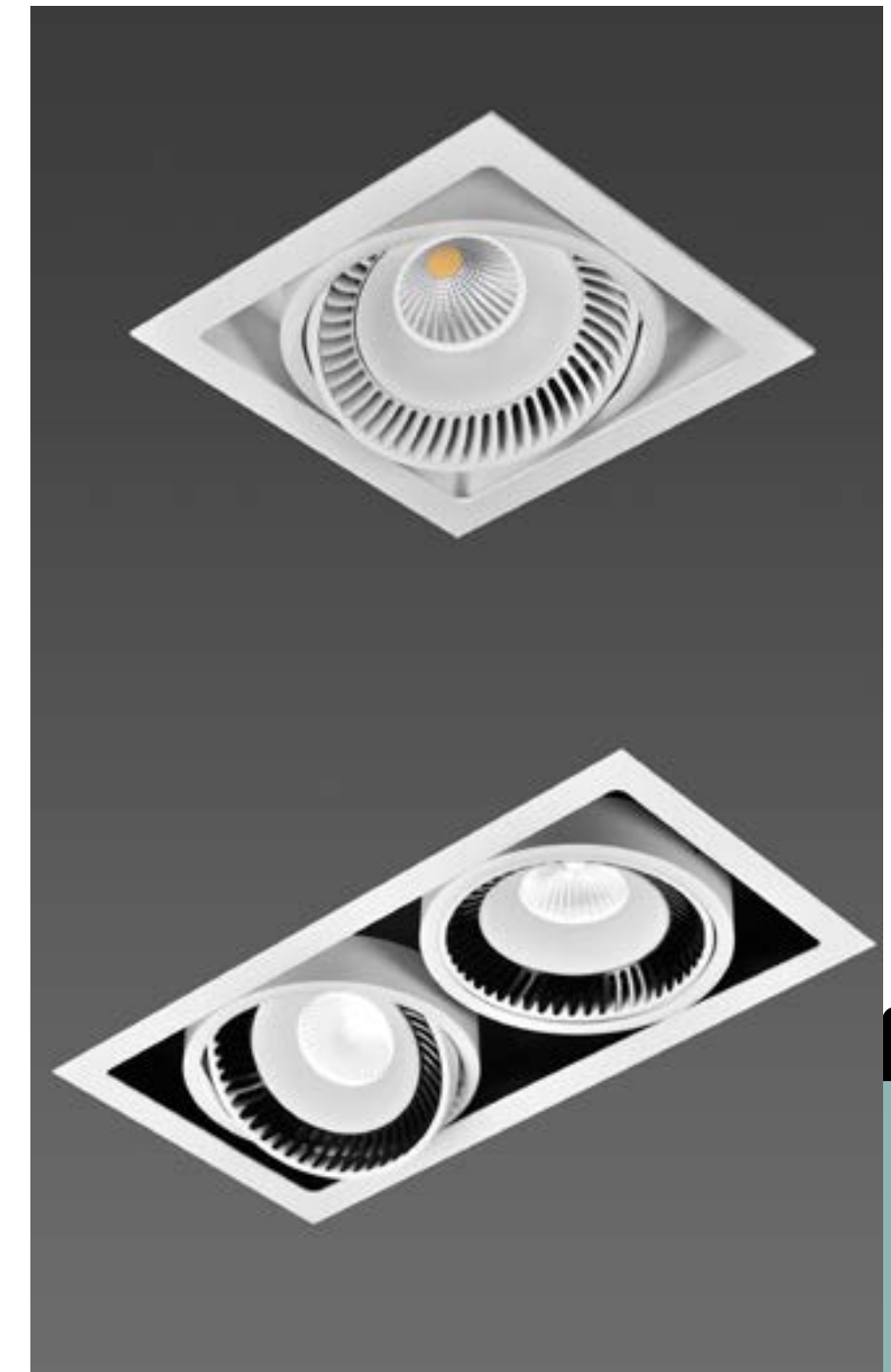

.RF

RECESSED FRAME

INSTALLATIONS

.SR
SURFACE

·20018 LUK FREIR ·20019 LUK FREIR 2 | SR
Pag. 344

.RF
RECESSED FRAME

·20018 LUK FREIR ·20019 LUK FREIR 2 | RF
Pag. 514

.TR
TRIMLESS

·20018 LUK FREIR ·20019 LUK FREIR 2 | TR
Pag. 680



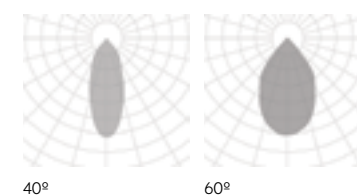

PHOTOMETRY



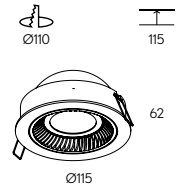

LUK
FREIR | FREIR 2

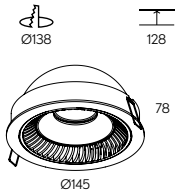
REF 20018.RF | REF 20019.RF

LUK	REF.	DIMENSIONS	FINISHES	LAMP	OPTIC OPTIONS	POWER	CRI	K	LUMEN	WATT	mA	DIMM	SKETCH
	20028	.01	●	.LED	.40 .60	.ST	.9	.27	787	14	350	.DA .PU .D1	
								.30	829				
								.40	876				
	20028	.02	●	.LED	.40 .60	.ST	.9	.27	1373	16	500	.DA .PU .D1	
								.30	1445				
								.40	1522				

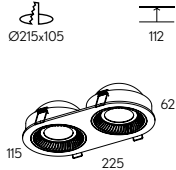
Reference order | 20028.XX.RF.XX.XX.ST9.XX.XX

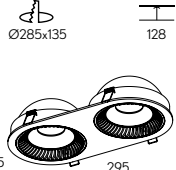
LUK 2	REF.	DIMENSIONS	FINISHES	LAMP	OPTIC OPTIONS	POWER	CRI	K	LUMEN	WATT	mA	DIMM	SKETCH
	20071	.01	●	.LED	.40 .60	.ST	.9	.27	1574	22	350	.DA .PU .D1	
								.30	1658				
								.40	1752				
	20071	.02	●	.LED	.40 .60	.ST	.9	.27	2746	39	500	.DA .PU .D1	
								.30	2890				
								.40	3040				

Reference order | 20071.XX.RF.XX.XX.ST9.XX.XX

• Select finishes

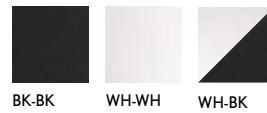

FINISHES

COLORS



DIMENSIONS

• View in family specifications

.01 | .02

LIGHTING OPTIONS

■ BEAM ANGLE

40° | 60°

POWER

STANDARD

CRI

90

COLOR TEMPERATURE

2700K | 3000K | 4000K

▼ DIMMABLE OPTIONS

DALI | 1.10 | PUSH

▲ LIGHT DISTRIBUTION

DOWN

ON DEMAND

Dim to Warm
Tunable White
Wireless Control Options



.RF
RECESSED FRAME

INSTALLATIONS

.RF
RECESSED FRAME

·20028 LUK ·20071 LUK2 | RF
Pag. 516

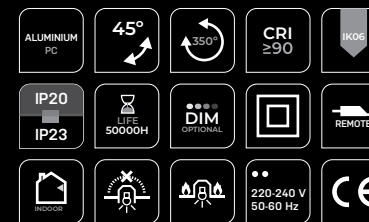

PHOTOMETRY

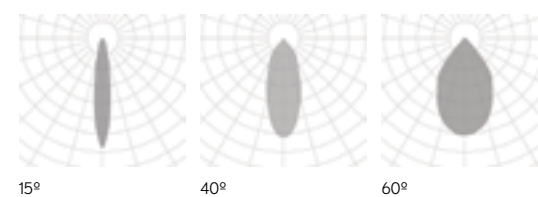

LUK
LUK | LUK 2

REF 20028.RF | REF 20071.RF

CUBESQ	REF.	DIMENSIONS	FINISHES	LAMP	OPTIC OPTIONS	POWER	CRI	K	LUMEN	WATT	mA	DIMM	SKETCH
	8201	.01	●	.LED	.24 .40 .60	.ST	.9	.27	738	11	350	.DA .PU .D1	
								.30	862				
								.40	929				

Reference order | 8201.01.RF.XX.XX.ST9.XX.XX

CUBESQ2	REF.	DIMENSIONS	FINISHES	LAMP	OPTIC OPTIONS	POWER	CRI	K	LUMEN	WATT	mA	DIMM	SKETCH
	8202	.01	●	.LED	.24 .40 .60	.ST	.9	.27	1476	22	350	.DA .PU .D1	
								.30	1724				
								.40	1858				

Reference order | 8202.01.RF.XX.XX.ST9.XX.XX

CUBESQ3	REF.	DIMENSIONS	FINISHES	LAMP	OPTIC OPTIONS	POWER	CRI	K	LUMEN	WATT	mA	DIMM	SKETCH
	8203	.01	●	.LED	.24 .40 .60	.ST	.9	.27	2214	33	350	.DA .PU .D1	
								.30	2586				
								.40	2787				

Reference order | 8203.01.RF.XX.XX.ST9.XX.XX

• Select finishes

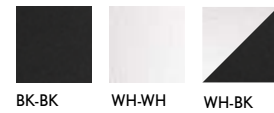

FINISHES

EXTERNAL COLOR



INTERNAL COLOR



DIMENSIONS

• View in family specifications

.01 | .02

LIGHTING OPTIONS

■ BEAM ANGLE

24° | 40° | 60°

POWER

STANDARD

CRI

90

COLOR TEMPERATURE

2700K | 3000K | 4000K

▼ DIMMABLE OPTIONS

DALI | 1.10 | PUSH

▲ LIGHT DISTRIBUTION

DOWN

ON DEMAND

Dim to Warm
Tunable White
Wireless Control Options



RECESSED FRAME

INSTALLATIONS

.SR
SURFACE

·8201 CUBE ·8202 CUBE 2 ·8203 CUBE 3 | SR
Pag. 354

.RF
RECESSED FRAME

·8201 CUBE ·8202 CUBE 2 ·8203 CUBE 3 | RF
Pag. 518

.TR
TRIMLESS

·8201 CUBE ·8202 CUBE 2 ·8203 CUBE 3 | TR
Pag. 682

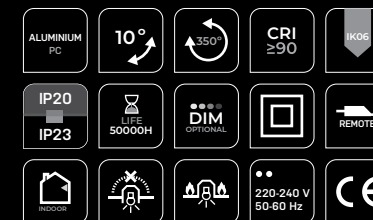

CUBE

SQ | SQ2 | SQ3

REF 8201.RF | REF 8202.RF | REF 8203.RF

PHOTOMETRY

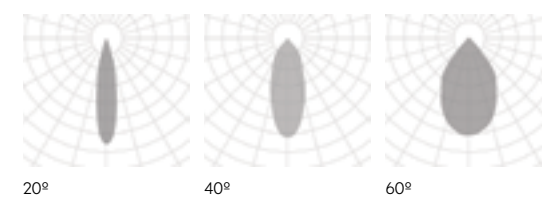

CUBESQ	REF.	DIMENSIONS	FINISHES	LAMP	OPTIC OPTIONS	POWER	CRI	K	LUMEN	WATT	mA	DIMM	SKETCH
	8201	.02	●	LED	.24 .40 .60	.ST	.9	.27	1661	19	500	.DA .PU .D1	
								.30	1819				
								.40	1837				

Reference order | 8201.02.RF.XX.XX.ST9.XX.XX

CUBESQ2	REF.	DIMENSIONS	FINISHES	LAMP	OPTIC OPTIONS	POWER	CRI	K	LUMEN	WATT	mA	DIMM	SKETCH
	8202	.02	●	LED	.24 .40 .60	.ST	.9	.27	3322	38	500	.DA .PU .D1	
								.30	3638				
								.40	3674				

Reference order | 8202.02.RF.XX.XX.ST9.XX.XX

CUBESQ3	REF.	DIMENSIONS	FINISHES	LAMP	OPTIC OPTIONS	POWER	CRI	K	LUMEN	WATT	mA	DIMM	SKETCH
	8203	.02	●	LED	.24 .40 .60	.ST	.9	.27	4983	58	500	.DA .PU .D1	
								.30	5457				
								.40	5511				

Reference order | 8203.02.RF.XX.XX.ST9.XX.XX

● Select finishes

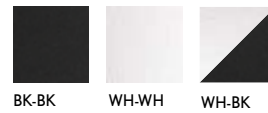

FINISHES

EXTERNAL COLOR



INTERNAL COLOR



DIMENSIONS

● View in family specifications

.01 | .02

LIGHTING OPTIONS

■ BEAM ANGLE

24° | 40° | 60°

POWER

STANDARD

CRI

90

COLOR TEMPERATURE

2700K | 3000K | 4000K

▼ DIMMABLE OPTIONS

DALI | 1.10 | PUSH

▲ LIGHT DISTRIBUTION

DOWN

ON DEMAND

Dim to Warm
Tunable White
Wireless Control Options



RECESSED FRAME

INSTALLATIONS

.SR
SURFACE

·8201 CUBE ·8202 CUBE 2 ·8203 CUBE 3 | SR
Pag. 354

.RF
RECESSED FRAME

·8201 CUBE ·8202 CUBE 2 ·8203 CUBE 3 | RF
Pag. 518

.TR
TRIMLESS

·8201 CUBE ·8202 CUBE 2 ·8203 CUBE 3 | TR
Pag. 682



CUBE SQ | SQ2 | SQ3

REF 8201.RF | REF 8202.RF | REF 8203.RF

PHOTOMETRY

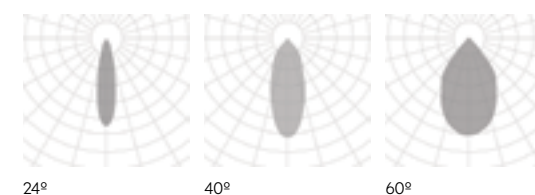

CUBESPOT	REF.	DIMEN-SIONS	FINISHES	LAMP	OPTIC OPTIONS	POWER	CRI	K	LUMEN	WATT	mA	DIMM	SKETCH
	3120	.01	●	.LED	.40 .60	.ST	.9	.27	845	12	250	.DA .PU .D1	
								.30	910				
								.40	975				

Reference order | 3120.01.RF.XX.XX.ST9.XX.XX

CUBESPOT 2	REF.	DIMEN-SIONS	FINISHES	LAMP	OPTIC OPTIONS	POWER	CRI	K	LUMEN	WATT	mA	DIMM	SKETCH
	3131	.01	●	.LED	.40 .60	.ST	.9	.27	1690	23	500	.DA .PU .D1	
								.30	1820				
								.40	1950				

Reference order | 3131.01.RF.XX.XX.ST9.XX.XX

● Select finishes



INSTALLATIONS

.RF
RECESSED FRAME

·3120 CUBE SPOT ·3131 CUBE SPOT 2 | RF
Pag. 522

FINISHES

COLORS



DIMENSIONS

● View in family specifications

.01

LIGHTING OPTIONS

■ BEAM ANGLE

40° | 60°

POWER

STANDARD

CRI

90

COLOR TEMPERATURE

2700K | 3000K | 4000K

▼ DIMMABLE OPTIONS

DALI | 1.10 | PUSH

▲ LIGHT DISTRIBUTION

DOWN

ON DEMAND

Dim to Warm
Tunable White
Wireless Control Options



RECESSED FRAME



CUBE SPOT | SPOT 2

REF 3120.RF | 3131.RF

PHOTOMETRY

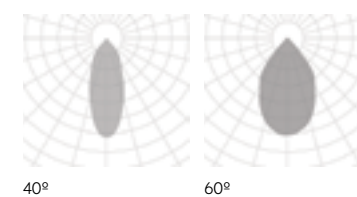

40°

60°

CUBE SPOT MOVE	REF.	DIMENSIONS	FINISHES	LAMP	OPTIC OPTIONS	POWER	CRI	K	LUMEN	WATT	mA	DIMM	SKETCH
	3121	.01	●	.LED	.40 .60	.ST	.9	.27	738	11	350	.DA .PU .D1	
								.30	862				
								.40	929				

Reference order | **3121.01.RF.XX.XX.ST.9.XX.XX**

CUBE SPOT 2 MOVE	REF.	DIMENSIONS	FINISHES	LAMP	OPTIC OPTIONS	POWER	CRI	K	LUMEN	WATT	mA	DIMM	SKETCH
	3136	.01	●	.LED	.40 .60	.ST	.9	.27	1476	22	350	.DA .PU .D1	
								.30	1724				
								.40	1858				

Reference order | **3136.01.RF.XX.XX.ST.9.XX.XX**

● Select finishes



BK-BK WH-WH

FINISHES

EXTERNAL | INTERNAL COLOR



DIMENSIONS

● View in family specifications

.01

LIGHTING OPTIONS

■ BEAM ANGLE

40° | 60°

POWER

STANDARD

CRI

90

COLOR TEMPERATURE

2700K | 3000K | 4000K

▼ DIMMABLE OPTIONS

DALI | 1.10 | PUSH

▲ LIGHT DISTRIBUTION

DOWN

ON DEMAND

Dim to Warm
Tunable White
Wireless Control Options



.RF

RECESSED FRAME

INSTALLATIONS

.RF
RECESSED FRAME

·3121 CUBE SPOT MOVE ·3136 CUBE SPOT MOVE 2 | RF
Pag. 524



CUBE SPOT MOVE | SPOT MOVE 2

REF 3121.RF | 3136.RF

PHOTOMETRY

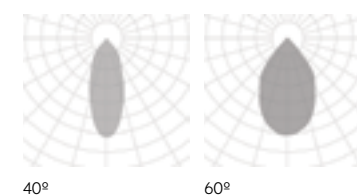

40°

60°

CUBE SPOT SQ MOVE	REF.	DIMENSIONS	FINISHES	LAMP	OPTIC OPTIONS	POWER	CRI	K	LUMEN	WATT	mA	DIMM	SKETCH
	3134	.01	●	.LED	.40 .60	.ST	.9	.27	738	11	350	.DA .PU .D1	
								.30	862				
								.40	929				

Reference order | 3134.01.RF.XX.XX.ST9.XX.XX

CUBE SPOT SQ 2 MOVE	REF.	DIMENSIONS	FINISHES	LAMP	OPTIC OPTIONS	POWER	CRI	K	LUMEN	WATT	mA	DIMM	SKETCH
	3135	.01	●	.LED	.40 .60	.ST	.9	.27	1476	22	350	.DA .PU .D1	
								.30	1724				
								.40	1858				

Reference order | 3135.01.RF.XX.XX.ST9.XX.XX

● Select finishes



*1 Please might expect a max 15% value reduction in finishes other than white. / Puede haber una reducción máx. del 15% en el dato de los acabados distintos al blanco.

FINISHES

COLORS



DIMENSIONS

● View in family specifications

.01

LIGHTING OPTIONS

■ BEAM ANGLE

40° | 60°

POWER

STANDARD

CRI

90

COLOR TEMPERATURE

2700K | 3000K | 4000K

▼ DIMMABLE OPTIONS

DALI | 1.10 | PUSH

▲ LIGHT DISTRIBUTION

DOWN

ON DEMAND

Dim to Warm
Tunable White
Wireless Control Options



.RF

RECESSED FRAME

INSTALLATIONS

.RF
RECESSED FRAME

·3134 CUBE SPOT SQ MOVE ·3135 CUBE SPOT SQ 2 MOVE | RF
Pag. 526



CUBE SPOT SQ MOVE | SPOT SQ 2 MOVE

REF 3134.RF | REF 3135.RF

PHOTOMETRY

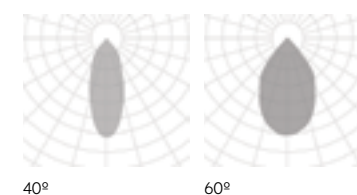

40°

60°

CAN REVIEW	REF.	DIMEN-SIONS	FINISHES	OPTIC OPTIONS	POWER	CRI	K	LUMEN	WATT	mA	DIMM	SKETCH
	20149	.01	●	.40 .60	.ST	.9	.27	823	10	500	.DA .PU .D1	
							.30	860				
							.40	910				
	20149	.02	●	.40 .60	.ST	.9	.27	1666	20	500	.DA .PU .D1	
							.30	1742				
							.40	1843				
	20149	.03	●	.40 .60	.ST	.9	.27	2456	30	750	.DA .PU .D1	
							.30	2568				
							.40	2718				
	20149	.04	●	.40 .60	.ST	.9	.27	3183	40	1000	.DA .PU .D1	
							.30	3327				
							.40	3520				
	20149	.05	●	.40 .60	.ST	.9	.27	4002	50	1200	.DA .PU .D1	
							.30	4184				
							.40	4427				

● Select external - internal finishes

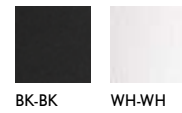

Reference order | 20149.XX.RF.XX.XX.ST.9.XX.XX

FINISHES

COLORS



DIMENSIONS

● View in family specifications

.01 | .02 | .03 | .04 | .05

LIGHTING OPTIONS

■ BEAM ANGLE

40° | 60°

POWER

STANDARD

CRI

90

COLOR TEMPERATURE

2700K | 3000K | 4000K

▼ DIMMABLE OPTIONS

DALI | 1.10 | PUSH

▲ LIGHT DISTRIBUTION

DOWN

ON DEMAND

Dim to Warm
Tunable White
Wireless Control Options



INSTALLATIONS

.RF
RECESSED FRAME

20149 CAN REVIEW | RF
Pag. 528



CAN REVIEW

REF 20149.RF

PHOTOMETRY

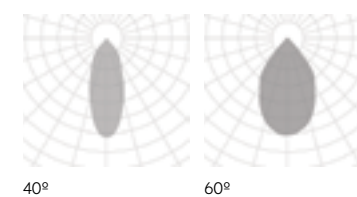

.RF
RECESSED FRAME

ALDAIA	REF.	DIMEN- SIONS	FINISHES	LAMP	DIFFUSER	POWER	CRI	K	LUMEN	WATT	mA	DIMM	SKETCH
	20157	.01	●	.LED	.OP	.ST	.9	.27	691	9	300	.DA .PU .D1	
								.30	727				
								.40	761				
	20157	.02	●	.LED	.OP	.ST	.9	.27	1227	16	500	.DA .PU .D1	
								.30	1292				
								.40	1309				
	20157	.03	●	.LED	.OP	.ST	.9	.27	2394	32	1050	.DA .PU .D1	
								.30	2520				
								.40	2678				

Reference order | 20157.XX.RF.XX.XX.ST9.XX.XX

● Select finishes

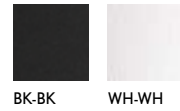

FINISHES

COLORS



DIMENSIONS

◆ View in family specifications

.01 | .02 | .03

LIGHTING OPTIONS

■ DIFFUSER

OPAL

POWER

STANDARD

CRI

90

COLOR TEMPERATURE

2700K | 3000K | 4000K

▼ DIMMABLE OPTIONS

DALI | 1.10 | PUSH

▲ LIGHT DISTRIBUTION

DOWN

ON DEMAND

Dim to Warm
Tunable White
Wireless Control Options



INSTALLATIONS

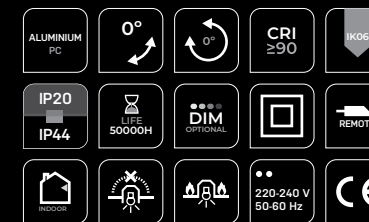

ALDAIA

REF 20157.RF

PHOTOMETRY

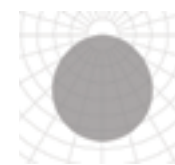

OPAL



.RF
RECESSED FRAME

·20157 ALDAIA | RF
Pag. 530

ALDAIA SQ	REF.	DIMEN-SIONS	FINISHES	LAMP	DIFFUSER	POWER	CRI	K	LUMEN	WATT	mA	DIMM	SKETCH
	20120	.01	●	.LED	.OP	.ST	.9	.27	691	9	300	.DA .PU .D1	
								.30	727				
								.40	761				
	20120	.02	●	.LED	.OP	.ST	.9	.27	1227	16	500	.DA .PU .D1	
								.30	1292				
								.40	1309				
	20120	.03	●	.LED	.OP	.ST	.9	.27	2394	32	1050	.DA .PU .D1	
								.30	2520				
								.40	2678				

Reference order | 20120.XX.RF.XX.XX.ST9.XX.XX

● Select finishes

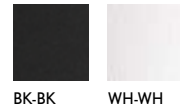

FINISHES

COLORS



DIMENSIONS

● View in family specifications

.01 | .02 | .03

LIGHTING OPTIONS

■ DIFFUSER

OPAL

POWER

STANDARD

CRI

90

COLOR TEMPERATURE

2700K | 3000K | 4000K

▼ DIMMABLE OPTIONS

DALI | 1.10 | PUSH

▲ LIGHT DISTRIBUTION

DOWN

ON DEMAND

Dim to Warm
Tunable White
Wireless Control Options



INSTALLATIONS

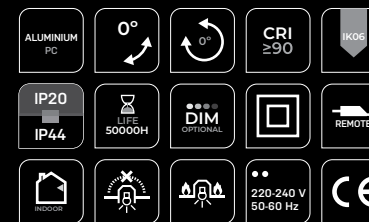

ALDAIA SQ

REF 20120.RF

PHOTOMETRY

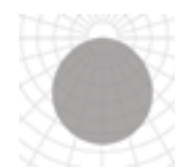

OPAL



.RF
RECESSED FRAME

·20120 ALDAIA SQ | RF
Pag. 532

RECESSED FRAME

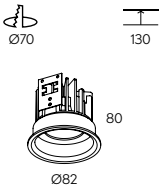
VADI	REF.	DIMENSIONS	FINISHES	LAMP	OPTIC OPTIONS	POWER	CRI	K	LUMEN	WATT	mA	DIMM	SKETCH
	3177	.01	.WH-WH	.LED	.40 .60	.ST	.9	.27 .30 .40	703 740 784	10	500	.DA .PU .D1	

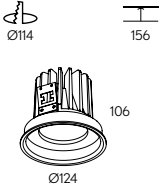
	3177	.02	.WH-WH	.LED	.40 .60	.ST	.9	.27 .30 .40	1373 1445 1522	16	500	.DA .PU .D1	
---	------	-----	--------	------	------------	-----	----	-------------------	----------------------	----	-----	-------------------	---

Reference order |  3177.XX.RFWH-WH.XX.ST9.XX.XX

FINISHES

COLORS



DIMENSIONS

View in family specifications

.01 | .02

LIGHTING OPTIONS

BEAM ANGLE

40° | 60°

POWER

STANDARD

CRI

90

COLOR TEMPERATURE

2700K | 3000K | 4000K

DIMMABLE OPTIONS

DALI | 1.10 | PUSH

LIGHT DISTRIBUTION

DOWN

ON DEMAND

Dim to Warm
Tunable White
Wireless Control Options



INSTALLATIONS

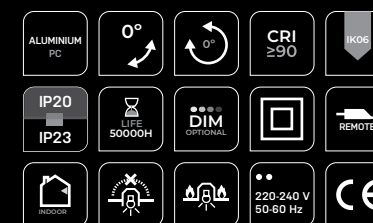

VADI

REF 3177.RF

.RF
RECESSED FRAME

·3177 VADI | RF
Pag. 534

PHOTOMETRY

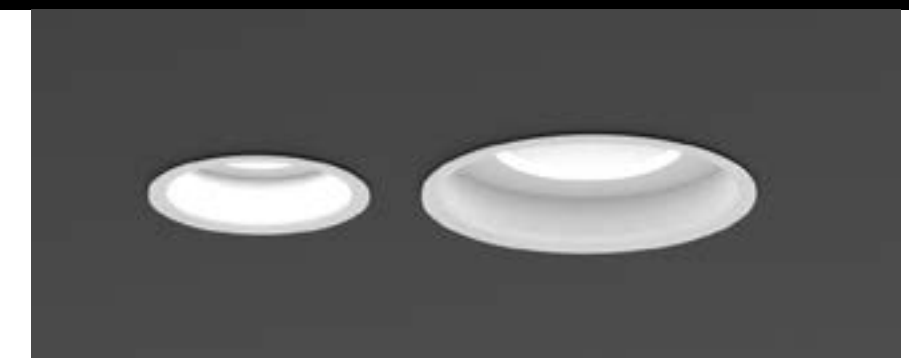
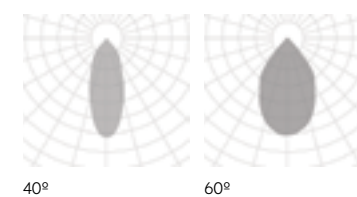

RECESSED FRAME

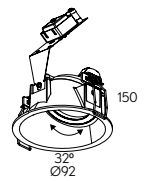
CASTEJON	REF.	DIMEN-SIONS	FINISHES	LAMP	OPTIC OPTIONS	POWER	CRI	K	LUMEN	WATT	mA	DIMM	SKETCH
	20074	.01	●	G5.3		GUS.3	-		526	Max 8	350	▼	
				GU10	.GU	GU10				Max 8			
				LED	.40 .60	.ST BPM50				.9			

Reference order |  20074.01.RF.XX.XX.XX.X.XX.XX

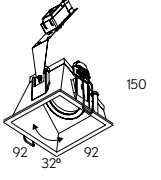
CASTEJONSQ	REF.	DIMEN-SIONS	FINISHES	LAMP	OPTIC OPTIONS	POWER	CRI	K	LUMEN	WATT	mA	DIMM	SKETCH
	20073	.01	●	G5.3		GUS.3	-		526	Max 8	350	▼	
				GU10	.GU	GU10				Max 8			
				LED	.40 .60	.ST BPM50				.9			

Reference order |  20073.01.RF.XX.XX.XX.X.XX.XX

● Select finishes



BK-BK WH-WH

FINISHES

COLORS



DIMENSIONS

View in family specifications

.01

LIGHTING OPTIONS

BEAM ANGLE / LAMP

40° | 60° | GU5.3 | GU10

POWER

STANDARD

CRI

90

COLOR TEMPERATURE

2700K | 3000K | 4000K

DIMMABLE OPTIONS

DALI | 1.10 | PUSH

LIGHT DISTRIBUTION

DOWN

ON DEMAND

Dim to Warm
Tunable White
Wireless Control Options



.RF
RECESSED FRAME

INSTALLATIONS

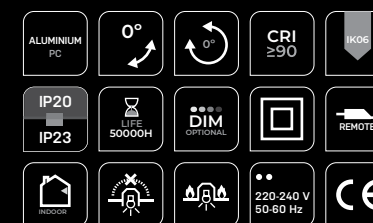

CASTEJON CASTEJON SQ

REF 20074.RF | REF 20073.RF

PHOTOMETRY

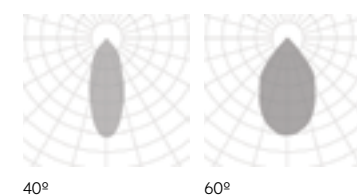

.RF
RECESSED FRAME

·20074 CASTEJON ·20073 CASTEJON SQ | RF
Pag. 536

ROY	REF.	DIMEN-SIONS	FINISHES	LAMP	OPTIC OPTIONS	POWER	CRI	K	LUMEN	WATT	mA	DIMM	SKETCH
	20154	.01	●	.LED	.18 .25 .38 .60	.ST	.9	.27 .30 .40	779 820 860	10	250	.DA .PU .D1	

Reference order | 20154.01.RF.XX.XX.ST9.XX.XX

• Select finishes

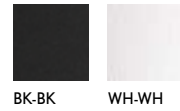

FINISHES

COLORS



DIMENSIONS

• View in family specifications

.01

LIGHTING OPTIONS

■ BEAM ANGLE

18° | 25° | 38° | 60°

POWER

STANDARD

CRI

90

COLOR TEMPERATURE

2700K | 3000K | 4000K

▼ DIMMABLE OPTIONS

DALI | 1.10 | PUSH

▲ LIGHT DISTRIBUTION

DOWN

ON DEMAND

Dim to Warm
Tunable White
Wireless Control Options



.RF
RECESSED FRAME

INSTALLATIONS

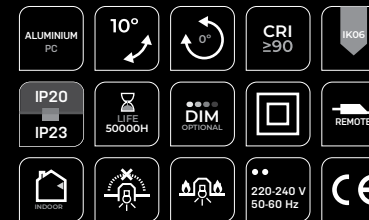

ROY

REF 20154.RF

.RF
RECESSED FRAME

20154 ROY | RF
Pag. 538

PHOTOMETRY

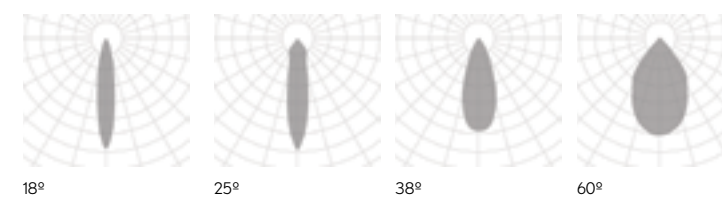

SU	REF.	DIMENSIONS	FINISHES	LAMP	OPTIC OPTIONS	POWER	CRI	K	LUMEN	WATT	mA	DIMM	SKETCH
	3149	.01	●	.LED	.60	.ST	.9	.27	260	5	350	.DA .PU .D1	
								.30	303				
								.40	544				
	3149	.02	●	.LED	.30	.ST	.9	.27	550	8	350	.DA .PU .D1	
								.30	639				
								.40	644				

Reference order | 3149.XX.RF.XX.XX.ST9.XX.XX

SUSQ	REF.	DIMENSIONS	FINISHES	LAMP	OPTIC OPTIONS	POWER	CRI	K	LUMEN	WATT	mA	DIMM	SKETCH
	3150	.01	●	.LED	.60	.ST	.9	.27	178	5	350	.DA .PU .D1	
								.30	187				
								.40	196				
	3150	.02	●	.LED	.32	.ST	.9	.27	513	7	350	.DA .PU .D1	
								.30	540				
								.40	570				

Reference order | 3150.XX.RF.XX.XX.ST9.XX.XX

• Select finishes



FINISHES

COLORS



DIMENSIONS

• View in family specifications

.01 | .02

LIGHTING OPTIONS

■ BEAM ANGLE

30° | 32° | 60°

POWER

STANDARD

CRI

90

COLOR TEMPERATURE

2700K | 3000K | 4000K

▼ DIMMABLE OPTIONS

DALI | 1.10 | PUSH

▲ LIGHT DISTRIBUTION

DOWN

ON DEMAND

Dim to Warm
Tunable White
Wireless Control Options

IP65

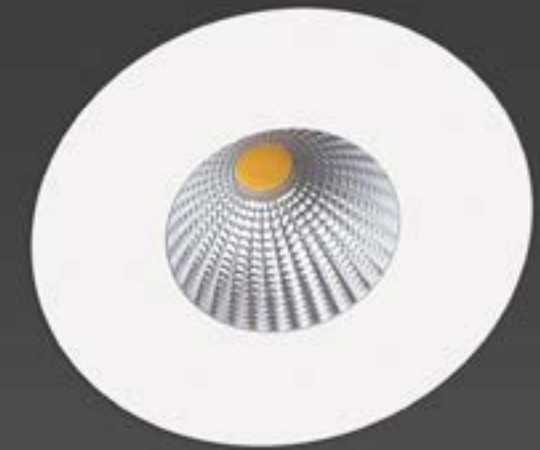

.RF

RECESSED FRAME

INSTALLATIONS

.RF
RECESSED FRAME

3149 SU 3150 SU SQ | RF
Pag. 540

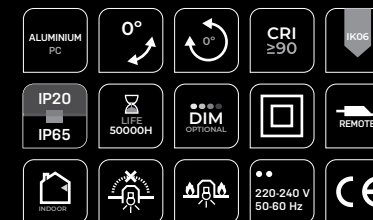

SU
SU SQ

REF 3149.RF | REF 3150.RF

PHOTOMETRY

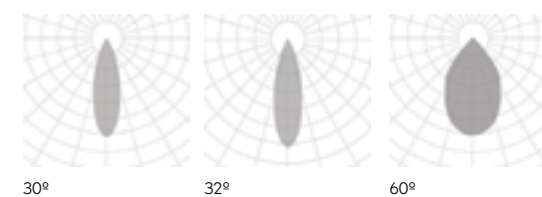

SU OTIS	REF.	DIMEN-SIONS	FINISHES	LAMP	OPTIC OPTIONS	POWER	CRI	K	LUMEN	WATT	mA	DIMM	SKETCH
	3234	.01	●	.LED	.24 .40 .60	.ST	.9	.27	578	10	500	.DA .PU .D1	
								.30	605				
								.40	663				
	3234	.02	●	.LED	.40	.ST	.9	.27	867	15	500	.DA .PU .D1	
								.30	908				
								.40	995				

Reference order 3234.XX.RF.XX.XX.ST.9.XX.XX

● Select finishes

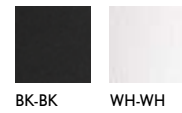

FINISHES

COLORS



DIMENSIONS

● View in family specifications

.01 | .02

LIGHTING OPTIONS

■ BEAM ANGLE

24° 40° 60° | 40°

POWER

STANDARD

CRI

90

COLOR TEMPERATURE

2700K | 3000K | 4000K

▼ DIMMABLE OPTIONS

DALI | 1.10 | PUSH

▲ LIGHT DISTRIBUTION

DOWN

ON DEMAND

Dim to Warm
Tunable White
Wireless Control Options



INSTALLATIONS



SU
OTIS

REF 3234.RF



.RF
RECESSED FRAME

3234 SU OTIS | RF
Pag. 542

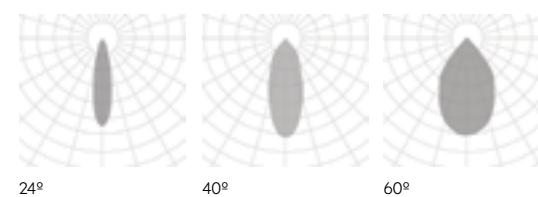

PHOTOMETRY

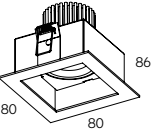

RECESSED FRAME

BASIT	REF.	DIMEN-SIONS	FINISHES	LAMP	OPTIC OPTIONS	POWER	CRI	K	LUMEN	WATT	mA	DIMM	SKETCH
	8012	.01	.WH-WH .BK-BK	G5.3		GUS.3				Max 8			
				GU10	.GU	GU10			Max 8				
				LED	.40 .60	.ST BPM50	.9	.27	526	8	350	.DA .PU .D1	
			.30	570									
			.40	711									

Reference order |  8012.01.RF.XX.XX.XX.X.XX.XX

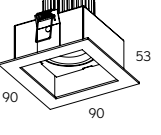
BASIT MOVE	REF.	DIMEN-SIONS	FINISHES	LAMP	OPTIC OPTIONS	POWER	CRI	K	LUMEN	WATT	mA	DIMM	SKETCH
	8013	.01	●	G5.3		GUS.3				Max 8			
				GU10	.GU	GU10			Max 8				
				LED	.40 .60	.ST BPM50	.9	.27	526	8	350	.DA .PU .D1	
			.30	570									
			.40	711									

Reference order |  8013.01.RF.XX.XX.XX.X.XX.XX

● Select finishes



FINISHES

COLORS



DIMENSIONS

View in family specifications

.01

LIGHTING OPTIONS

BEAM ANGLE / LAMP

40° | 60° | GU5.3 | GU10

POWER

STANDARD | HIGH

CRI

90

COLOR TEMPERATURE

2700K | 3000K | 4000K

DIMMABLE OPTIONS

DALI | 1.10 | PUSH

LIGHT DISTRIBUTION

DOWN

ON DEMAND

Dim to Warm
Tunable White
Wireless Control Options



.RF
RECESSED FRAME

INSTALLATIONS

.RF
RECESSED FRAME

·8012 BASIT ·8013 BASIT MOVE | RF
Pag. 544



PHOTOMETRY

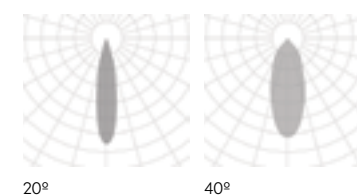

BASIT BASIT MOVE

REF 8012.RF | 8013.RF

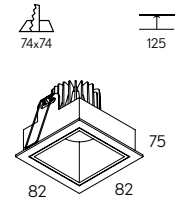
BASIT MONET	REF.	DIMEN-SIONS	FINISHES	LAMP	OPTIC OPTIONS	POWER	CRI	K	LUMEN	WATT	mA	DIMM	SKETCH
	20130	.01	●	.LED	.25 .38 .50	.ST	.9	.27	817	12	300	.DA .PU .D1	
								.30	854				
								.40	1002				

Reference order | 20130.01.RF.XX.XX.ST9.XX.XX

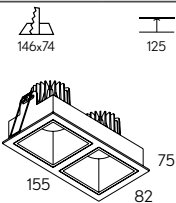
BASIT MONET 2	REF.	DIMEN-SIONS	FINISHES	LAMP	OPTIC OPTIONS	POWER	CRI	K	LUMEN	WATT	mA	DIMM	SKETCH
	20131	.01	●	.LED	.25 .38 .50	.ST	.9	.27	1633	25	300	.DA .PU .D1	
								.30	1707				
								.40	2005				

Reference order | 20131.01.RF.XX.XX.ST9.XX.XX

● Select finishes

BK-BK WH-WH WH-BK

- FINISHES

- COLORS
- DIMENSIONS

- View in family specifications

.01

- LIGHTING OPTIONS

- BEAM ANGLE

25° | 38° | 50°

- POWER

STANDARD

- CRI

90

- COLOR TEMPERATURE

2700K | 3000K | 4000K

- ▼ DIMMABLE OPTIONS

DALI | 1.10 | PUSH

- ▲ LIGHT DISTRIBUTION

DOWN

- ON DEMAND

Dim to Warm
Tunable White
Wireless Control Options

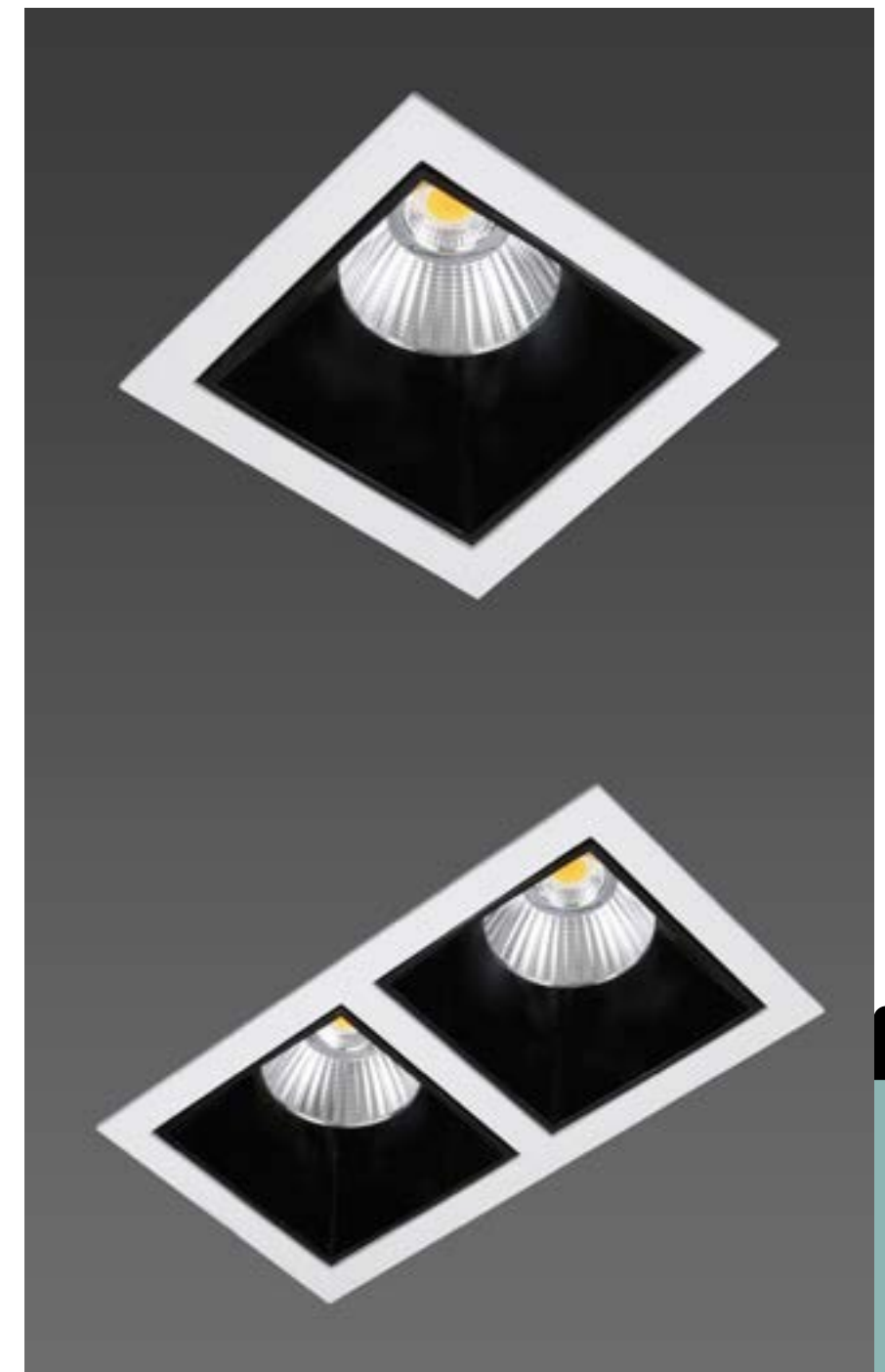

RECESSED FRAME

INSTALLATIONS

ALUMINIUM
PC

0°

0°

CRI
≥90

IK05

IP20
IP23

LIFE
50000H

DIM
OPTIONAL

REMOTE

RECESSED

220-240 V
50-60 Hz

CE

BASIT MONET | MONET 2





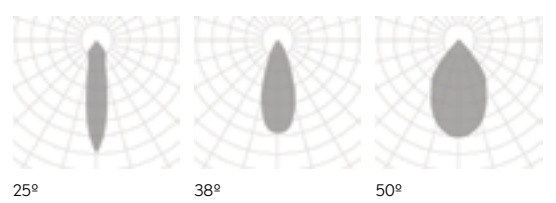

REF 20130.RF | REF 20131.RF

PHOTOMETRY



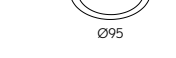



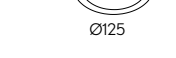

.RF
RECESSED FRAME

·20130 BASIT MONET ·20131 BASIT MONET 2 | RF
Pag. 546

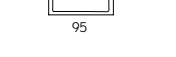
BASIT LLORENS	REF.	DIMEN-SIONS	FINISHES	LAMP	OPTIC OPTIONS	POWER	CRI	K	LUMEN	WATT	mA	DIMM	SKETCH
	20140	.01	.WH-WH	.LED	.24	.ST	.9	.27	370	9	300	.DA .PU .D1	
								.30	526				
								.40	607				
	20140	.02	.WH-WH	.LED	.24	.ST	.9	.27	370	12	300	.DA .PU .D1	
								.30	915				
								.40	907				

Reference order | 20140.XX.RFWH-WH.XX.ST9.XX.XX

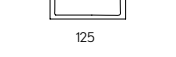
BASIT LLORENS SQ	REF.	DIMEN-SIONS	FINISHES	LAMP	OPTIC OPTIONS	POWER	CRI	K	LUMEN	WATT	mA	DIMM	SKETCH
	20144	.01	.WH-WH	.LED	.24	.ST	.9	.27	370	8	300	.DA .PU .D1	
								.30	526				
								.40	607				
	20144	.02	.WH-WH	.LED	.24	.ST	.9	.27	730	12	300	.DA .PU .D1	
								.30	915				
								.40	807				

Reference order | 20144.XX.RFWH-WH.XX.ST9.XX.XX

FINISHES

COLORS



DIMENSIONS

View in family specifications

.01 | .02

LIGHTING OPTIONS

BEAM ANGLE

24°

POWER

STANDARD

CRI

90

COLOR TEMPERATURE

2700K | 3000K | 4000K

DIMMABLE OPTIONS

DALI | 1.10 | PUSH

LIGHT DISTRIBUTION

DOWN

ON DEMAND

Dim to Warm
Tunable White
Wireless Control Options



.RF
RECESSED FRAME

INSTALLATIONS

.RF
RECESSED FRAME

·20140 BASIT LLORENS ·20144 BASIT LLORENS SQ | RF
Pag. 548



BASIT LLORENS | LLORENS SQ

REF 20140.RF | REF 20144.RF

PHOTOMETRY



24°

BASIT DERIN	REF.	DIMEN-SIONS	FINISHES	LAMP	OPTIC OPTIONS	POWER	CRI	K	LUMEN	WATT	mA	DIMM	SKETCH
	8010	.01	.WH-WH	GU5.3		GU5.3				Max 8			
				GU10	.GU	GU10				Max 8			

Reference order | 8010.01.RFWH-WH.XX.XX.X.XX.XX

FINISHES

COLORS



DIMENSIONS

View in family specifications

.01

LIGHTING OPTIONS

LAMP

GU5.3

GU10

POWER

CRI

COLOR TEMPERATURE

DIMMABLE OPTIONS

LIGHT DISTRIBUTION

DOWN



INSTALLATIONS



BASIT DERIN

REF 8010.RF

.RF
RECESSED FRAME

·8010 BASIT DERIN | RF
Pag. 550



.RF
RECESSED FRAME

KONI	REF.	DIMENSIONS	FINISHES	LAMP	OPTIC OPTIONS	POWER	CRI	K	LUMEN	WATT	mA	DIMM	SKETCH
	3161	.01	.WH-WH .BK-BK .GY-GY	GU5.3		GU5.3		-		Max 8			
				GU10	.GU	GU10			Max 8				
				LED	.40 .60	.ST BPM50	.9	.27 .30 .40	526 570 627	8	350	.DA .PU .D1	
	3161	.02	●	GU5.3		GU5.3		-		Max 8			
				GU10	.GU	GU10			Max 8				
				LED	.40 .60	.ST BPM50	.9	.27 .30 .40	526 570 627	8	350	.DA .PU .D1	
	3161	.03	.WH-WH .BK-BK	G53		G53		-		Max 20			
				GU10	.GU	GU10			Max 20				
				CDMR	.CD	G4.5			Max 20				

● Select finishes

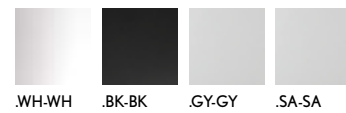

Reference order | 3161.XX.RF.XX.XX.XX.XX.XX.XX

FINISHES

EXTERNAL | INTERNAL COLOR



DIMENSIONS

View in family specifications

.01 | .02 | .03

LIGHTING OPTIONS

BEAM ANGLE / LAMP

40° | 60° | GU5.3 | GU10 | CDMR

POWER

STANDARD

CRI

90

COLOR TEMPERATURE

2700K | 3000K | 4000K

DIMMABLE OPTIONS

DALI | 1.10 | PUSH

LIGHT DISTRIBUTION

DOWN

ON DEMAND

Dim to Warm
Tunable White
Wireless Control Options



.RF
RECESSED FRAME

INSTALLATIONS

.RF
RECESSED FRAME

3161 KONI | RF
Pag. 552

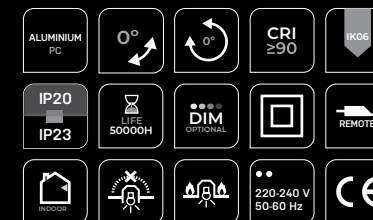

PHOTOMETRY

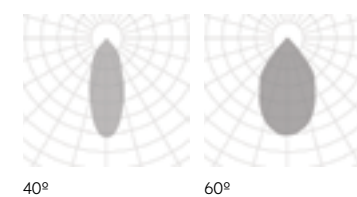

KONI

REF 3161.RF

new

KONISQ	REF.	DIMENSIONS	FINISHES	LAMP	OPTIC OPTIONS	POWER	CRI	K	LUMEN	WATT	mA	DIMM	SKETCH
	3169	.01	●	GU5.3		GU5.3				Max 8			
				GU10	.GU	GU10			Max 8				
				LED	.40 .60	.ST BPMSO	.9	.27 .30 .40	526 570 627	8	350		.DA .PU .D1

Reference order | **3169.01.RF.XX.XX.XX.X.XX.XX**

● Select finishes

BK-BK WH-WH

FINISHES

COLORS

DIMENSIONS

● View in family specifications

.01

LIGHTING OPTIONS

■ BEAM ANGLE / LAMP

40° | 60° | GU5.3 | GU10

POWER

STANDARD

CRI

90

COLOR TEMPERATURE

2700K | 3000K | 4000K

▼ DIMMABLE OPTIONS

DALI | 1.10 | PUSH

▲ LIGHT DISTRIBUTION

DOWN

ON DEMAND

Dim to Warm
Tunable White
Wireless Control Options



INSTALLATIONS

- ALUMINIUM PC
- 45°
- 0°
- CRI ≥90
- IP20
- IP23
- LIFE 50000H
- DIM OPTIONAL
- REMO
- RECESSED
- RECESSED
- 220-240 V 50-60 Hz
- CE

KONI SQ

REF 3169.RF

PHOTOMETRY

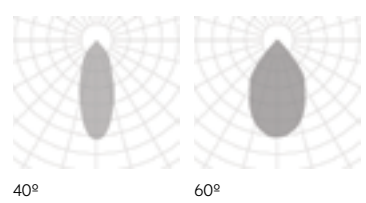

.RF
RECESSED FRAME

3169 KONISQ | RF
Pag. 554

RECESSED FRAME

new



KONIDEEP	REF.	DIMENSIONS	FINISHES	LAMP	OPTIC OPTIONS	POWER	CRI	K	LUMEN	WATT	mA	DIMM	SKETCH	
	3171	.01	●	GU5.3		GU5.3	-	-	526	Max 8	-	-		
				GU10	.GU	GU10				Max 8				LED 180
				LED	.40 .60	.ST BPMSO				.9				.27 .30 .40

Reference order | 3171.01.RF.XX.XX.ST9.XX.XX

● Select finishes



FINISHES

COLORS



DIMENSIONS

● View in family specifications

.01

LIGHTING OPTIONS

■ BEAM ANGLE / LAMP

40° | 60° | GU5.3 | GU10

POWER

STANDARD

CRI

90

COLOR TEMPERATURE

2700K | 3000K | 4000K

▼ DIMMABLE OPTIONS

DALI | 1.10 | PUSH

▲ LIGHT DISTRIBUTION

DOWN

ON DEMAND

Dim to Warm
Tunable White
Wireless Control Options



INSTALLATIONS

.RF
RECESSED FRAME

.3171 KONIDEEP | RF
Pag. 556



KONI DEEP

REF 3171.RF

PHOTOMETRY

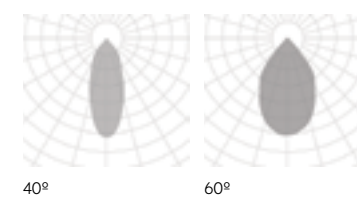

40°

60°

.RF

RECESSED FRAME

KONI TURTA	REF.	DIMEN-SIONS	FINISHES	LAMP	OPTIC OPTIONS	POWER	CRI	K	LUMEN	WATT	mA	DIMM	SKETCH
	3156	.01**	●	.LED	.40 .60	.ST	.9	.27	513	8	350	.DA .PU .D1	
								.30	540				
								.40	574				

	3156	.02	●	.LED	.40 .60	.ST	.9	.27	513	8	350	.DA .PU .D1	
								.30	540				
								.40	574				

Reference order | 3156.XX.RF.XX.XX.ST9.XX.XX

● Select finishes



** Model 3156.01 does not tilt or rotate. El modelo 3156.01 no bascula ni gira.

FINISHES

COLORS



DIMENSIONS

● View in family specifications

.01 | .02

LIGHTING OPTIONS

■ BEAM ANGLE

40° | 60°

POWER

STANDARD

CRI

90

COLOR TEMPERATURE

2700K | 3000K | 4000K

▼ DIMMABLE OPTIONS

DALI | 1.10 | PUSH

▲ LIGHT DISTRIBUTION

DOWN

ON DEMAND

Dim to Warm
Tunable White
Wireless Control Options



INSTALLATIONS



KONI TURTA

REF 3156.RF

.RF
RECESSED FRAME

3156 KONI TURTA | RF
Pag. 558

PHOTOMETRY

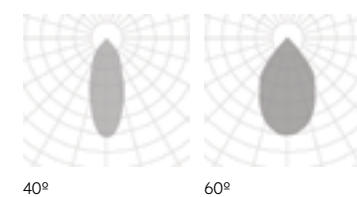

RECESSED FRAME

CATLI	REF.	DIMEN-SIONS	FINISHES	LAMP	OPTIC OPTIONS	POWER	CRI	K	LUMEN*1	WATT	mA	DIMM	SKETCH			
	3010	.01	●	GU5.3		GU5.3	.9		526	8	350	.DA .PU .D1				
				GU10	.GU	GU10										
				LED	.40 .60	.ST								BPM50	.27	526
															.30	570
															.40	627
															.27	707
															.30	730
															.40	767

CATLI	REF.	DIMEN-SIONS	FINISHES	LAMP	OPTIC OPTIONS	POWER	CRI	K	LUMEN*1	WATT	mA	DIMM	SKETCH			
	3010	.02	●	G53		G53	.9		1661	16	500	.DA .PU .D1				
				GU10	.GU	GU10										
				CDMR	.CD	GX8.5										
				LED	.40 .60	.ST								BPM3181	.27	1661
															.30	1819
															.40	1837

Reference order | 3010.XX.RF.XX.XX.XX.X.XX.XX

● Select internal - external finishes

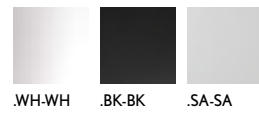

*1 Please might expect max. 15% value reduction in finishes other than white. / Puede haber una reducción máx. del 15% en el dato de los acabados al blanco.

FINISHES

COLORS



DIMENSIONS

View in family specifications

.01 | .02

LIGHTING OPTIONS

BEAM ANGLE / LAMP

40° | 60° | GU5.3 | GU10 | CDMR

POWER

STANDARD | HIGH

CRI

90

COLOR TEMPERATURE

2700K | 3000K | 4000K

DIMMABLE OPTIONS

DALI | 1.10 | PUSH

LIGHT DISTRIBUTION

DOWN

ON DEMAND

Dim to Warm
Tunable White
Wireless Control Options



INSTALLATIONS

.SR
SURFACE

.3010 CATLI | SR
Pag. 358

.RF
RECESSED FRAME

.3010 CATLI | RF
Pag. 560



PHOTOMETRY

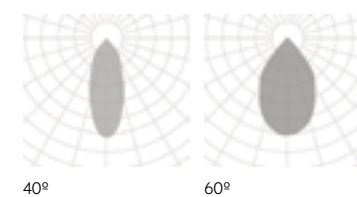

CATLI

REF 3010.RF

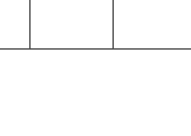

RECESSED FRAME

CATLISO	REF.	DIMENSIONS	FINISHES	LAMP	OPTIC OPTIONS	POWER	CRI	K	LUMEN	WATT	mA	DIMM	SKETCH					
	3011	.01	●	GU5.3		GU5.3	.9			Max 8		▼						
				GU10	.GU	GU10												
				LED	.40 .60	.ST BPM50								.27	526	8	350	.DA .PU .D1
														.30	570			
														.40	711			
														.27	707			
														.30	927			
														.40	767			

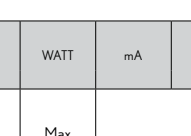
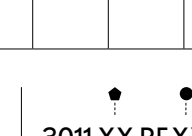
CATLISO	REF.	DIMENSIONS	FINISHES	LAMP	OPTIC OPTIONS	POWER	CRI	K	LUMEN	WATT	mA	DIMM	SKETCH					
	3011	.02	●	G53		G53	.9			Max 20		▼						
				GU10	.GU	GU10												
				CDMR	.CD	GX8.5												
				LED	.40 .60	.ST BPM3181								.27	1538	16	500	.DA .PU .D1
														.30	1722			
														.40	1355			

Reference order | 3011.XX.RF.XX.XX.XX.XX.XX.XX

● Select finishes

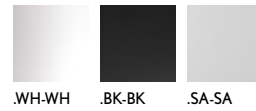

FINISHES

COLORS



DIMENSIONS

● View in family specifications

.01 | .02

LIGHTING OPTIONS

■ BEAM ANGLE / LAMP

40° | 60° | GU5.3 | GU10 | CDMR

POWER

STANDARD | HIGH

CRI

90

COLOR TEMPERATURE

2700K | 3000K | 4000K

▼ DIMMABLE OPTIONS

DALI | 1.10 | PUSH

▲ LIGHT DISTRIBUTION

DOWN

ON DEMAND

Dim to Warm
Tunable White
Wireless Control Options



INSTALLATIONS

.SR
SURFACE

·3011CATLISQ|SR
Pag. 362

.RF
RECESSED FRAME

·3011CATLISQ|RF
Pag. 562



PHOTOMETRY

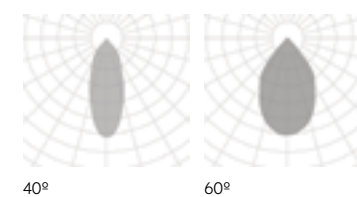

CATLI SQ

REF 3011.RF



RECESSED FRAME

CATLI SQ2	REF.	DIMENSIONS	FINISHES	LAMP	OPTIC OPTIONS	POWER	CRI	K	LUMEN	WATT	mA	DIMM	SKETCH									
	3012	.01	●	GU5.3	-	GU5.3	.9	-	-	Max 2x8	-	-										
				GU10		.GU								GU10	LED 67							
				LED	.40 .60	.ST								BPM50	.27	1052	16	350	25	186	.DA .PU .D1	
															.30	1140						
															.40	1422						
															.27	1414						
.HI	BPM300	.30	1854	20	500																	
		.40	1534																			

CATLI SQ2	REF.	DIMENSIONS	FINISHES	LAMP	OPTIC OPTIONS	POWER	CRI	K	LUMEN	WATT	mA	DIMM	SKETCH									
	3012	.02	●	G53	-	G53	.9	-	-	Max 2x20	-	-										
				GU10		.GU								GU10	LED 106							
				CDMR		.CD								GX8.5	GUICD 163							
				LED	.40 .60	.ST								BPM3181	.27	3076	32	500	25	170	.DA .PU .D1	
															.30	3444						
															.40	2710						

Reference order | **3012.XX.RF.XX.XX.XX.XXX.XXX.XX**

● Select finishes

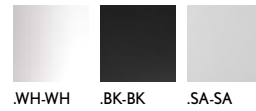

FINISHES

COLORS



DIMENSIONS

● View in family specifications

.01 | .02

LIGHTING OPTIONS

■ BEAM ANGLE / LAMP

40° | 60° | GU5.3 | GU10 | CDMR

POWER

STANDARD | HIGH

CRI

90

COLOR TEMPERATURE

2700K | 3000K | 4000K

▼ DIMMABLE OPTIONS

DALI | 1.10 | PUSH

▲ LIGHT DISTRIBUTION

DOWN

ON DEMAND

Dim to Warm
Tunable White
Wireless Control Options



INSTALLATIONS



CATLI SQ2

REF 3012.RF

.RF
RECESSED FRAME

·3012 CATLI SQ2 | RF
Pag. 564

PHOTOMETRY

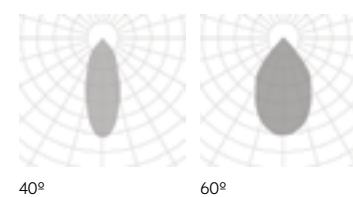

RECESSED FRAME

.RF

CATLI SQ3	REF.	DIMENSIONS	FINISHES	LAMP	OPTIC OPTIONS	POWER	CRI	K	LUMEN	WATT	mA	DIMM	SKETCH								
	3013	.01	●	GU5.3	-	GU5.3	.9	-	-	Max 3x8	-	-									
				GU10		.GU								GU10	LED 67						
				LED	.40 .60	.ST								BPM50	.27	1578	24	350	.DA .PU .D1		
																.30					1710
																.40					2133
																.27					2121
																.30					2781
																.40					2301

	3013	.02	●	G53	-	G53	.9	-	-	Max 3x20	-	-									
				GU10		.GU								GU10	LED 106						
				CDMR		.CD								GX8.5	GUICD 163						
				LED	.40 .60	.ST								BPM3181	.27	4,614	48	500	.DA .PU .D1		
																.30					5166
																.40					4,065

Reference order | 3013.XX.RF.XX.XX.XX.XX.XX.XX

● Select finishes

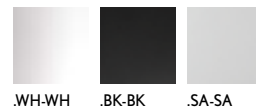

FINISHES

COLORS



DIMENSIONS

● View in family specifications

.01 | .02

LIGHTING OPTIONS

■ BEAM ANGLE / LAMP

40° | 60° | GU5.3 | GU10 | CDMR

POWER

STANDARD | HIGH

CRI

90

COLOR TEMPERATURE

2700K | 3000K | 4000K

▼ DIMMABLE OPTIONS

DALI | 1.10 | PUSH

▲ LIGHT DISTRIBUTION

DOWN

ON DEMAND

Dim to Warm
Tunable White
Wireless Control Options



INSTALLATIONS



CATLI SQ3

REF 3013.RF

.RF
RECESSED FRAME

·3013 CATLI SQ3 | RF
Pag. 566

PHOTOMETRY

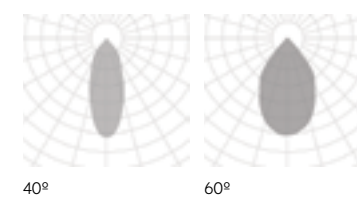

RECESSED FRAME

CATLI HALKA	REF.	DIMEN-SIONS	FINISHES	LAMP	OPTIC OPTIONS	POWER	CRI	K	LUMEN	WATT	mA	DIMM	SKETCH																
	3017	.01	●	GU5.3	■	GU5.3	9	.	526	Max 8	350	.DA .PU .D1																	
				GU10		.GU								GU10	Max 8														
				LED	.40 .60	.ST				■			BPM50	.9	.	570	711	8	350	500	.DA .PU .D1								
																							.HI	BPM300	.	707	10	500	.DA .PU .D1
																							.	767	10	500	.DA .PU .D1		

Reference order 3017.01.RF.XX.XX.XX.XX.XX.XX

CATLI HALKA SQ	REF.	DIMEN-SIONS	FINISHES	LAMP	OPTIC OPTIONS	POWER	CRI	K	LUMEN	WATT	mA	DIMM	SKETCH																
	3021	.01	●	GU5.3	■	GU5.3	9	.	526	Max 8	350	.DA .PU .D1																	
				GU10		.GU								GU10	Max 8														
				LED	.40 .60	.ST				■			BPM50	.9	.	570	711	8	350	500	.DA .PU .D1								
																							.HI	BPM300	.	707	10	500	.DA .PU .D1
																							.	767	10	500	.DA .PU .D1		

Reference order 3021.01.RF.XX.XX.XX.XX.XX.XX

● Select finishes

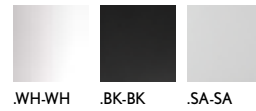

FINISHES

COLORS



DIMENSIONS

View in family specifications

.01

LIGHTING OPTIONS

BEAM ANGLE / LAMP

40° | 60° | GU5.3 | GU10

POWER

STANDARD | HIGH

CRI

90

COLOR TEMPERATURE

2700K | 3000K | 4000K

DIMMABLE OPTIONS

DALI | 1.10 | PUSH

LIGHT DISTRIBUTION

DOWN

ON DEMAND

Dim to Warm
Tunable White
Wireless Control Options

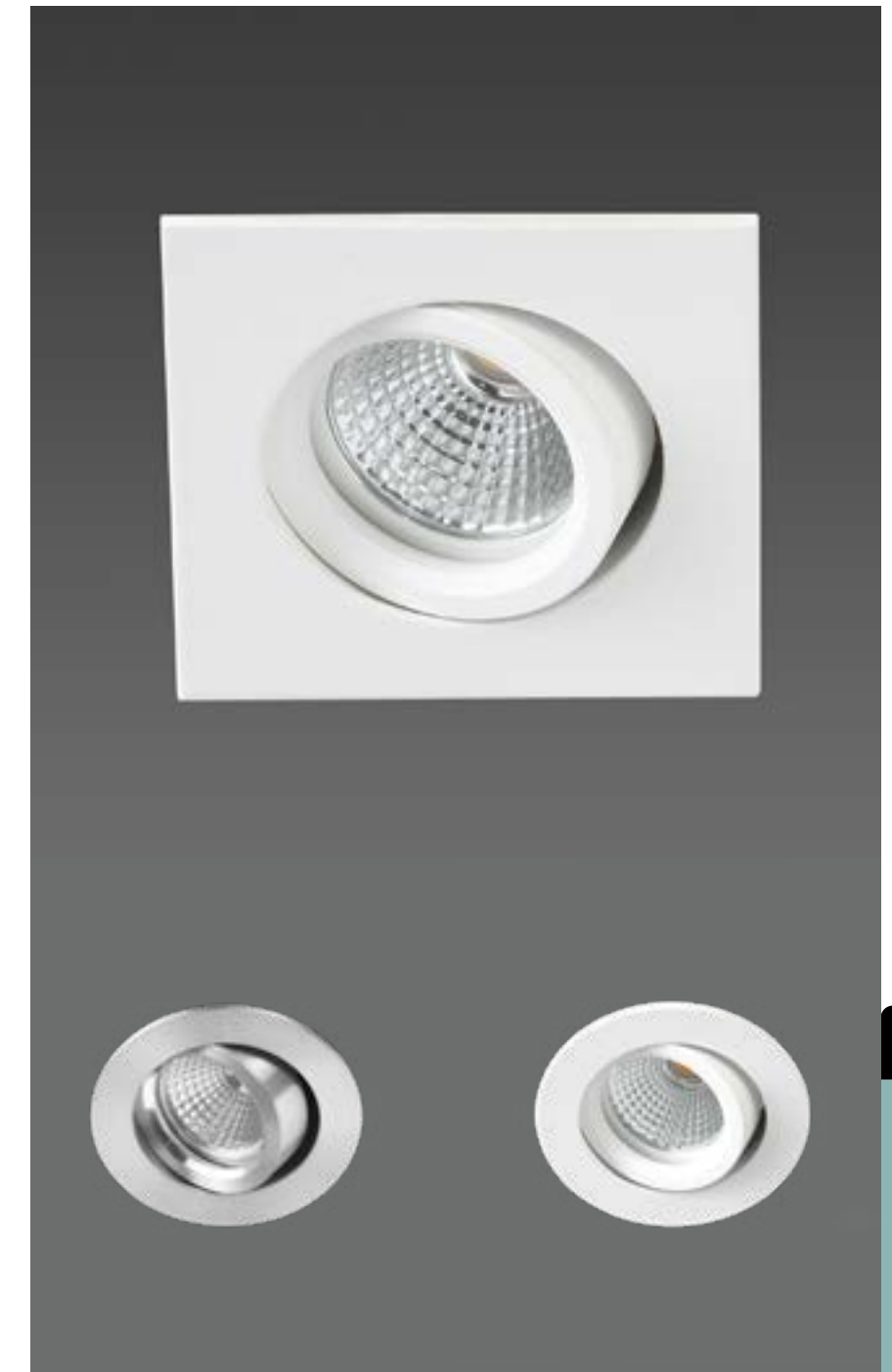

RECESSED FRAME

INSTALLATIONS

.RF
RECESSED FRAME

·3017 CATLI HALKA | RF ·3021 CATLI HALKA SQ | RF
Pag. 568



PHOTOMETRY

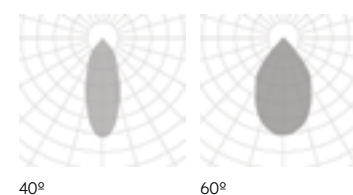

CATLI HALKA | HALKA SQ

REF 3017.RF | 3021.RF

CATLI ODALKI	REF.	DIMENSIONS	FINISHES	LAMP	OPTIC OPTIONS	POWER	CRI	K	LUMEN	WATT	mA	DIMM	SKETCH												
	3018	.01	●	GU5.3	■	GU5.3	.9			Max 8		▼													
				GU10		.GU								GU10	Max 8										
				LED	.40 .60	.ST								BPM50	.9			.27	526	8	350	.DA .PU .D1	26		
																			.30						570
																			.40						627
																			.27						707
																			.30						927
																			.40						767
				.HI	BPM300	.9																			

Reference order | 3018.01.RF.XX.XX.XX.XX.XX.XX

FINISHES

COLORS



DIMENSIONS

View in family specifications

.01

LIGHTING OPTIONS

BEAM ANGLE / LAMP

40° | 60° | GU5.3 | GU10

POWER

STANDARD | HIGH

CRI

90

COLOR TEMPERATURE

2700K | 3000K | 4000K

DIMMABLE OPTIONS

DALI | 1.10 | PUSH

LIGHT DISTRIBUTION

DOWN



Select finishes



.WH-WH | .SA-SA

INSTALLATIONS



CATLI ODALKI

REF 3018.RF

PHOTOMETRY

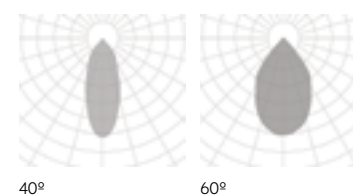

.RF
RECESSED FRAME

3018 CATLI ODALKI | RF
Pag. 570

CATLI CLASSIC	REF.	DIMENSIONS	FINISHES	LAMP	OPTIC OPTIONS	POWER	CRI	K	LUMEN	WATT	mA	DIMM	SKETCH					
	3005	.01	●	GU5.3	■	GU5.3	-	-	-	Max 8	-	▼						
				GU10		.GU				GU10				Max 8				
				LED	.40 .60	.9	●	■	■	.ST	-	-	-	8	350	-		
										BPM50								
										.HI								
										BPM300								
										.27								526
										.30								570
				.40	711													
				-	-	-	-	-	-	-	-	-	-	-	-	-		
.27	707																	
.30	927																	
.40	767																	

Reference order | 3005.01.RF.XX.XX.XX.XX.XX.XX

● Select finishes

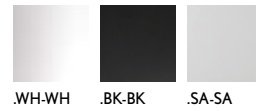

FINISHES

COLORS



DIMENSIONS

● View in family specifications

.01

LIGHTING OPTIONS

■ BEAM ANGLE / LAMP

40° | 60° | GU5.3 | GU10

POWER

STANDARD | HIGH

CRI

90

COLOR TEMPERATURE

2700K | 3000K | 4000K

▼ DIMMABLE OPTIONS

DALI | 1.10 | PUSH

▲ LIGHT DISTRIBUTION

DOWN

ON DEMAND

Dim to Warm
Tunable White
Wireless Control Options



.RF
RECESSED FRAME

INSTALLATIONS

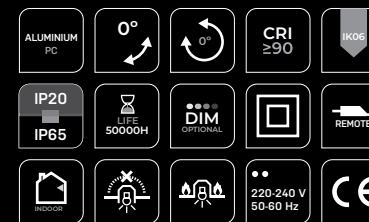

CATLI CLASSIC

REF 3005.RF

PHOTOMETRY

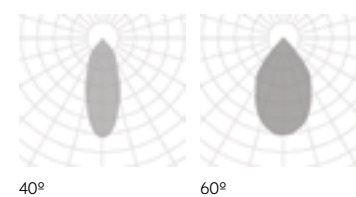

.RF
RECESSED FRAME

3005 CATLI CLASSIC | RF
Pag. 572

CATLI CLASSIC SQ	REF.	DIMENSIONS	FINISHES	LAMP	OPTIC OPTIONS	POWER	CRI	K	LUMEN	WATT	mA	DIMM	SKETCH				
	3006	.01	●	GU5.3	■	GU5.3	.9	-	-	Max 8	-	▼	 LED 55 GU 100				
				GU10	.GU	GU10				Max 8							
				LED	.40 .60	.ST				BPM50				8	350	.27	526
																.30	570
																.40	711
																.27	707
																.30	927
																.40	767
				.DA .PU .D1	85x85	26											

Reference order | 3006.01.RF.XX.XX.XX.XX.XX.XX

● Select finishes

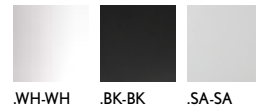

FINISHES

COLORS



DIMENSIONS

● View in family specifications

.01

LIGHTING OPTIONS

■ BEAM ANGLE / LAMP

40° | 60° | GU5.3 | GU10

POWER

STANDARD | HIGH

CRI

90

COLOR TEMPERATURE

2700K | 3000K | 4000K

▼ DIMMABLE OPTIONS

DALI | 1.10 | PUSH

▲ LIGHT DISTRIBUTION

DOWN

ON DEMAND

Dim to Warm
Tunable White
Wireless Control Options

IP 65



.RF

RECESSED FRAME

INSTALLATIONS

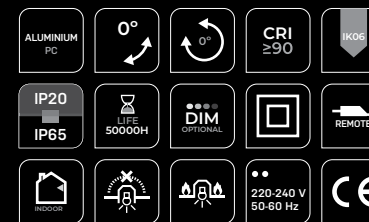

CATLI
CLASSIC SQ

REF 3006.RF

.RF
RECESSED FRAME

·3006 CATLI CLASSIC SQ | RF
Pag. 574

PHOTOMETRY

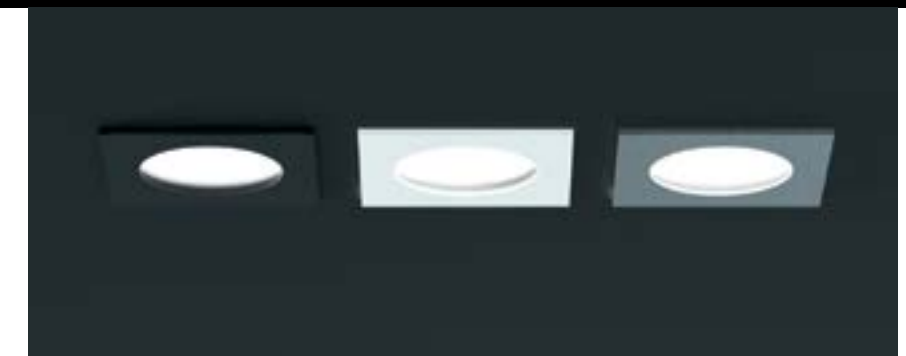
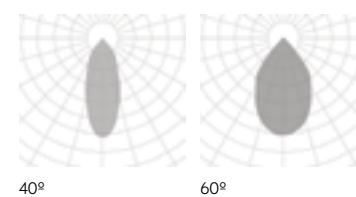

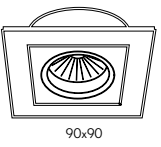
CATLI CARE	REF.	DIMEN-SIONS	FINISHES	LAMP	OPTIC OPTIONS	POWER	CRI	K	LUMEN*1	WATT	mA	DIMM	SKETCH																													
	3000	.01	●	GU5.3	■	GU5.3	.9	-	-	Max 8	-	▼																														
				GU10		.GU				GU10				Max 8																												
				LED	.40 .60	.ST				BPM50				.9	-	-	-	-	-	-	-	-	-																			
																								.HI	BPM300	-	-	-	-	-	-	-	-	-								
																																			.27	526	8	350	-	-	-	-
																								.30	570	10	500	-	-	-	-	-										
																																	.40	627								
																								.27	707	-	-	-	-	-	-											
				.30	730	-				-				-	-	-	-																									
																		.40	767	-	-	-	-	-	-																	

Reference order 3000.01.RF.XX.XX.XX.X.XX.XX

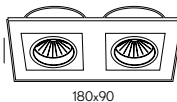
CATLI CARE 2	REF.	DIMEN-SIONS	FINISHES	LAMP	OPTIC OPTIONS	POWER	CRI	K	LUMEN*1	WATT	mA	DIMM	SKETCH																									
	3001	.01	●	GU5.3	■	GU5.3	.9	-	-	Max 2x8	-	▼																										
				GU10		.GU				GU10				Max 2x8																								
				LED	.40 .60	.ST				BPM50				.9	-	-	-	-	-	-	-	-																
																							.HI	BPM300	-	-	-	-	-	-	-							
																																.27	1052	16	350	-	-	-
																							.30	1140	20	500	-	-	-	-								
																															.40							
																							.27	1414	-	-	-	-	-	-								
				.30	1854	-				-				-	-	-	-																					
																		.40	1534	-	-	-	-	-	-													

Reference order 3001.01.RF.XX.XX.XX.X.XX.XX

● Select finishes



*1 Please might expect max. 15% value reduction in finishes other than white. / Puede haber una reducción máx. del 15% en el dato de los acabados al blanco.

FINISHES

COLORS



DIMENSIONS

View in family specifications

.01

LIGHTING OPTIONS

BEAM ANGLE / LAMP

40° | 60° | GU5.3 | GU10

POWER

STANDARD

CRI

90

COLOR TEMPERATURE

2700K | 3000K | 4000K

DIMMABLE OPTIONS

DALI | 1.10 | PUSH

LIGHT DISTRIBUTION

DOWN

ON DEMAND

Dim to Warm
Tunable White
Wireless Control Options



RECESSED FRAME

INSTALLATIONS

.RF
RECESSED FRAME

·3000 CATLI CARE ·3001 CATLI CARE 2 |RF
Pag. 576





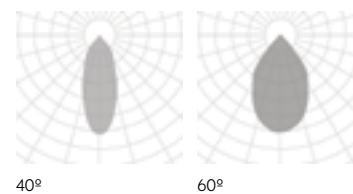

















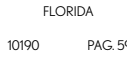



PHOTOMETRY





















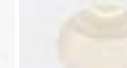





CATLI CARE | CARE 2

REF 3000.RF | 3001.RF

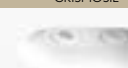
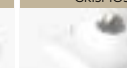
TRIMLESS

ALABAMA		ALABAMA 10158 PAG. 580	ALTAIR		ALTAIR 10172 PAG. 584
OHIO		OHIO 10188 PAG. 588		OHIO SQ 10204 PAG. 592	FLORIDA
ALBERTA		ALBERTA 10176 PAG. 604		FLORIDA 10190 PAG. 596	
ALARIK		ALARIK MINI 210006 PAG. 614		ALARIK SLIM 20224 PAG. 622	FLORIDA SQ
ALBA		ALBA MINI 10211 PAG. 640		ALBA 10160 PAG. 644	
WING		WING 10200 PAG. 660		ALBA ASIMETRIC 210009 PAG. 648	
SASSY		SASSY 410002 PAG. 668		ALBA PLUS 10178 PAG. 652	EYE
LUK		LUK FREIR 20018 PAG. 680		ALBA PLUS ASIMETRIC 210008 PAG. 656	
VITA		VITA 30007 PAG. 688	MARTORELL		MARTORELL 20115 PAG. 676
VOLCANO		VOLCANO 10062 PAG. 690	MARTORELL TARREGA		MARTORELL TARREGA 20117 PAG. 678
		VOLCANO DEEP 10063 PAG. 692	MARTORELL TARREGA SQ		MARTORELL TARREGA SQ 20118 PAG. 678

VISUAL INDEX

ESPIGA		ESPIGA 10086 PAG. 694		ESPIGA SQ 10083 PAG. 696		ESPIGA SIRIO 10077 PAG. 698		ESPIGA SIRIO TWINS 30000 PAG. 700		ESPIGA ORIONIS 10080 PAG. 702		ESPIGA ORIONIS TWINS 30001 PAG. 704		
ZENIT		ZENIT 10123 PAG. 706		ZENIT SQ 30002 PAG. 706		ZENIT DEEP 30004 PAG. 708		ZENIT DEEP TWINS 30005 PAG. 709		ZENIT MOVE 10125 PAG. 710		ZENIT MOVE SQ 30003 PAG. 711		
SUNSET		SUNSET 10124 PAG. 716	ZENIT ORTO		ZENIT ORTO 10126 PAG. 712	ZENIT SIDEREA		ZENIT SIDEREA 10050 PAG. 713	ZENIT ZUBIA		ZENIT ZUBIA 10122 PAG. 714	ZENIT ZUBIA SQ		ZENIT ZUBIA SQ 10121 PAG. 715
VEGA		VEGA ADHARA 10016 PAG. 718		VEGA ADHARA TWINS 10066 PAG. 720		VEGA 10028 PAG. 722		VEGA TWINS 10070 PAG. 724		VEGA ZETA 10001 PAG. 726		VEGA ZETA SQ 10019 PAG. 728		
CENTAURO		CENTAURO 10109 PAG. 732	VEGA ZETA SQ TWINS		VEGA ZETA SQ TWINS 10072 PAG. 730									



FINISHES

● COLORS



DIMENSIONS

● DIAMETERS mm.

350 | 450 | 650 | 950 | 1250

LIGHTING OPTIONS

■ DIFFUSERS

OPAL | MICROPRISMATIC

POWERS

STANDARD | HIGH

CRI

90

COLOR TEMPERATURE

2700K | 3000K | 4000K | TW

▼ DIMMABLE OPTIONS

DALI | 1.10 | PUSH

▲ LIGHT DISTRIBUTION OPTIONS

DOWN

LUMINAIRE INCLUDES

Trimless mounting kit



ON DEMAND

Special RAL Color
Special Color Temperature
Number of switches
Emergency Lighting*
CRI 80
Motion Detection
RGB
Wireless Control Options (Casambi)

* Accessories are delivered separately
(not installed in luminaire).

INSTALLATIONS



ALABAMA

REF 10158.TR

.PN
PENDANT

-10158 ALABAMA | PN
Pag. 78

.SR
SURFACE

-10158 ALABAMA | SR
Pag. 78

.RF
RECESSED FRAME

-10158 ALABAMA | RF
Pag. 396

.TR
TRIMLESS

-10158 ALABAMA | TR
Pag. 580

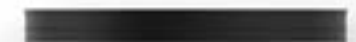

ALABAMA	REF.	DIMENSION	FINISH	DIFFUSER	POWER	CRI	K	LUMEN	WATT	mA	DIMM	SKETCH
	10158	.35	●	.OP .MP	.ST	.9	.27	2295	18	500	.DA .PU .D1	
							.30	2385				
							.40	2475				
					.HI	.9	.27	4590	35	500	.DA .PU .D1	
							.30	4767				Ø343
							.40	4956				

	10158	.45	●	.OP .MP	.ST	.9	.27	4590	35	500	.DA .PU .D1	
							.30	4770				
							.40	4950				
					.HI	.9	.27	11400-11820	76	700	.DA	
							.30	9180				Ø443
							.40	9534				

	10158	.65	●	.OP .MP	.ST	.9	.27	9180	71	500	.DA .PU .D1	
							.30	9540				
							.40	9900				
					.HI	.9	.27	22800-23640	152	700	.DA	
							.30	18360				Ø643
							.40	19068				

	10158	.95	●	.OP .MP	.ST	.9	.27	16830	130	500	.DA .PU .D1	
							.30	17490				
							.40	18150				
					.HI	.9	.27	41800-43340	279	700	.DA	
							.30	33660				Ø943
							.40	34958				

	10158	.125	●	.OP .MP	.ST	.9	.27	27540	212	500	.DA .PU .D1	
							.30	28620				
							.40	29700				
					.HI	.9	.27	68400-70920	457	700	.DA	
							.30	55080				Ø1243
							.40	57204				

Reference order | 10158.XX.TR.XX.XX.XX.XX.XX



Seamlessly tunable

Adapt to individual needs with the ability to control the color temperature output and enhance the experience.

Perfectamente ajustable

Adaptable a cada necesidad con la capacidad de controlar la salida de temperatura de color y mejorar la experiencia.

ALABAMA

REF 10158.TR



● Select finishes



PHOTOMETRY



OPAL MICROPRISMATIC

INCLUDED

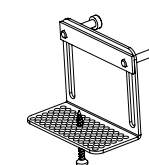

TR mounting KIT

PROFILE

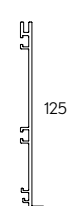

125

TR TRIMLESS



FINISHES

● COLORS



DIMENSIONS

● SIZES mm.

393x393 | 593x593 | 893x893 | 1193x1193

LIGHTING OPTIONS

■ DIFFUSERS

OPAL | MICROPRISMATIC

POWERS

STANDARD | HIGH

CRI

90

COLOR TEMPERATURE

2700K | 3000K | 4000K | TW

▼ DIMMABLE OPTIONS

DALI | 1.10 | PUSH

▲ LIGHT DISTRIBUTION OPTIONS

DOWN

LUMINAIRE INCLUDES

Trimless mounting kit

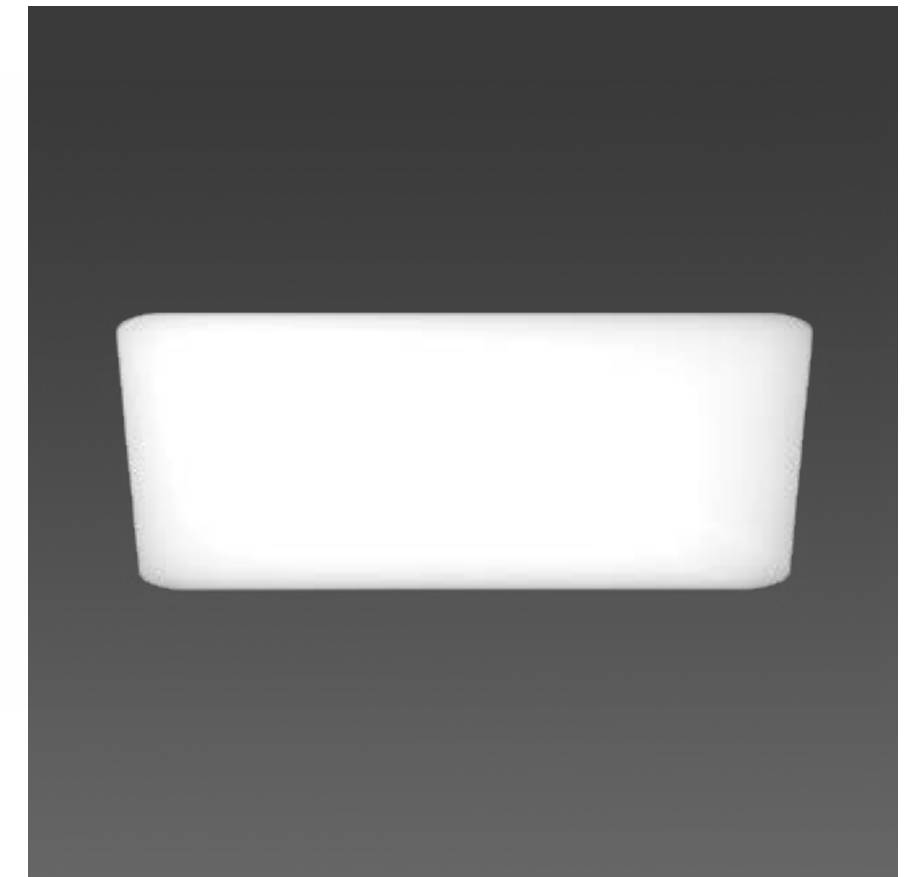

ON DEMAND

Special RAL Color
Special Color Temperature
Number of switches
Emergency Lighting*
CRI 80
Motion Detection
RGB
Wireless Control Options (Casambi)

* Accessories are delivered separately
(not installed in luminaire).

INSTALLATIONS



ALTAIR

REF 10172.TR

.PN
PENDANT

-10172 ALTAIR | PN
Pag. 82

.SR
SURFACE

-10172 ALTAIR | SR
Pag. 82

.TR
TRIMLESS

-10172 ALTAIR | TR
Pag. 584



ALTAIR	REF.	DIMENSION ▲	FINISH	DIFFUSER ■	POWER	CRI	K	LUMEN	WATT	mA	DIMM ▼	SKETCH
	10172	.45	.WH-WH	.OP .MP	.ST	.9	.27	3825	24	500	.DA .PU .D1	
							.30	3975				
							.40	4125				
					.HI	.9	.27	7600 - 7880	51	700	.DA	
							.30	6120				
							.40	6356				
	10172	.65	.WH-WH	.OP .MP	.ST	.9	.27	6120	47	500	.DA .PU .D1	
							.30	6360				
							.40	6600				
					.HI	.9	.27	15200 - 15760	102	700	.DA	
							.30	12240				
							.40	12712				
	10172	.95	.WH-WH	.OP .MP	.ST	.9	.27	11475	89	500	.DA .PU .D1	
							.30	11925				
							.40	12375				
					.HI	.9	.27	28500 - 29550	191	700	.DA	
							.30	22950				
							.40	23835				
	10172	.125	.WH-WH	.OP .MP	.ST	.9	.27	18360	142	500	.DA .PU .D1	
							.30	19080				
							.40	19800				
					.HI	.9	.27	45600 - 47280	305	700	.DA	
							.30	36720				
							.40	38136				
						.40	39648	283	500	.DA .PU .D1		

Reference order | 10172.XX.TR.WH-WH.XX.XXX.XXX.XX



TR
TRIMLESS

- ALUMINUM PC
- 0°
- 0°
- CRI ≥90
- IK05
- IP20 / IP43
- LIFE 50000H
- DIM OPTIONAL
- INTEGRATED
- REcess
- REcess
- 220-240 V 50-60 Hz
- CE

ALTAIR

REF 10172.TR

PHOTOMETRY

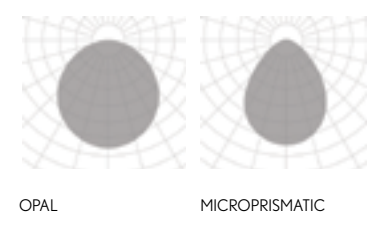

INCLUDED

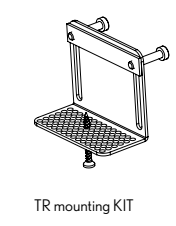

PROFILE

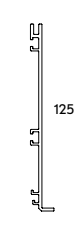



FINISHES

● COLORS



DIMENSIONS

● DIAMETERS mm.

350 | 450 | 650 | 950 | 1250

LIGHTING OPTIONS

■ DIFFUSERS

OPAL | MICROPRISMATIC

POWERS

STANDARD

CRI

90

COLOR TEMPERATURE

2700K | 3000K | 4000K

▼ DIMMABLE OPTIONS

DALI | 1.10 | PUSH

▲ LIGHT DISTRIBUTION OPTIONS

DOWN

LUMINAIRE INCLUDES

Trimless mounting kit



ON DEMAND

Special RAL Color
Special Color Temperature
Number of switches
Emergency Lighting*
Motion Detection
Wireless Control Options (Casambi)

* Delivered separately
(not installed in luminaire).

INSTALLATIONS

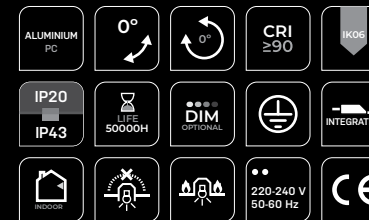

OHIO

REF 10188.TR

.PN
PENDANT

·10188 OHIO|PN
Pag. 86

.SR
SURFACE

·10188 OHIO|SR
Pag. 86

.RF
RECESSED FRAME

·10188 OHIO|RF
Pag. 400

.TR
TRIMLESS

·10188 OHIO|TR
Pag. 588

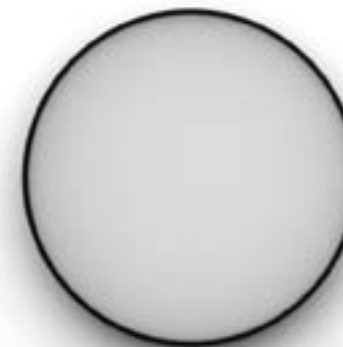

OHIO	REF.	DIMENSION	FINISH	DIFFUSER	POWER	CRI	K	LUMEN	WATT	mA	DIMM	SKETCH
	10188	.35	●	.OP .MP	.ST	.9	.27	-	18	700	.DA .PU .D1	
							.30	2385				
							.40	2475				
	10188	.45	●	.OP .MP	.ST	.9	.27	4590	35	700	.DA .PU .D1	
							.30	4770				
							.40	4950				
	10188	.65	●	.OP .MP	.ST	.9	.27	9180	71	700	.DA .PU .D1	
							.30	9540				
							.40	9900				
	10188	.95	●	.OP .MP	.ST	.9	.27	16830	130	700	.DA .PU .D1	
							.30	17490				
							.40	18150				
	10188	.125	●	.OP .MP	.ST	.9	.27	27540	212	700	.DA .PU .D1	
							.30	28620				
							.40	29700				

Reference order | 10188.XX.TR.XX.XX.ST9.XX.XX



• Select finishes



OHIO

REF 10188.TR

PHOTOMETRY



OPAL MICROPRISMATIC

INCLUDED

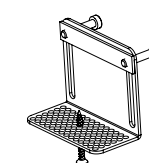

TR mounting KIT

PROFILE

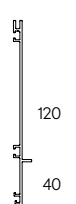

TR
TRIMLESS



FINISHES

● COLORS



DIMENSIONS

● SIZES mm.

343x343 | 443x443 | 643x643 | 943x943 | 1243x1243

LIGHTING OPTIONS

■ DIFFUSERS

OPAL | MICROPRISMATIC

POWERS

STANDARD

CRI

90

COLOR TEMPERATURE

2700K | 3000K | 4000K | TW

▼ DIMMABLE OPTIONS

DALI | 1.10 | PUSH

▲ LIGHT DISTRIBUTION OPTIONS

DOWN

LUMINAIRE INCLUDES

Trimless mounting kit



ON DEMAND

Special RAL Color
Special Color Temperature
Number of switches
Emergency Lighting*
Motion Detection
Wireless Control Options (Casambi)

* Delivered separately
(not installed in luminaire).

TRIMLESS

INSTALLATIONS

.RF
RECESSED FRAME

·10204 OHIOSQ|RF
Pag. 404

.TR
TRIMLESS

·10204 OHIOSQ|TR
Pag. 592



OHIO
SQ

REF 10204.TR



OHIO SQ	REF.	DIMENSION	FINISH	DIFFUSER	POWER	CRI	K	LUMEN	WATT	mA	DIMM	SKETCH
	10204	.35	●	.OP .MP	.ST	.9	.27	2295	18	500	.DA .PU .D1	
							.30	2385				
							.40	2475				
	10204	.45	●	.OP .MP	.ST	.9	.27	4590	35	500	.DA .PU .D1	
							.30	4770				
							.40	4950				
	10204	.65	●	.OP .MP	.ST	.9	.27	9180	71	500	.DA .PU .D1	
							.30	9540				
							.40	9900				
	10204	.95	●	.OP .MP	.ST	.9	.27	18360	142	500	.DA .PU .D1	
							.30	19080				
							.40	19800				
	10204	.125	●	.OP .MP	.ST	.9	.27	30600	236	500	.DA .PU .D1	
							.30	31800				
							.40	33000				

Reference order | 10204.XX.TR.XX.XX.ST9.XX.XX

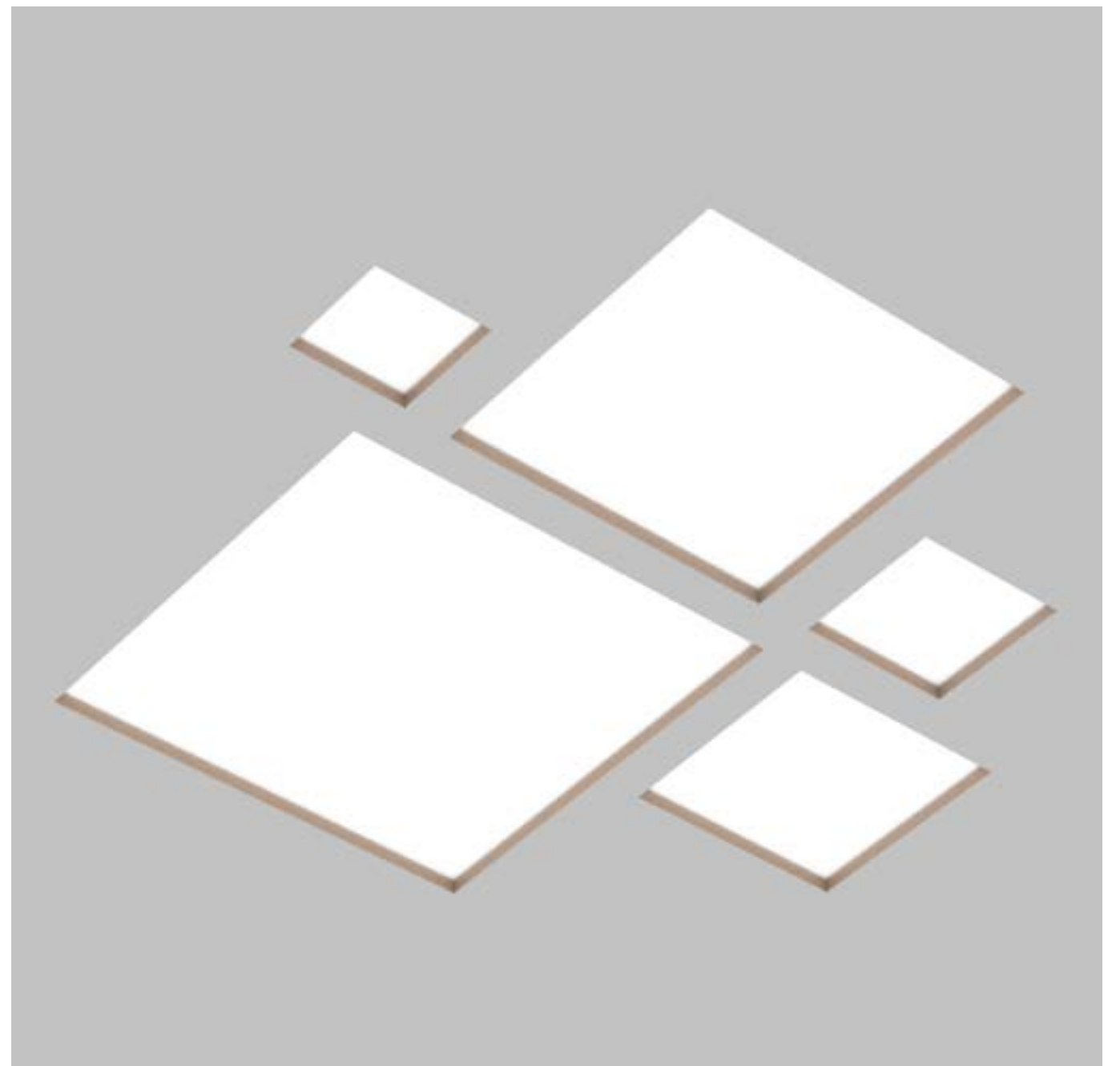

• Select finishes



OHIO
SQ

REF 10204.TR

PHOTOMETRY

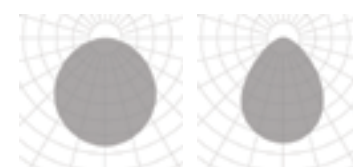

OPAL MICROPRISMATIC

INCLUDED

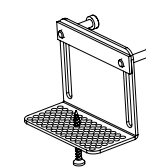

TR mounting KIT

PROFILE



TRIMLESS



FINISHES

EXTERNAL COLOR



INTERNAL COLOR



DIMENSIONS

DIAMETERS mm.

450 | 650 | 950 | 1250

LIGHTING OPTIONS

DIFFUSERS

OPAL

MICROPRISMATIC

POWERS

STANDARD

CRI

90

COLOR TEMPERATURE

2700K | 3000K | 4000K

▼ DIMMABLE OPTIONS

DALI

1.10

PUSH

▲ LIGHT DISTRIBUTION OPTIONS

DOWN

LUMINAIRE INCLUDES

Trimless mounting kit



ON DEMAND

Special RAL Color
Number of switches
Emergency Lighting*
Motion Detection
Wireless Control Options (Casambi)

* Accessories are delivered separately
(not installed in luminaire).

INSTALLATIONS

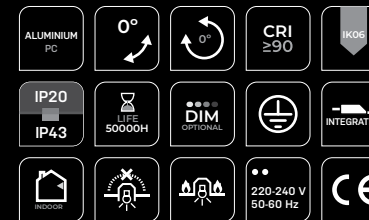

FLORIDA

REF 10190.TR

.PN
PENDANT

-10190 FLORIDA | PN
Pag. 90

.SR
SURFACE

-10190 FLORIDA | SR
Pag. 90

.RF
RECESSED FRAME

-10190 FLORIDA | RF
Pag. 408

.TR
TRIMLESS

-10190 FLORIDA | TR
Pag. 596

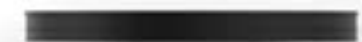

FLORIDA	REF.	DIMENSION	FINISH	DIFFUSER	POWER	CRI	K	LUMEN	WATT	mA	DIMM	SKETCH
	10190	.45	●	.OP .MP	.ST	.9	.27	4510	45	700	.DA .PU .D1	
							.30	4900				
							.40	5000				
	10190	.65	●	.OP .MP	.ST	.9	.27	10824	109	700	.DA .PU .D1	
							.30	11760				
							.40	12000				
	10190	.95	●	.OP .MP	.ST	.9	.27	19844	200	700	.DA .PU .D1	
							.30	21560				
							.40	22000				
	10190	.125	●	.OP .MP	.ST	.9	.27	31570	318	700	.DA .PU .D1	
							.30	34300				
							.40	35000				

Reference order | 10190.XX.TR.XX.XX.ST9.XX.XX

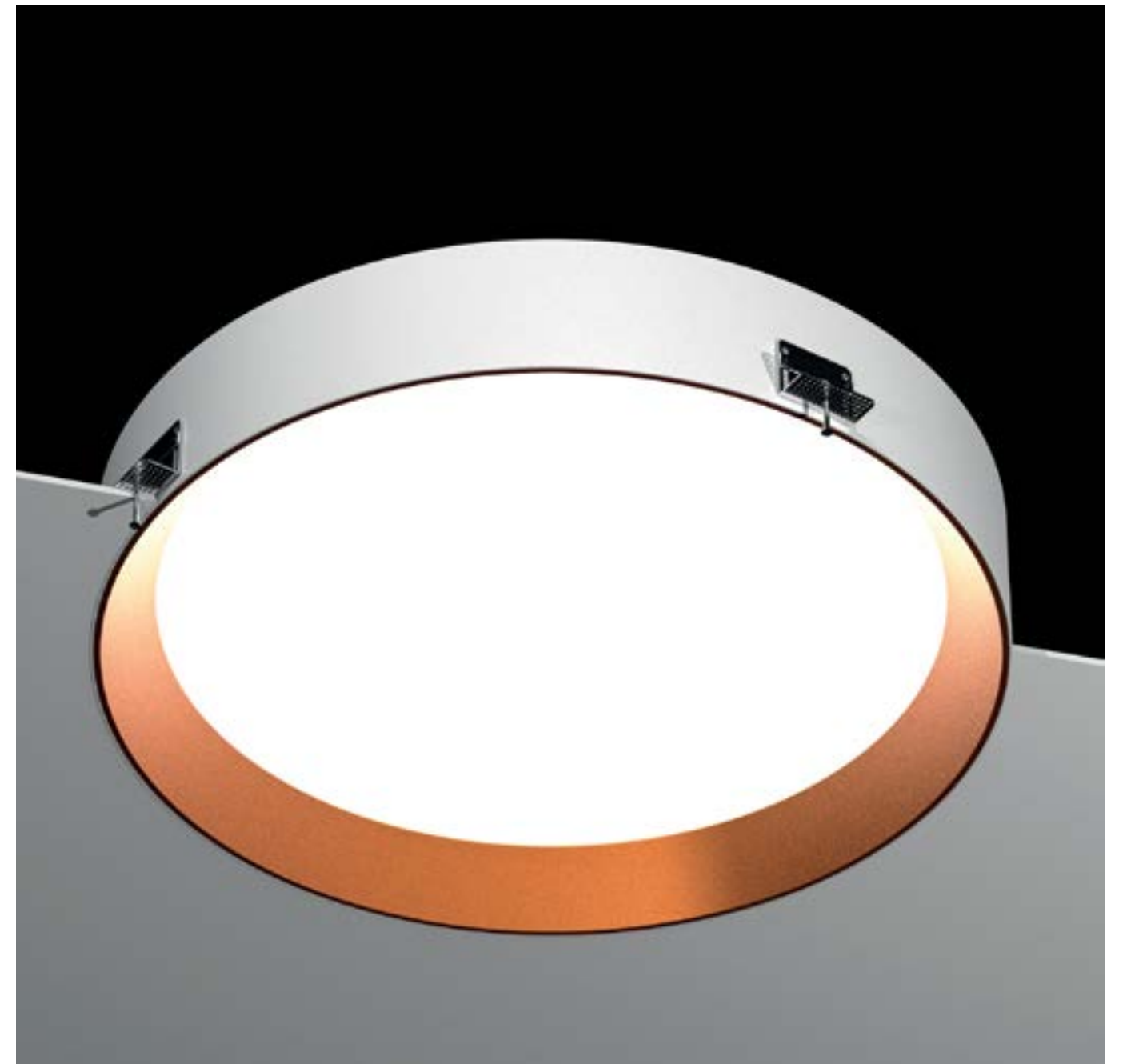

TR
TRIMLESS

Select finishes

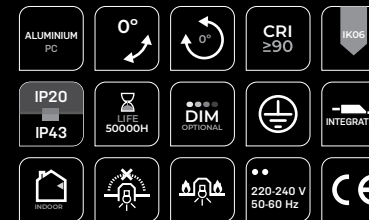

FLORIDA

REF 10190.TR

PHOTOMETRY

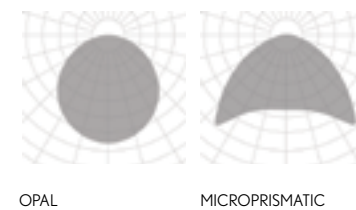

INCLUDED

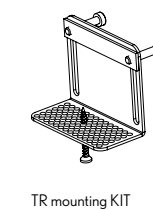

PROFILE

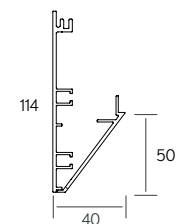



FINISHES

EXTERNAL COLOR



INTERNAL COLOR



DIMENSIONS

SIZES mm.

350x350 | 450x450 | 650x650 | 950x950 | 1250x1250

LIGHTING OPTIONS

DIFFUSERS

OPAL

MICROPRISMATIC

POWERS

STANDARD

CRI

90

COLOR TEMPERATURE

2700K | 3000K | 4000K

▼ DIMMABLE OPTIONS

DALI

1.10

PUSH

▲ LIGHT DISTRIBUTION OPTIONS

DOWN

LUMINAIRE INCLUDES

Trimless mounting kit



ON DEMAND

Special RAL Color
Number of switches
Emergency Lighting*
Motion Detection
Wireless Control Options (Casambi)

* Accessories are delivered separately
(not installed in luminaire).

TRIMLESS

INSTALLATIONS

.PN
PENDANT

-10191 FLORIDA SQ | PN
Pag. 94

.SR
SURFACE

-10191 FLORIDA SQ | SR
Pag. 94

.RF
RECESSED FRAME

-10191 FLORIDA SQ | RF
Pag. 412

.TR
TRIMLESS

-10191 FLORIDA SQ | TR
Pag. 600

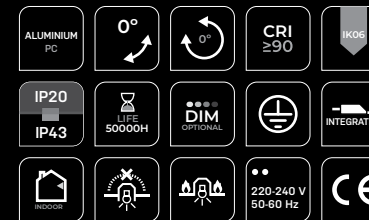

FLORIDA SQ

REF 10191.TR

FLORIDA SQ	REF.	DIMENSION	FINISH	DIFFUSER	POWER	CRI	K	LUMEN	WATT	mA	DIMM	SKETCH
	10191	.35	●	.OP .MP	.ST	.9	.27	2706	27	700	.DA .PU .D1	
							.30	2940				
							.40	3000				
	10191	.45	●	.OP .MP	.ST	.9	.27	5412	55	700	.DA .PU .D1	
							.30	5880				
							.40	6000				
	10191	.65	●	.OP .MP	.ST	.9	.27	10824	109	700	.DA .PU .D1	
							.30	11760				
							.40	12000				
	10191	.95	●	.OP .MP	.ST	.9	.27	21648	218	700	.DA .PU .D1	
							.30	23520				
							.40	24000				
	10191	.125	●	.OP .MP	.ST	.9	.27	36080	364	700	.DA .PU .D1	
							.30	39200				
							.40	40000				

Reference order 10191.XX.TR.XX.XX.ST9.XX.XX



Select finishes



FLORIDA SQ

REF 10191.TR

PHOTOMETRY

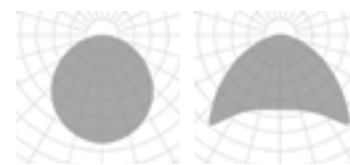

OPAL MICROPRISMATIC

INCLUDED

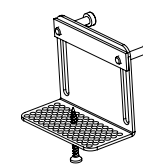

TR mounting KIT

PROFILE

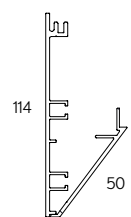

TR

TRIMLESS



FINISHES

● COLORS



DIMENSIONS

● DIAMETERS mm.

650 | 950 | 1250

LIGHTING OPTIONS

■ DIFFUSERS

OPAL | MICROPRISMATIC

POWERS

STANDARD | HIGH

CRI

90

COLOR TEMPERATURE

2700K | 3000K | 4000K | TW

▼ DIMMABLE OPTIONS

DALI | 1.10 | PUSH

▲ LIGHT DISTRIBUTION OPTIONS

DOWN

LUMINAIRE INCLUDES

Trimless mounting kit

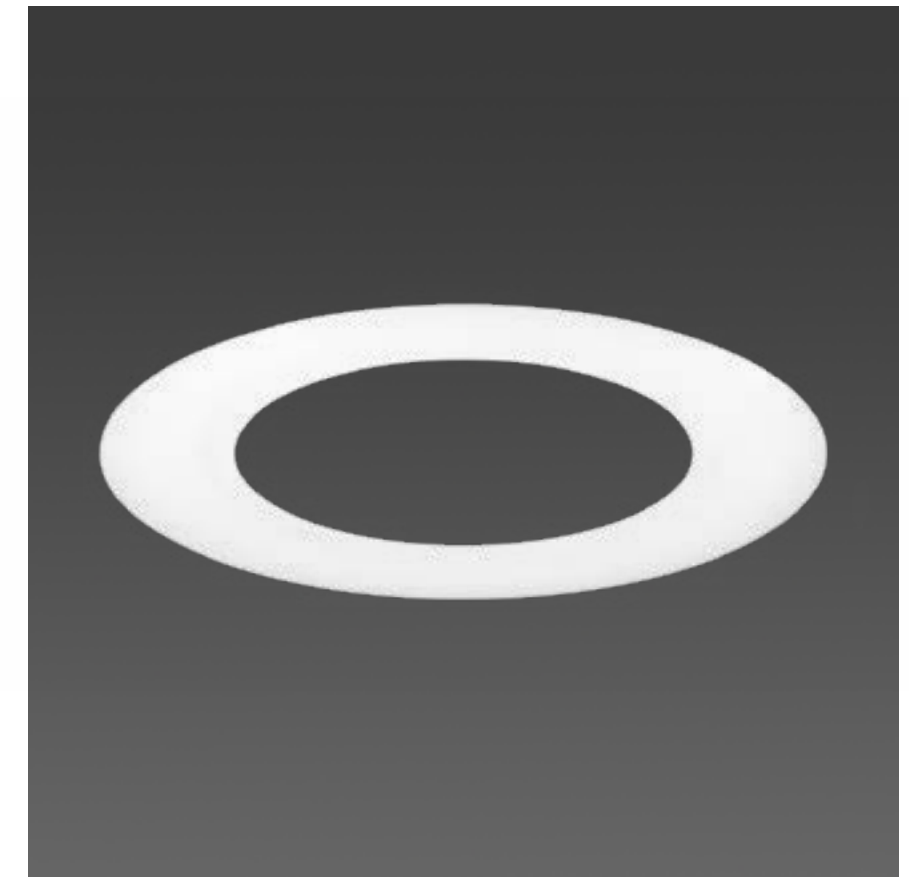

ON DEMAND

Special RAL Color
Special Color Temperature
Number of switches
Emergency Lighting*
CRI 80
Motion Detection
RGB
Wireless Control Options (Casambi)
Other Dimensions

* Accessories are delivered separately
(not installed in luminaire).

INSTALLATIONS

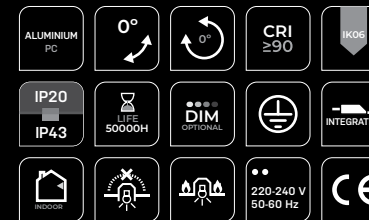

ALBERTA

REF 10176.TR



.PN
PENDANT

·10176 ALBERTA | PN
Pag. 132



.RF
RECESSED FRAME

·10176 ALBERTA | RF
Pag. 420

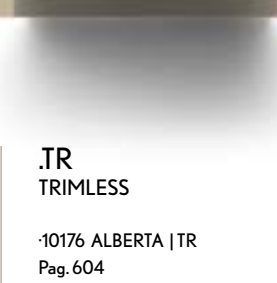

.TR
TRIMLESS

·10176 ALBERTA | TR
Pag. 604

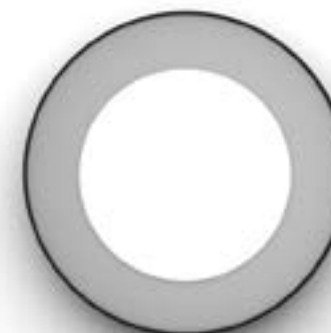

ALBERTA	REF.	DIMENSION	FINISH	DIFFUSER	POWER	CRI	K	LUMEN	WATT	mA	DIMM	SKETCH
	10176	.65	.WH-WH	.OP .MP	.ST	.9	.27	3060	24	500	.DA .PU .D1	
							.30	3180				
							.40	3300				
					.HI	.9	.8	.TW *1	9500 - 9850	64	700	.DA
							.9	.27	-	59	500	.DA .PU .D1
								.30	6356			
.40	6608											
	10176	.95	.WH-WH	.OP .MP	.ST	.9	.27	6120	47	500	.DA .PU .D1	
							.30	6360				
							.40	6600				
					.HI	.9	.8	.TW *1	15200 - 15760	102	700	.DA
							.9	.27	-	94	500	.DA .PU .D1
								.30	12712			
.40	13216											
	10176	.125	.WH-WH	.OP .MP	.ST	.9	.27	9180	71	500	.DA .PU .D1	
							.30	9540				
							.40	9900				
					.HI	.9	.8	.TW *1	22800-23640	152	700	.DA
							.9	.27	-	142	500	.DA .PU .D1
								.30	19068			
.40	19824											

Reference order | 10176.XX.TR.WH-WH.XX.XX.X.XX.XX



- ALUMINUM PC
- 0°
- 0°
- CRI ≥ 90
- IK05
- IP20 / IP43
- LIFE 50000H
- DIM OPTIONAL
- INTEGRATED
- RECOIL
- RECOIL
- RECOIL
- 220-240 V 50-60 Hz
- CE

ALBERTA

REF 10176.TR

PHOTOMETRY

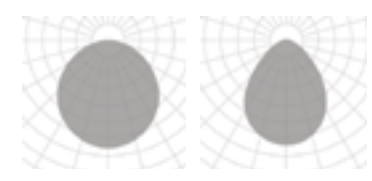

OPAL MICROPRISMATIC

INCLUDED

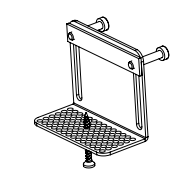

TR mounting KIT

PROFILE

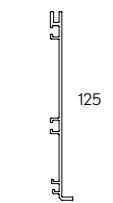

*1 Tunable White (TW) values correspond to 2700K and 6500K - TW is only available for DALI DT8 dimmable (DA), CRI 80 (8) 700mA. Los valores del blanco dinámico (TW) corresponden a 2700K y 6500K. -TW solo está disponible con protocolo DALI DT8 (DA), CRI 80 (8) 700mA.



A blank canvas

There are no limits Don't worry about lighting. Imagine the end result and use our Line profiles to make it happen. Few collections can be combined in so many ways to create so many looks and fulfil so many functions. It's the joker in the pack for designing unique spaces.

Un lienzo en blanco

Vía libre. No pensar en las luminarias. Pensar en el resultado final, y nuestra perfilera lineal se adaptará a ello. Pocas colecciones se prestan a tantas combinaciones, tanto estéticas como de funcionamiento, por ello es un comodín a la hora de diseñar espacios que requieren de un plus de singularidad.

LINES

TRIMLESS



FINISHES

● PROFILE COLORS



● EYE COLORS



DIMENSIONS

● LENGTHS mm.

1m.

LIGHTING OPTIONS

■ DIFFUSERS

ACRYLIC

POWER

STANDARD

CRI

90

COLOR TEMPERATURE

2700K | 3000K | 4000K |

▼ DIMMABLE OPTIONS

-

▲ LIGHT DISTRIBUTION

DOWN

LUMINAIRE INCLUDES

Trimless mounting kit

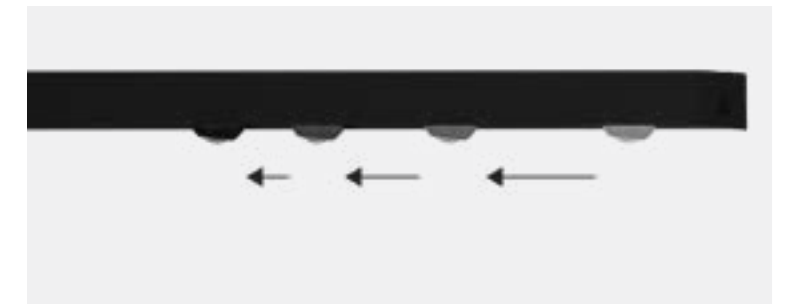
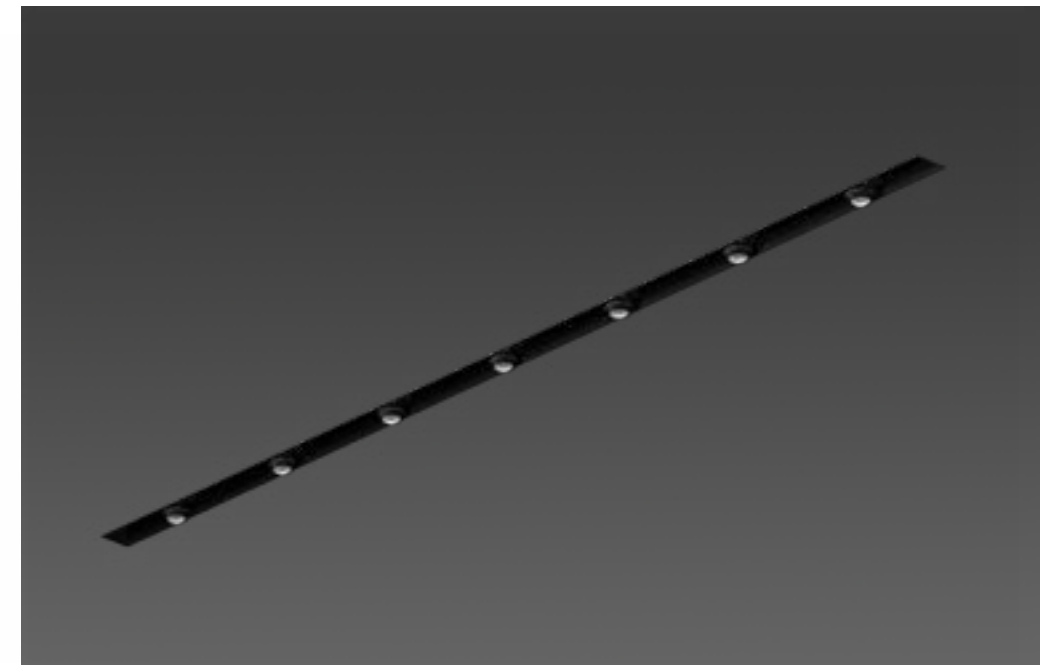

INSTALLATIONS

.PN
PENDANT

·210016 EYE|PN
Pag. 158

.SR
SURFACE

·210016 EYE|SR
Pag. 158

.TR
TRIMLESS

·210016 EYE|TR
Pag. 610



EYE

REF 210016.TR

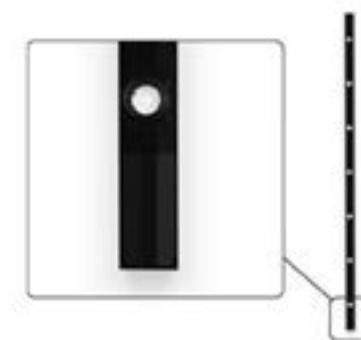

TRIMLESS

.TR

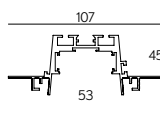
EYE	REF.	DIMENSION	FINISH	SKETCH
	210016	.01	.BK-BK .WH-WH	

Reference order | 210016.XX.TR.XX

48V TRANSFORMER	DIMENSION	WATT
DR48	.01	75
	.02	120
	.03	200

Reference order | DR48.XX

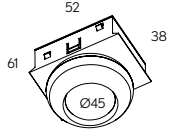
EYE MODULE	REF.	DIMENSION	FINISH	OPTIC OPTIONS	POWER	CRI	LUMEN			WATT	VdC	DIMM	SKETCH
							.27	.30	.40				
	20210	.01	●	.AC	.ST	.9	360	420	475	8	48	-	

Reference order | 20210.01.XX.AC.ST9.XX

COMPONENTS

COVER KIT	REF.	FINISH
	TF16	●

Reference order | TF16.TR.XX

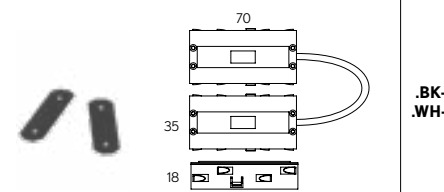
LINEAR JOINT + FLEXIBLE JOINT CONNECTOR	FINISH
	● .BK-BK .WH-WH

Reference order | UR16.XX

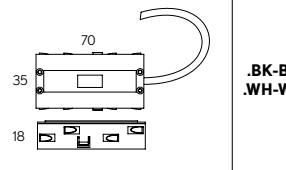
POWER FEEDER UNIT	FINISH
	● .BK-BK .WH-WH

Reference order | ACC210016.CA.XX

 Total length = Profile length + 2x3mm (Cover kit)

 (Total length + 2mm) x 75mm

 75mm

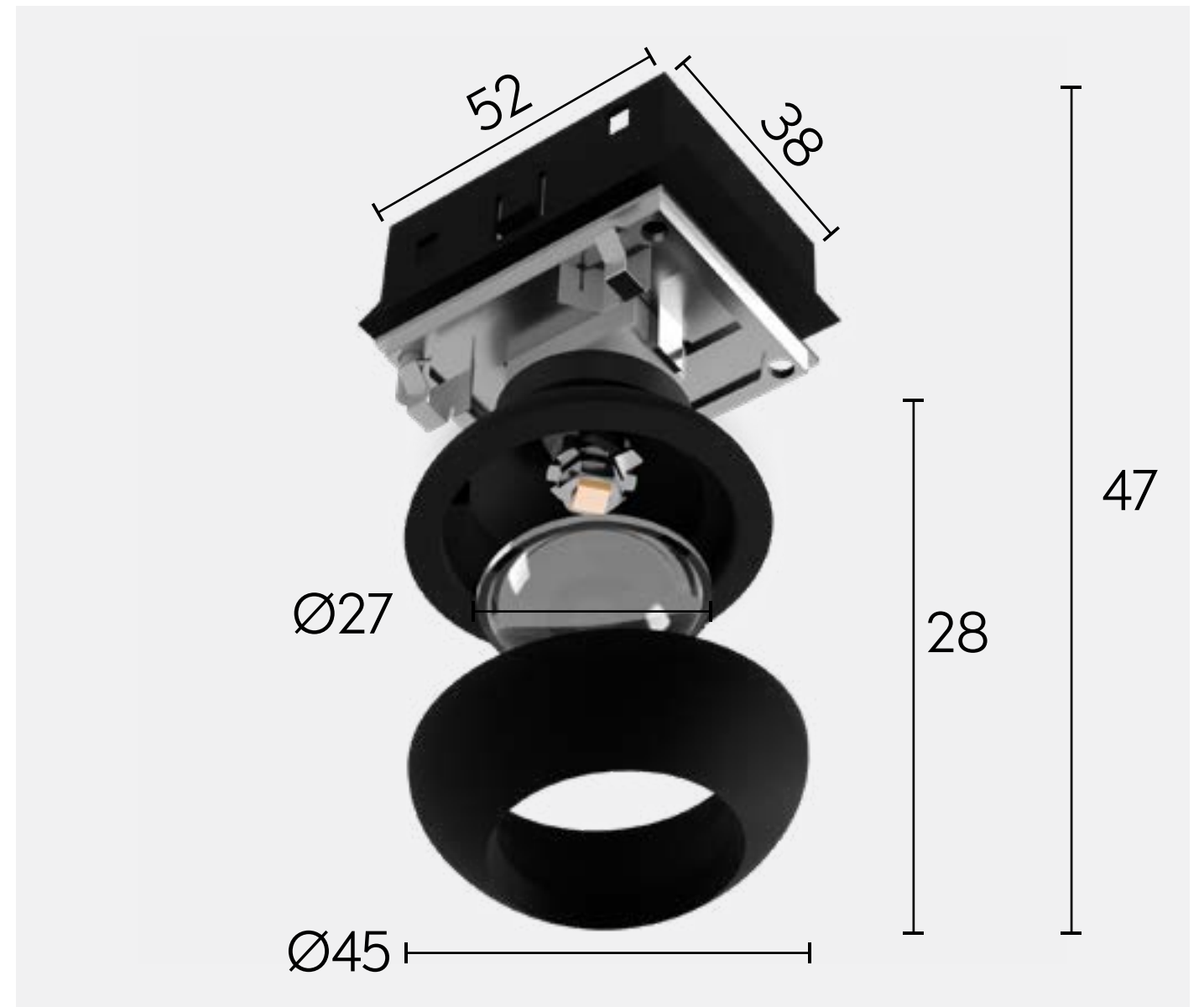

TRIMLESS

● Select profile finishes

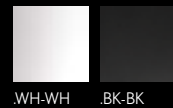

.WH-WH .BK-BK

● Select eye module finishes



.WH-WH .BK-BK .GC-GC

ALUMINIUM PC	0°	0°	CRI ≥90	IK05
IP20 IP43	LIFE 50000H		48V. REMOTE	
RECOOL			220-240 V 50-60 Hz	CE

EYE

REF 210016.TR

PHOTOMETRY



OPAL

PROFILE

12,5mm Standard Ceiling

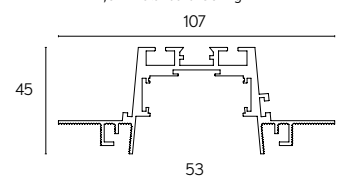

53



MINI PATRICIA
450001

MINI PATRICIA
450001

MINI PATRICIA ROUND LENSES
450005

MINI PATRICIA LOL
450002

MINI PATRICIA FLAT
450007



MINI MOTION LENSES
450004

MINI LENSES
450005

MINI PATRICIA ZOOM
450003

MINI LED MODULES
450006

ALARIK MINI



new

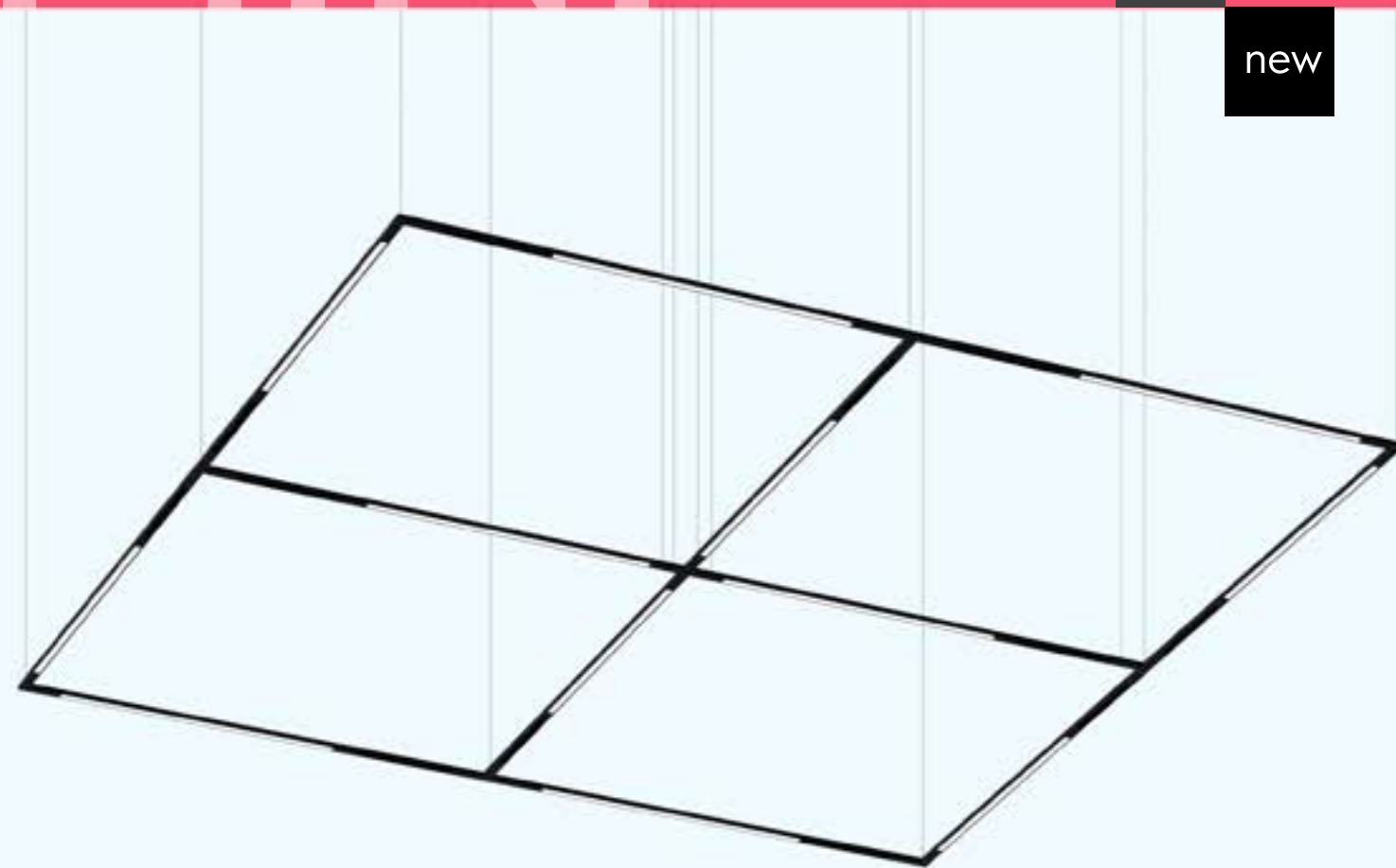



new

FINISHES

● COLORS



DIMENSIONS

● LENGTHS

PER METER

COMPONENTS

MINI PATRICIA
MINI PATRICIA LOL
MINI PATRICIA ZOOM
MINI MOTION LENSES
MINI LENSES
MINI LED MODULES
MINI PATRICIA FLAT
MINI PATRICIA ROUND LENSES

POWER

STANDARD

CRI

90

COLOR TEMPERATURE

2700K | 3000K | 4000K

▼ DIMMABLE OPTIONS

DALI

▲ LIGHT DISTRIBUTION

DOWN

LUMINAIRE INCLUDES

Trimless mounting kit



ON DEMAND
Profile Special RAL Color
Custom dimensions

INSTALLATIONS

.PN
PENDANT

·210006 ALARIK MINI | PN
Pag. 164

.SR
SURFACE

·210006 ALARIK MINI | SR
Pag. 164

.TR
TRIMLESS

·210006 ALARIK MINI | TR
Pag. 616

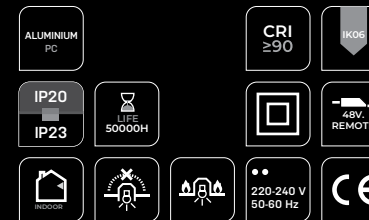

ALARIK MINI

REF 210006.TR

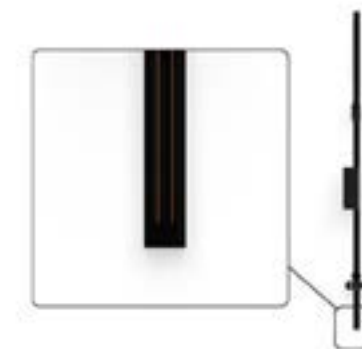

TRIMLESS

.TR

ALARIK MINI	DIMENSION	FINISH	SKETCH
	210006 .01 1m		

Reference order | 210006.XX.TR.XX

48V TRANSFORMER	DIMENSION	WATT
DR48	.01	75
	.02	120
	.03	200

Reference order | DR48.XX

POWER FEEDER	REF.	FINISH	SKETCH
	ACC210006.CA	.BK-BK .WH-WH	

Reference order | ACC210006.CA.XX

MINI PATRICIA ZOOM *1	REF.	DIMENSION	FINISH	OPTIC OPTIONS	POWER	CRI	K	LUMEN	WATT	VdC	DIMM	SKETCH
	450003	.01		.15-40	.ST	.9	.27	169	6	48	.DA	
							.30	172				
							.40	212				

Reference order | 450003.01.XX.XX.ST9.XX

MINI PATRICIA *1	REF.	DIMENSION	FINISH	OPTIC OPTIONS	POWER	CRI	K	LUMEN	WATT	VdC	DIMM	SKETCH
	450001	.01		.15 .24 .30	.ST	.9	.27	130	5	48	.DA	
							.30	145				
							.40	185				
	450001	.02		.15 .24 .30	.ST	.9	.27	396	8	48	.DA	
							.30	421				
							.40	476				

Reference order | 450001.XX.XX.XX.ST9.XX

MINI PATRICIA LOL *1	REF.	DIMENSION	FINISH	OPTIC OPTIONS	POWER	CRI	K	LUMEN	WATT	VdC	DIMM	SKETCH
	450002	.01		.15 .24 .36	.ST	.9	.27	397	6	48	.DA	
							.30	425				
							.40	460				

Reference order | 450002.01.XX.XX.ST9.XX

*1 LED Modules are Class III.
Los módulos LED son Clase III.

MINI PATRICIA FLAT *1	REF.	DIMENSION	FINISH	OPTIC OPTIONS	POWER	CRI	K	LUMEN	WATT	VdC	DIMM	SKETCH
	450007	.01		.15 .30 .36	.ST	.9	.27	425	5	48	.DA	
							.30	465				
							.40	481				

Reference order | 450007.01.XX.XX.ST9.XX

MINI PATRICIA ROUND LENSES *1	REF.	DIMENSION	FINISH	OPTIC OPTIONS	POWER	CRI	K	LUMEN	WATT	VdC	DIMM	SKETCH
	450008	.01		.30 .36 .60	.ST	.9	.27	550	9	48	.DA	
							.30	563				
							.40	648				

Reference order | 450008.01.XX.XX.ST9.XX

Total length = Profile length + 2x2mm (Cover kit).
 (Total length + 2mm) x 30mm.
 55mm.

• Select finishes

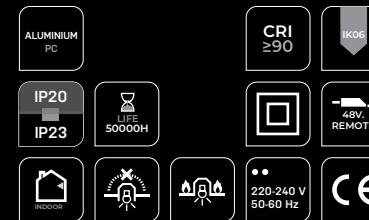
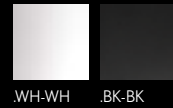

ALARIK MINI

REF 210006.TR

PHOTOMETRY

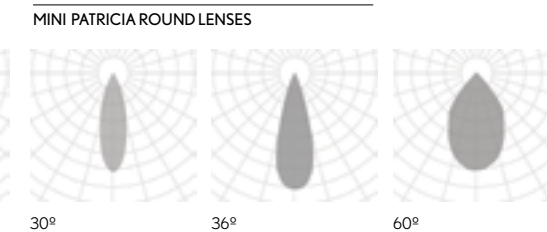
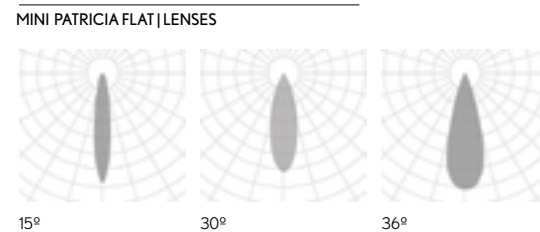
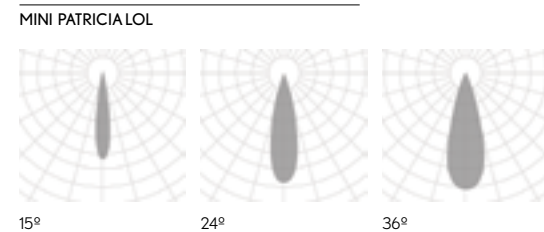
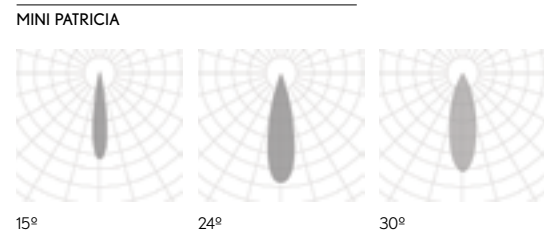

PROFILE

12,5mm Standard Ceiling

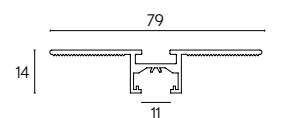

TRIMLESS

MINI LENSES *1	REF.	DIMENSION	FINISH	OPTIC OPTIONS	POWER	CRI	K	LUMEN	WATT	VdC	DIMM	SKETCH
	450005	.01	●	.23 .28 .36	.ST	.9	.27	538	9	48	.DA	
							.30	590				
							.40	682				

Reference order **450005.01.XX.XX.ST9.XX**

MINI MOTION LENSES *1	REF.	DIMENSION	FINISH	OPTIC OPTIONS	POWER	CRI	K	LUMEN	WATT	VdC	DIMM	SKETCH
	450004	.01	●	.23 .28 .36	.ST	.9	.27	547	9	48	.DA	
							.30	570				
							.40	634				

Reference order **450004.01.XX.XX.ST9.XX**

MINI LED MODULES *1	REF.	DIMENSION	FINISH	DIFFUSER	POWER	CRI	K	LUMEN	WATT	VdC	DIMM	SKETCH
	450006	.01	.BK-BK	.OP	.ST	.9	.27	473	6	48	-	
							.30	478				
							.40	486				
	450006	.02	.BK-BK	.OP	.ST	.9	.27	997	12	48	-	
							.30	1003				
							.40	1011				
	450006	.03	.BK-BK	.OP	.ST	.9	.27	2037	24	48	-	
							.30	2045				
							.40	2060				

*1 LED Modules are Class III.
Los módulos LED son Clase III.

Reference order **450006.XX.BK-BK.XX.ST9.XX**

COMPONENTS

COVER KIT	REF.	FINISH
	TF21 2x2mm.	●

Reference order **TF21.TR.XX**

JOINTS & CONNECTORS

LINEAR JOINT	ANGLE JOINT	CROSS JOINT	T-JOINT	WALL-CEILING JOINT	FINISH
					● .BK-BK .WH-WH
UR21	UL21	UC21	UT21	UV21	

Reference order **XX.XX**

● Select finishes

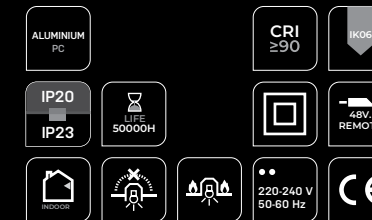
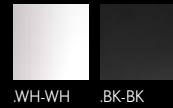

ALARIK MINI

REF 210006.TR

PHOTOMETRY

MINI LENSES | MINI MOTION LENSES

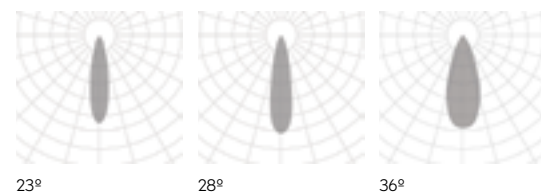

PHOTOMETRY

MINI LED MODULES

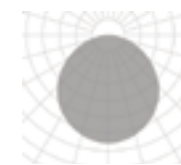

OPAL

PROFILE

12,5mm Standard Ceiling

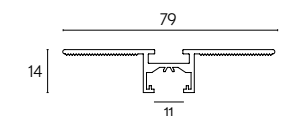

TRIMLESS



new

FINISHES

● COLORS



DIMENSIONS

● LENGTHS

PER METER

COMPONENTS

SLIM PATRICIA
SLIM PATRICIA ZOOM
SLIM LED BALL
SLIM TUBE
SLIM WALL WASHER
SLIM LENSES
SLIM MOTION LENSES
SLIM LED MODULES

POWER

STANDARD

CRI

90

COLOR TEMPERATURE

2700K | 3000K | 4000K

▼ DIMMABLE OPTIONS

DALI | 1.10

▲ LIGHT DISTRIBUTION

DOWN

LUMINAIRE INCLUDES

Trimless mounting kit

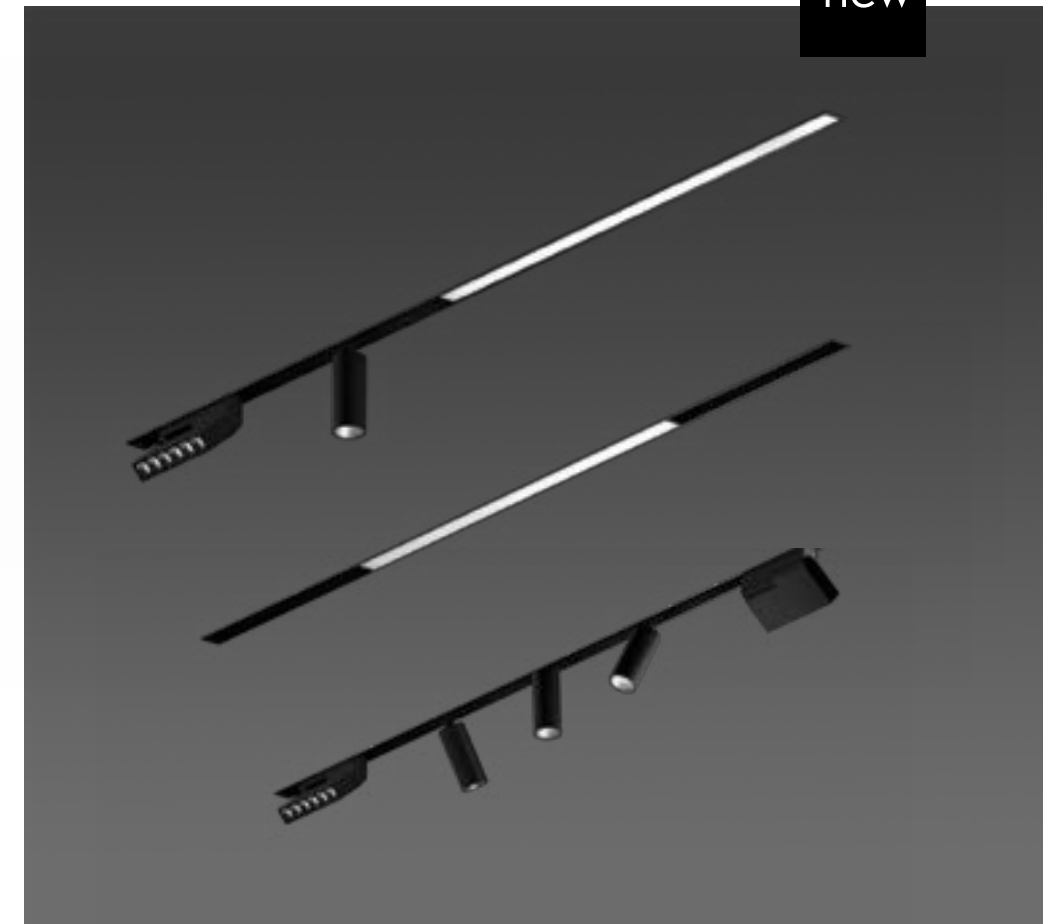

ON DEMAND
Profile Special RAL Color
Custom dimensions

INSTALLATIONS

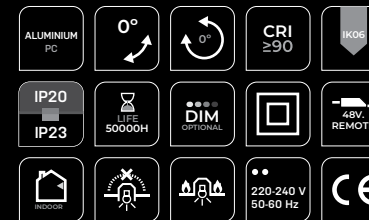
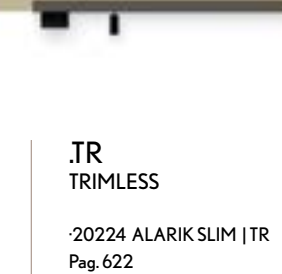

ALARIK SLIM

REF 20224.TR



TRIMLESS

.TR

ALARIK SLIM	REF.	DIMENSION	FINISH	SKETCH
	20224	.01 1 mt.	●	

48V TRANSFORMER	DIMENSION	WATT
DR48	.01	75
	.02	120
	.03	200

INTEGRATED POWER *1	REF.	WATT
	10246.DR (404x43x22mm)	200W

Reference order | 20224.XX.TR.XX

Reference order | DR48.XX

Reference order | 10246.DR

SLIM PATRICIA *2	REF.	DIMENSION	FINISH	OPTIC OPTIONS	POWER	CRI	K	LUMEN	WATT	VdC	DIMM	SKETCH
	11544	.01	●	.15 .38 .60	.ST	.9	.27	525	8	48	.DA .D1	
							.30	565				
							.40	660				
	11544	.02	●	.15 .38 .60	.ST	.9	.27	1070	15	48	.DA .D1	
							.30	1147				
							.40	1267				

Reference order | 11544.XX.XX.XX.ST9.XX.XX

SLIM PATRICIA ZOOM *2	REF.	DIMENSION	FINISH	OPTIC OPTIONS	POWER	CRI	K	LUMEN	WATT	VdC	DIMM	SKETCH
	11546	.01	●	.15-36 .36-60	.ST	.9	.27	1888	25	48	.DA .D1	
							.30	1995				
							.40	2191				

Reference order | 11546.01.XX.XX.ST9.XX.XX

SLIM LED BALL *2	REF.	DIMENSION	FINISH	OPTIC OPTIONS	POWER	CRI	K	LUMEN	WATT	VdC	DIMM	SKETCH
	11551	.01	●	.37	.ST	.9	.27	355	8	48	.DA .D1	
							.30	383				
							.40	396				

Reference order | 11551.01.XX.XX.ST9.XX.XX

*1 When adding 10246.DR, driver will be integrated in the luminaire | Cuando se añade 10246.DR, el driver irá integrado en la luminaria.

*2 LED Modules are Class III | Los módulos LED son Clase III.

SLIM LED TUBE 20 *2	REF.	DIMENSION	FINISH	OPTIC OPTIONS	POWER	CRI	K	LUMEN	WATT	VdC	DIMM	SKETCH
	11553	.01	●	.20 .40	.ST	.9	.27	174	3	48	.DA .D1	
							.30	187				
							.40	212				

Reference order | 11553.01.XX.XX.ST9.XX.XX

SLIM LED TUBE 40 *2	REF.	DIMENSION	FINISH	OPTIC OPTIONS	POWER	CRI	K	LUMEN	WATT	VdC	DIMM	SKETCH
	11552	.01	●	.20 .40	.ST	.9	.27	954	14	48	.DA .D1	
							.30	991				
							.40	1067				

Reference order | 11552.01.XX.XX.ST9.XX.XX

SLIM WALL WASHER *2	REF.	DIMENSION	FINISH	OPTIC OPTIONS	POWER	CRI	K	LUMEN	WATT	VdC	DIMM	SKETCH
	11550	.01	.BK-BK	-	.ST	.9	.27	882	15	48	.DA .D1	
							.30	1013				
							.40	1107				

Reference order | 11550.01.BK-BK.XX.ST9.XX.XX

SLIM LENSES *2	REF.	DIMENSION	FINISH	OPTIC OPTIONS	POWER	CRI	K	LUMEN	WATT	VdC	DIMM	SKETCH
	11548	.01	.BK-BK	.15 .38	.ST	.9	.27	725	8	48	.DA .D1	
							.30	750				
							.40	827				
	11548	.02	.BK-BK	.15 .38	.ST	.9	.27	1320	15	48	.DA .D1	
							.30	1511				
							.40	1654				

Reference order | 11548.XX.BK-BK.XX.ST9.XX.XX

● Select finish

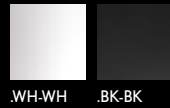

ALARIK SLIM

REF 2024.TR

PHOTOMETRY

SLIM PATRICIA | SLIM PATRICIA ZOOM

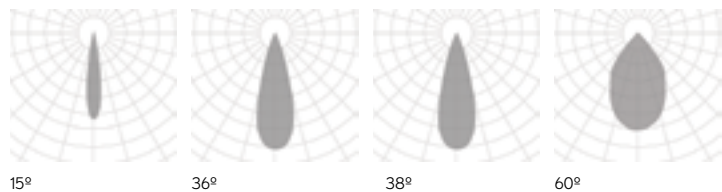

PHOTOMETRY

SLIM LED BALL | SLIM WALL WASHER



PHOTOMETRY

SLIM TUBE

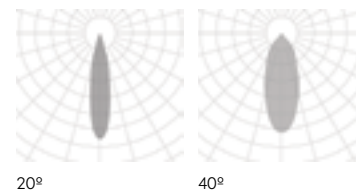

PHOTOMETRY

SLIM LENSES

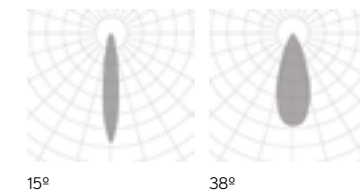

PROFILE

12,5mm Standard Ceiling

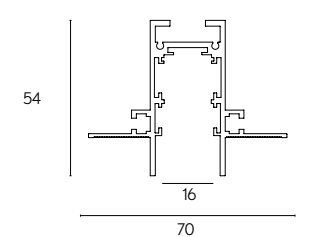

TRIMLESS

.TR

SLIM MOTION LENSES *2	REF.	DIMENSION	FINISH	OPTIC OPTIONS	POWER	CRI	K	LUMEN	WATT	VdC	DIMM	SKETCH
	11547	.01	.BK-BK	.15 .38	.ST	.9	.27	660	8	48	.DA .D1	
							.30	750				
							.40	827				

Reference order 11547.01.BK-BK.XX.ST9.XX.XX

SLIM LED MODULES *2	REF.	DIMENSION	FINISH	DIFFUSER	POWER	CRI	K	LUMEN	WATT	VdC	DIMM	SKETCH
	11549	.01	.BK-BK	.OP	.ST	.9	.27	558	9	48	.DA .D1	
							.30	560				
							.40	604				
	11549	.02	.BK-BK	.OP	.ST	.9	.27	1115	18	48	.DA .D1	
							.30	1120				
							.40	1208				
	11549	.03	.BK-BK	.OP	.ST	.9	.27	1670	24	48	.DA .D1	
							.30	1680				
							.40	1812				

*2 LED Modules are Class III.
Los módulos LED son Clase III.

Reference order 11549.XX.BK-BK.XX.ST9.XX.XX

Total length = Profile length + 2x3mm (Cover kit)
 (Total length + 2mm) x 55mm
 85mm

• Select finish

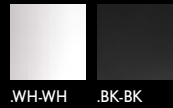

COMPONENTS

COVER KIT	REF.	FINISH
	TF19 2x3mm.	•

Reference order TF19.TR.XX

JOINTS & CONNECTORS

LINEAR JOINT	FINISH
	•
	.BK-BK .WH-WH

UR19.XX

ANGLE JOINT	FINISH
	•
	.BK-BK .WH-WH

UC19.XX

WALL-CEILING JOINT	FINISH
	•
	.BK-BK .WH-WH

UW19.XX

POWER FEEDER UNIT	FINISH
	•
	.BK-BK .WH-WH

ACC20224.CA.XX

*Corners and wall-ceiling joints require miter cut since they do not have a joint. Las esquinas y las figuras techo-pared requieren un corte a inglete ya que no tienen una unión.

ALUMINUM PC	0°	0°	CRI ≥90	IK05
IP20 IP23	LIFE 50000H	DIM OPTIONAL	48V. REMOTE	
RECORD			220-240 V 50-60 Hz	CE

ALARIK SLIM

REF 20224.TR

PHOTOMETRY

SLIM MOTION LENSES

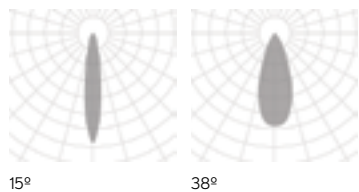

PHOTOMETRY

SLIM LED MODULES

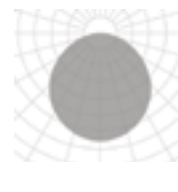

OPAL

PROFILE

12,5mm Standard Ceiling

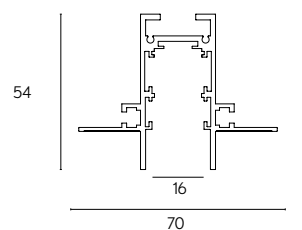

.TR

TRIMLESS



FINISHES

● COLORS



DIMENSIONS

● LENGTHS

PER METER

COMPONENTS

PATRICIA
LED MODULES
LENSES

POWER

STANDARD

CRI

90

COLOR TEMPERATURE

2700K | 3000K | 4000K

▼ DIMMABLE OPTIONS

DALI

▲ LIGHT DISTRIBUTION

DOWN

LUMINAIRE INCLUDES

Trimless mounting kit

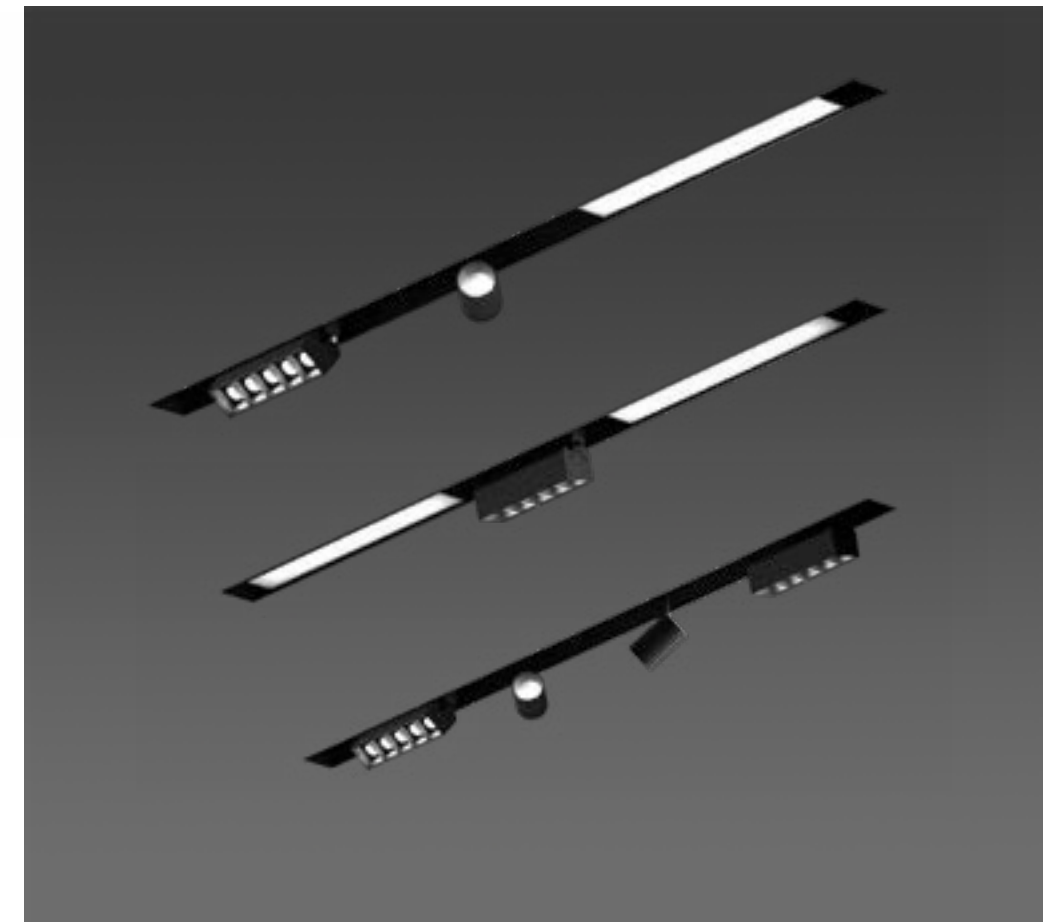

ON DEMAND
Profile Special RAL Color
Custom dimensions

INSTALLATIONS



.PN
PENDANT

·10225 ALARIK | PN
Pag. 190



.SR
SURFACE

·10225 ALARIK | SR
Pag. 190



.TR
TRIMLESS

·10225 ALARIK | TR
Pag. 628

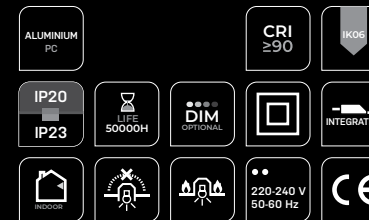

ALARIK

REF 10225.TR

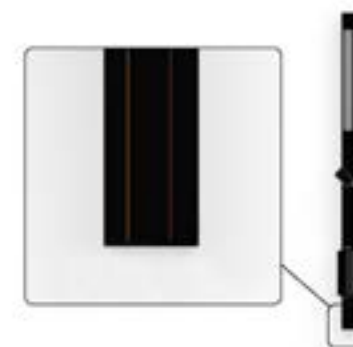

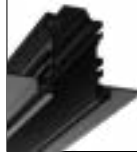
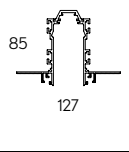

ALARIK	REF.	DIMENSION	FINISH	SKETCH
	10225	.01 1m	●	



48V TRANSFORMER	DIMENSION	WATT
DR48	.01	75
	.02	120
	.03	200

Reference order | 10225.XX.TR.XX

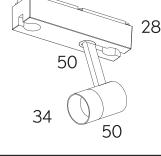
Reference order | DR48.XX

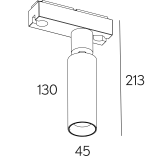

PATRICIA S *1	REF.	DIMENSION	FINISH	OPTIC OPTIONS	POWER	CRI	K	LUMEN	WATT	VdC	DIMM	SKETCH
  	20146	.01	●	.15 .24 .38	.ST	.9	.27	421	8	48	.DA	
							.30	440				
							.40	495				

Reference order | 20146.01.XX.XX.ST9.XX.XX

PATRICIA M *1	REF.	DIMENSION	FINISH	OPTIC OPTIONS	POWER	CRI	K	LUMEN	WATT	VdC	DIMM	SKETCH
  	20193	.01	●	.15 .24 .38	.ST	.9	.27	544	13	48	.DA	
							.30	626				
							.40	706				

Reference order | 20193.01.XX.XX.ST9.XX.XX



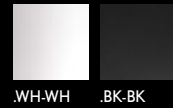

*1 LED Modules are Class III.
Los módulos LED son Clase III.

 Total length = Profile length + 10mm + 2x2mm (Cover kit)
 (Total length + 2mm) x 85mm
 115mm



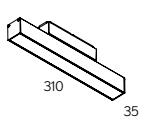

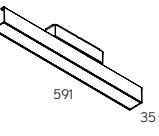
• Select finish

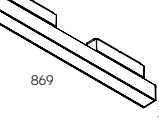

.WH-WH .BK-BK

LED MODULES *1	REF.	DIMENSION	FINISH	DIFFUSER	POWER	CRI	K	LUMEN	WATT	VdC	DIMM	SKETCH
	11542	.01	.BK-BK	.OP	.ST	.9	.27	306	6	48	.DA	
							.30	329				
							.40	352				
	11542	.02	.BK-BK	.OP	.ST	.9	.27	612	12	48	.DA	
							.30	657				
							.40	704				
	11542	.03	.BK-BK	.OP	.ST	.9	.27	955	18	48	.DA	
							.30	1031				
							.40	1081				

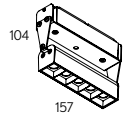
Reference order | 11542.XX.BK-BK.XX.ST9.XX.XX

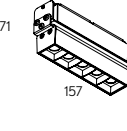
LENSES *1	REF.	DIMENSION	SHAPE	FINISH	OPTIC OP.	POWER	CRI	K	LUMEN	WATT	VdC	DIMM	SKETCH
 	11534	.05	.RD .SQ	.BK-BK	.20 .40 .60	.ST	.9	.27	660	10	48	.DA	
								.30	750				
								.40	827				
	11534	.05F	.RD .SQ	.BK-BK	.20 .40 .60	.ST	.9	.27	660	10	48	.DA	
								.30	750				
								.40	827				

Reference order | 11534.XX.XX.BK-BK.XX.ST9.XX.XX

 ROUND .RD
 26x29.3 mm
 Int Ø14,5 - Ext. Ø23 mm

 SQUARE .SQ
 26x29.3 mm
 Ø14,5 mm

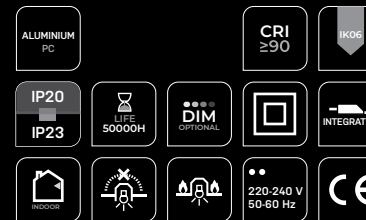

ALARIK

REF 10225.TR

PHOTOMETRY

PATRICIA

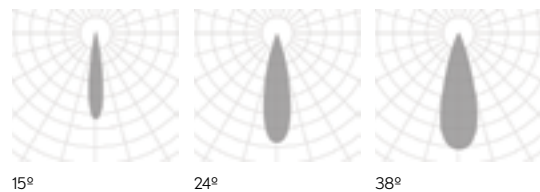

PHOTOMETRY

LENSES

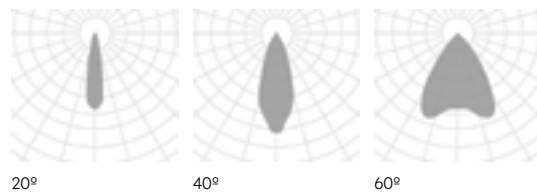

PHOTOMETRY

LED MODULES



PROFILE

12,5mm Standard Ceiling

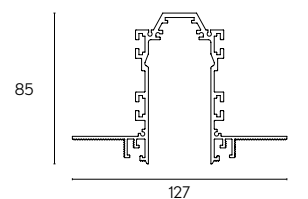





COMPONENTS

COVER KIT	REF.	FINISH
	TF18 2x2mm.	•

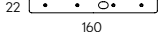
Reference order | TF18.TR.XX

JOINTS

LINEAR JOINT	ANGLE JOINT *2	T-JOINT	CROSS JOINT	WALL-CEILING JOINT	FINISH
				X	•
UR18	UL18	UT18	UC18	X	

Each corner requires an additional driver to that of the luminaire. Cada esquina requiere de un driver adicional al de la luminaria.
*2 Miter cut diffuser. Difusor a inglete.

Reference order | XX18.TR.XX



TRIMLESS

• Select finish

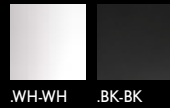

- ALUMINUM PC
- IP20 / IP23
- LIFE 50000H
- DIM OPTIONAL
- INTEGRATED
- 220-240 V 50-60 Hz
- CE
- CRI ≥90
- KOS

ALARIK

REF 10225.TR

PROFILE

12,5mm Standard Ceiling

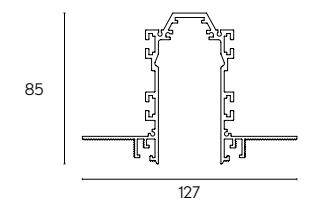



FINISHES

● COLORS



DIMENSIONS

● LENGTHS

PER METER

COMPONENTS

LED MODULES
LENSES
MINI TUBE
MINI TUBE STICK

POWER

STANDARD

CRI

90

COLOR TEMPERATURE

2700K | 3000K | 4000K

▼ DIMMABLE OPTIONS

DALI | 1.10 | PUSH

▲ LIGHT DISTRIBUTION

DOWN

LUMINAIRE INCLUDES

Trimless mounting kit

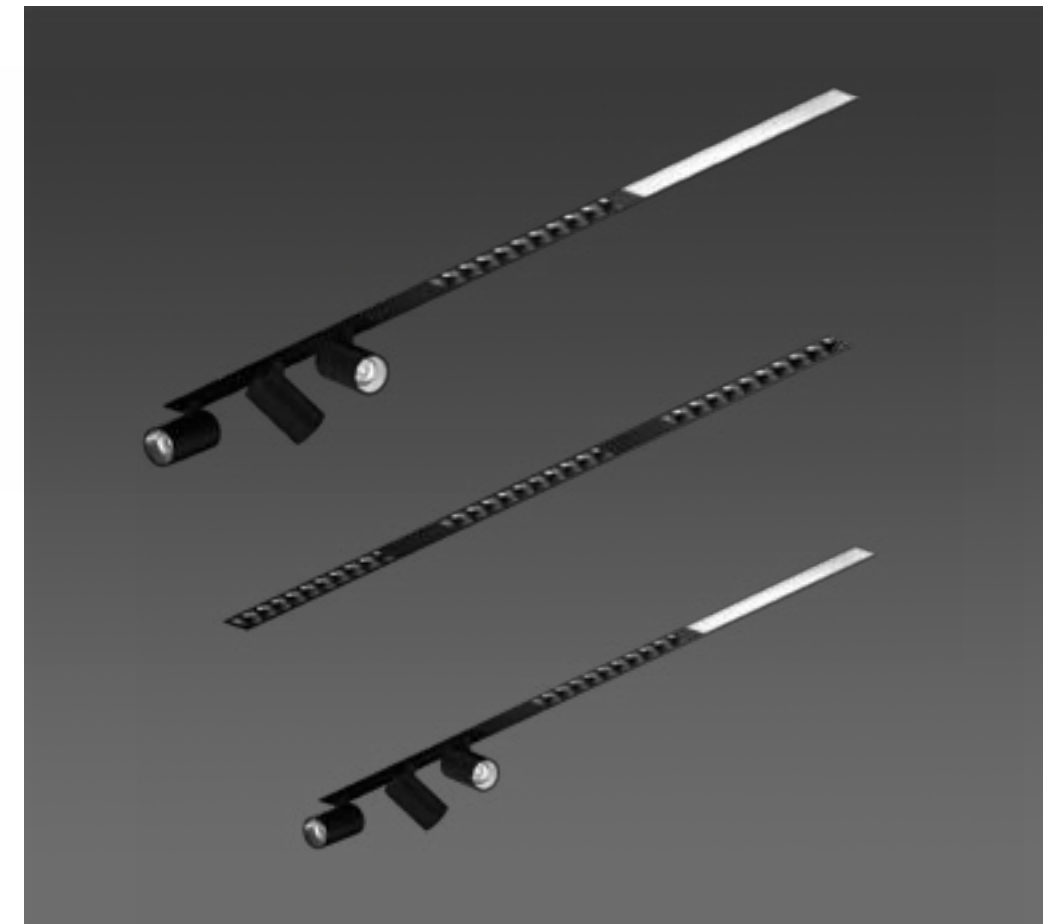

ON DEMAND

Special RAL Color
Special Shapes
Emergency Lighting*
Motion Detection
Custom dimensions
Special RAL Color
Tunable White

* Delivered separately
(not installed in luminaire).

INSTALLATIONS



.PN
PENDANT

·10210 MODULIGHT | PN
Pag. 196



.SR
SURFACE

·10210 MODULIGHT | SR
Pag. 196



.RF
RECESSED FRAME

·10210 MODULIGHT | RF
Pag. 434



.TR
TRIMLESS

·10210 MODULIGHT | TR
Pag. 634



MODULIGHT

REF 10210.TR

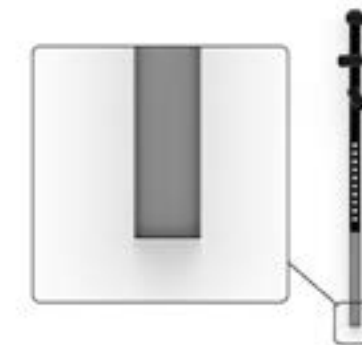

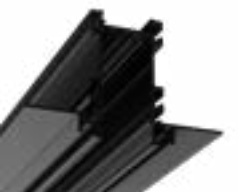
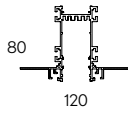
MODULIGHT	REF.	DIMENSION	FINISH	SKETCH
	10210	.01 1m	●	

Reference order | 10210.XX.TR.XX

DRIVER	DIMENSION*1	DIMM
DR10210	.01 0 - 15 W	.DA .PU .D1
	.02 16 - 30 W	
	.03 31 - 65 W	
	.04 66 - 90 W	

Reference order | DR10210.XX.XX

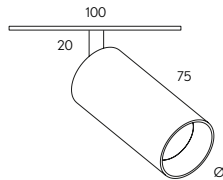
MINI TUBE	REF.	DIMENSION	FINISH	OPTIC OPTIONS	POWER	CRI	K	LUMEN	WATT	mA	SKETCH
 90° 350°	11526	.01	.BK-BK .WH-WH	.15 .24 .38	.ST	.9	.27	432	8	700	
							.30	445			
							.40	492			

Reference order | 11526.01.XX.XX.ST9.XX

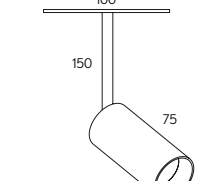
MINI TUBE STICK	REF.	DIMENSION	FINISH	OPTIC OPTIONS	POWER	CRI	K	LUMEN	WATT	mA	SKETCH
 90° 350°	11538	.01	.BK-BK .WH-WH	.15 .24 .38	.ST	.9	.27	432	8	700	
							.30	445			
							.40	492			





Reference order | 11538.01.XX.XX.ST9.XX

 Modular system that requires a technical drawing

*1 Driver power must be at least 15% higher than the sum of the power of selected LED modules. *La potencia del driver deber ser por lo menos un 15% mayor que la suma de la potencia de los modulos LED elegidos.*

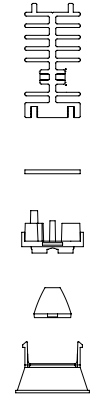
• Select finish



LENSES	REF.	DIMENSIONS	SHAPE	FINISH	OPTIC OPTIONS	POWER	CRI	K	LUMEN	WATT	mA	SKETCH
	11525	.01 29mm.	.RD .SQ	●	.20 .40 .60	.ST	.9	.27	161	2	700	
								.30	169			
								.40	176			
	11525	.03 80mm.	.RD .SQ	●	.20 .40 .60	.ST	.9	.27	483	6	700	
								.30	507			
								.40	528			
	11525	.05 133mm.	.RD .SQ	●	.20 .40 .60	.ST	.9	.27	805	10	700	
								.30	845			
								.40	880			
	11525	.10 263mm.	.RD .SQ	●	.20 .40 .60	.ST	.9	.27	1603	20	700	
								.30	1690			
								.40	1760			

Reference order | 11525.XX.XX.XX.XX.ST9.XX

COVER	REF.	FINISH
	ACC10210.01	●

Reference order | ACC10210.01.XX

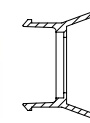
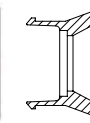

MODULIGHT

REF 10210.TR

PHOTOMETRY

MINI TUBE

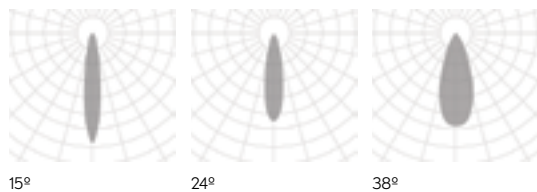

15° 24° 38°

PHOTOMETRY

MINI LENSES



20° 40° 60°

PROFILE

12,5mm Standard Ceiling

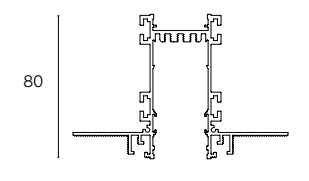

120

LED MODULES	REF.	DIMENSION ▲	DIFFUSER ■	POWER	CRI	K	LUMEN	WATT	mA	SKETCH
	11524	.01 281mm.	.OP .MP	.HI	.9	.27	1120	12	700	
						.30	1173			
						.40	1125			
	11524	.02 562mm.	.OP .MP	.HI	.9	.27	2240	24	700	
						.30	2346			
						.40	3375			
	11524	.03 843mm.	.OP .MP	.HI	.9	.27	3360	36	700	
						.30	3519			
						.40	3375			
	11524	.04 1124mm.	.OP .MP	.HI	.9	.27	4480	48	700	
						.30	4692			
						.40	4500			
	11524	.05 1405mm.	.OP .MP	.HI	.9	.27	5600	60	700	
						.30	5865			
						.40	5625			
	11524	.06 1686mm.	.OP .MP	.HI	.9	.27	6720	72	700	
						.30	7038			
						.40	6750			

Reference order 11524.XX.XX.HI.9.XX

COMPONENTS

COVER KIT	REF.	FINISH
	TF23 2x2mm.	●

Reference order TF23.TR.XX

JOINTS

LINEAR JOINT	ANGLE JOINT*2	T-JOINT	CROSS JOINT	WALL-CEILING JOINT	FINISH
		X	X		●
UR23	UL23	X	X	UV23	

Reference order XX23.TR.XX

● Select finish

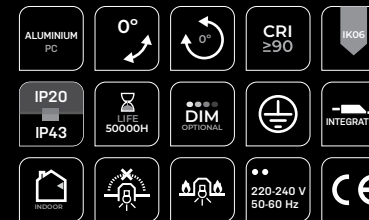

MODULIGHT

REF 10210.TR

PHOTOMETRY

LED MODULES

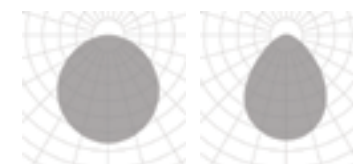

OPAL

MICROPRISMATIC

PROFILE

12,5mm Standard Ceiling

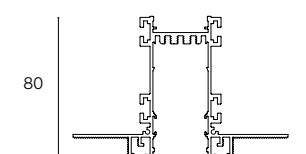

120

*2 Miter cut diffuser. Difusor a inglete.



FINISHES

● COLORS



DIMENSIONS

◆ ELECTRIC SYSTEM LENGTH mm.

843 | 1124 | 1405 | 1686 | 1967 | 2248

LIGHTING OPTIONS

■ DIFFUSERS

OPAL | MICROPRISMATIC

POWER

STANDARD | HIGH

CRI

90

COLOR TEMPERATURE

2700K | 3000K | 4000K | TW

▼ DIMMABLE OPTIONS

DALI | 1.10 | PUSH

▲ LIGHT DISTRIBUTION

DOWN

LUMINAIRE INCLUDES

Trimless mounting kit

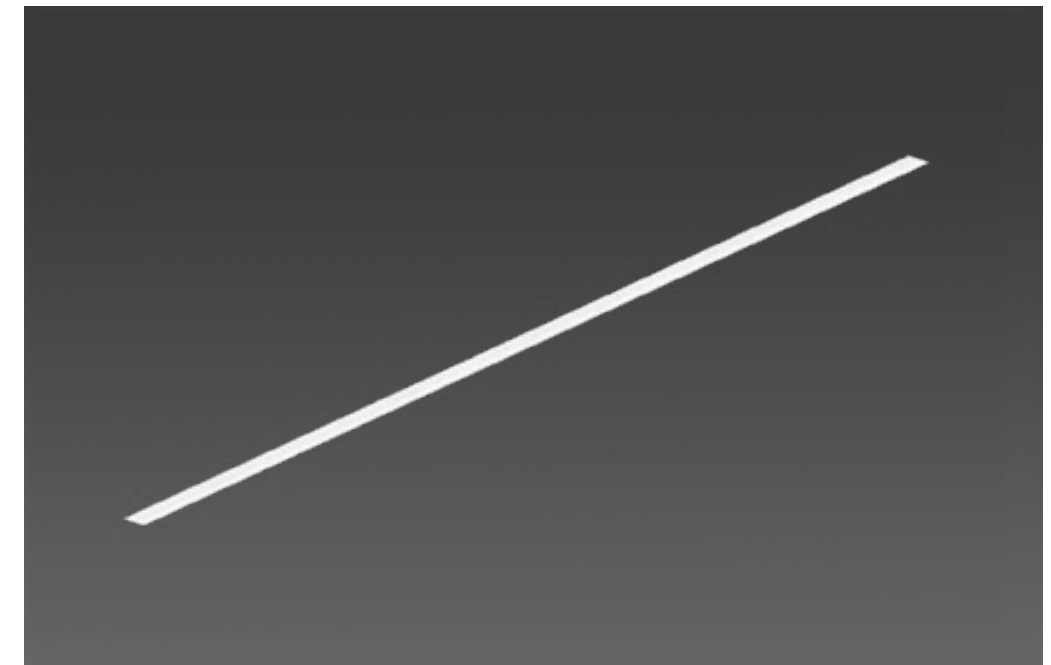

ON DEMAND

Special RAL Color
Emergency Lighting*
Motion Detection
Custom dimensions
Special Color Temperature
RGB
Thematic LED
Wireless Control Options (Casambi)
CRI 80

* Delivered separately
(not installed in luminaire).

INSTALLATIONS

.PN
PENDANT

·10211 ALBA MINI|PN
Pag. 226

.SR
SURFACE

·10211 ALBA MINI|SR
Pag. 226

.RF
RECESSED FRAME

·10211 ALBA MINI|RF
Pag. 440

.TR
TRIMLESS

·10211 ALBA MINI|TR
Pag. 640

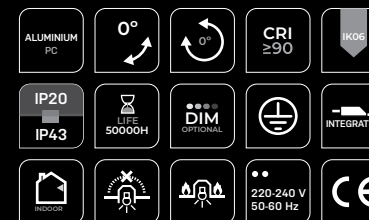

ALBA MINI

REF 10211.TR

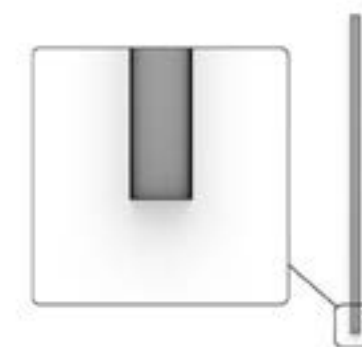

REF.	ELECTRIC SYSTEM LENGTH		FINISH	DIFFUSER	POWER	CRI	DOWNLIGHT *2 LUMEN				WATT		DIMM
	MM	MM					.27	.30	.40	.TW *1	K	TW	
10211	.03	843	●	.OP .MP	.ST	.9	2295	2385	2475	5700-5910	18	38	.DA .PU .D1
	.04	1124					3060	3180	3300	7600-7880	24	51	
	.05	1405					3825	3975	4125	9500-9850	30	64	
	.06	1686					4590	4770	4950	11400-11820	35	76	
	.07	1967					5355	5565	5775	13300-13790	41	89	
	.08	2248					6120	6360	6600	15200-15760	47	102	

REF.	ELECTRIC SYSTEM LENGTH		FINISH	DIFFUSER	POWER	CRI	DOWNLIGHT *2 LUMEN			WATT	DIMM
	MM	MM					.27	.30	.40		
10211	.03	843	●	.OP .MP	.HI	.9	4590	4767	4956	35	.DA .PU .D1
	.04	1124					6120	6356	6608	47	
	.05	1405					7650	7945	8260	59	
	.06	1686					9180	9534	9912	71	
	.07	1967					10710	11123	11564	83	
	.08	2248					12240	12712	13216	94	

Reference order | 10211.XX.TR.XX.XX.XX.XX.XX.XX.XX

Total length = Electric System Length + 25mm + 2x2mm (Cover kit)

+ Linear Joint Total length = Profile length + 25mm + [2x2mm (Cover kit)] + [N° of UR03 x 8]

Joints, other than Linear joint, require a technical drawing

(Total length + 2mm) x 35mm

70mm

● Select finish



COMPONENTS

COVER KIT	REF.	FINISH
	TF03	●
	2x2mm.	

Reference order | TF03.TR.XX

JOINTS

LINEAR JOINT	ANGLE JOINT*3	T-JOINT	CROSS JOINT	WALL-CEILING JOINT	FINISH
					●
UR03	UL03	UT03	UC03	UV03	

Reference order | XX03.TR.XX

ALBA MINI

REF 10211.TR



PHOTOMETRY

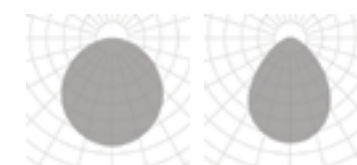

OPAL

MICROPRISMATIC

INCLUDED

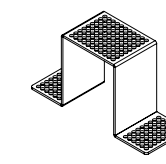

TR INSTALLATION KIT

PROFILE

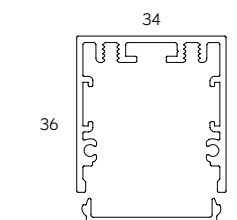

*1 Tunable White (TW) values correspond to 2700K and 6500K - TW is only available for DALI DT8 dimmable (DA), CRI 80 (8) 700mA. Los valores del blanco dinámico (TW) corresponden a 2700K y 6500K. -TW solo está disponible con protocolo DALI DT8 (DA), CRI 80 (8) 700mA.

*2 Down light (direct light) works at 500mA. La luz directa trabaja a 500mA.

*3 Miter cut diffuser. Difusor a inglete.



FINISHES

● COLORS



DIMENSIONS

◆ ELECTRIC SYSTEM LENGTH mm.

843 | 1124 | 1405 | 1686 | 1967 | 2248

LIGHTING OPTIONS

■ DIFFUSERS

OPAL | MICROPRISMATIC

POWER

STANDARD | HIGH

CRI

90

COLOR TEMPERATURE

2700K | 3000K | 4000K | TW

▼ DIMMABLE OPTIONS

DALI | 1.10 | PUSH

▲ LIGHT DISTRIBUTION

DOWN

LUMINAIRE INCLUDES

Trimless mounting kit

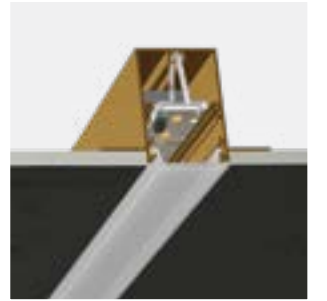
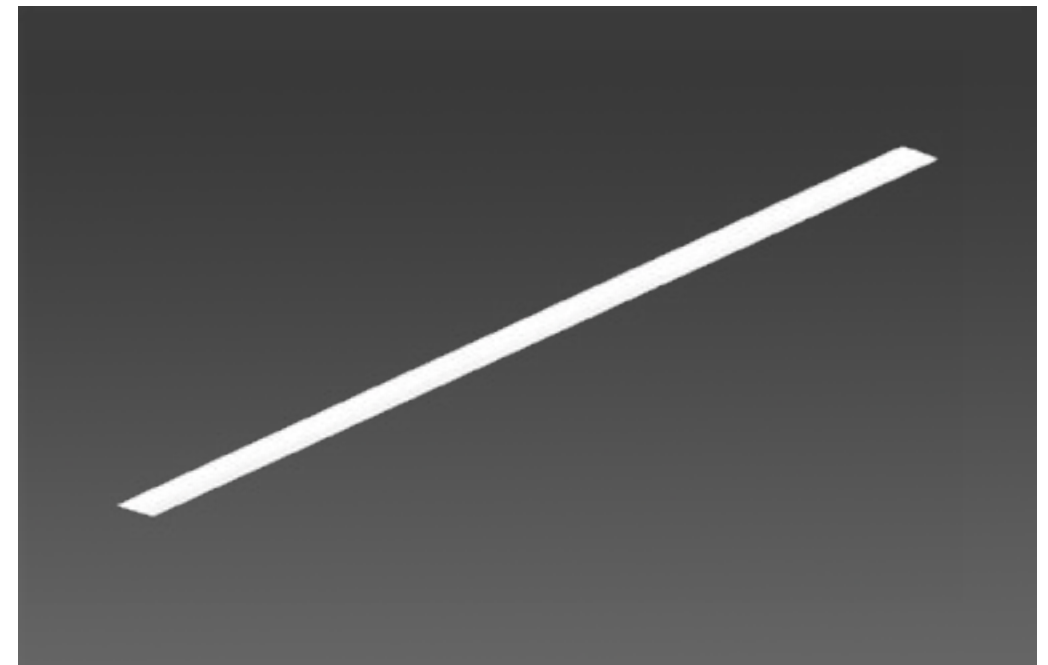

ON DEMAND

Special RAL Color
Emergency Lighting*
Motion Detection
Custom dimensions
Special Color Temperature
RGB
Thematic LED
Wireless Control Options (Casambi)
CRI 80

* Delivered separately
(not installed in luminaire).

INSTALLATIONS



ALBA

REF 10160.TR

.PN
PENDANT

·10160 ALBA | PN
Pag. 230

.WS
WALL SURFACE

·10160 ALBA | WS
Pag. 786

.TK
TRACK

·10160 ALBA | TK
Pag. 760

.SR
SURFACE

·10160 ALBA | SR
Pag. 230

.RF
RECESSED FRAME

·10160 ALBA | RF
Pag. 444

.TR
TRIMLESS

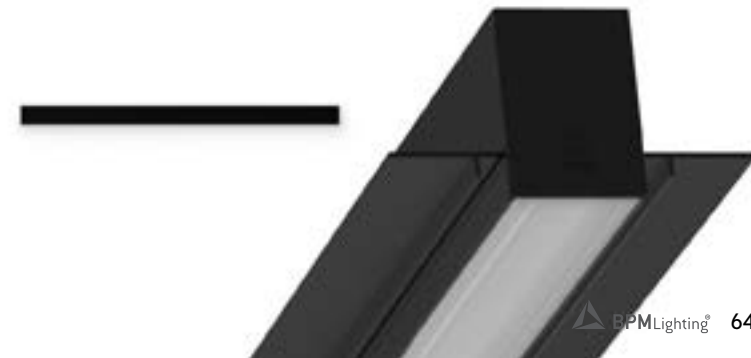
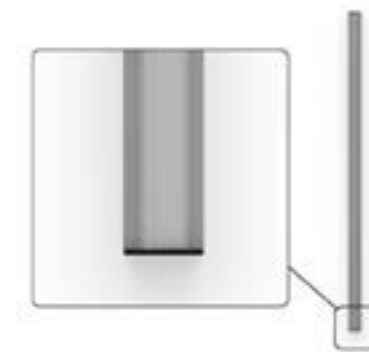

·10160 ALBA | TR
Pag. 644



REF.	ELECTRIC SYSTEM LENGTH		FINISH	DIFFUSER	POWER	CRI	DOWNLIGHT *2 LUMEN				WATT		DIMM
	MM	MM					.27	.30	.40	.TW *1	K	TW	
10160	.03	843	●	.OP .MP	.ST	.9	2295	2385	2475	5700-8520	18	38	.DA .PU .D1
	.04	1124					3060	3180	3300	7600-11360	24	51	
	.05	1405					3825	3975	4125	9500-14200	30	64	
	.06	1686					4590	4770	4950	11400-17040	35	76	
	.07	1967					5355	5565	5775	13300-19880	41	89	
	.08	2248					6120	6360	6600	15200-22720	47	102	

REF.	ELECTRIC SYSTEM LENGTH		FINISH	DIFFUSER	POWER	CRI	DOWNLIGHT *2 LUMEN			WATT		DIMM
	MM	MM					.27	.30	.40	K	TW	
10160	.03	843	●	.OP .MP	.HI	.9	4590	4767	4956	35	.DA .PU .D1	
	.04	1124					6120	6356	6608	47		
	.05	1405					7650	7945	8260	59		
	.06	1686					9180	9534	9912	71		
	.07	1967					10710	11123	11564	83		
	.08	2248					12240	12712	13216	94		

Reference order | 10160.XX.TR.XX.XX.XX.XX.XX.XX

 Total length = Electric System Length + 10mm + 2x2mm (Cover kit)
 (Total length + 2mm) x 65mm
 100mm

● Select finish



COMPONENTS





COVER KIT	REF.	FINISH
	TF02 2x2mm.	●

Reference order | TF02.TR.XX

REDUGER	REF.	POWER
	ACC.RG	.ST .HI

Reference order | ACC.RG.XX

JOINTS

LINEAR JOINT	ANGLE JOINT*3	T-JOINT	CROSS JOINT	WALL-CEILING JOINT	FINISH
					●
UR02	UL02	UT02	UX02	UV02	

Joints, other than Linear joint, require a technical drawing

Reference order | XX02.TR.XX

ALBA

REF 10160.TR

PHOTOMETRY

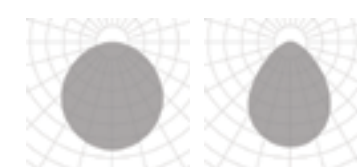

OPAL MICROPRISMATIC

PROFILE

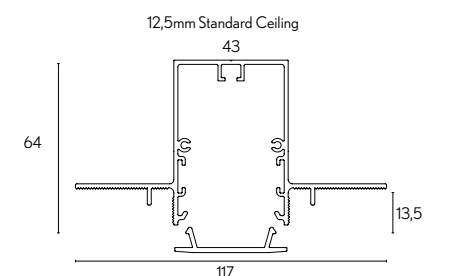

*1 Tunable White (TW) values correspond to 2700K and 6500K - TW is only available for DALI DT8 dimmable (DA), CRI 80 (8) 700mA. Los valores del blanco dinámico (TW) corresponden a 2700K y 6500K. -TW solo está disponible con protocolo DALI DT8 (DA), CRI 80 (8) 700mA.

*2 Down light (direct light) works at 500mA. La luz directa trabaja a 500mA.

*3 Miter cut diffuser. Difusor a inglete.

new



FINISHES

● EXTERNAL COLOR



INTERNAL COLOR



● ELECTRIC SYSTEM LENGTH mm.

843 | 1124 | 1405 | 1686 | 1967 | 2248

LIGHTING OPTIONS

■ DIFFUSERS

TRANSPARENT

POWER

STANDARD | HIGH

CRI

90

COLOR TEMPERATURE

2700K | 3000K | 4000K | TW

▼ DIMMABLE OPTIONS

DALI | 1.10 | PUSH

▲ LIGHT DISTRIBUTION

ASYMETRIC DOWN

LUMINAIRE INCLUDES

Trimless mounting kit

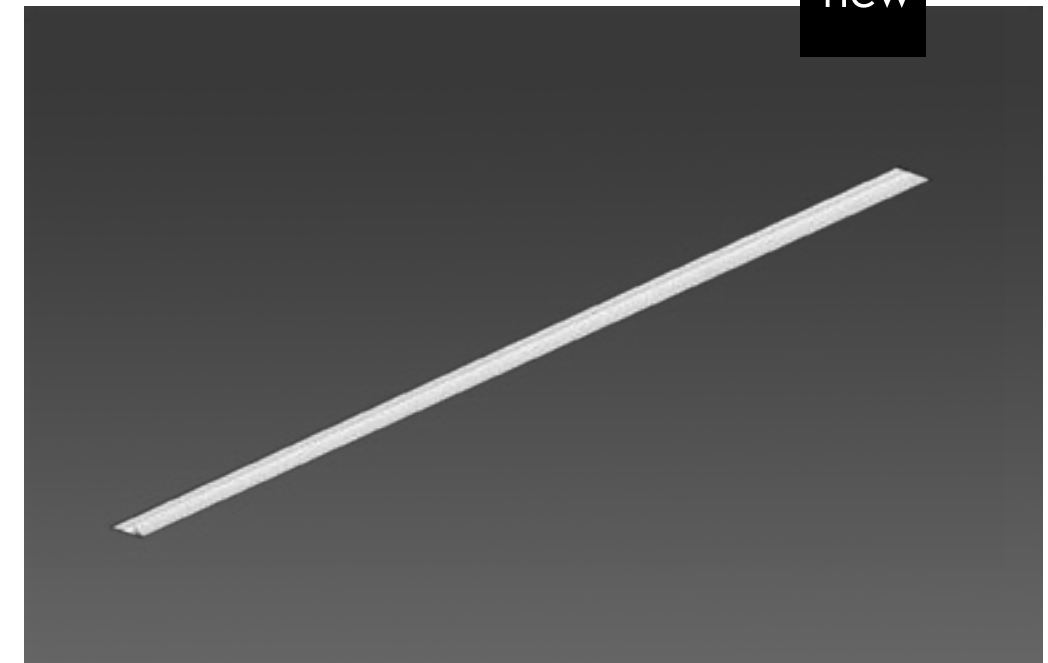

ON DEMAND

- Special RAL Color
- Emergency Lighting*
- Special Color Temperature
- RGB
- Thematic LED
- Wireless Control Options (Casambi)
- CRI 80

* Delivered separately (not installed in luminaire).

INSTALLATIONS

.PN
PENDANT

·210009 ALBA ASIMETRIC
| PN - Pag. 242

.WS
WALL SURFACE

·210009 ALBA ASIMETRIC
| WS - Pag. 794

.SR
SURFACE

·210009 ALBA ASIMETRIC
| SR - Pag. 242

.RF
RECESSED FRAME

·210009 ALBA ASIMETRIC
| RF - Pag. 448

.TR
TRIMLESS

·210009 ALBA ASIMETRIC
| TR - Pag. 648



ALBA ASIMETRIC

REF 210009.TR

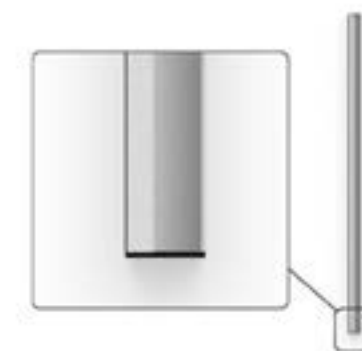



TRIMLESS

REF.	ELECTRIC SYSTEM LENGTH		FINISH	DIFFUSER	POWER	CRI	DOWNLIGHT *2 LUMEN				WATT		DIMM
	MM	MM					.27	.30	.40	.TW *1	K	TW	
210009	.03	843	●	.TP	.ST	.9	2295	2385	2475	5700-5910	18	38	.DA .PU .D1
	.04	1124					3060	3180	3300	7600-7880	24	51	
	.05	1405					3825	3975	4125	9500-9850	30	64	
	.06	1686					4590	4770	4950	11400-11820	35	76	
	.07	1967					5355	5565	5775	13300-13790	41	89	
	.08	2248					6120	6360	6600	15200-15760	47	102	

REF.	ELECTRIC SYSTEM LENGTH		FINISH	DIFFUSER	POWER	CRI	DOWNLIGHT *2 LUMEN			WATT	DIMM
	MM	MM					.27	.30	.40		
210009	.03	843	●	.TP	.HI	.9	4590	4767	4956	35	.DA .PU .D1
	.04	1124					6120	6356	6608	47	
	.05	1405					7650	7945	8260	59	
	.06	1686					9180	9534	9912	71	
	.07	1967					10710	11123	11564	83	
	.08	2248					12240	12712	13216	94	

Reference order | 210009.XX.TR.XX.XX.XX.XX.XX.XX.XX

 Total length = Electric System Length + 10mm + 2x2mm (Cover kit)
 (Total length + 2mm) x 65mm
 100mm

● Select finish



COMPONENTS

COVER KIT	REF.	FINISH
	TF06	●
	2x2mm.	

Reference order | TF06.TR.XX

JOINTS

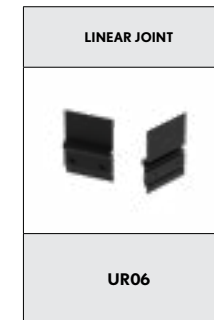

ALBA

ASIMETRIC

REF 210009.TR

PHOTOMETRY



TRANSPARENT PC

PROFILE

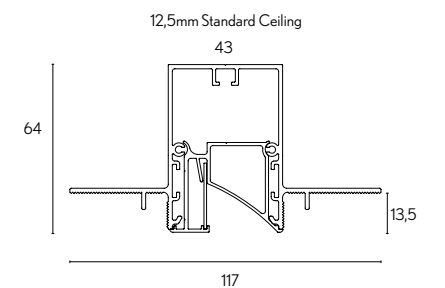

*1 Tunable White (TW) values correspond to 2700K and 6500K - TW is only available for DALI DT8 dimmable (.DA), CRI 80 (.8) 700mA. Los valores del blanco dinámico (TW) corresponden a 2700K y 6500K. -TW solo está disponible con protocolo DALI DT8 (.DA), CRI 80 (.8) 700mA.
 *2 Down light (direct light) works at 500mA. La luz directa trabaja a 500mA.



FINISHES

● COLORS



DIMENSIONS

◆ ELECTRIC SYSTEM LENGTH mm.

843 | 1124 | 1405 | 1686 | 1967 | 2248

LIGHTING OPTIONS

■ DIFFUSERS

OPAL | MICROPRISMATIC

POWER

STANDARD | HIGH

CRI

90

COLOR TEMPERATURE

2700K | 3000K | 4000K | TW

▼ DIMMABLE OPTIONS

DALI | 1.10 | PUSH

▲ LIGHT DISTRIBUTION

DOWN

LUMINAIRE INCLUDES

Trimless mounting kit

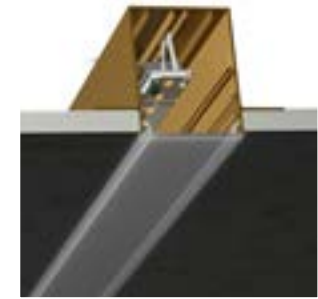
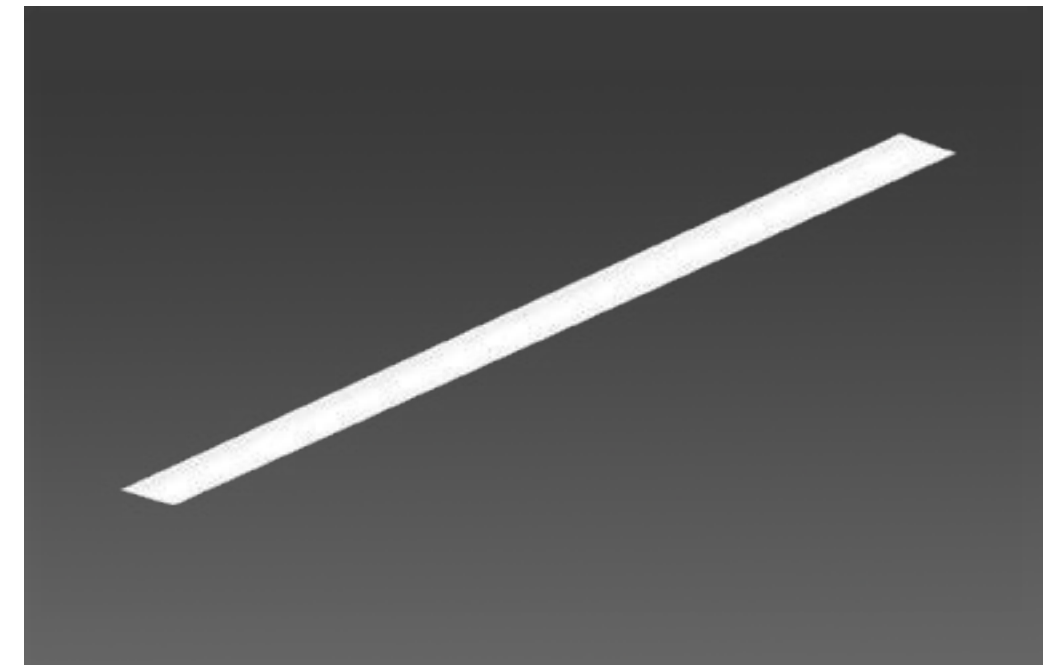

ON DEMAND

Special RAL Color
Emergency Lighting*
Motion Detection
Custom dimensions
Special Color Temperature
RGB
Thematic LED
Wireless Control Options (Casambi)
CRI 80

* Delivered separately
(not installed in luminaire).

INSTALLATIONS

.PN
PENDANT

·10178 ALBA PLUS|PN
Pag. 246

.TK
TRACK

·10178 ALBA PLUS|TK
Pag. 764

.SR
SURFACE

·10178 ALBA PLUS|SR
Pag. 246

.RF
RECESSED FRAME

·10178 ALBA PLUS|RF
Pag. 452

.TR
TRIMLESS

·10178 ALBA PLUS|TR
Pag. 652

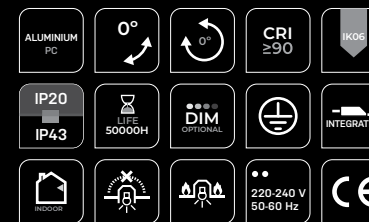

ALBA PLUS

REF 10178.TR

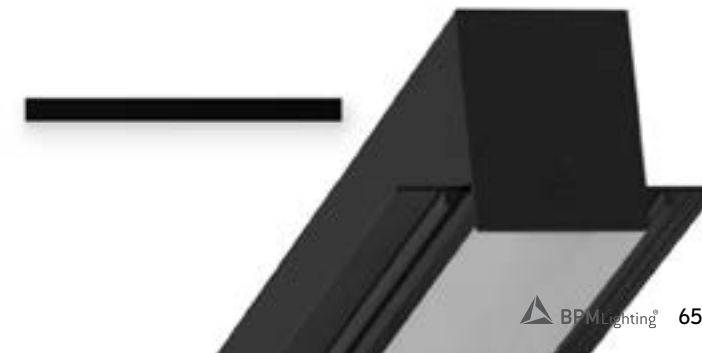
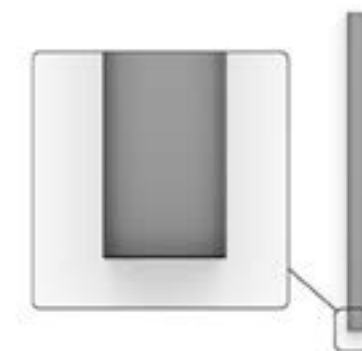



TRIMLESS

.TR

REF.	ELECTRIC SYSTEM LENGTH		FINISH	DIFFUSER	POWER	CRI	DOWNLIGHT *2 LUMEN				WATT		DIMM
	MM	MM					.27	.30	.40	.TW *1	K	TW	
10178	.03	843	●	.OP .MP	.ST	.9	2295	2385	2475	5700-8520	18	38	.DA .PU .D1
	.04	1124					3060	3180	3300	7600-11360	24	51	
	.05	1405					3825	3975	4125	9500-14200	30	64	
	.06	1686					4590	4770	4950	11400-17040	35	76	
	.07	1967					5355	5565	5775	13300-19880	41	89	
	.08	2248					6120	6360	6600	15200-22720	47	102	

REF.	ELECTRIC SYSTEM LENGTH		FINISH	DIFFUSER	POWER	CRI	DOWNLIGHT *2 LUMEN			WATT	DIMM
	MM	MM					.27	.30	.40		
10178	.03	843	●	.OP .MP	.HI	.9	4590	4767	4956	35	.DA .PU .D1
	.04	1124					6120	6356	6608	47	
	.05	1405					7650	7945	8260	59	
	.06	1686					9180	9534	9912	71	
	.07	1967					10710	11123	11564	83	
	.08	2248					12240	12712	13216	94	

Reference order | 10178.XX.TR.XX.XX.XX.XX.XX.XX.XX

 Total length = Electric System Length + 10mm + 2x1mm (Cover kit)
 (Total length + 2mm) x 85mm
 115mm

● Select finish



COMPONENTS





COVER KIT	REF.	FINISH
	TF01 2x1mm.	●

REDUGER	REF.	POWER
	ACC.RG	.ST .HI

Reference order | TF01.TR.XX

Reference order | ACC.RG.XX

JOINTS

LINEAR JOINT	ANGLE JOINT*3	T-JOINT	CROSS JOINT	WALL-CEILING JOINT	FINISH
					●
UR01	UL01	UT01	UC01	UV01	

Joints, other than Linear joint, require a technical drawing

Reference order | XX01.TR.XX

ALBA PLUS

REF 10178.TR

PHOTOMETRY

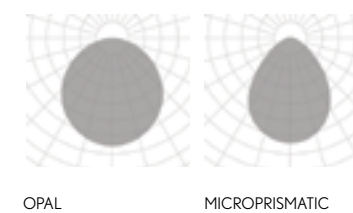

PROFILE

12,5mm Standard Ceiling

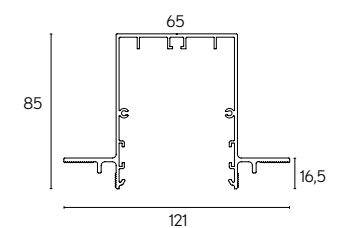

*1 Tunable White (TW) values correspond to 2700K and 6500K - TW is only available for DALI DT8 dimmable (DA), CRI 80 (8) 700mA. Los valores del blanco dinámico (TW) corresponden a 2700K y 6500K. -TW solo está disponible con protocolo DALI DT8 (DA), CRI 80 (8) 700mA.

*2 Down light (direct light) works at 500mA. La luz directa trabaja a 500mA.

*3 Miter cut diffuser. Difusor a inglete.



new

FINISHES

EXTERNAL COLOR



INTERNAL COLOR



ELECTRIC SYSTEM LENGTH mm.

843 | 1124 | 1405 | 1686 | 1967 | 2248

LIGHTING OPTIONS

DIFFUSERS

TRANSPARENT

POWER

STANDARD | HIGH

CRI

90

COLOR TEMPERATURE

2700K | 3000K | 4000K | TW

DIMMABLE OPTIONS

DALI | 1.10 | PUSH

LIGHT DISTRIBUTION

ASYMETRIC DOWN

LUMINAIRE INCLUDES

Trimless mounting kit

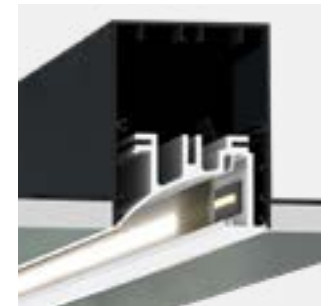
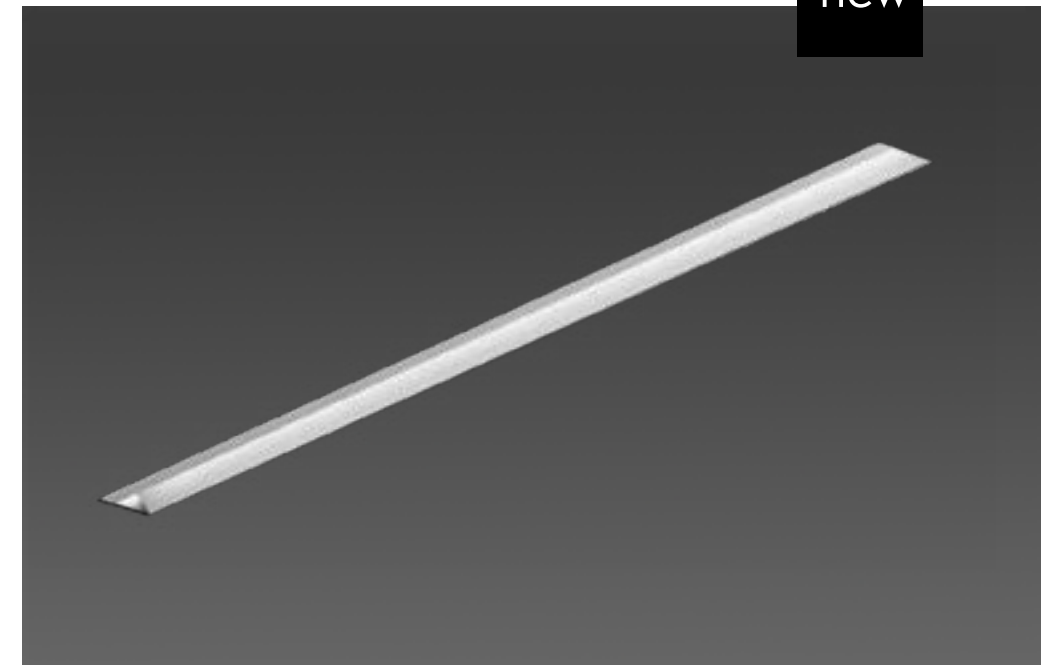

ON DEMAND

Special RAL Color
Emergency Lighting*
Custom dimensions
Special Color Temperature
RGB
Thematic LED
Wireless Control Options (Casambi)
CRI 80
Motion Detection

* Delivered separately
(not installed in luminaire).

INSTALLATIONS

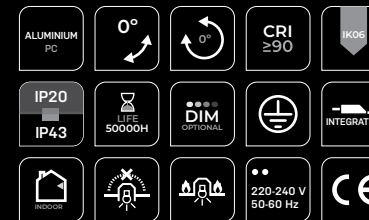

ALBA PLUS ASIMETRIC

REF 210008.TR

.PN
PENDANT

·210008 ALBA PLUS
ASIMETRIC | PN - Pag. 250

.SR
SURFACE

·210008 ALBA PLUS
ASIMETRIC | SR - Pag. 250

.RF
RECESSED FRAME

·210008 ALBA PLUS
ASIMETRIC | RF - Pag. 456

.TR
TRIMLESS

·210008 ALBA PLUS
ASIMETRIC | TR - Pag. 656

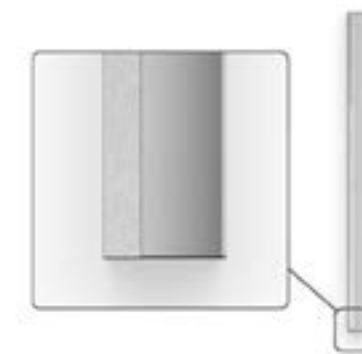



TRIMLESS

.TR

REF.	ELECTRIC SYSTEM LENGTH		FINISH	DIFFUSER	POWER	CRI	DOWNLIGHT *2 LUMEN				WATT		DIMM
	MM	MM					.27	.30	.40	.TW *1	K	TW	
210008	.03	843	●	.TP	.ST	.9	2295	2385	2475	5700-5910	18	38	.DA .PU .D1
	.04	1124					3060	3180	3300	7600-7880	24	51	
	.05	1405					3825	3975	4125	9500-9850	30	64	
	.06	1686					4590	4770	4950	11400-11820	35	76	
	.07	1967					5355	5565	5775	13300-13790	41	89	
	.08	2248					6120	6360	6600	15200-15760	47	102	

REF.	ELECTRIC SYSTEM LENGTH		FINISH	DIFFUSER	POWER	CRI	DOWNLIGHT *2 LUMEN			WATT	DIMM
	MM	MM					.27	.30	.40		
210008	.03	843	●	.TP	.HI	.9	4590	4767	4956	35	.DA .PU .D1
	.04	1124					6120	6356	6608	47	
	.05	1405					7650	7945	8260	59	
	.06	1686					9180	9534	9912	71	
	.07	1967					10710	11123	11564	83	
	.08	2248					12240	12712	13216	94	

Reference order | 210008.XX.TR.XX.XX.XX.XX.XX.XX.XX

 Total length = Electric System Length + 10mm + 2x1mm (Cover kit)
 (Total length + 2mm) x 85mm
 100mm

● Select finish



COMPONENTS

COVER KIT	REF.	FINISH
	TF05	●
	2x1mm.	

Reference order | TF05.TR.XX

JOINTS

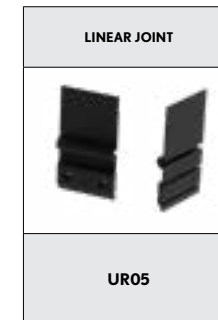

ALBA PLUS ASIMETRIC

REF 210008.TR

PHOTOMETRY



TRANSPARENT PC

PROFILE

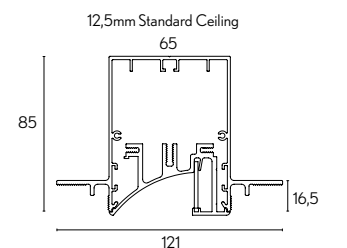

*1 Tunable White (TW) values correspond to 2700K and 6500K - TW is only available for DALI DT8 dimmable (.DA), CRI 80 (8) 700mA. Los valores del blanco dinámico (TW) corresponden a 2700K y 6500K. -TW solo está disponible con protocolo DALI DT8 (.DA), CRI 80 (8) 700mA.
 *2 Down light (direct light) works at 500mA. La luz directa trabaja a 500mA.



FINISHES

● COLORS



DIMENSIONS

◆ ELECTRIC SYSTEM LENGTH mm.

843 | 1124 | 1405 | 1686 | 1967 | 2248

LIGHTING OPTIONS

■ DIFFUSERS

OPAL | MICROPRISMATIC

POWER

STANDARD | HIGH

CRI

90

COLOR TEMPERATURE

2700K | 3000K | 4000K | TW

▼ DIMMABLE OPTIONS

DALI | 1.10 | PUSH

▲ LIGHT DISTRIBUTION

DOWN

LUMINAIRE INCLUDES

Trimless mounting kit

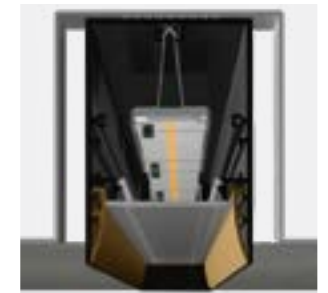
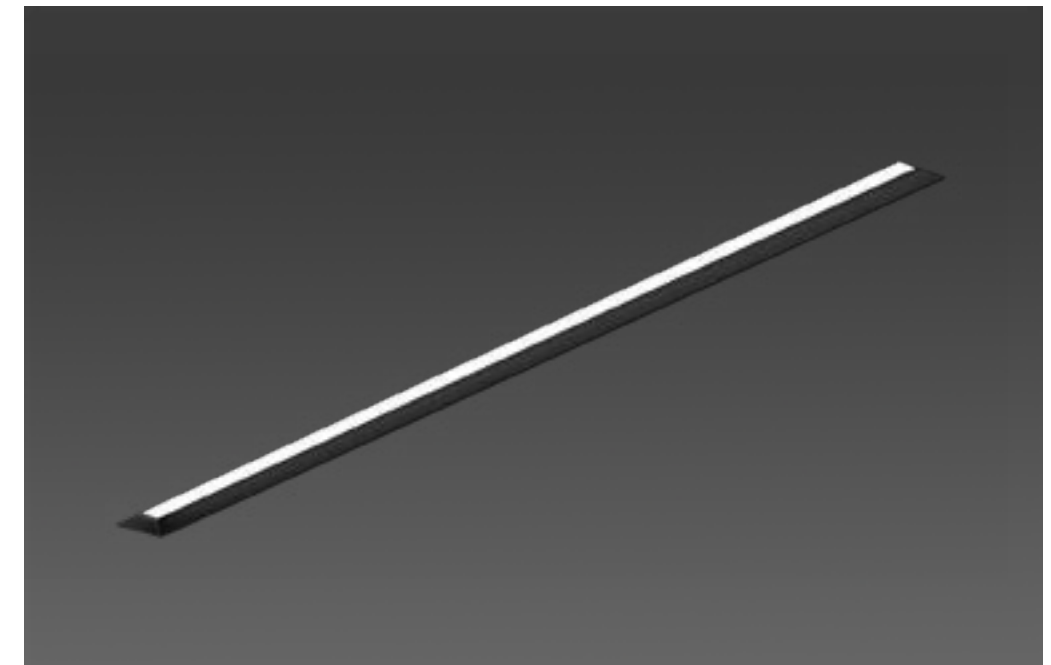

ON DEMAND

Special RAL Color
Emergency Lighting*
Motion Detection
Special Color Temperature
RGB
Thematic LED
Wireless Control Options (Casambi)
CRI 80

* Delivered separately
(not installed in luminaire).

INSTALLATIONS

.PN
PENDANT

·10200 WING|PN
Pag. 262

.SR
SURFACE

·10200 WING|SR
Pag. 262

.RF
RECESSED FRAME

·10200 WING|RF
Pag. 464

.TR
TRIMLESS

·10200 WING|TR
Pag. 660

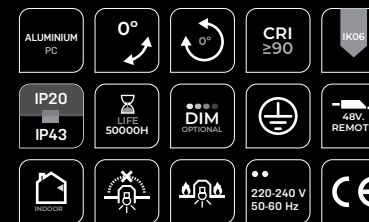

WING

REF 10200.TR

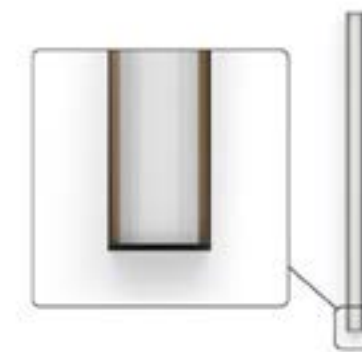



TRIMLESS

.TR

REF.	ELECTRIC SYSTEM LENGTH		FINISH	DIFFUSER	POWER	CRI	DOWNLIGHT *2 LUMEN				WATT		DIMM
	MM	MM					.27	.30	.40	.TW *1	K	TW	
10200	.03	843	●	.OP .MP	.ST	.9	2295	2385	2475	5700-5910	18	38	.DA .PU .D1
	.04	1124					3060	3180	3300	7600-7880	24	51	
	.05	1405					3825	3975	4125	9500-9850	30	64	
	.06	1686					4590	4770	4950	11400-11820	35	76	
	.07	1967					5355	5565	5775	13300-13790	41	89	
	.08	2248					6120	6360	6600	15200-15760	47	102	

REF.	ELECTRIC SYSTEM LENGTH		FINISH	DIFFUSER	POWER	CRI	DOWNLIGHT *2 LUMEN			WATT	DIMM
	MM	MM					.27	.30	.40		
10200	.03	843	●	.OP .MP	.HI	.9	4590	4767	4956	35	.DA .PU .D1
	.04	1124					6120	6356	6608	47	
	.05	1405					7650	7945	8260	59	
	.06	1686					9180	9534	9912	71	
	.07	1967					10710	11123	11564	83	
	.08	2248					12240	12712	13216	94	

Reference order | 10200.XX.TR.XX.XX.XX.X.XX.XX

 Total length = Electric System Length + 10mm + 2x2mm (Cover kit)
 (Total length + 2mm) x 58mm
 100mm

COVER KIT	REF.	FINISH
	TF13 2x2mm.	●

Reference order | TF13.TR.XX

REDUGER	REF.	POWER
	ACC.RG	.ST .HI

Reference order | ACC.RG.XX

JOINTS

LINEAR JOINT

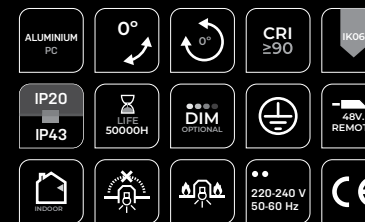
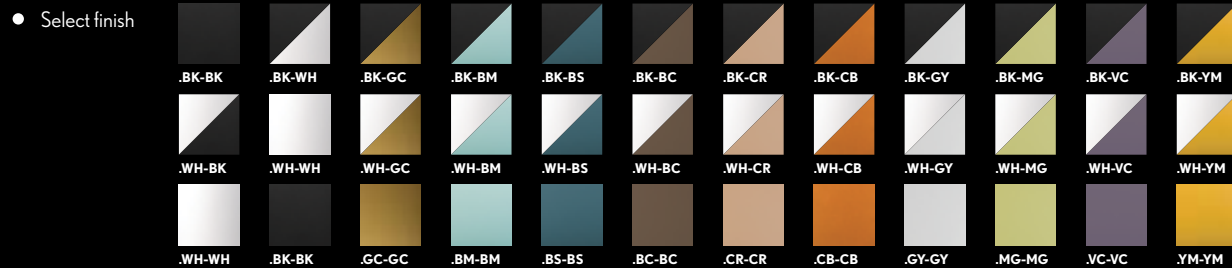
UR13



WING

REF 10200.TR

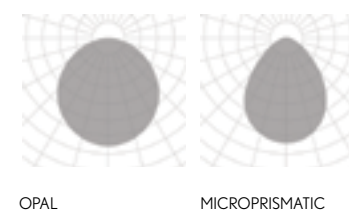
PHOTOMETRY



INCLUDED

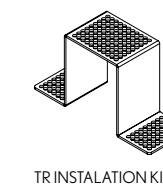

PROFILE

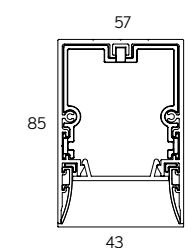

*1 Tunable White (TW) values correspond to 2700K and 6500K - TW is only available for DALI DT8 dimmable (DA), CRI 80 (8) 700mA. Los valores del blanco dinámico (TW) corresponden a 2700K y 6500K. -TW solo está disponible con protocolo DALI DT8 (DA), CRI 80 (8) 700mA.
*2 Down light (direct light) works at 500mA. La luz directa trabaja a 500mA.

Avant-garde design

Our tech lights are an opportunity for creativity, a lighting game where everyone wins, since they are design to achieve a wide range of lighting solutions.

Estética vanguardista

Son una oportunidad para la creatividad, un juego de iluminación donde todos ganan, ya que están diseñadas para lograr una amplia gama de soluciones de iluminación.



TECH

TRIMLESS

LENT MODULAR	REF.	DIMENSIONS	SHAPE	FINISHES	LAMP	OPTIC OPTIONS	POWER	CRI	K	LUMEN	WATT	mA	DIMM*	SKETCH
	10216	.01	.RD .SQ	●	LED	.20 .40 .60	.ST	.9	.27 .30 .40	142 161 212	2	700	.DA .PU .D1	
	10216	.03	.RD .SQ	●	LED	.20 .40 .60	.ST	.9	.27 .30 .40	426 483 635	6	700	.DA .PU .D1	
	10216	.05	.RD .SQ	●	LED	.20 .40 .60	.ST	.9	.27 .30 .40	710 805 1060	10	700	.DA .PU .D1	
	10216	.10	.RD .SQ	●	LED	.20 .40 .60	.ST	.9	.27 .30 .40	1420 1611 2120	20	700	.DA .PU .D1	

Reference order | 10216.XX.TR.XX.XX.XX.ST.9.XX.XX

● Select finishes

.BK-BK	.BK-WH	.BK-GC	.BK-BM	.BK-BS	.BK-BC	.BK-CR	.BK-CB	.BK-GY	.BK-MG	.BK-VC	.BK-YM
.WH-BK	.WH-WH	.WH-GC	.WH-BM	.WH-BS	.WH-BC	.WH-CR	.WH-CB	.WH-GY	.WH-MG	.WH-VC	.WH-YM

ROUND RO 26x29,3 mm Int Ø14,5 - Ext. Ø23 mm	SQUARE SQ 26x29,3 mm Ø14,5 mm

FINISHES

EXTERNAL COLOR

INTERNAL COLOR

DIMENSIONS

● View in family specifications

.01 | .03 | .05 | .10

LIGHTING OPTIONS

■ BEAM ANGLE

20° | 40° | 60°

POWER

STANDARD

CRI

90

COLOR TEMPERATURE

2700K | 3000K | 4000K

▼ DIMMABLE OPTIONS

DALI | 1.10 | PUSH

▲ LIGHT DISTRIBUTION

DOWN

ON DEMAND

Dim to Warm
Tunable White

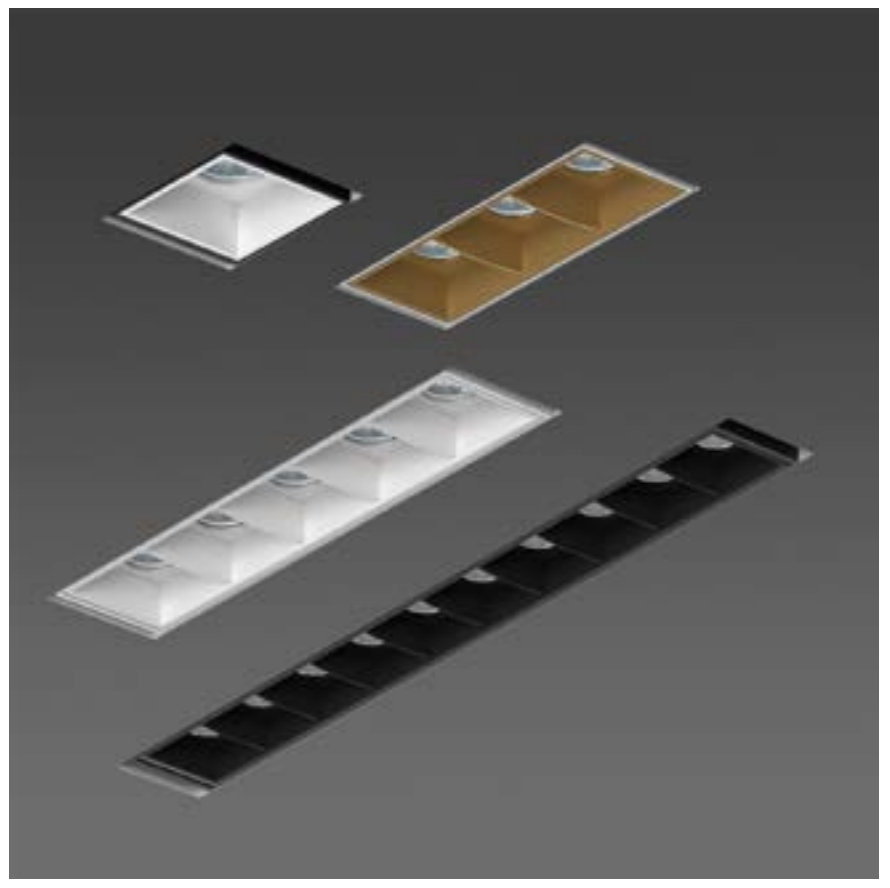

INSTALLATIONS

.RF
RECESSED FRAME

10216 LENT MODULAR | RF
Pag. 472

.TR
TRIMLESS

10216 LENT MODULAR | TR
Pag. 666

ALUMINIUM PC	0°	0°	CRI ≥90	IK05
IP20 IP23	LIFE 50000H	DIM OPTIONAL	INTEGRATED	
RECOIL		220-240 V 50-60 Hz	CE	

PHOTOMETRY

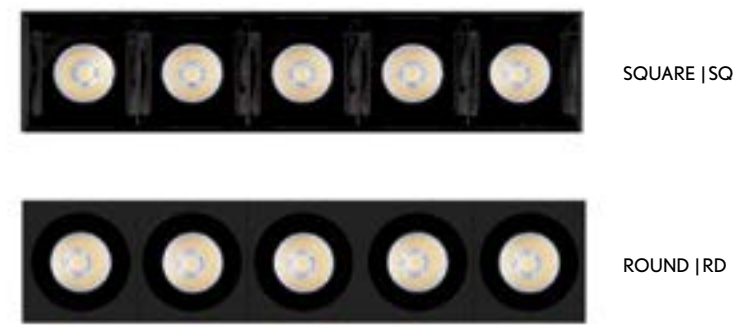
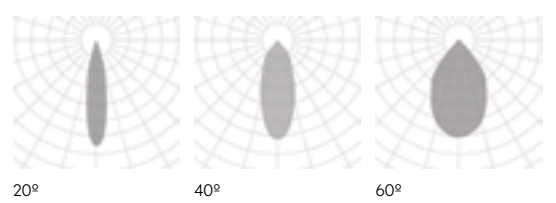

LENT MODULAR

REF 10216.TR



TRIMLESS

new

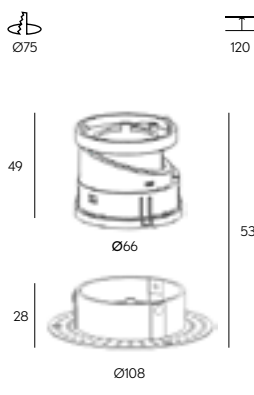
IP 65

SASSY	REF.	DIMENSIONS	FINISHES	SKETCH
	410002	.01	.WH.WH .BK-BK	

Reference order 410002.01.TR.XX

SASSYLED	REF.	DIMENSIONS	FINISHES	OPTIC OPTIONS	POWER	CRI	K	LUMEN	WATT	mA	DIMM*	SKETCH
	120001	.01	.BK-BK	.15 .26 .38 .50	.ST	.9	.27	1006	10	250	.DA .PU .D1	
							.30	1073				
							.40	1160				
							.DW	627 to 14				
					.MD	.9	.27	1548	15	350	.DA .PU .D1	
							.30	1650				
							.40	1784				
							.DW	713 to 14				
					.HI	.9	.27	2090	20	500	.DA .PU .D1	
							.30	2228				
							.40	2409				
							.DW	880 to 30				

Reference order 120001.01.BK-BK.XX.XX.X.XX.XX

FINISHES

EXTERNAL COLORS



INTERNAL COLORS



DIMENSIONS

View in family specifications

.01

LIGHTING OPTIONS

BEAM ANGLE

15° | 26° | 38° | 50°

POWER

STANDARD | MID | HI

CRI

90

COLOR TEMPERATURE

2700K | 3000K | 4000K | DW

DIMMABLE OPTIONS

DALI | 1.10 | PUSH

LIGHT DISTRIBUTION

DOWN

ON DEMAND

Dim to Warm
Tunable White



INSTALLATIONS

.RF
RECESSED FRAME

410002 SASSY | RF
Pag. 476

.TR
TRIMLESS

410002 SASSY | TR
Pag. 668



SASSY

REF 410002.TR

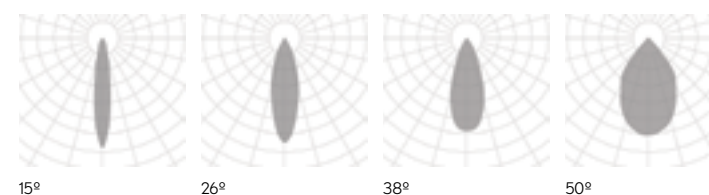

PHOTOMETRY



COMPONENTS



RING PART	FINISH
	.BK-BK .CH-CH .WH-WH .MS-MS .GF-GF
ACC410002.RR	

Reference order | ACC410002.RR.XX

RING PART			FINISH
			.BK-BK .WH-WH .BK-WH
ACC410002.TBR	ACC410002.OVR	ACC410002.CFR	

Reference order | ACC410002.XX.XX

ACCESSORIES

OVAL FLOOD LENS*1	REF.	LENSE EFFECT	SKETCH
	ACC410002.OV	.03X60	 6,4 Ø37,5
		.10X60	
		.10X40	
		.15X60	

Reference order | ACC410002.OV.XX

FLOOD LENS*1	REF.	LENSE EFFECT	SKETCH
	ACC410002	.ZSX1.3	 6,4 Ø37,5
		.ZSX1.5	
		.ZSX2	
		.ZSX3	

Reference order | ACC410002.XX

HONEYCOMB

ACC410002.HC

*1 Only compatible with ring part ACC410002.RR. Solo compatible con marco ACC410002.RR.
 Select 3 components to form your final luminaire: Sassy + Sassy LED + Ring part. Selecciona 3 componentes para formar la luminaria definitiva: Sassy + Sassy LED + Ring part.



Select finish

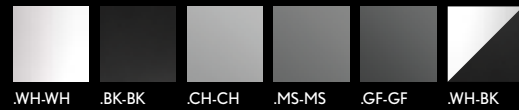

- ALUMINIUM PC
- 90°
- 350°
- CRI ≥90
- IK05
- IP20
- IP65
- LIFE 50000H
- DIM OPTIONAL
- REMOTE
- INDOOR
- 220-240 V 50-60 Hz
- CE

SASSY

REF 410002.TR

TRIMLESS

SASSY SQ	REF.	DIMENSIONS	FINISHES	SKETCH
	410003	.01	●	

Reference order **410003.01.TR.XX**

SASSY LED	REF.	DIMENSIONS	FINISHES	OPTIC OPTIONS	POWER	CRI	K	LUMEN	WATT	mA	DIMM*	SKETCH
	120001	.01	.BK-BK	.15 .26 .38 .50	.ST	.9	.27	1006	10	250	.DA .PU .D1	
							.30	1073				
							.40	1160				
					.DW	.9	.27	1548	15	350	.DA .PU .D1	
							.30	1650				
							.40	1784				
					.DW	.9	.27	627 to 14	6	350 to 14	.DA	
							.30	1548	7	420 to 14	.DA	
							.40	1784				
					.DW	.9	.27	2090				
							.30	2228				
							.40	2409				
.DW	.9	.27	880 to 30	10	280 to 14	.DA						
		.30	2228									
		.40	2409									

Reference order **120001.01.BK-BK.XX.XX.XXX.XX.XX**

FINISHES

EXTERNAL COLORS



INTERNAL COLORS



DIMENSIONS

View in family specifications

.01 |

LIGHTING OPTIONS

BEAM ANGLE

15° | 26° | 38° | 50°

POWER

STANDARD | MID | HI

CRI

90

COLOR TEMPERATURE

2700K | 3000K | 4000K | DW

DIMMABLE OPTIONS

DALI | 1.10 | PUSH

LIGHT DISTRIBUTION

DOWN

ON DEMAND

Dim to Warm
Tunable White



INSTALLATIONS

.RF
RECESSED FRAME

·410003 SASSY SQ | RF
Pag. 482

.TR
TRIMLESS

·410003 SASSY SQ | TR
Pag. 672

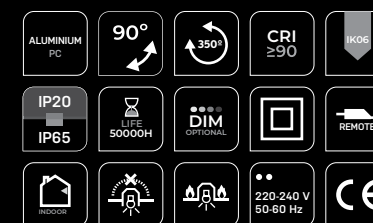

SASSY SQ

REF 410003.TR

PHOTOMETRY

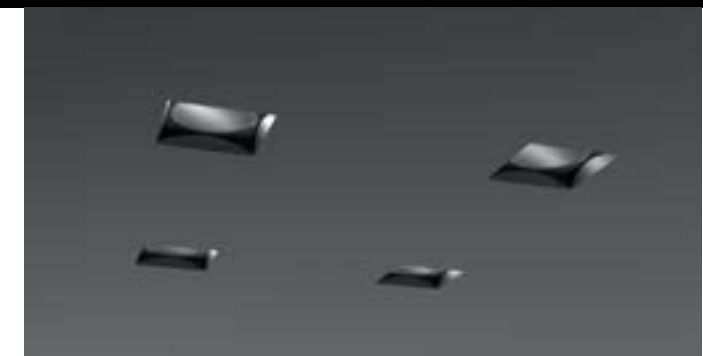
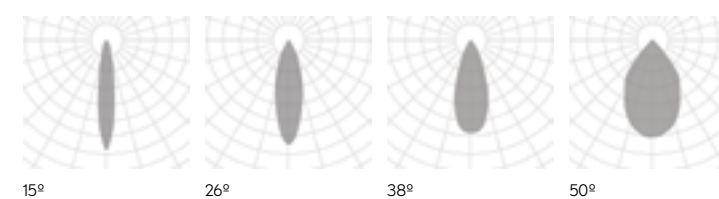





TRIMLESS





COMPONENTS

RING PART	FINISH
	.BK-BK .CH-CH .WH-WH .MS-MS .GF-GF
ACC410003.SQR	

Reference order | ACC410003.SQR.XX

ACCESORIES

OVAL FLOOD LENS	REF.	LENSE EFFECT	SKETCH
	ACC410003.OV	.03X60	 6,4 Ø37,5
		.10X60	
		.10X40	
		.15X60	

FLOOD LENS	REF.	LENSE EFFECT	SKETCH
	ACC410003	.ZSX1.3	 6,4 Ø37,5
		.ZSX1.5	
		.ZSX2	
		.ZSX3	

HONEYCOMB

ACC410003.HC

Reference order | ACC410003.OV.XX

Reference order | ACC410003.XX

Select 3 components to form your final luminaire: Sassy SQ + Sassy LED + Ring part. Selecciona 3 componentes para formar la luminaria definitiva: Sassy SQ + Sassy LED + Ring part.



• Select finish

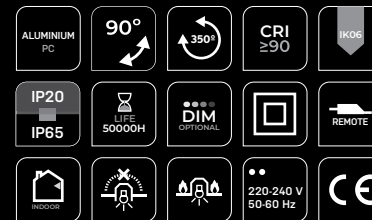

SASSY SQ

REF 410003.TR

.TR

TRIMLESS

MARTORELL	REF.	DIMENSIONS	FINISHES	LAMP	OPTIC OPTIONS	POWER	CRI	K	LUMEN	WATT	mA	DIMM*	SKETCH
	20115	.01	.WH-WH .BK-BK	LED	.15 .24 .32	.ST	.9	.27 .30 .40	175 188 199	3	700	.DA .PU .D1	
	20115	.02	●	LED	.15 .24 .32	.ST	.9	.27 .30 .40	470 498 515	8	700	.DA .PU .D1	
	20115	.03	●	LED	.24 .32 .43	.ST	.9	.27 .30 .40	1071 1156 1198	12	500	.DA .PU .D1	

Reference order | 20115.XX.TR.XX.XX.ST.9.XX.XX

Select finishes

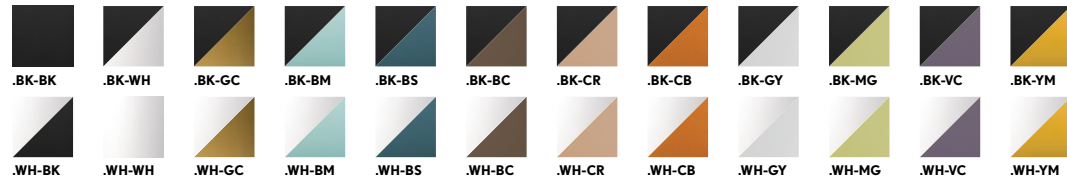

* Dimm options require the combination of a minimum of 2 luminaires. Las opciones de regulación necesitan la combinación de un mínimo de 2 luminarias.

FINISHES

EXTERNAL COLOR



INTERNAL COLOR



DIMENSIONS

View in family specifications

.01 | .02 | .03

LIGHTING OPTIONS

BEAM ANGLE

15° | 24° | 32° | 43°

POWER

STANDARD

CRI

90

COLOR TEMPERATURE

2700K | 3000K | 4000K

DIMMABLE OPTIONS

DALI | 1.10 | PUSH

LIGHT DISTRIBUTION

DOWN

ON DEMAND

Dim to Warm (.02, .03)
Tunable White (.02, .03)
Honey Comb (.03)
Wireless Control Options
Special RAL Color

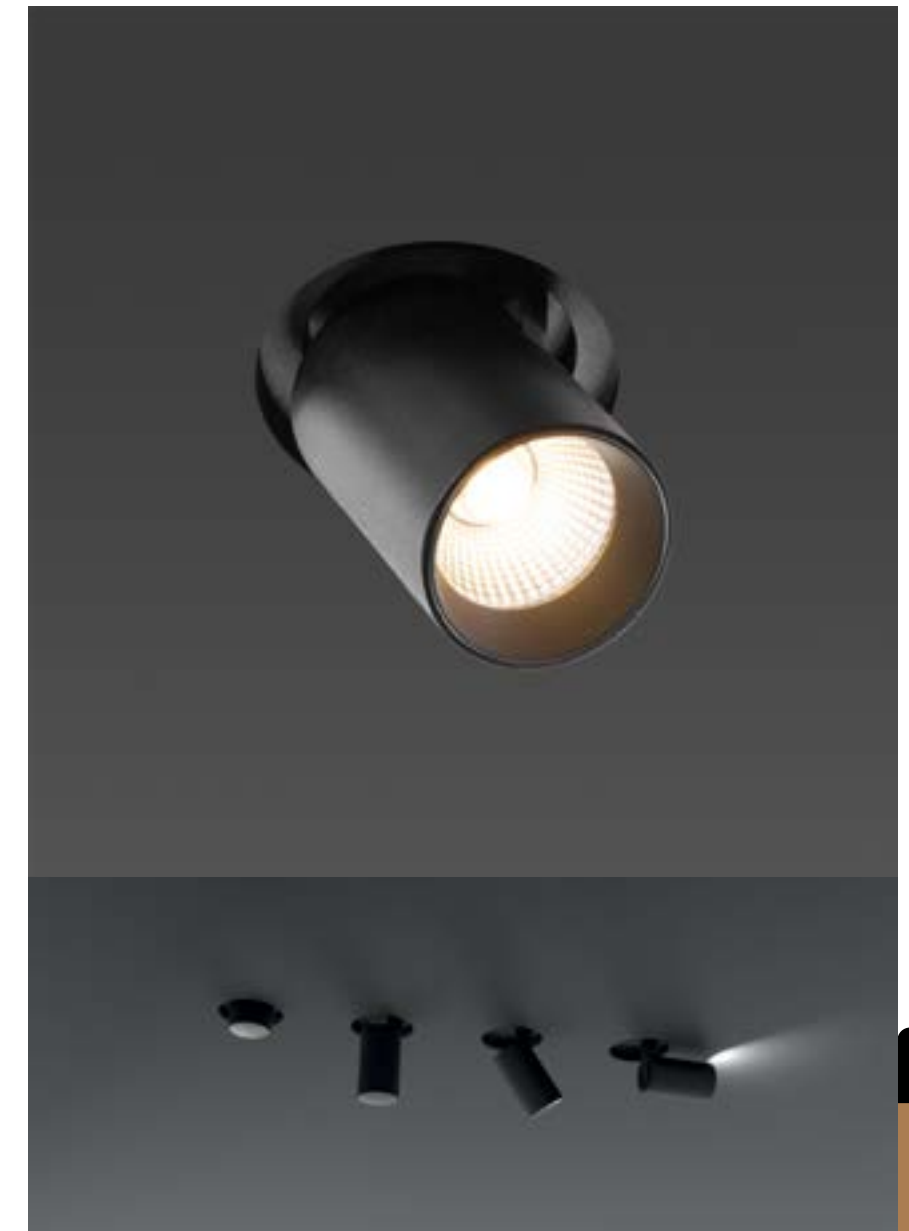

INSTALLATIONS

.PN
PENDANT

·20115 MARTORELL | PN
Pag. 322

.TK
TRACKLIGHT

·20115 MARTORELL | TK
Pag. 744

.SR
SURFACE

·20115 MARTORELL | SR
Pag. 322

.RF
RECESSED FRAME

·20115 MARTORELL | RF
Pag. 494

.TR
TRIMLESS

·20115 MARTORELL | TR
Pag. 676

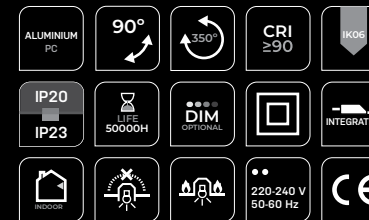

PHOTOMETRY

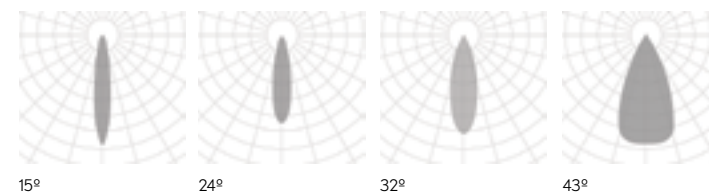

MARTORELL

REF 20115.TR

TRIMLESS

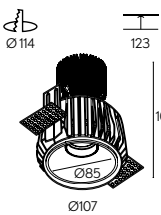
MARTORELL TÁRREGA	REF.	DIMENSIONS	FINISHES	LAMP	OPTIC OPTIONS	POWER	CRI	K	LUMEN	WATT	mA	DIMM*	SKETCH
	20117	.01	●	LED	.25 .30	.ST	.9	.27	659	10	500	.DA .PU .D1	
								.30	691				
								.40	719				

Reference order  20117.01.TR.XX.XX.ST9.XX.XX

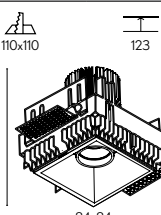
MARTORELL TÁRREGA SQ	REF.	DIMENSIONS	FINISHES	LAMP	OPTIC OPTIONS	POWER	CRI	K	LUMEN	WATT	mA	DIMM*	SKETCH
	20116	.01	●	LED	.25 .30	.ST	.9	.27	659	10	500	.DA .PU .D1	
								.30	691				
								.40	719				

Reference order  20116.01.TR.XX.XX.ST9.XX.XX

Select finishes

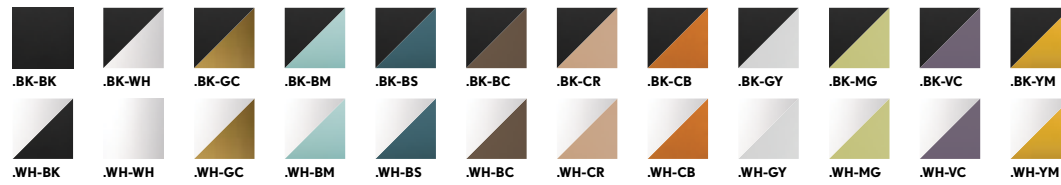

FINISHES

EXTERNAL COLOR



INTERNAL COLOR



DIMENSIONS

View in family specifications

.01

LIGHTING OPTIONS

BEAM ANGLE

25° | 30°

POWER

STANDARD

CRI

90

COLOR TEMPERATURE

2700K | 3000K | 4000K

DIMMABLE OPTIONS

DALI | 1.10 | PUSH

LIGHT DISTRIBUTION

DOWN

ON DEMAND

Dim to Warm
Tunable White



INSTALLATIONS

.RF
RECESSED FRAME

.20117 TARREGA | RF .20116 TARREGA SQ | RF
Pag. 498

.TR
TRIMLESS

.20117 TARREGA | TR .20116 TARREGA SQ | TR
Pag. 678



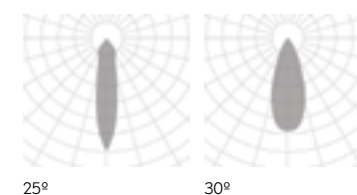

PHOTOMETRY



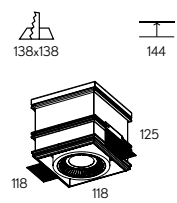

MARTORELL TÁRREGA | TÁRREGA SQ

REF 20117.TR | 20116.TR

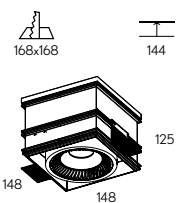
TRIMLESS

LUK FREIR	REF.	DIMENSIONS	FINISHES	LAMP	OPTIC OPTIONS	POWER	CRI	K	LUMEN	WATT	mA	DIMM*	SKETCH
	20018	.01	●	LED	.40 .60	.ST	.9	.27	830	10	350	.DA .PU .D1	
								.30	845				
								.40	895				
	20018	.02	●	LED	.40 .60	.ST	.9	.27	1271	18	500	.DA .PU .D1	
								.30	1616				
								.40	1682				

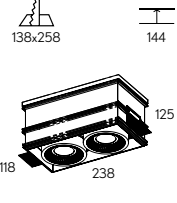
Reference order **20018XX.TR.XX.XX.ST9.XX.XX**

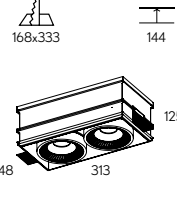
LUK FREIR 2	REF.	DIMENSIONS	FINISHES	LAMP	OPTIC OPTIONS	POWER	CRI	K	LUMEN	WATT	mA	DIMM*	SKETCH
	20019	.01	●	LED	.40 .60	.ST	.9	.27	1660	21	350	.DA .PU .D1	
								.30	1690				
								.40	1790				
	20019	.02	●	LED	.40 .60	.ST	.9	.27	1271	32	500	.DA .PU .D1	
								.30	1616				
								.40	1682				

Reference order **20019.XX.TR.XX.XX.ST9.XX.XX**

● Select finishes



FINISHES

COLORS



DIMENSIONS

● View in family specifications

.01 | .02

LIGHTING OPTIONS

■ BEAM ANGLE

40° | 60°

POWER

STANDARD

CRI

90

COLOR TEMPERATURE

2700K | 3000K | 4000K

▼ DIMMABLE OPTIONS

DALI | 1.10 | PUSH

▲ LIGHT DISTRIBUTION

DOWN

ON DEMAND

Dim to Warm
Tunable White
Wireless Control Options



INSTALLATIONS

.SR
SURFACE

·20018 LUK FREIR ·20019 LUK FREIR 2 | SR
Pag. 344

.RF
RECESSED FRAME

·20018 LUK FREIR ·20019 LUK FREIR 2 | RF
Pag. 514

.TR
TRIMLESS

·20018 LUK FREIR ·20019 LUK FREIR 2 | TR
Pag. 680



PHOTOMETRY

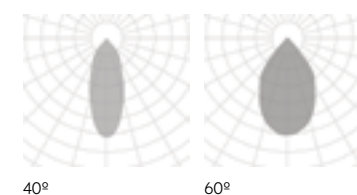

LUK FREIR | FREIR 2

REF 20018.TR | REF 20019.TR

.TR

TRIMLESS

CUBE SQ	REF.	DIMENSIONS	FINISHES	LAMP	OPTIC OPTIONS	POWER	CRI	K	LUMEN	WATT	mA	DIMM*	SKETCH
	8201	.01	●	LED	.24 .40 .60	.ST	.9	.27	738	11	350	.DA .PU .D1	
								.30	862				
								.40	929				

Reference order | 8201.01.TR.XX.XX.ST9.XX.XX

CUBE SQ2	REF.	DIMENSIONS	FINISHES	LAMP	OPTIC OPTIONS	POWER	CRI	K	LUMEN	WATT	mA	DIMM*	SKETCH
	8202	.01	●	LED	.24 .40 .60	.ST	.9	.27	1476	22	350	.DA .PU .D1	
								.30	1724				
								.40	1858				

Reference order | 8202.01.TR.XX.XX.ST9.XX.XX

CUBE SQ3	REF.	DIMENSIONS	FINISHES	LAMP	OPTIC OPTIONS	POWER	CRI	K	LUMEN	WATT	mA	DIMM*	SKETCH
	8203	.01	●	LED	.24 .40 .60	.ST	.9	.27	2214	33	350	.DA .PU .D1	
								.30	2586				
								.40	2787				

Reference order | 8203.01.TR.XX.XX.ST9.XX.XX

● Select external - internal finishes

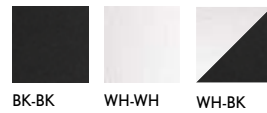

FINISHES

EXTERNAL COLOR



INTERNAL COLOR



DIMENSIONS

● View in family specifications

.01 | .02

LIGHTING OPTIONS

■ BEAM ANGLE

24° | 40° | 60°

POWER

STANDARD

CRI

90

COLOR TEMPERATURE

2700K | 3000K | 4000K

▼ DIMMABLE OPTIONS

DALI | 1.10 | PUSH

▲ LIGHT DISTRIBUTION

DOWN

ON DEMAND

Dim to Warm
Tunable White
Wireless Control Options



INSTALLATIONS

.SR
SURFACE

·8201 CUBE ·8202 CUBE 2 ·8203 CUBE 3 | SR
Pag. 354

.RF
RECESSED FRAME

·8201 CUBE ·8202 CUBE 2 ·8203 CUBE 3 | RF
Pag. 518

.TR
TRIMLESS

·8201 CUBE ·8202 CUBE 2 ·8203 CUBE 3 | TR
Pag. 682



PHOTOMETRY

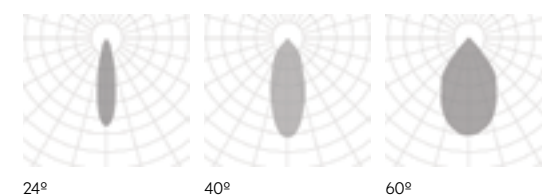

CUBE

SQ | SQ2 | SQ3

REF 8201.TR | REF 8202.TR | REF 8203.TR

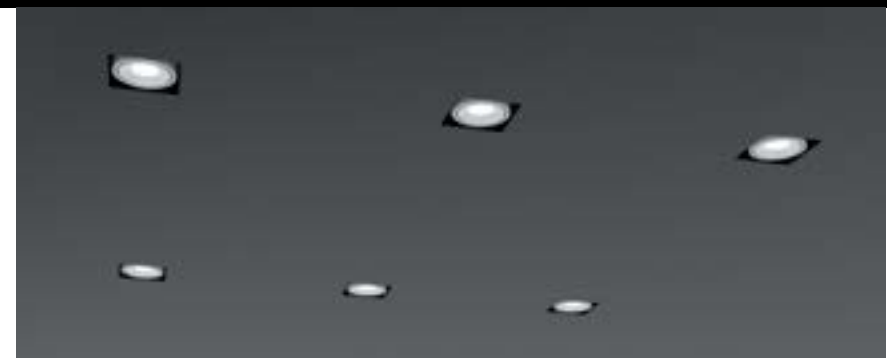

CUBE SQ	REF.	DIMENSIONS	FINISHES	LAMP	OPTIC OPTIONS	POWER	CRI	K	LUMEN	WATT	mA	DIMM*	SKETCH
	8201	.02	●	LED	.24 .40 .60	.ST	.9	.27	1661	19	500	.DA .PU .D1	
								.30	1819				
								.40	1837				

Reference order | 8201.02.TR.XX.XX.ST9.XX.XX

CUBE SQ2	REF.	DIMENSIONS	FINISHES	LAMP	OPTIC OPTIONS	POWER	CRI	K	LUMEN	WATT	mA	DIMM*	SKETCH
	8202	.02	●	LED	.24 .40 .60	.ST	.9	.27	3322	38	500	.DA .PU .D1	
								.30	3638				
								.40	3674				

Reference order | 8202.02.TR.XX.XX.ST9.XX.XX

CUBE SQ3	REF.	DIMENSIONS	FINISHES	LAMP	OPTIC OPTIONS	POWER	CRI	K	LUMEN	WATT	mA	DIMM*	SKETCH
	8203	.02	●	LED	.24 .40 .60	.ST	.9	.27	4983	58	500	.DA .PU .D1	
								.30	5457				
								.40	5511				

Reference order | 8203.02.TR.XX.XX.ST9.XX.XX

● Select external - internal finishes

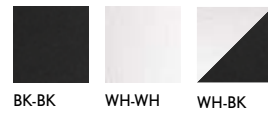

FINISHES

EXTERNAL COLOR



INTERNAL COLOR



DIMENSIONS

● View in family specifications

.01 | .02

LIGHTING OPTIONS

■ BEAM ANGLE

24° | 40° | 60°

POWER

STANDARD

CRI

90

COLOR TEMPERATURE

2700K | 3000K | 4000K

▼ DIMMABLE OPTIONS

DALI | 1.10 | PUSH

▲ LIGHT DISTRIBUTION

DOWN

ON DEMAND

Dim to Warm
Tunable White
Wireless Control Options



INSTALLATIONS

.SR
SURFACE

·8201 CUBE ·8202 CUBE 2 ·8203 CUBE 3 | SR
Pag. 354

.RF
RECESSED FRAME

·8201 CUBE ·8202 CUBE 2 ·8203 CUBE 3 | RF
Pag. 518

.TR
TRIMLESS

·8201 CUBE ·8202 CUBE 2 ·8203 CUBE 3 | TR
Pag. 682



PHOTOMETRY

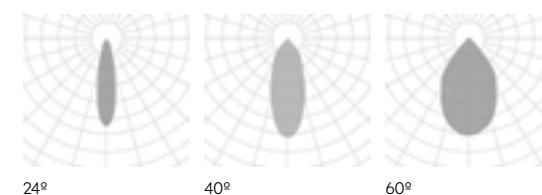

CUBE

SQ | SQ2 | SQ3

REF 8201.TR | REF 8202.TR | REF 8203.TR



The invisible star

El protagonista invisible

Style your spaces with even, harmonious light, where luminaries go virtually unnoticed. That's the secret of success of Structural / Crismosil. Say goodbye to wall lights, joins and superfluous items and let the light take centre stage.

Conseguir ambientes con una perfecta luz difusa, armoniosa, obviando la visibilidad de las luminarias. Así consigue Structural / Crismosil su objetivo. Se prescinde de apliques, juntas y todo lo superfluo para dar todo el protagonismo a la luz.



STRUCTURAL

TRIMLESS

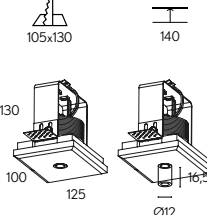
VITA	REF.	DIMENSIONS	FINISHES	LAMP	OPTIC OPTIONS	POWER	CRI	K	LUMEN	WATT	mA	DIMM	SKETCH
	30007	.01	.WH-WH	LED	.15 .40	.ST	.9	.30	153	5	250	-	
								.40	175				

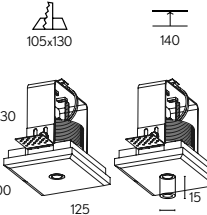
VITA	REF.	DIMENSIONS	FINISHES	LAMP	OPTIC OPTIONS	POWER	CRI	K	LUMEN	WATT	mA	DIMM	SKETCH
	30007	.02	.WH-WH	LED	.25 .40	.ST	.9	.30	504	10	600	-	
								.40	545				

10 - 20 mm ↑ * Espesor del falso techo
Ceiling thickness

LUMINAIRE INCLUDES

Recessed with frame mounting kit

Reference order **30007.XX.TR.WH-WH.XX.ST9.XX**

FINISHES

DIMENSIONS

.01 | .02

LIGHTING OPTIONS

BEAM ANGLE

15° | 25° | 40°

POWER

STANDARD

CRI

90

COLOR TEMPERATURE

2700K | 3000K | 4000K

DIMMABLE OPTIONS

LIGHT DISTRIBUTION

DOWN



CRISMOSIL

TRIMLESS

- CRISMOSIL
- 0°
- 0°
- CRI ≥90
- IP20
- IP23
- LIFE 50000H
- DIM OPTIONAL
- INTEGRATED
- RECESSED
- RECESSED
- 220-240 V 50-60 Hz
- CE

VITA

REF 30007.TR

PHOTOMETRY

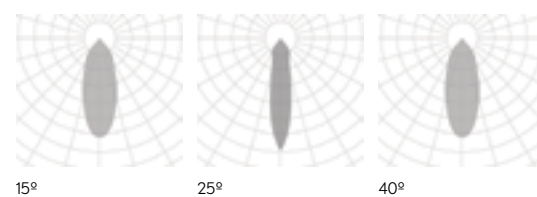

15° 25° 40°

VOLCANO	REF.	DIMENSIONS	FINISHES	LAMP	DIFFUSER	POWER	CRI	K	LUMEN	WATT	mA	DIMM	SKETCH	
	10062	.01	.WH-WH	GU5.3		GU5.3	.9	-	526	Max 8	-	-		
				GU10	.GU	GU10								
	10062	.01	.WH-WH	LED	.OP	.ST	.9	.27	526	8	350	-	.DA .PU .D1	
						.30		570						
						.27		711						
						.30		927						
						.HI		.40	767					

VOLCANO	REF.	DIMENSIONS	FINISHES	LAMP	DIFFUSER	POWER	CRI	K	LUMEN	WATT	mA	DIMM	SKETCH
	10062	.02	.WH-WH	LED	.OP	.ST	.9	.27	1538	16	500	.DA .PU .D1	
								.30	1722				
								.40	1355				

VOLCANO	REF.	DIMENSIONS	FINISHES	LAMP	DIFFUSER	POWER	CRI	K	LUMEN	WATT	mA	DIMM	SKETCH								
	10062	.03*	.WH-WH	LED	.OP	.ST	.9	.27	3280	23	500	.DA .PU .D1									
								.30	3480												
								.40	3640												
															.HI		.27	6560	47	500	
																	.30	6920			
																	.40	7269			

10-20 mm ↑ .01 .02 Espesor del falso techo
Ceiling thickness

12,5 mm ↑ .03 Espesor del falso techo
Ceiling thickness

Con difusor opal.
With opal optic cover.

* .03 is Class I - .03 es Clase I.

LUMINAIRE INCLUDES

Recessed with frame mounting kit

Reference order

10062.XX.TR.WH-WH.XX.XX.X.XX.XX

FINISHES



DIMENSIONS

.01 | .02 | .03

LIGHTING OPTIONS

DIFFUSER

OPAL

POWER

STANDARD | HIGH

CRI

90

COLOR TEMPERATURE

2700K | 3000K | 4000K

DIMMABLE OPTIONS

DALI | 1.10 | PUSH

LIGHT DISTRIBUTION

DOWN



CRISMOSIL

.TR

TRIMLESS

VOLCANO

REF 10062.TR

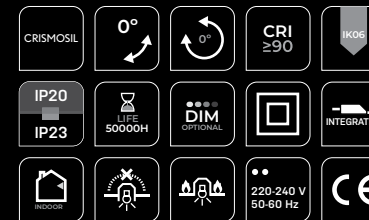

PHOTOMETRY

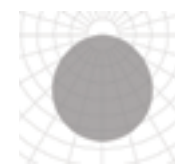

OPAL

VOLCANO DEEP	REF.	DIMENSIONS	FINISHES	LAMP	DIFFUSER	POWER	CRI	K	LUMEN	WATT	mA	DIMM	SKETCH
	10063	.01	.WH-WH	GU5.3		GU5.3	.9	.27	526	Max 8	350	.DA .PU .D1	
				GU10	.GU	GU10			570				
	10063	.01	.WH-WH	LED	.OP	.ST BPM50	.9	.27	526	8	350	.DA .PU .D1	
									570				
									711				
									707				
	10063	.01	.WH-WH	LED	.OP	.HI BPM300	.9	.30	927	10	500	.DA .PU .D1	
									767				

VOLCANO DEEP	REF.	DIMENSIONS	FINISHES	LAMP	DIFFUSER	POWER	CRI	K	LUMEN	WATT	mA	DIMM	SKETCH
	10063	.02	.WH-WH	LED	.OP	.ST BPM3181	.9	.27	1538	16	500	.DA .PU .D1	
									1722				
									1355				

VOLCANO DEEP	REF.	DIMENSIONS	FINISHES	LAMP	DIFFUSER	POWER	CRI	K	LUMEN	WATT	mA	DIMM	SKETCH
	10063	.03*	.WH-WH	LED	.OP	.ST	.9	.27	3280	23	500	.DA .PU .D1	
									3480				
									3640				
									6560				
									6920				
	10063	.03*	.WH-WH	LED	.OP	.HI	.9	.30	6920	47	500	.DA .PU .D1	
									7269				

10-20 mm **.01 .02** Espesor del falso techo
Ceiling thickness

12,5 mm **.03** Espesor del falso techo
Ceiling thickness

Con difusor opal.
With opal optic cover.
* .03 is Class I - .03 es Clase I.

LUMINAIRE INCLUDES

Recessed with frame mounting kit

Reference order

10063.XX.TR.WH-WH.XX.XX.X.XX.XX

FINISHES

DIMENSIONS

.01 | .02 | .03

LIGHTING OPTIONS

DIFFUSER

OPAL

POWER

STANDARD | HIGH

CRI

90

COLOR TEMPERATURE

2700K | 3000K | 4000K

DIMMABLE OPTIONS

DALI | 1.10 | PUSH

LIGHT DISTRIBUTION

DOWN

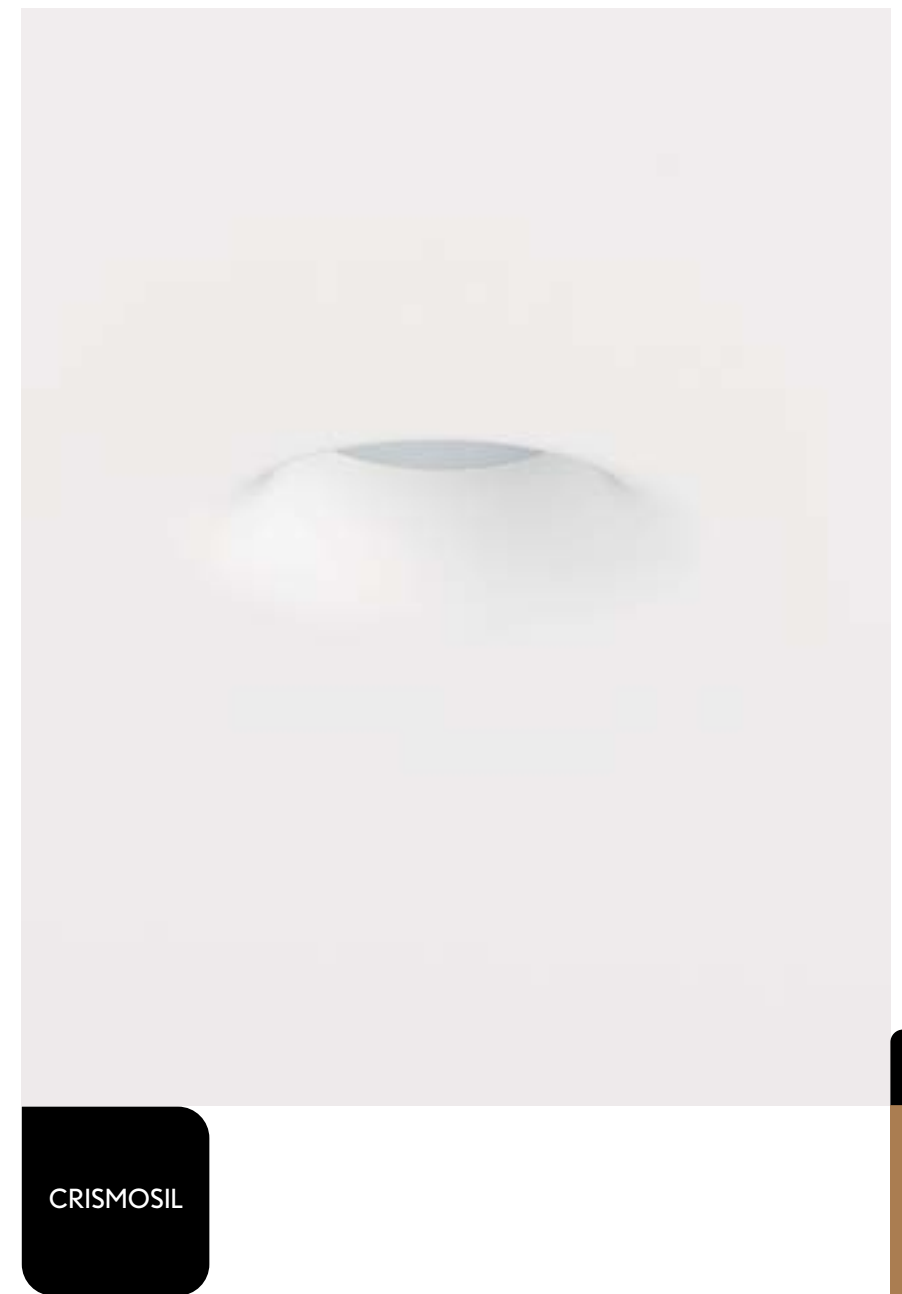

CRISMOSIL

.TR

TRIMLESS

VOLCANO DEEP

REF 10063.TR

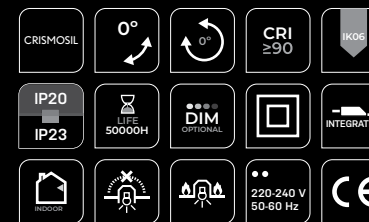

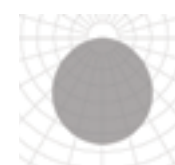

PHOTOMETRY

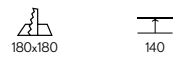
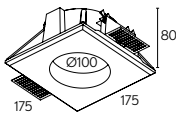

OPAL

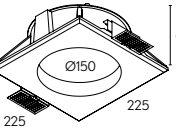
ESPIGA	REF.	DIMENSIONS	FINISHES	LAMP	DIFFUSER	POWER	CRI	K	LUMEN	WATT	mA	DIMM	SKETCH									
	10086	.01	.WH-WH	GU5.3	.GU	GU5.3	.9	-	526	Max 8	-	-										
				GU10		GU10																
				LED	.OP	.ST								.27	526	8	350	-	-	-	-	
						.HI								.30	570							
														.27	711							
														.30	927							
		.40	767																			

ESPIGA	REF.	DIMENSIONS	FINISHES	LAMP	DIFFUSER	POWER	CRI	K	LUMEN	WATT	mA	DIMM	SKETCH	
	10086	.02	.WH-WH	LED	.OP	.ST	.9	.27	1538	16	500	-	-	
								.30	1722					
								.40	1355					

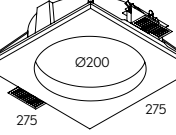
ESPIGA	REF.	DIMENSIONS	FINISHES	LAMP	DIFFUSER	POWER	CRI	K	LUMEN	WATT	mA	DIMM	SKETCH	
	10086	.03*	.WH-WH	LED	.OP	.ST	.9	-	-	25	600	-	-	
								.30	1700					
								.40	2040					

FINISHES



DIMENSIONS

.01 | .02 | .03

LIGHTING OPTIONS

DIFFUSER

OPAL

POWER

STANDARD | HIGH

CRI

90

COLOR TEMPERATURE

2700K | 3000K | 4000K

DIMMABLE OPTIONS

DALI | 1.10 | PUSH

LIGHT DISTRIBUTION

DOWN



CRISMOSIL

TRIMLESS

LUMINAIRE INCLUDES

Recessed with frame mounting kit

Reference order

10086.XX.TR.WH-WH.XX.XXX.XXX.XX

10-20 mm Espesor del falso techo Ceiling thickness

*.03 is Class I - .03 es Clase I.

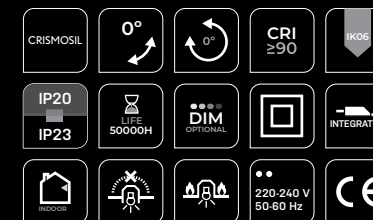

ESPIGA

REF 10086.TR

PHOTOMETRY

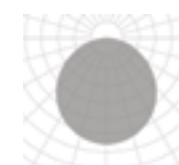

OPAL

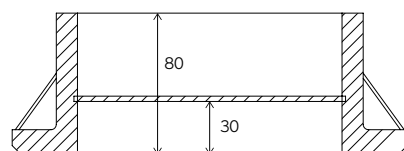

ESPIGA SQ	REF.	DIMENSIONS	FINISHES	LAMP	DIFFUSER	POWER	CRI	K	LUMEN	WATT	mA	DIMM	SKETCH			
	10083	.01	.WH-WH	GU5.3		GU5.3	.9	-	526	Max 8	-	-				
				GU10	.GU	GU10										
				LED	.OP	.ST								BPM50		
						.HI									BPM300	
						.27										526
						.30										570
				.27	707											
				.30	927											
				.40	767											

ESPIGA SQ	REF.	DIMENSIONS	FINISHES	LAMP	DIFFUSER	POWER	CRI	K	LUMEN	WATT	mA	DIMM	SKETCH
	10083	.02	.WH-WH	LED	.OP	.ST	.9	.27	1538	16	500	.DA .PU .D1	
								.30	1722				
								.40	1355				

ESPIGA SQ	REF.	DIMENSIONS	FINISHES	LAMP	DIFFUSER	POWER	CRI	K	LUMEN	WATT	mA	DIMM	SKETCH
	10083	.03*	.WH-WH	LED	.OP	.ST	.9	-	-	25	600	.DA .PU .D1	
								.30	1700				
								.40	2040				

10-20 mm ↑ Espesor del falso techo
Ceiling thickness

LUMINAIRE INCLUDES

Recessed with frame mounting kit

Reference order

10083.XX.TR.WH-WH.XX.XX.XX.XX

*.03 is Class I - .03 es Clase I.

FINISHES

□

DIMENSIONS

.01 | .02 | .03

LIGHTING OPTIONS

DIFFUSER

OPAL

POWER

STANDARD | HIGH

CRI

90

COLOR TEMPERATURE

2700K | 3000K | 4000K

DIMMABLE OPTIONS

DALI | 1.10 | PUSH

LIGHT DISTRIBUTION

DOWN

CRISMOSIL

.TR

TRIMLESS

ESPIGA SQ

REF 10083.TR

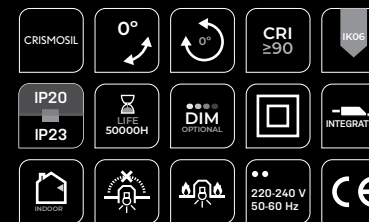

PHOTOMETRY

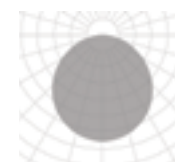

OPAL

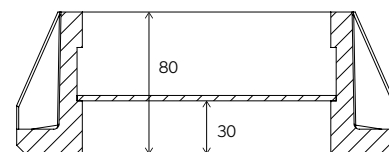

ESPIGA SIRIO	REF.	DIMENSIONS	FINISHES	LAMP	DIFFUSER	POWER	CRI	K	LUMEN	WATT	mA	DIMM	SKETCH	
	10077	.01	.WH-WH	GU5.3	.GU	GU5.3	.9	-	526	Max 8	-	-		
				GU10		GU10								
				LED	.OP	.ST								.DA .PU .D1
						BPM50								
						.HI								
						BPM300								

ESPIGA SIRIO	REF.	DIMENSIONS	FINISHES	LAMP	DIFFUSER	POWER	CRI	K	LUMEN	WATT	mA	DIMM	SKETCH
	10077	.02	.WH-WH	LED	.OP	.ST	.9	.27	1538	16	500	.DA .PU .D1	
								.30	1722				
								.40	1355				

ESPIGA SIRIO	REF.	DIMENSIONS	FINISHES	LAMP	DIFFUSER	POWER	CRI	K	LUMEN	WATT	mA	DIMM	SKETCH
	10077	.03*	.WH-WH	LED	.OP	.ST	.9	-	-	25	600	.DA .PU .D1	
								.30	1700				
								.40	2040				

10-20 mm ↑ Espesor del falso techo
Ceiling thickness

LUMINAIRE INCLUDES

Recessed with frame mounting kit

Reference order

10077.XX.TR.WH-WH.XX.XX.XXX.XX

*.03 is Class I - .03 es Clase I.

FINISHES

□

DIMENSIONS

.01 | .02 | .03

LIGHTING OPTIONS

DIFFUSER

OPAL

POWER

STANDARD | HIGH

CRI

90

COLOR TEMPERATURE

2700K | 3000K | 4000K

DIMMABLE OPTIONS

DALI | 1.10 | PUSH

LIGHT DISTRIBUTION

DOWN



CRISMOSIL

TRIMLESS

ESPIGA SIRIO

REF 10077.TR



PHOTOMETRY

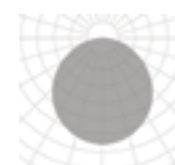

OPAL

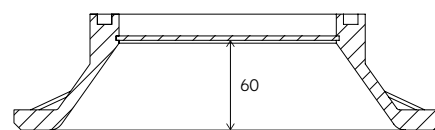

ESPIGA SIRIO TWINS	REF.	DIMENSIONS	FINISHES	LAMP	DIFFUSER	POWER	CRI	K	LUMEN	WATT	mA	DIMM	SKETCH
	30000	.WH-.WH	●	LED	.OP	.ST	.9	.27	3280	23	500	.DA .PU .D1	
								.30	3480				
								.40	3640				
								.27	6560	47	500		
								.30	6920				
								.40	7269				

10 - 20 mm | Espesor del falso techo
Ceiling thickness

LUMINAIRE INCLUDES

Recessed with frame mounting kit

Reference order

30000.01.TR.WH-WH.XX.XX.X.XX.XX

FINISHES



DIMENSIONS

.01

LIGHTING OPTIONS

DIFFUSER

OPAL

POWER

STANDARD | HIGH

CRI

90

COLOR TEMPERATURE

2700K | 3000K | 4000K

DIMMABLE OPTIONS

DALI | 1.10 | PUSH

LIGHT DISTRIBUTION

DOWN



ESPIGA SIRIO TWINS

REF 30000.TR



PHOTOMETRY

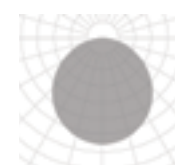

OPAL

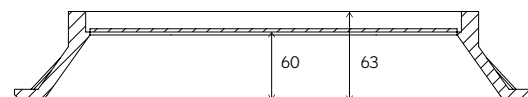

ESPIGA ORIONIS	REF.	DIMENSIONS	FINISHES	LAMP	DIFFUSER	POWER	CRI	K	LUMEN	WATT	mA	DIMM	SKETCH		
	10080	.01	.WH-WH	GU5.3	.GU	GU5.3	.9	-	526	Max 8	-	.DA .PU .D1			
				GU10		GU10									
				LED	.OP	.ST								.27	570
						.HI								.40	711
														.27	707
														.30	927
			.40	767											

ESPIGA ORIONIS	REF.	DIMENSIONS	FINISHES	LAMP	DIFFUSER	POWER	CRI	K	LUMEN	WATT	mA	DIMM	SKETCH
	10080	.02	.WH-WH	LED	.OP	.ST	.9	.27	1538	16	500	.DA .PU .D1	
								.30	1722				
								.40	1355				

ESPIGA ORIONIS	REF.	DIMENSIONS	FINISHES	LAMP	DIFFUSER	POWER	CRI	K	LUMEN	WATT	mA	DIMM	SKETCH
	10080	.03*	.WH-WH	LED	.OP	.ST	.9	.27	1647	25	600	.DA .PU .D1	
								.30	1700				
								.40	2040				

10 - 20 mm ↑ Espesor del falso techo
Ceiling thickness

LUMINAIRE INCLUDES

Recessed with frame mounting kit

Reference order

10080.XX.TR.WH-WH.XX.XX.X.XX.XX

*.03 is Class I - .03 es Clase I.

FINISHES

□

DIMENSIONS

.01 | .02 | .03

LIGHTING OPTIONS

DIFFUSER

OPAL

POWER

STANDARD | HIGH

CRI

90

COLOR TEMPERATURE

2700K | 3000K | 4000K

DIMMABLE OPTIONS

DALI | 1.10 | PUSH

LIGHT DISTRIBUTION

DOWN



CRISMOSIL

.TR

TRIMLESS

ESPIGA ORIONIS

REF 10080.TR

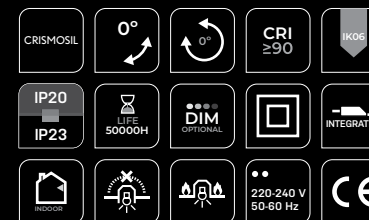

PHOTOMETRY

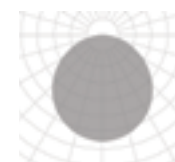

OPAL

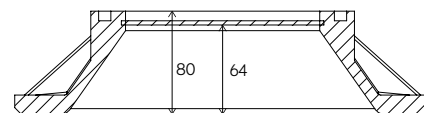

ESPIGA ORIONIS TWINS	REF.	DIMENSIONS	FINISHES	LAMP	DIFFUSER	POWER	CRI	K	LUMEN	WATT	mA	DIMM	SKETCH
	30001	.01	.WH-WH	LED	.OP	.ST	.9	.27	-	20	500	.DA .PU .D1	
						.30		3040					
						.40		3180					
						.27		-	41	500			
						.30		6060					
						.40		6360					

10 - 20 mm | Espesor del falso techo
Ceiling thickness

LUMINAIRE INCLUDES

Recessed with frame mounting kit

Reference order | 30001.01.TR.WH-WH.XX.XX.X.XX.XX

FINISHES



DIMENSIONS

.01

LIGHTING OPTIONS

DIFFUSER

OPAL

POWER

STANDARD | HIGH

CRI

90

COLOR TEMPERATURE

2700K | 3000K | 4000K

DIMMABLE OPTIONS

DALI | 1.10 | PUSH

LIGHT DISTRIBUTION

DOWN



CRISMOSIL

.TR
TRIMLESS

- CRISMOSIL
- 0°
- 0°
- CRI ≥ 90
- IP20
- IP23
- LIFE 50000H
- DIM OPTIONAL
- INTEGRATED
- RECESSED
- 220-240 V 50-60 Hz
- CE

ESPIGA ORIONIS TWINS

REF 30001.TR

PHOTOMETRY

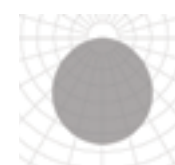

OPAL

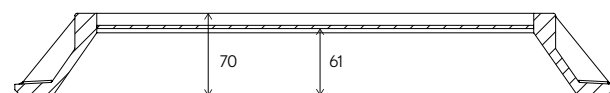

FINISHES



DIMENSIONS

.01

LIGHTING OPTIONS

BEAM ANGLE / LAMP

40° | 60° | GU5.3 | GU10

POWER

STANDARD | HIGH

CRI

90

COLOR TEMPERATURE

2700K | 3000K | 4000K

DIMMABLE OPTIONS

DALI | 1.10 | PUSH

LIGHT DISTRIBUTION

DOWN

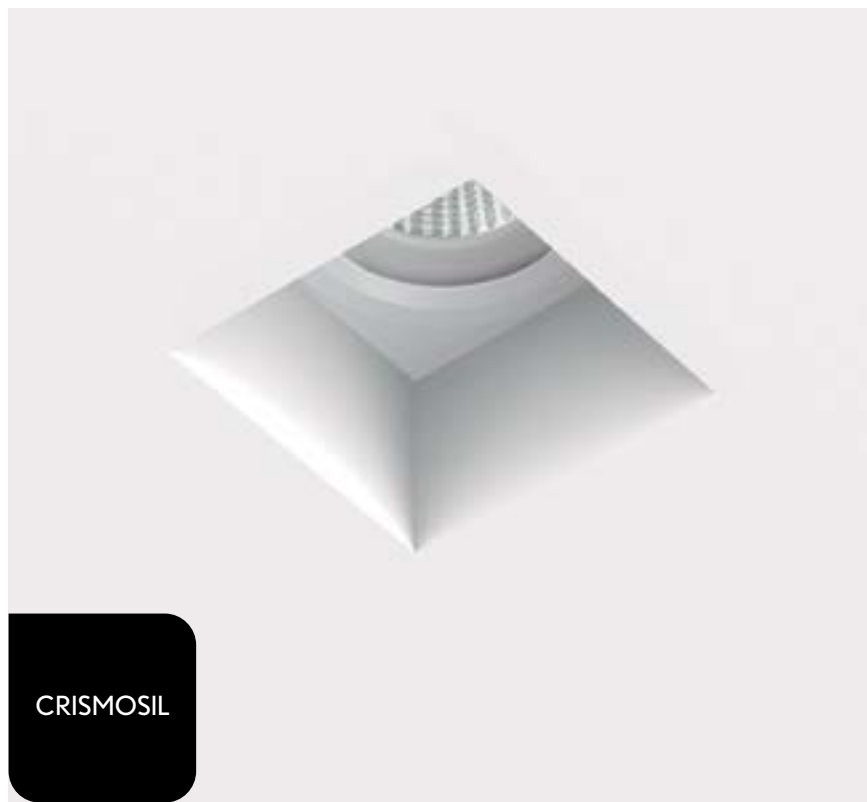

CRISMOSIL

ZENIT SQ	REF.	DIMEN-SIONS	FINISHES	LAMP	OPTIC OPTIONS	POWER	CRI	K	LUMEN	WATT	mA	DIMM	SKETCH				
	30002	.01	.WH-WH	GU5.3		GU5.3	.9	.27	526	Max 8	350	.DA .PU .D1					
				GU10	.GU	GU10			570								
				LED	.40 .60	.ST BPMSO			.9					.27	711		
															.30	707	
																.30	927
																	.40

7 - 22 mm ↑ Espesor del falso techo Ceiling thickness

LUMINAIRE INCLUDES

Reference order

30002.01.TR.WH-WH.XX.XX.XXX.XX

Recessed with frame mounting kit

FINISHES



DIMENSIONS

.01

LIGHTING OPTIONS

BEAM ANGLE / LAMP

40° | 60° | GU5.3 | GU10

POWER

STANDARD | HIGH

CRI

90

COLOR TEMPERATURE

2700K | 3000K | 4000K

DIMMABLE OPTIONS

DALI | 1.10 | PUSH

LIGHT DISTRIBUTION

DOWN



CRISMOSIL

ZENIT	REF.	DIMEN-SIONS	FINISHES	LAMP	BEAM ANGLE	POWER	CRI	K	LUMEN	WATT	mA	DIMM	SKETCH				
	10123	.01	.WH-WH	GU5.3		GU5.3	.9	.27	526	Max 8	350	.DA .PU .D1					
				GU10	.GU	GU10			570								
				LED	.40 .60	.ST BPMSO			.9					.27	711		
															.30	707	
																.30	927
																	.40

7 - 22 mm ↑ Espesor del falso techo Ceiling thickness

LUMINAIRE INCLUDES

Reference order

10123.01.TR.WH-WH.XX.XX.XXX.XX

Recessed with frame mounting kit

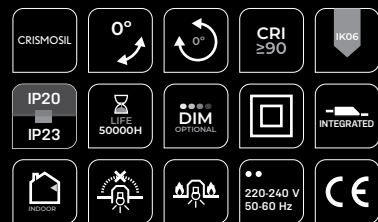

ZENIT

SQ

REF 30002.TR

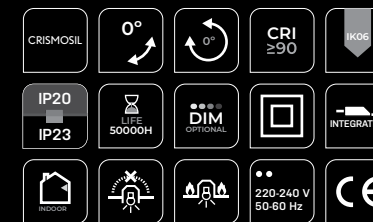

ZENIT

REF 10123.TR

PHOTOMETRY

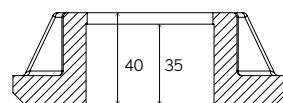
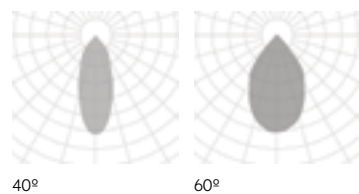

PHOTOMETRY

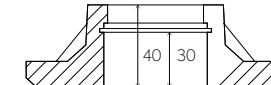
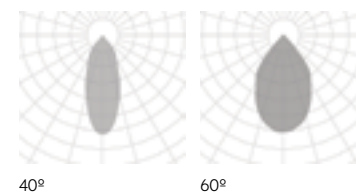

• FINISHES



• DIMENSIONS

.01

LIGHTING OPTIONS

■ BEAM ANGLE / LAMP

40° | 60° | GU5.3 | GU10

POWER

STANDARD | HIGH

CRI

90

COLOR TEMPERATURE

2700K | 3000K | 4000K

▼ DIMMABLE OPTIONS

DALI | 1.10 | PUSH

▲ LIGHT DISTRIBUTION

DOWN



• FINISHES



• DIMENSIONS

.01

LIGHTING OPTIONS

■ BEAM ANGLE / LAMP

40° | 60° | GU5.3 | GU10

POWER

STANDARD | HIGH

CRI

90

COLOR TEMPERATURE

2700K | 3000K | 4000K

▼ DIMMABLE OPTIONS

DALI | 1.10 | PUSH

▲ LIGHT DISTRIBUTION

DOWN



ZENIT DEEP	REF.	DIMEN-SIONS	FINISHES	LAMP	OPTIC OPTIONS	POWER	CRI	K	LUMEN	WATT	mA	DIMM	SKETCH					
	30004	.01	.WH-WH	GU5.3		GU5.3	9	.27 .30 .40 .27 .30 .40	526 570 711 707 927 767	Max 8	350	.DA .PU .D1						
				GU10	.GU	GU10												
				LED	.40 .60	.ST BPM50								.HI BPM300				
															16	350		
																	20	500

ZENIT DEEP TWINS	REF.	DIMEN-SIONS	FINISHES	LAMP	OPTIC OPTIONS	POWER	CRI	K	LUMEN	WATT	mA	DIMM	SKETCH					
	30005	.01	.WH-WH	GU5.3		GU5.3	9	.27 .30 .40 .27 .30 .40	1052 1140 1422 1414 1854 1534	Max 2x8	350	.DA .PU .D1						
				GU10	.GU	GU10												
				LED	.40 .60	.ST BPM50								.HI BPM300				
															16	350		
																	20	500

7 - 22 mm ↑ Espesor del falso techo Ceiling thickness

LUMINAIRE INCLUDES

Reference order

30004.01.TR.WH-WH.XX.XX.X.XX.XX

Recessed with frame mounting kit

7 - 22 mm ↑ * Espesor del falso techo Ceiling thickness

LUMINAIRE INCLUDES

Reference order

30005.01.TR.WH-WH.XX.XX.X.XX.XX

Recessed with frame mounting kit



ZENIT DEEP

REF 30004.TR



ZENIT DEEP TWINS

REF 30005.TR

PHOTOMETRY

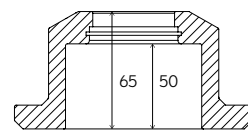
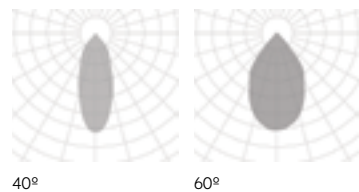

PHOTOMETRY

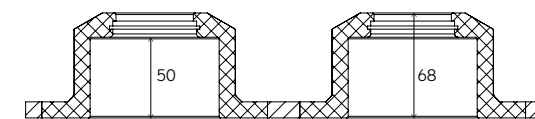
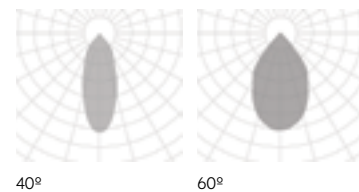

• FINISHES



• DIMENSIONS

.01

LIGHTING OPTIONS

■ BEAM ANGLE / LAMP

40° | 60° | GU5.3 | GU10

POWER

STANDARD

CRI

90

COLOR TEMPERATURE

2700K | 3000K | 4000K

▼ DIMMABLE OPTIONS

DALI | 1.10 | PUSH

▲ LIGHT DISTRIBUTION

DOWN



CRISMOSIL

• FINISHES



• DIMENSIONS

.01

LIGHTING OPTIONS

■ BEAM ANGLE / LAMP

40° | 60° | GU5.3 | GU10

POWER

STANDARD

CRI

90

COLOR TEMPERATURE

2700K | 3000K | 4000K

▼ DIMMABLE OPTIONS

DALI | 1.10 | PUSH

▲ LIGHT DISTRIBUTION

DOWN



CRISMOSIL

ZENIT MOVE	REF.	DIMEN-SIONS	FINISHES	LAMP	OPTIC OPTIONS	POWER	CRI	K	LUMEN	WATT	mA	DIMM	SKETCH
	10125	.01	.WH-WH	GU5.3		GU5.3	.9	.27	526	Max 8	-	.DA .PU .D1	
				GU10	.GU	GU10							
				LED	.40 .60	.ST BPMSO							

ZENIT MOVE SQ	REF.	DIMEN-SIONS	FINISHES	LAMP	OPTIC OPTIONS	POWER	CRI	K	LUMEN	WATT	mA	DIMM	SKETCH
	30003	.01	.WH-WH	GU5.3		GU5.3	.9	.27	526	Max 8	-	.DA .PU .D1	
				GU10	.GU	GU10							
				LED	.40 .60	.ST BPMSO							

7 - 22 mm ↑ Espesor del falso techo Ceiling thickness

LUMINAIRE INCLUDES

Reference order

10125.01.TR.WH-WH.XX.XX.X.XX.XX

Recessed with frame mounting kit

7 - 22 mm ↑ Espesor del falso techo Ceiling thickness

LUMINAIRE INCLUDES

Reference order

30003.01.TR.WH-WH.XX.XX.X.XX.XX

Recessed with frame mounting kit



ZENIT MOVE

REF 10125.TR



ZENIT MOVE SQ

REF 30003.TR

PHOTOMETRY

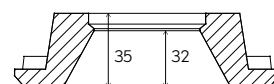
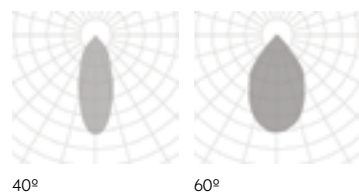

PHOTOMETRY

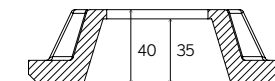
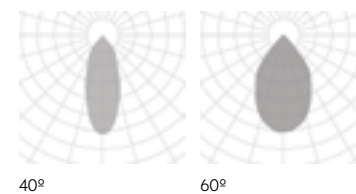

• FINISHES



• DIMENSIONS

.01

LIGHTING OPTIONS

■ BEAM ANGLE / LAMP

40° | 60° | GU5.3 | GU10

POWER

STANDARD | HIGH

CRI

90

COLOR TEMPERATURE

2700K | 3000K | 4000K

▼ DIMMABLE OPTIONS

DALI | 1.10 | PUSH

▲ LIGHT DISTRIBUTION

DOWN



• FINISHES



• DIMENSIONS

.01

LIGHTING OPTIONS

■ BEAM ANGLE / LAMP

40° | 60° | GU5.3 | GU10

POWER

STANDARD | HIGH

CRI

90

COLOR TEMPERATURE

2700K | 3000K | 4000K

▼ DIMMABLE OPTIONS

DALI | 1.10 | PUSH

▲ LIGHT DISTRIBUTION

DOWN



ZENIT ORTO	REF.	DIMEN-SIONS	FINISHES	LAMP	OPTIC OPTIONS	POWER	CRI	K	LUMEN	WATT	mA	DIMM	SKETCH							
	10126	.01	.WH-.WH	GU5.3		GU5.3	9	.27 .30 .40 .27 .30 .40	526 570 711 707 927 767	Max 8	-	.DA .PU .D1								
				GU10	.GU	GU10														
				LED	.40 .60	.ST BPM50								8	350					
																.HI BPM300	10	500		
																			-	-

ZENIT SIDEREA	REF.	DIMEN-SIONS	FINISHES	LAMP	OPTIC OPTIONS	POWER	CRI	K	LUMEN	WATT	mA	DIMM	SKETCH							
	10050	.01	.WH-.WH	GU5.3		GU5.3	9	.27 .30 .40 .27 .30 .40	526 570 711 707 927 767	Max 8	-	.DA .PU .D1								
				GU10	.GU	GU10														
				LED	.40 .60	.ST BPM50								8	350					
																.HI BPM300	10	500		
																			-	-

7 - 22 mm ↑ Espesor del falso techo Ceiling thickness

LUMINAIRE INCLUDES

Reference order

10126.01.TR.WH-WH.XX.XX.X.XX.XX

Recessed with frame mounting kit

7 - 22 mm ↑ Espesor del falso techo Ceiling thickness

LUMINAIRE INCLUDES

Reference order

10050.01.TR.WH-WH.XX.XX.X.XX.XX

Recessed with frame mounting kit



ZENIT ORTO

REF 10126.TR



ZENIT SIDEREA

REF 10050.TR

PHOTOMETRY

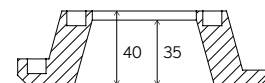
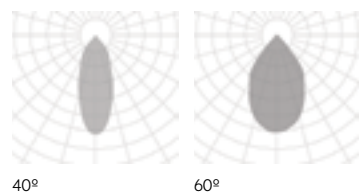

PHOTOMETRY

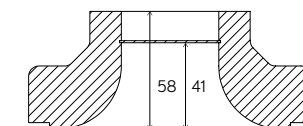
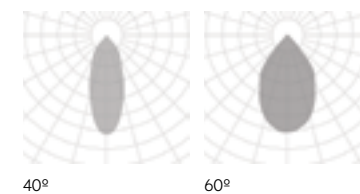

• FINISHES



• DIMENSIONS

.01

LIGHTING OPTIONS

■ BEAM ANGLE / LAMP

40° | 60° | GU5.3 | GU10

POWER

STANDARD | HIGH

CRI

90

COLOR TEMPERATURE

2700K | 3000K | 4000K

▼ DIMMABLE OPTIONS

DALI | 1.10 | PUSH

▲ LIGHT DISTRIBUTION

DOWN



CRISMOSIL

Puede fijarse en cualquier posición desde empotrado hasta 35mm de saliente.
It can be mounted in any position from recessed up to 35mm protruding.

• FINISHES



• DIMENSIONS

.01

LIGHTING OPTIONS

■ BEAM ANGLE / LAMP

40° | 60° | GU5.3 | GU10

POWER

STANDARD | HIGH

CRI

90

COLOR TEMPERATURE

2700K | 3000K | 4000K

▼ DIMMABLE OPTIONS

DALI | 1.10 | PUSH

▲ LIGHT DISTRIBUTION

DOWN



CRISMOSIL

Puede fijarse en cualquier posición desde empotrado hasta 35mm de saliente.
It can be mounted in any position from recessed up to 35mm protruding.

ZENIT ZUBIA	REF.	DIMEN- SIONS	FINISHES	LAMP	OPTIC OPTIONS	POWER	CRI	K	LUMEN	WATT	mA	DIMM	SKETCH					
	10122	.01	.WH-.WH .WH-.BK	GU5.3		GU5.3	90	-	526	Max 8	-	.DA .PU .D1						
				GU10	.GU	GU10												
				LED	.40 .60	.ST BPMSO								.9	.27	526	8	350
															.30	570		
															.40	711		
															.27	707		
				.30	927	.HI BPMSO								.40	767	10	500	

ZENIT ZUBIASQ	REF.	DIMEN- SIONS	FINISHES	LAMP	OPTIC OPTIONS	POWER	CRI	K	LUMEN	WATT	mA	DIMM	SKETCH					
	10121	.01	.WH-.WH .WH-.BK	GU5.3		GU5.3	90	-	526	Max 8	-	.DA .PU .D1						
				GU10	.GU	GU10												
				LED	.40 .60	.ST BPMSO								.9	.27	526	8	350
															.30	570		
															.40	711		
															.27	707		
				.30	927	.HI BPMSO								.40	767	10	500	

7 - 22 mm | Espesor del falso techo
Ceiling thickness

LUMINAIRE INCLUDES

Reference order | 10122.01.TR.XX.XX.XX.X.XX.XX

Recessed with frame mounting kit

7 - 22 mm | Espesor del falso techo
Ceiling thickness

LUMINAIRE INCLUDES

Reference order | 10121.01.TR.XX.XX.XX.X.XX.XX

Recessed with frame mounting kit

CRISMOSIL | 0° | 0° | CRI ≥90 | IK05
IP20 | LIFE 50000H | DIM OPTIONAL | INTEGRATED
RECESSED | 220-240 V 50-60 Hz | CE

ZENIT ZUBIA

REF 10122.TR

CRISMOSIL | 0° | 0° | CRI ≥90 | IK05
IP20 | LIFE 50000H | DIM OPTIONAL | INTEGRATED
RECESSED | 220-240 V 50-60 Hz | CE

ZENIT ZUBIA SQ

REF 10121.TR

PHOTOMETRY

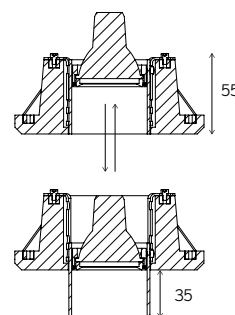
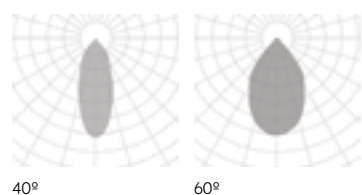

PHOTOMETRY

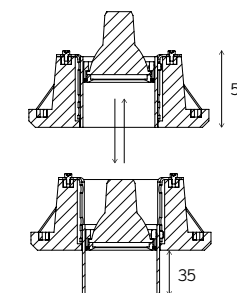
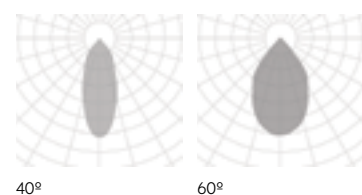

SUNSET	REF.	DIMEN-SIONS	FINISHES	LAMP	OPTIC OPTIONS	POWER	CRI	K	LUMEN	WATT	mA	DIMM	SKETCH
	10124	.01	.WH-WH	GU5.3		GU5.3	.9	.27	526	Max 8	350	.DA .PU .D1	
				GU10	.GU	GU10							
				LED	.40 .60	.ST BPM50							
						.40		.711					

SUNSET	REF.	DIMEN-SIONS	FINISHES	LAMP	OPTIC OPTIONS	POWER	CRI	K	LUMEN	WATT	mA	DIMM	SKETCH
	10124	.02	.WH-WH	GU5.3		GU5.3	.9	.27	526	Max 8	350	.DA .PU .D1	
				GU10	.GU	GU10							
				LED	.40 .60	.ST BPM50							
						.40		.711					

SUNSET	REF.	DIMEN-SIONS	FINISHES	LAMP	OPTIC OPTIONS	POWER	CRI	K	LUMEN	WATT	mA	DIMM	SKETCH				
 	10124	.03	.WH-WH	GU5.3		GU5.3	.9	.27	1538	Max 20	500	.DA .PU .D1					
				GU10	.GU	GU10											
				GX8.5	.CD	GX8.5								.30	1722	16	16
				LED	.40 .60	.ST BPM3181								.40	1355	16	16

7 - 22 mm **.01** Espesor del falso techo
Ceiling thickness

10 - 20 mm **.02 .03** Espesor del falso techo
Ceiling thickness

Con difusor opal.
With opal optic cover.

LUMINAIRE INCLUDES

Recessed with frame mounting kit

Reference order

10124.XX.TR.WH-WH.XX.XX.X.XX.XX

FINISHES

□

DIMENSIONS

.01 | .02 | .03

LIGHTING OPTIONS

BEAM ANGLE / LAMP

40° | 60° | GU5.3 | GU10 | GX8.5

POWER

STANDARD

CRI

90

COLOR TEMPERATURE

2700K | 3000K | 4000K

DIMMABLE OPTIONS

DALI | 1.10 | PUSH

LIGHT DISTRIBUTION

DOWN



CRISMOSIL

TRIMLESS

SUNSET

REF 10124.TR

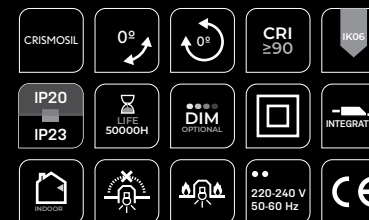

PHOTOMETRY

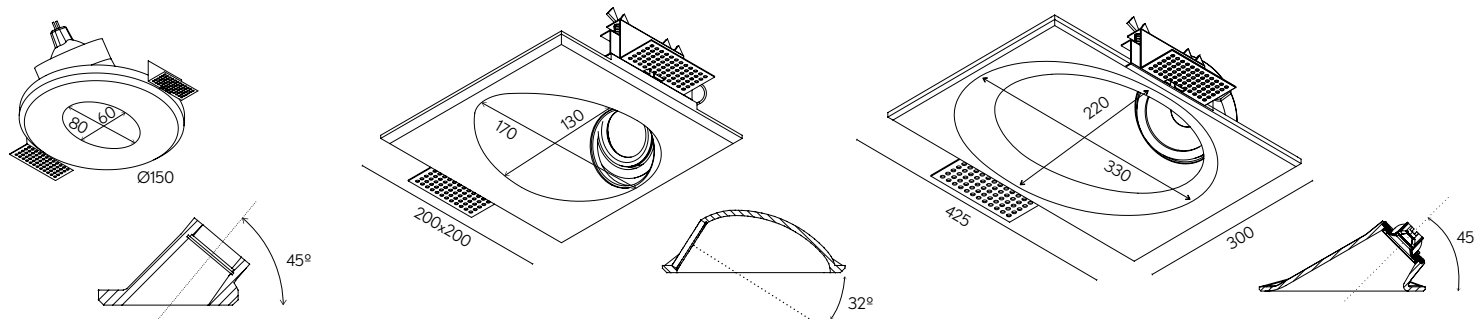
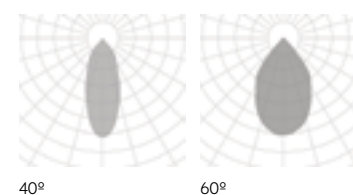

VEGA ADHARA	REF.	DIMENSIONS	FINISHES	LAMP	OPTIC OPTIONS	POWER	CRI	K	LUMEN	WATT	mA	DIMM	SKETCH	
	10016	.01	.WH-WH	GU5.3		GU5.3	.9	.27 .30 .40 .27 .30 .40	526	Max 8	350	.DA .PU .D1		
				GU10	.GU	GU10			570					
				LED	.40 .60	.ST BPM50			711	10				500
									707					
									927					
									767					

VEGA ADAHARA	REF.	DIMENSIONS	FINISHES	LAMP	OPTIC OPTIONS	POWER	CRI	K	LUMEN	WATT	mA	DIMM	SKETCH	
	10016	.02	.WH-WH	GU5.3		GU5.3	.9	.27 .30 .40	1538	Max 20	500	.DA .PU .D1		
				GU10	.GU	GU10			1722					
				GX8.5	.CD	GX8.5			1355					
				LED	.40 .60	.ST BPM3181			1538	16				500
									1722					
									1355					

10 - 20 mm **.01** Espesor del falso techo
Ceiling thickness

13 mm **.02** Espesor del falso techo
Ceiling thickness

LUMINAIRE INCLUDES

Reference order

10016.XX.TR.WH-WH.XX.XX.X.XX.XX

Recessed with frame mounting kit

FINISHES



DIMENSIONS

.01 | .02

LIGHTING OPTIONS

BEAM ANGLE / LAMP

40° | 60° | GU5.3 | GU10 | GX8.5

POWER

STANDARD | HIGH

CRI

90

COLOR TEMPERATURE

2700K | 3000K | 4000K

DIMMABLE OPTIONS

DALI | 1.10 | PUSH

LIGHT DISTRIBUTION

DOWN

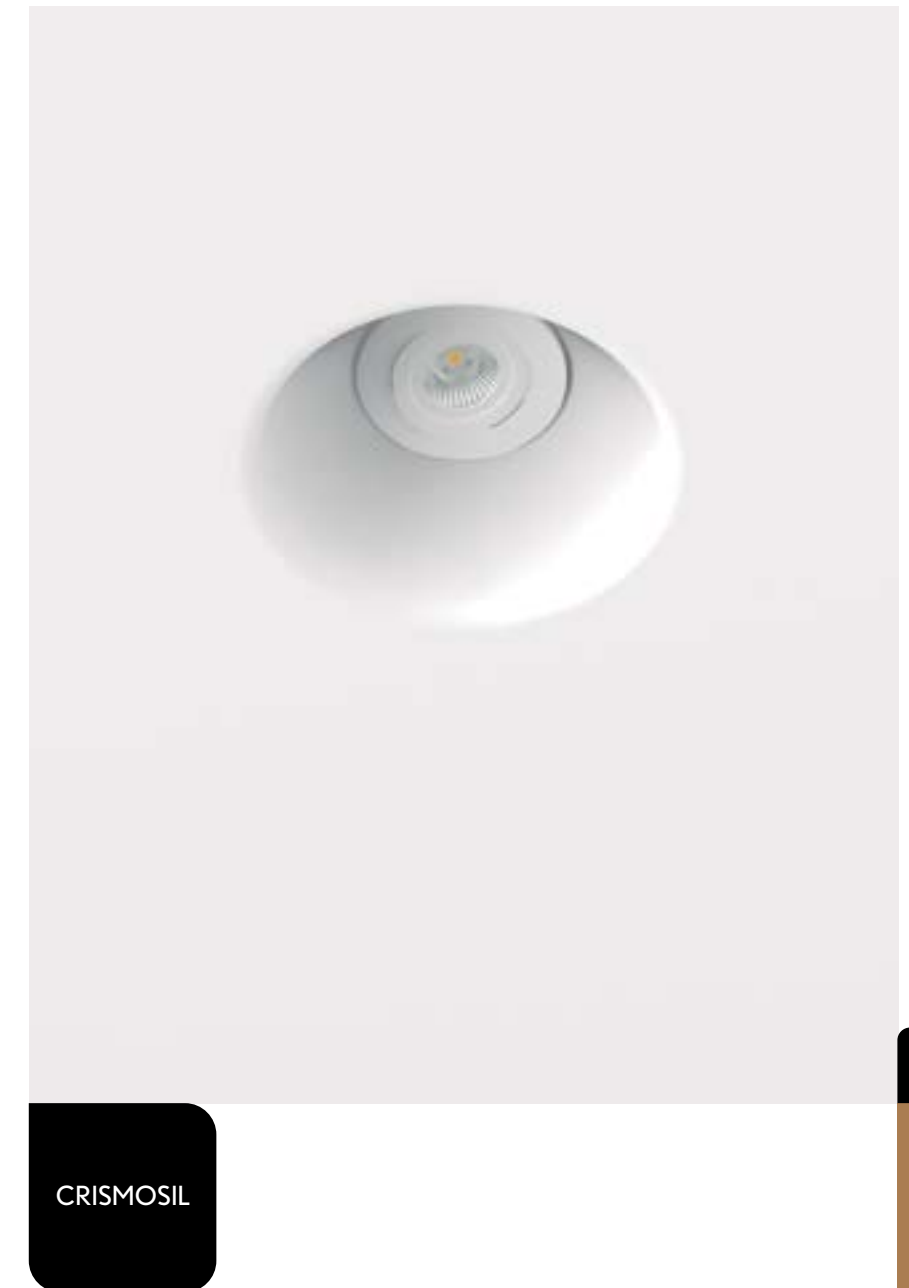

CRISMOSIL

.TR

TRIMLESS

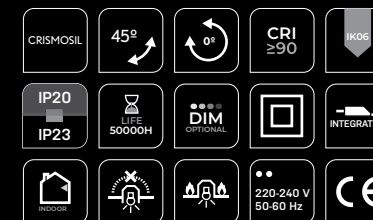

VEGA ADHARA

REF 10016.TR

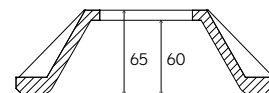

PHOTOMETRY

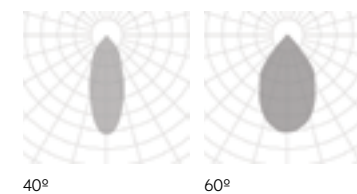

40°

60°

VEGA ADHARA TWINS	REF.	DIMENSIONS	FINISHES	LAMP	OPTIC OPTIONS	POWER	CRI	K	LUMEN	WATT	mA	DIMM	SKETCH	
	10066	.01	.WH-WH	GU5.3		GU5.3	.9	.27	1052	Max 2x8	350	.DA .PU .D1		
				GU10	.GU	GU10			.30					1140
				LED	.40 .60	.ST BPM50			.27					1422
									.30					1414
									.40					1534

VEGA ADHARA TWINS	REF.	DIMENSIONS	FINISHES	LAMP	OPTIC OPTIONS	POWER	CRI	K	LUMEN	WATT	mA	DIMM	SKETCH	
	10066	.02	.WH-WH	GU5.3		GU5.3	.9	.27	3076	Max 2x20	500	.DA .PU .D1		
				GU10	.GU	GU10			.30					3444
				GX8.5	.CD	GX8.5			.40					2710
				LED	.40 .60	.ST BPM3181			.30					3444
									.40					2710

10 - 20 mm * Espesor del falso techo
Ceiling thickness

13 mm * Espesor del falso techo
Ceiling thickness

LUMINAIRE INCLUDES

Reference order

10066.XX.TR.WH-WH.XX.XX.XXX.XX

Recessed with frame mounting kit

FINISHES

□

DIMENSIONS

.01 | .02

LIGHTING OPTIONS

BEAM ANGLE / LAMP

40° | 60° | GU5.3 | GU10 | GX8.5

POWER

STANDARD | HIGH

CRI

90

COLOR TEMPERATURE

2700K | 3000K | 4000K

DIMMABLE OPTIONS

DALI | 1.10 | PUSH

LIGHT DISTRIBUTION

DOWN

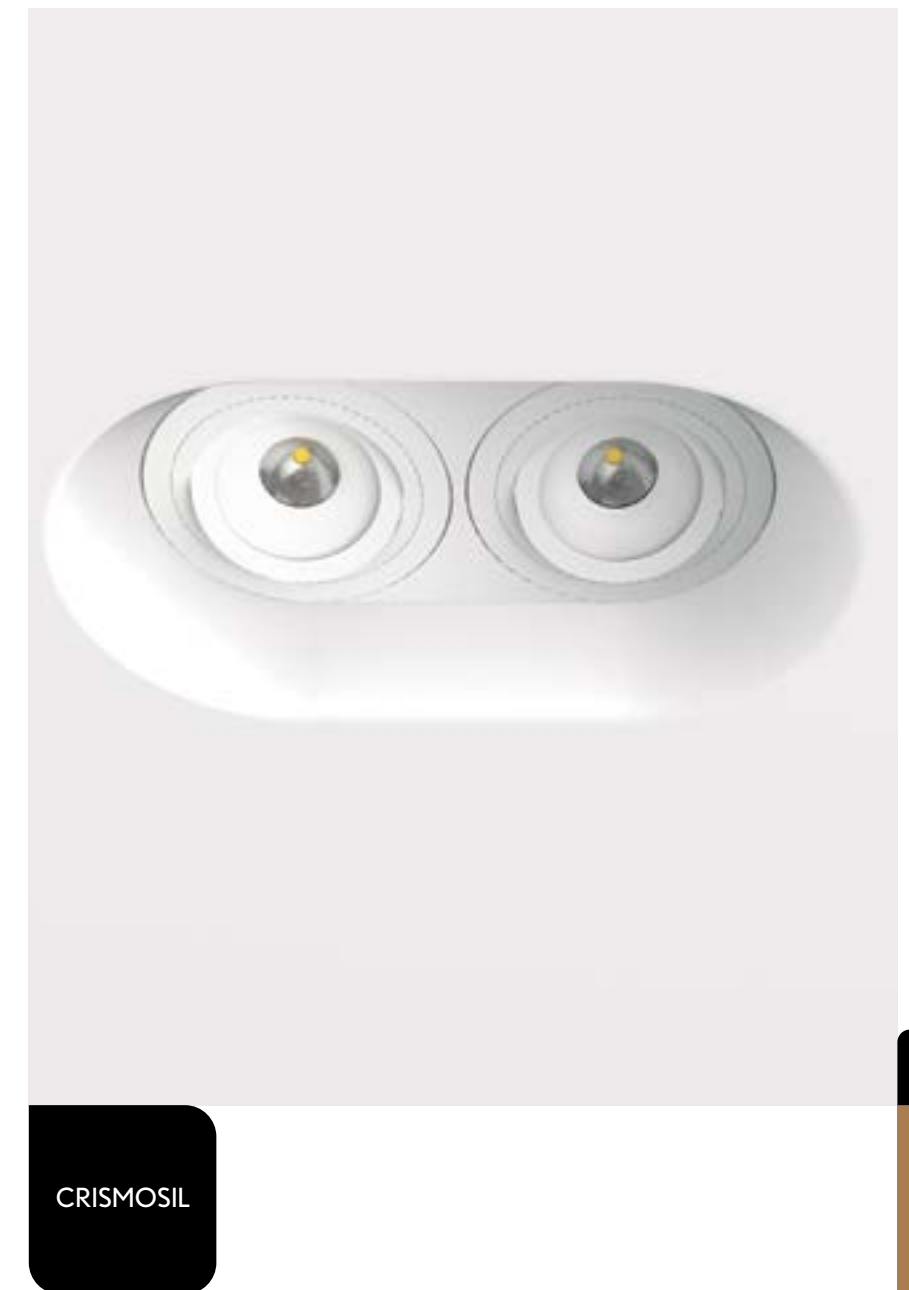

CRISMOSIL

.TR

TRIMLESS

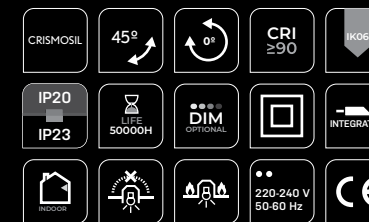

VEGA ADHARA TWINS



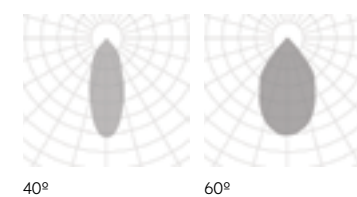

REF 10066.TR





PHOTOMETRY

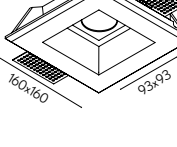

40°

60°

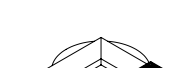
VEGA	REF.	DIMENSIONS	FINISHES	LAMP	OPTIC OPTIONS	POWER	CRI	K	LUMEN	WATT	mA	DIMM	SKETCH				
 	10028	.01	.WH-WH	GU5.3		GU5.3	.9	-	526	Max 8	-	.DA .PU .D1	  				
				GU10	.GU	GU10											
				LED	.40 .60	.ST BPM50				.30				570	8	350	
														.27			711
														.27			707
														.30			927
			.HI BPM200	.40	.30	767	10	500									

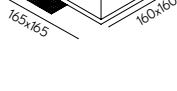
VEGA	REF.	DIMENSIONS	FINISHES	LAMP	OPTIC OPTIONS	POWER	CRI	K	LUMEN	WATT	mA	DIMM	SKETCH				
	10028	.02	.WH-WH	GU5.3		GU5.3	.9	-	1538	Max 20	-	.DA .PU .D1	   				
				GU10	.GU	GU10											
				GX8.5	.CD	GX8.5											
				LED	.40 .60	.ST BPM3181				.30				1722	16	500	
														.27			1355
														.40			

FINISHES



DIMENSIONS

.01 | .02

LIGHTING OPTIONS

BEAM ANGLE / LAMP

40° | 60° | GU5.3 | GU10 | GX8.5

POWER

STANDARD | HIGH

CRI

90

COLOR TEMPERATURE

2700K | 3000K | 4000K

DIMMABLE OPTIONS

DALI | 1.10 | PUSH

LIGHT DISTRIBUTION

DOWN

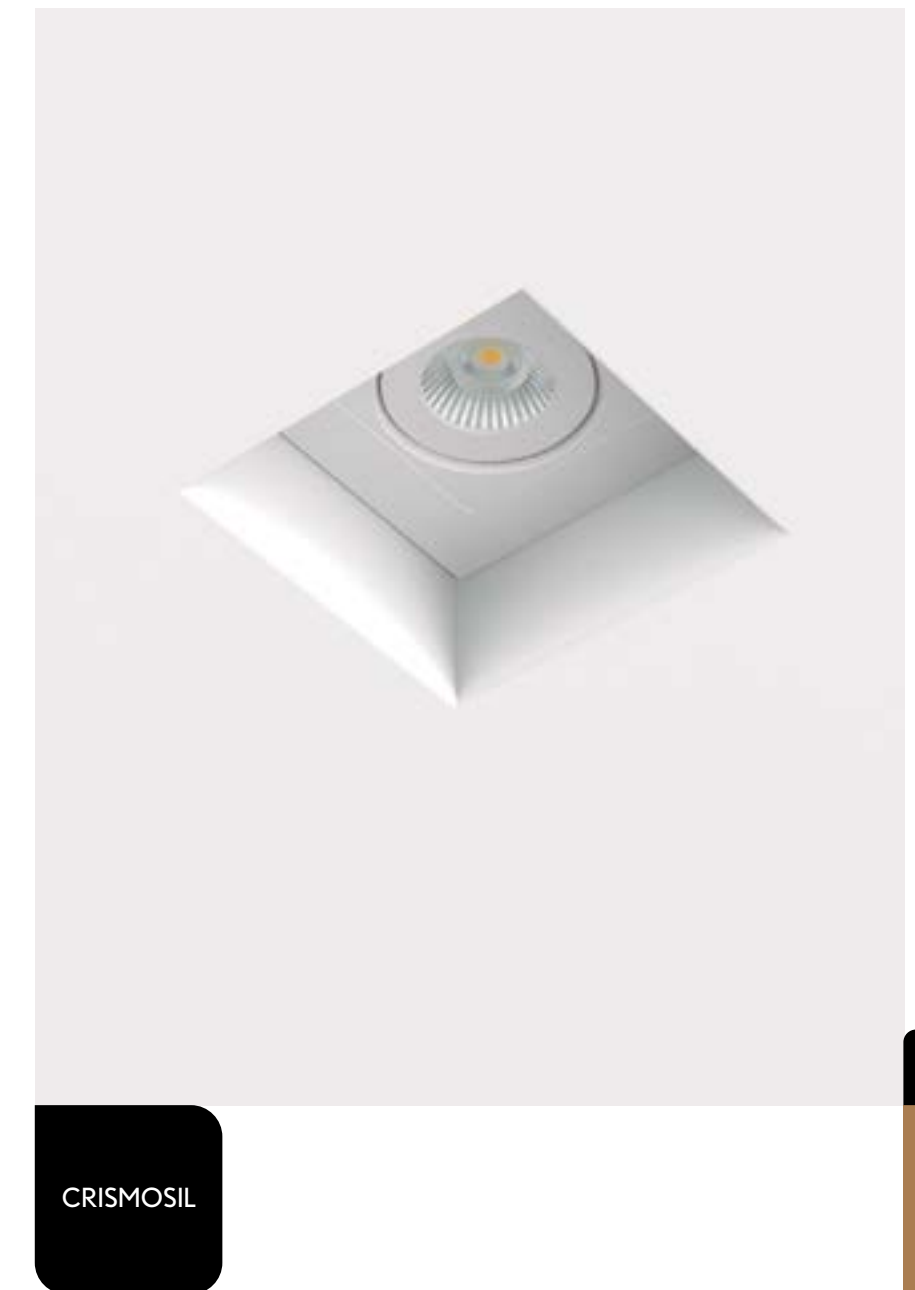

CRISMOSIL

.TR

TRIMLESS

10 - 20 mm * Espesor del falso techo
Ceiling thickness

13 mm * Espesor del falso techo
Ceiling thickness

LUMINAIRE INCLUDES

Reference order

10028.XX.TR.WH-WH.XX.XX.XXX.XX.XX

Recessed with frame mounting kit

VEGA

REF 10028.TR

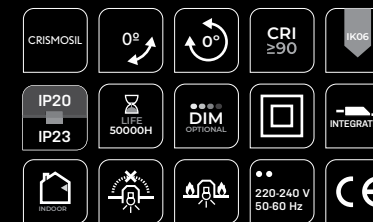

PHOTOMETRY

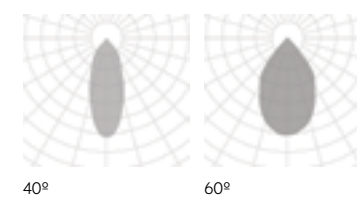



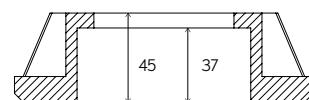



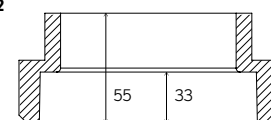





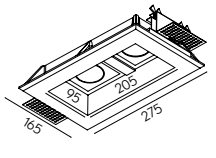

10028.01



10028.02

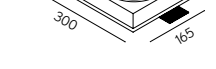

VEGA TWINS	REF.	DIMENSIONS	FINISHES	LAMP	OPTIC OPTIONS	POWER	CRI	K	LUMEN	WATT	mA	DIMM	SKETCH					
 	10070	.01	.WH-WH	GU5.3		GU5.3	.9	-	1052	Max 2x8	-	-	  					
				GU10	.GU	GU10												
				LED	.40 .60	   								.27	1140	16	350	.DA .PU .D1
														.30	1422			
														.27	1414			
			.30	1854	20	500												
			.40	1534														

VEGA TWINS	REF.	DIMENSIONS	FINISHES	LAMP	OPTIC OPTIONS	POWER	CRI	K	LUMEN	WATT	mA	DIMM	SKETCH					
	10070	.02	.WH-WH	GU5.3		GU5.3	.9	-	3076	Max 2x20	-	-	   					
				GU10	.GU	GU10												
				GX8.5	.CD	GX8.5												
				LED	.40 .60	 								.27	3444	32	500	.DA .PU .D1
														.30	2710			
			.40															

10 - 20 mm * Espesor del falso techo
Ceiling thickness

13 mm * Espesor del falso techo
Ceiling thickness

LUMINAIRE INCLUDES

Reference order

10070.XX.TR.WH-WH.XX.XX.XXX.XXX.XX

Recessed with frame mounting kit

FINISHES



DIMENSIONS

.01 | .02

LIGHTING OPTIONS

BEAM ANGLE / LAMP

40° | 60° | GU5.3 | GU10 | GX8.5

POWER

STANDARD | HIGH

CRI

90

COLOR TEMPERATURE

2700K | 3000K | 4000K

DIMMABLE OPTIONS

DALI | 1.10 | PUSH

LIGHT DISTRIBUTION

DOWN



CRISMOSIL

.TR

TRIMLESS

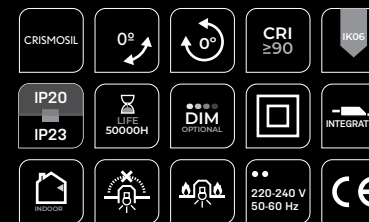

VEGA TWINS

REF 10070.TR

10070.01

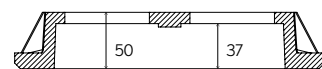

10070.02

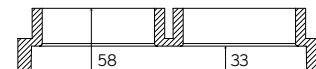

PHOTOMETRY

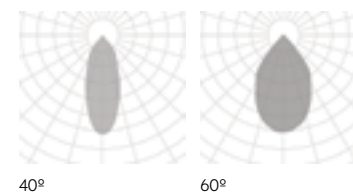

40°

60°

VEGA ZETA	REF.	DIMENSIONS	FINISHES	LAMP	OPTIC OPTIONS	POWER	CRI	K	LUMEN	WATT	mA	DIMM	SKETCH					
	10001	.01	.WH-WH	GU5.3	■	GU5.3	9	.27 .30 .40 .27 .30 .40	526	Max 20	-	-						
				GU10	■	GU10			8					350				
				LED	.40 .60	■			.ST BPM50	8				350	500	.DA .PU .D1		
																	.HI BPM200	711
																		707
																		927

10 - 20 mm * Espesor del falso techo
Ceiling thickness

LUMINAIRE INCLUDES

Recessed with frame mounting kit

Reference order | 10001.01.TR.WH-WH.XX.XX.X.XX.XX

FINISHES

□

DIMENSIONS

.01

LIGHTING OPTIONS

BEAM ANGLE / LAMP

40° | 60° | GU5.3 | GU10

POWER

STANDARD | HIGH

CRI

90

COLOR TEMPERATURE

2700K | 3000K | 4000K

DIMMABLE OPTIONS

DALI | 1.10 | PUSH

LIGHT DISTRIBUTION

DOWN

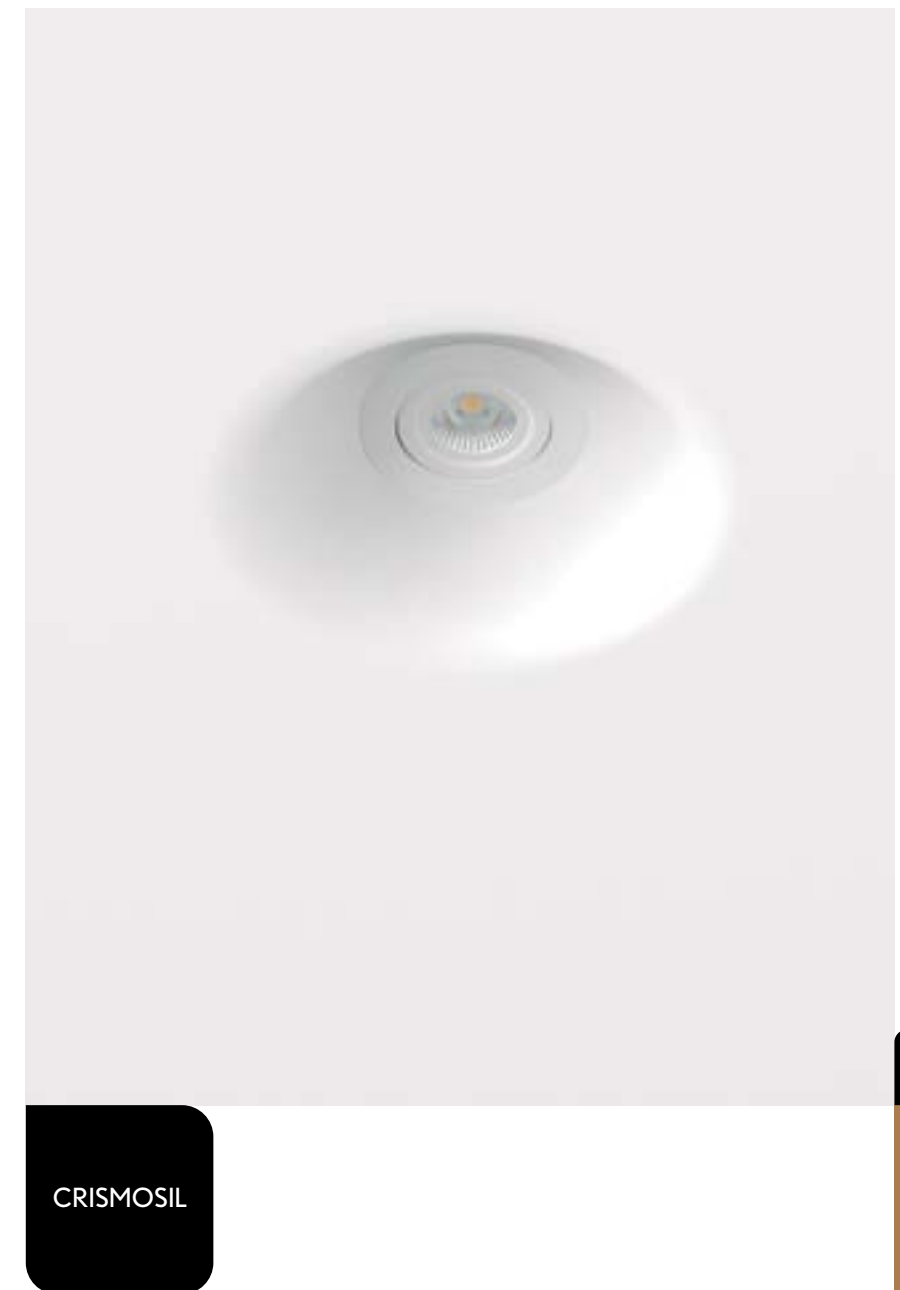

VEGA ZETA

REF 10001.TR

CRISMOSIL	45°	0°	CRI ≥90	IK08
IP20 IP23	LIFE 50000H	DIM OPTIONAL	INTEGRATED	
RECESSED			220-240 V 50-60 Hz	CE

PHOTOMETRY

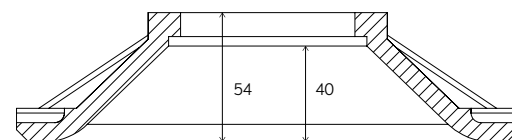
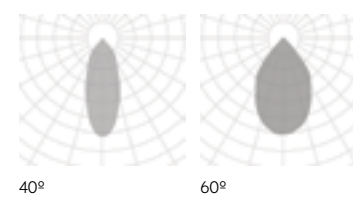

VEGA ZETA SQ	REF.	DIMENSIONS	FINISHES	LAMP	OPTIC OPTIONS	POWER	CRI	K	LUMEN	WATT	mA	DIMM	SKETCH			
	10019	.01	.WH-WH	GU5.3		GU5.3	.9	-	526	Max 8	-	.DA .PU .D1				
				GU10	.GU	GU10										
				LED	.40 .60	.ST BPM50				.27				526	8	350
										.30				570		
										.40				711		
										.27				707		
.HI BPM300	.30	927	10	500												
	.40	767														

VEGA ZETA SQ	REF.	DIMENSIONS	FINISHES	LAMP	OPTIC OPTIONS	POWER	CRI	K	LUMEN	WATT	mA	DIMM	SKETCH			
	10019	.02	.WH-WH	GU5.3		GU5.3	.9	-	1538	Max 20	-	.DA .PU .D1				
				GU10	.GU	GU10										
				GX8.5*	.CD	GX8.5				Max 20						
				LED	.40 .60	.ST BPM3181								.27	1538	16
										.30				1722		
										.HI BPM300				.40	1355	

10 - 20 mm ↑ * Espesor del falso techo Ceiling thickness

LUMINAIRE INCLUDES

Reference order

10019.XX.TR.WH-WH.XX.XXX.XXX.XX

Recessed with frame mounting kit

FINISHES



DIMENSIONS

.01 | .02

LIGHTING OPTIONS

BEAM ANGLE / LAMP

40° | 60° | GU5.3 | GU10 | GX8.5

POWER

STANDARD | HIGH

CRI

90

COLOR TEMPERATURE

2700K | 3000K | 4000K

DIMMABLE OPTIONS

DALI | 1.10 | PUSH

LIGHT DISTRIBUTION

DOWN



CRISMOSIL

TRIMLESS

* GX8.5 is Class I - GX8.5 es Clase I.

VEGA ZETA SQ

REF 10019.TR

CRISMOSIL	45°	350°	CRI ≥ 90	IK05
IP20 IP23	LIFE 50000H	DIM OPTIONAL	INTEGRATED	
RECESSED			220-240 V 50-60 Hz	CE

PHOTOMETRY

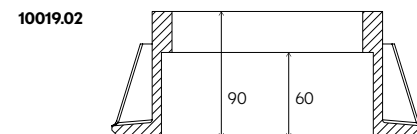
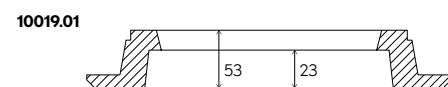
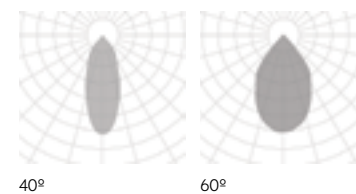

VEGA ZETA SQ TWINS	REF.	DIMENSIONS	FINISHES	LAMP	OPTIC OPTIONS	POWER	CRI	K	LUMEN	WATT	mA	DIMM	SKETCH
	10072	.02	.WH-WH	GU5.3		GU5.3	-	-	-	Max 2x20	-	-	
				GU10	.GU	GU10							
				GX8.5*	.CD	GX8.5							
				LED	.40 .60	.ST BPM3181	.9	.27 .30 .40	3076 3444 2710	32	500	.DA .PU .D1	

13 mm ↑ * Espesor del falso techo
Ceiling thickness

LUMINAIRE INCLUDES

Recessed with frame mounting kit

Reference order

10070.02.TR.WH-WH.XX.XX.X.XX.XX

FINISHES

□

DIMENSIONS

.02

LIGHTING OPTIONS

BEAM ANGLE / LAMP

40° | 60° | GU5.3 | GU10 | GX8.5

POWER

STANDARD | HIGH

CRI

90

COLOR TEMPERATURE

2700K | 3000K | 4000K

DIMMABLE OPTIONS

DALI | 1.10 | PUSH

LIGHT DISTRIBUTION

DOWN



CRISMOSIL

.TR

TRIMLESS

* GX8.5 is Class I - GX8.5 es Clase I.



VEGA ZETA SQ TWINS

REF 10072.TR

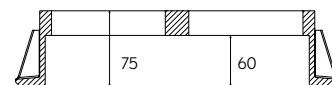

PHOTOMETRY

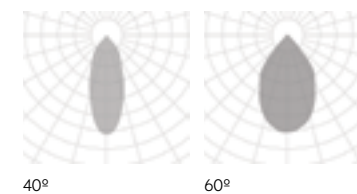

40°

60°

CENTAURO	REF.	DIMENSIONS	FINISHES	LAMP	OPTIC OPTIONS	POWER	CRI	K	LUMEN	WATT	mA	DIMM	SKETCH
	10109	.01	.WH-WH	LED	.40 .60	.ST	.9	.30	790	7	350	.DA .PU .D1	
								.40	796				

CENTAURO	REF.	DIMENSIONS	FINISHES	LAMP	OPTIC OPTIONS	POWER	CRI	K	LUMEN	WATT	mA	DIMM	SKETCH
	10109	.02	.WH-WH	LED	.40 .60	.ST	.9	.30	1840	20	540	.DA .PU .D1	
								.40	2010				

CENTAURO	REF.	DIMENSIONS	FINISHES	LAMP	OPTIC OPTIONS	POWER	CRI	K	LUMEN	WATT	mA	DIMM	SKETCH
	10109	.03	.WH-WH	LED	.40 .60	.ST	.9	.30	3200	40	750	.DA .PU .D1	
								.40	3320				

10 - 20 mm ↑ * Espesor del falso techo
Ceiling thickness

LUMINAIRE INCLUDES

Recessed with frame mounting kit

Reference order

10109.XX.TR.WH-WH.XX.XX.X.XX.XX

FINISHES



DIMENSIONS

.01 | .02 | .03

LIGHTING OPTIONS

BEAM ANGLE

40° | 60°

POWER

STANDARD | HIGH

CRI

90

COLOR TEMPERATURE

2700K | 3000K | 4000K

DIMMABLE OPTIONS

DALI | 1.10 | PUSH

LIGHT DISTRIBUTION

DOWN



CRISMOSIL

.TR

TRIMLESS

CENTAURO

REF 10109.TR



PHOTOMETRY

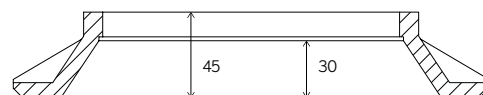
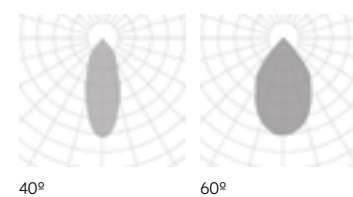

TRACK

VISUAL INDEX

PATRICIA TK



MARTORELL



KLIMT



GEO



LUK



CUBE



ORACLE



ALBA





One design, endless solutions

With flair and imagination, some products offer boundless possibilities. One of these is Patricia, the epitome of versatility.

Simple designs that enhance every project and adapt to every need. What's the secret? The accessories - Honey comb, cross ring, barndoors, spot lenses, halves, extenders and ovals - designed to bring light into the dark, to create elliptical shapes, spotlight effects, to draw the eye to a specific place, and much more.

Un diseño, múltiples soluciones

Hay productos que, con la destreza necesaria, permiten amplias posibilidades de aplicación. Y hay productos como Patricia, que son en sí mismos la máxima expresión de versatilidad.

Modelos de estética sencilla pero diseñados para evolucionar y adaptarse a cada exigencia. ¿Cómo conseguirlo? Gracias a sus accesorios - Honey comb, cross Ring, aletas, lentes concentradas, medias, extensivas y ovals - pensados para dar solución a situaciones de deslumbramiento, conseguir formas de luz elípticas, focales, direccionar el interés sobre un punto...Y un largo etcétera.

PATRICIA TK

TRACK



new

FINISHES

COLOR



DIMENSIONS

DIAMETERS

.01 | .02 | .03 | .04

LIGHTING OPTIONS

BEAM ANGLE

15° | 24° | 36° | 45°
50° | 55°

POWER

STANDARD | HIGH (ONLY .03)

CRI

90

COLOR TEMPERATURE

2700K | 3000K | 4000K

DIMMABLE OPTIONS

DALI

LIGHT DISTRIBUTION

DOWN

ON DEMAND

Dim to Warm
Tunable White



UGR
<19

.TK

TRACKLIGHT

INSTALLATIONS

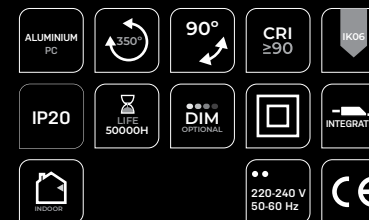

PATRICIA TK

REF 30514.TK



.TK
TRACKLIGHT

30514 PATRICIA TK | TK
Pag. 738

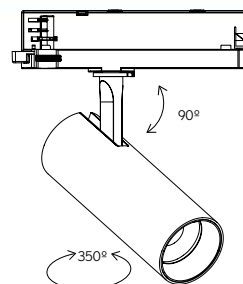

PATRICIA	REF.	DIMENSIONS	FINISHES	LAMP	OPTIC OPTIONS	POWER	CRI	K	LUMEN	WATT	mA	DIMM *1	SKETCH
	30514	.01	●	LED	.24 .36 .45 .55	.ST	.9	.27 .30 .40	713 752 919	10	250	.DA	
	30514	.02	●	LED	.24 .36 .45 .55	.ST	.9	.27 .30 .40	1110 1200 1250	15	350	.DA	
	30514	.03	●	LED	.15 .24 .36 .50	.ST .HI	.9	.27 .30 .40	1853 1912 1976 2221 2399 2470	25 32	600 750	.DA	
	30514	.04	●	LED	.15 .24 .36 .50	.ST	.9	.27 .30 .40	3135 3584 3910	42	1050	.DA	

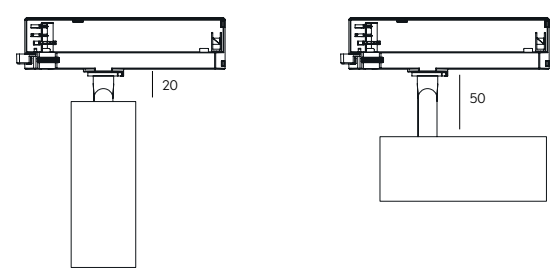

Reference order **30514.XX.TK.XX.XX.XX9.XX.XX**

ACCESORIES



BARN DOOR	DIMENSIONS				FINISHES					
ACC30514					.WH .BK					
	.01	Ø45x130	.02	Ø55			.03	Ø69	.04	Ø82

ACC30514.XX.BD.XX



CROSS RING	DIMENSIONS				FINISHES					
ACC30514					.WH .BK					
	.01	Ø45x130	.02	Ø55			.03	Ø69	.04	Ø82

ACC30514.XX.CR.XX



HONEY COMB	DIMENSIONS				FINISHES					
ACC30514					.BK-BK					
	.01	Ø45x130	.02	Ø55			.03	Ø69	.04	Ø82

ACC30514.XX.HC.XX

*1 Dimming .DA incorporates DALI adapter (250-260mm long) and luminaire is Class I. / Regulación .DA incorpora adaptador DALI (250-260mm de largo) y la luminaria es Clase I.

● Select finishes

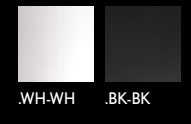

- ALUMINIUM PC
- 350°
- 90°
- CRI ≥90
- IP20
- LIFE 50000H
- DIM OPTIONAL
- INTEGRATED
- 220-240 V 50-60 Hz
- CE

PATRICIA TK

REF 30514.TK

PHOTOMETRY

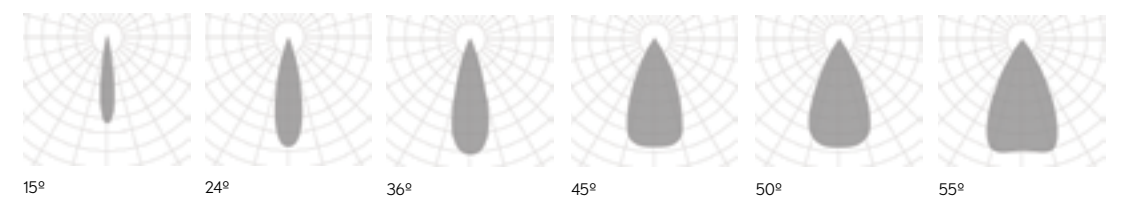

TRACKLIGHT



OVAL FLOOD LENS *1

ACC30514.XX.XXXX

OV. FLOOD LENS	DIMENSIONS	LENS EFFECT	OV. FLOOD LENS	DIMENSIONS	LENS EFFECT
ACC30514	.01	.OV.03X60		ACC30514	.OV.60X10
	.02				
	.03				
	.04				

OV. FLOOD LENS	DIMENSIONS	LENS EFFECT	OV. FLOOD LENS	DIMENSIONS	LENS EFFECT
ACC30514	.01	.OV.10X40		ACC30514	.OV.15X60
	.02				
	.03				
	.04				



ZOOM SPOT LENS *1

ACC30514.XX.XXXX

OV. FLOOD LENS	DIMENSIONS	LENS EFFECT	OV. FLOOD LENS	DIMENSIONS	LENS EFFECT
ACC30514	.01	.ZSX1.3		ACC30514	.ZSX1.5
	.02				
	.03				
	.04				

OV. FLOOD LENS	DIMENSIONS	LENS EFFECT	OV. FLOOD LENS	DIMENSIONS	LENS EFFECT
ACC30514	.01	.ZSX2		ACC30514	.ZSX3
	.02				
	.03				
	.04				

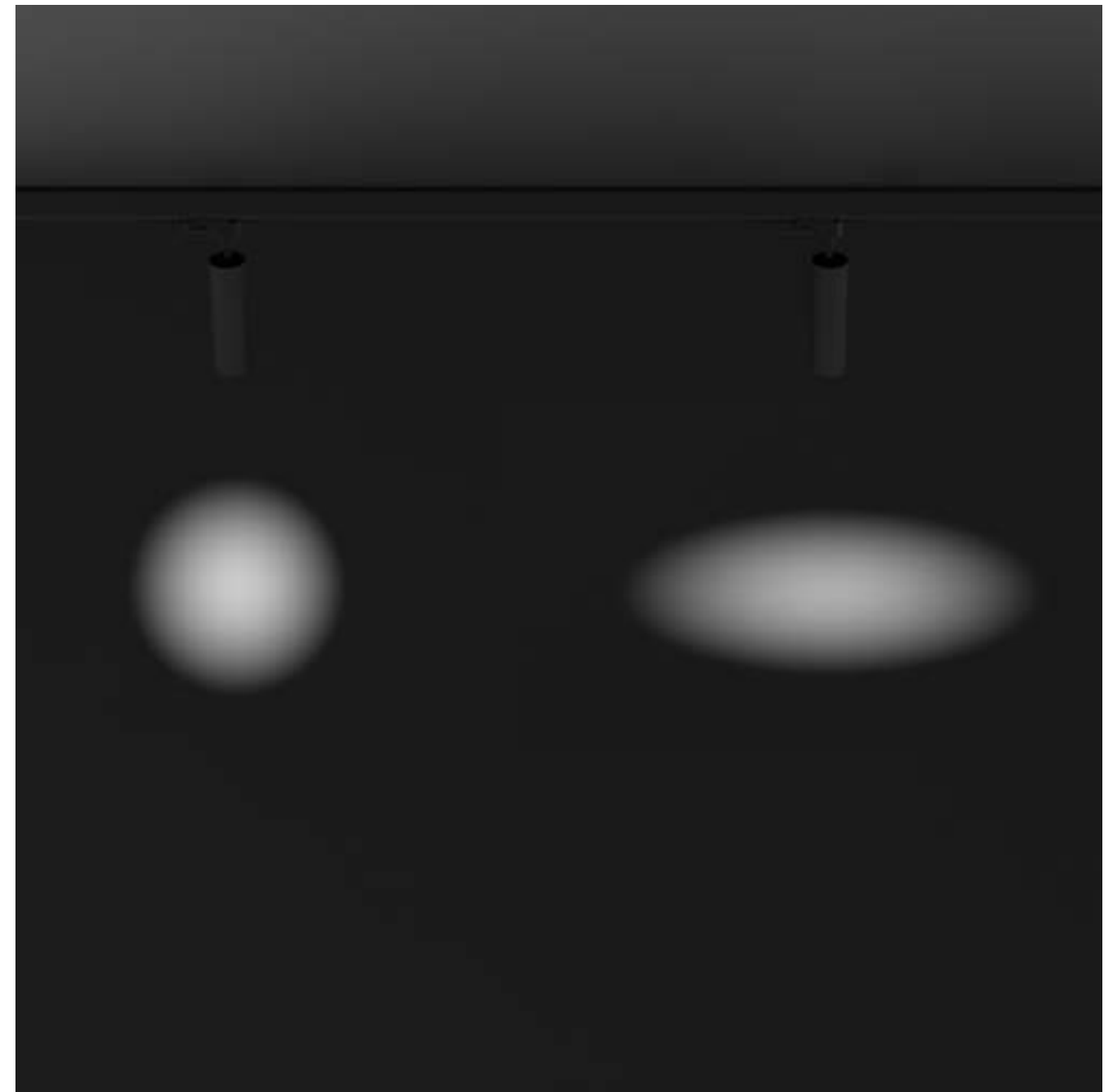

TRACKLIGHT
TK

- ALUMINUM PC
- 350°
- 90°
- CRI ≥90
- IK05
- IP20
- LIFE 50000H
- DIM OPTIONAL
- INTEGRATED
- INDOOR
- 220-240 V 50-60 Hz
- CE

PATRICIA TK

REF 30514.TK

*1For best performance, optic lenses are only recommended with the smallest option (.24 for models 01 & 02 and .15 for .03 and .04). Para garantizar un resultado óptimo, las lentes solo se recomiendan para la óptica de menor tamaño (.24 para los modelos 01 & 02 y .15 para .03 y .04).

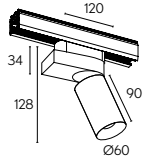
MARTORELL	REF.	DIMENSIONS	FINISHES	LAMP	OPTIC OPTIONS	POWER	CRI	K	LUMEN	WATT	mA	DIMM*	SKETCH
	20115	.03	●	LED	.24 .32	.ST	.9	.27 .30 .40	715 780 805	10	500	.DA .D1	

Reference order | 20115.03.TK.XX.XX.ST.9.XX.XX

FINISHES

EXTERNAL COLOR



INTERNAL COLOR



DIMENSIONS

View in family specifications

.03

LIGHTING OPTIONS

BEAM ANGLE

24° | 32°

POWER

STANDARD

CRI

90

COLOR TEMPERATURE

2700K | 3000K | 4000K

DIMMABLE OPTIONS

DALI | 1.10

LIGHT DISTRIBUTION

DOWN

ON DEMAND

Dim to Warm
Tunable White
Honey Comb
Wireless Control Options
Special RAL Color



Select finishes

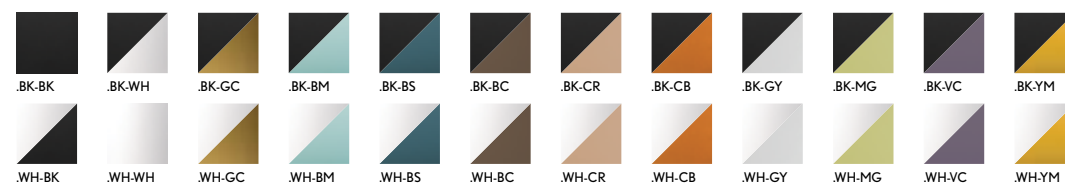

INSTALLATIONS

.PN
PENDANT

·20115 MARTORELL | PN
Pag. 322

.TK
TRACKLIGHT

·20115 MARTORELL | TK
Pag. 744

.SR
SURFACE

·20115 MARTORELL | SR
Pag. 322

.RF
RECESSED FRAME

·20115 MARTORELL | RF
Pag. 494

.TR
TRIMLESS

·20115 MARTORELL | TR
Pag. 676

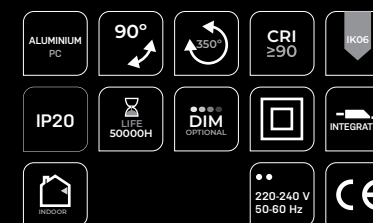

PHOTOMETRY

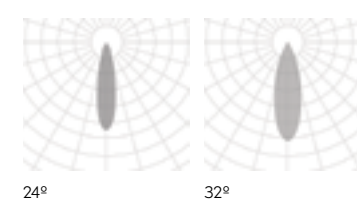

MARTORELL

REF 20115.TK



TRACKLIGHT

.TK

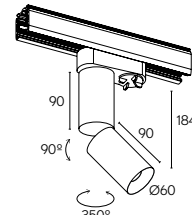
MARTORELL TUBE MOVE	REF.	DIMENSIONS	FINISHES	LAMP	OPTIC OPTIONS	POWER	CRI	K	LUMEN	WATT	mA	DIMM	SKETCH
	20138	.03	●	LED	.19 .24 .36	.ST	.9	.27 .30 .40	796 841 929	10	500	.DA*1 .D1*2	

Reference order | 20138.03.TK.XX.XX.ST9.XX.XX

*1 Dimmable .DA requires DALI adapter ACC6685
Regulación .DA requiere adaptador DALI ACC6685

*2 Dimmable .D1 requires driver box / Regulación .D1 requiere caja para alojar el driver

● Select finishes

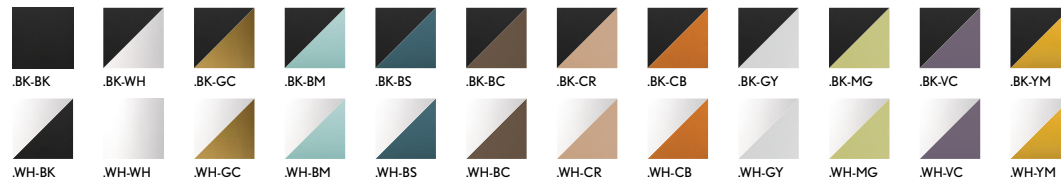

FINISHES

EXTERNAL COLOR



INTERNAL COLOR



DIMENSIONS

● View in family specifications

.01

LIGHTING OPTIONS

■ BEAM ANGLE

19° | 24° | 36°

POWER

STANDARD

CRI

90

COLOR TEMPERATURE

2700K | 3000K | 4000K

▼ DIMMABLE OPTIONS

DALI | 1.10

▲ LIGHT DISTRIBUTION

DOWN

ON DEMAND

Dim to Warm
Tunable White



INSTALLATIONS



.SR
SURFACE

·20138 MARTORELL TUBE MOVE | SR
Pag. 326

.TK
TRACKLIGHT

·20138 MARTORELL TUBE MOVE | TK
Pag. 746

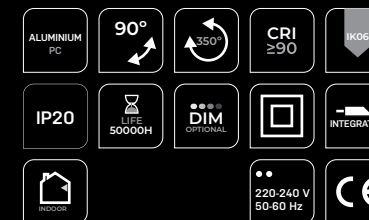



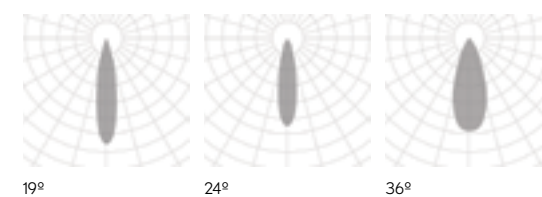

PHOTOMETRY

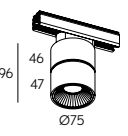

MARTORELL TUBE MOVE

REF 20138.TK

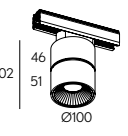

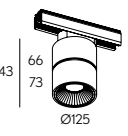
KLIMT	REF.	DIMENSIONS	FINISHES	LAMP	OPTIC OPTIONS	POWER	CRI	K	LUMEN	WATT	mA	DIMM*	SKETCH
	20134	.01	●	LED	.15 .24 .38	.ST	.9	.27	395	8	700	.DA** .D1**2	
.30								497					
.40								550					
	20134	.02	●	LED	.15 .24 .38 .60	.ST	.9	.27	803	11	500	.DA** .D1**2	
.30								983					
.40								991					
	20134	.03	●	LED	.15 .24 .38 .60	.ST	.9	.27	1945	30	700	.DA** .D1**2	
.30								2073					
.40								2311					

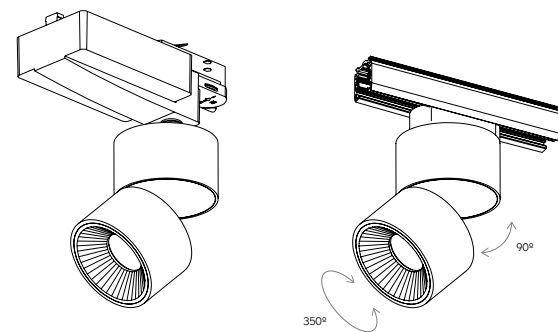

Reference order | 20134.XX.TK.XX.XX.ST9.XX.XX

PHOTOMETRY

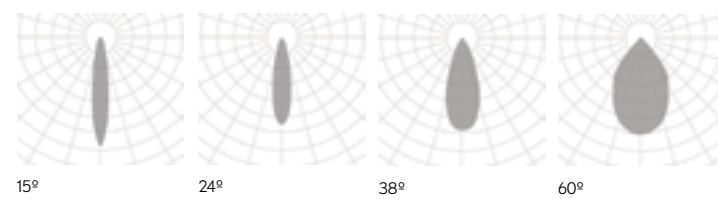

● Select external - internal finishes



*1 Dimmable .DA requires DALI adapter ACC6685
Regulación .DA requiere adaptador DALI ACC6685

*2 Dimmable .D1 requires driver box / Regulación .D1 requiere caja para alojar el driver

FINISHES

EXTERNAL COLOR



INTERNAL COLOR



DIMENSIONS

● View in family specifications

.01 | .02 | .03

LIGHTING OPTIONS

■ BEAM ANGLE

15° | 24° | 38° | 60°

POWER

STANDARD

CRI

90

COLOR TEMPERATURE

2700K | 3000K | 4000K

▼ DIMMABLE OPTIONS

DALI | 1.10

▲ LIGHT DISTRIBUTION

DOWN

ON DEMAND

Dim to Warm
Tunable White



INSTALLATIONS
INSTALACIONES



KLIMT

REF 20134.TK

.SR
SURFACE

·20134 KLIMT | SR
Pag. 338

.TK
TRACKLIGHT

·20134 KLIMT | TK
Pag. 748

.RF
RECESSED FRAME

·20134 KLIMT | RF
Pag. 508



TRACKLIGHT

.TK

new

GEO	REF.	DIMENSIONS	FINISHES	LAMP	OPTIC OPTIONS	POWER	CRI	K	LUMEN	WATT	mA	DIMM*	SKETCH
	30511	.01	●	LED	.15 .24 .38	.ST	.9	.27 .30 .40	498 513 622	8	700	.DA*1 .D1*2	
	30511	.02	●	LED	.15 .25 .38 .60	.ST	.9	.27 .30 .40	1075 1114 1319	14	500	.DA*1 .D1*2	
	30511	.03	●	LED	.15 .28 .40 .60	.ST	.9	.27 .30 .40	1856 1963 2529	30	700	.DA*1 .D1*2	

Reference order | 30511.XX.TK.XX.XX.ST9.XX.XX

PHOTOMETRY

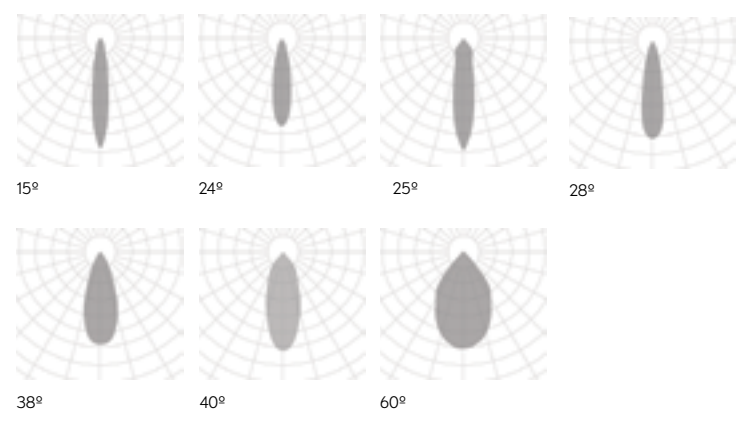

● Select external - internal finishes

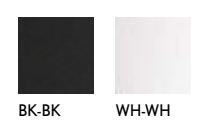

*1 Dimmable .DA requires DALI adapter ACC6685
Regulación .DA requiere adaptador DALI ACC6685
*2 Dimmable .D1 requires driver box
Regulación .D1 requiere caja para alojar el driver

FINISHES

COLORS

DIMENSIONS

View in family specifications
.01 | .02 | .03

LIGHTING OPTIONS

BEAM ANGLE
15° | 24° | 25° | 28° | 38° | 40° | 60°

POWER
STANDARD

CRI
90

COLOR TEMPERATURE
2700K | 3000K | 4000K

DIMMABLE OPTIONS
DALI | 1.10

LIGHT DISTRIBUTION
DOWN

ON DEMAND

Dim to Warm
Tunable White



INSTALLATIONS

- .SR SURFACE**
-30511GEO|SR
Pag. 342
- .TK TRACKLIGHT**
-30511GEO|TK
Pag. 750
- .RF RECESSED FRAME**
-30511GEO|RF
Pag. 512

GEO

REF 30511.TK

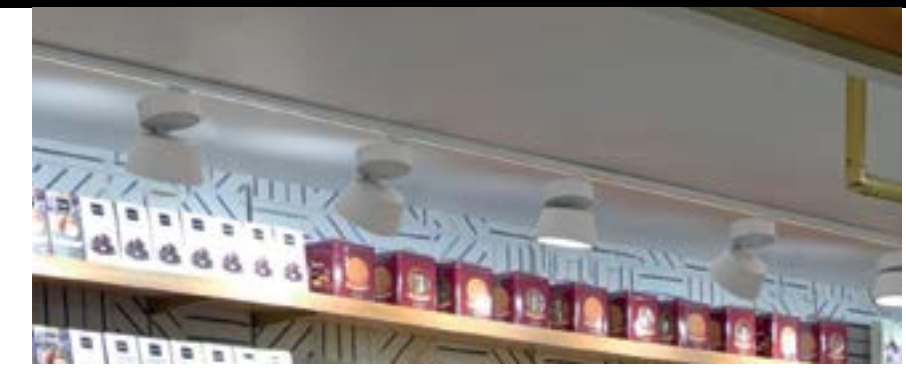

TRACKLIGHT

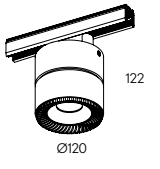
LUK CRUSADER	REF.	DIMENSIONS	FINISHES	LAMP	OPTIC OPTIONS	POWER	CRI	K	LUMEN	WATT	mA	DIMM	SKETCH
	20082	.01	●	LED	.24 .40 .60	.ST	.9	.27	1633	20	700	.DA .D1	
.30								2138					
.40								2228					

Reference order

20082.01.TK.XX.XX.ST9.XX.XX

FINISHES

COLOR



DIMENSIONS

View in family specifications

.01

LIGHTING OPTIONS

BEAM ANGLE

24° | 40° | 60°

POWER

STANDARD

CRI

90

COLOR TEMPERATURE

2700K | 3000K | 4000K

DIMMABLE OPTIONS

DALI | 1.10

LIGHT DISTRIBUTION

DOWN

ON DEMAND

Dim to Warm
Tunable White



Select finishes

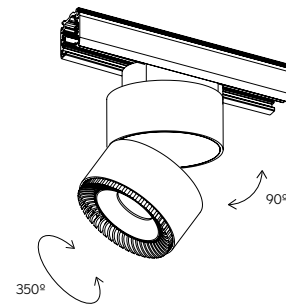
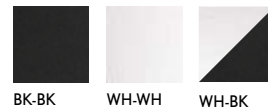

INSTALLATIONS

.SR
SURFACE

·20082 LUK CRUSADER | SR
Pag. 346

.TK
TRACKLIGHT

·20082 LUK CRUSADER | TK
Pag. 752

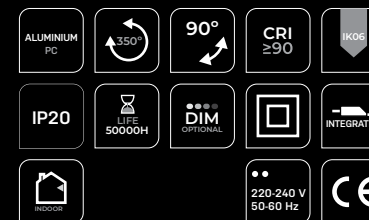

LUK CRUSADER

REF 20082.TK

PHOTOMETRY

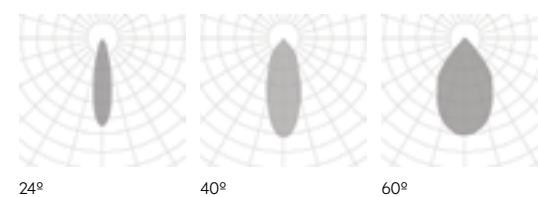

TRACKLIGHT

.TK

LUK HAWKEYE	REF.	DIMENSIONS	FINISHES	LAMP	OPTIC OPTIONS	POWER	CRI	K	LUMEN	WATT	mA	DIMM	SKETCH
	20083	.01	●	LED	.24 .40 .60	.ST	.9	.27	1689	27	700	.DA .D1	
								.30	2007				
								.40	2217				

Reference order | 20083.01.TK.XX.XX.ST9.XX.XX

LUK HAWKEYE 2	REF.	DIMENSIONS	FINISHES	LAMP	OPTIC OPTIONS	POWER	CRI	K	LUMEN	WATT	mA	DIMM	SKETCH
	20084	.01	●	LED	.24 .40 .60	.ST	.9	.27	4325	51	700	.DA .D1	
								.30	4565				
								.40	4706				

Reference order | 20084.01.TK.XX.XX.ST9.XX.XX

Select finishes

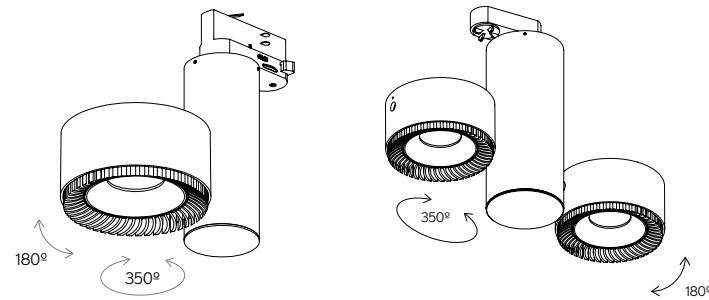

FINISHES

COLOR



DIMENSIONS

View in family specifications

.01

LIGHTING OPTIONS

BEAM ANGLE

24° | 40° | 60°

POWER

STANDARD

CRI

90

COLOR TEMPERATURE

2700K | 3000K | 4000K

DIMMABLE OPTIONS

DALI | 1.10

LIGHT DISTRIBUTION

DOWN

ON DEMAND

Dim to Warm
Tunable White



TRACKLIGHT

INSTALLATIONS



.SR
SURFACE

·20083 HAWKEYE ·20084 HAWKEYE 2|SR
Pag. 348



.TK
TRACKLIGHT

·20083 HAWKEYE ·20084 HAWKEYE 2|TK
Pag. 754

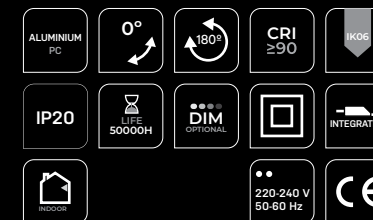

LUK HAWKEYE | HAWKEYE 2

REF 20083.TK | 20084.TK

PHOTOMETRY

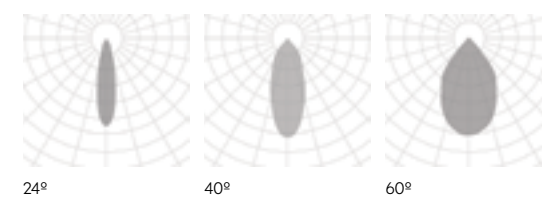

CUBE TUBE	REF.	DIMENSIONS	FINISHES	LAMP	OPTIC OPTIONS	POWER	CRI	K	LUMEN	WATT	mA	DIMM	SKETCH
	9050	.01	●	LED	.24 .40 .60	.ST	.9	.27 .30 .40	590 610 629	8	350	.DA .D1	
	9050	.02	●	LED	.24 .40 .60	.ST	.9	.27 .30 .40	590 610 629	8	350	.DA .D1	
	9050	.03	●	LED	.24 .40 .60	.ST	.9	.27 .30 .40	590 610 629	8	350	.DA .D1	
	9050	.04	●	LED	.24 .40 .60	.ST	.9	.27 .30 .40	590 610 629	8	350	.DA .D1	

Reference order | 9050.XX.TK.XX.XX.ST9.XX.XX

● Select finishes

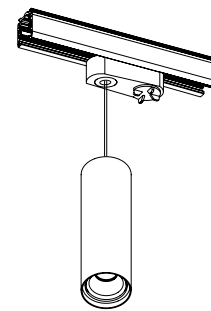
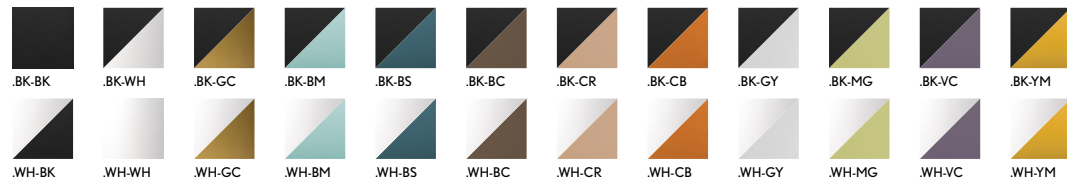

● FINISHES

EXTERNAL COLOR



INTERNAL COLOR



DIMENSIONS

● View in family specifications

.01 | .02 | .03 | .04

LIGHTING OPTIONS

■ BEAM ANGLE

24° | 40° | 60°

POWER

STANDARD

CRI

90

COLOR TEMPERATURE

2700K | 3000K | 4000K

▼ DIMMABLE OPTIONS

DALI | 1.10

▲ LIGHT DISTRIBUTION

DOWN

ON DEMAND

Dim to Warm
Tunable White



INSTALLATIONS

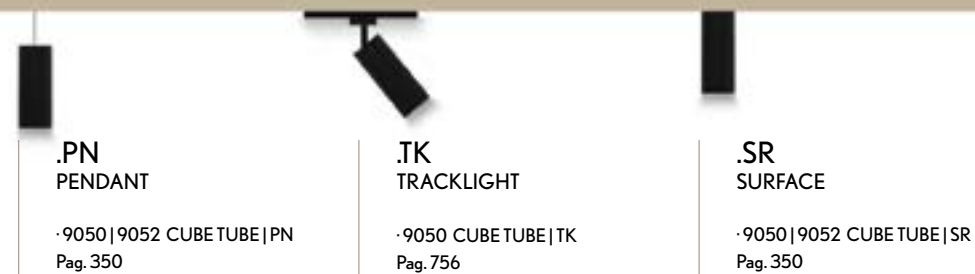

.PN
PENDANT

·9050|9052 CUBETUBE|PN
Pag. 350

.TK
TRACKLIGHT

·9050 CUBETUBE|TK
Pag. 756

.SR
SURFACE

·9050|9052 CUBETUBE|SR
Pag. 350

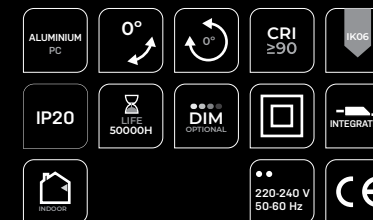

PHOTOMETRY

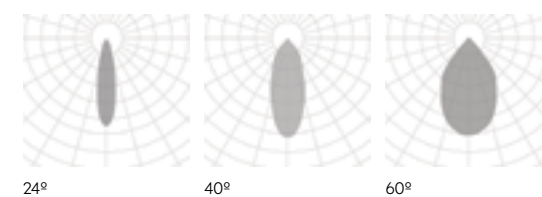

CUBE
TUBE

REF 9050.TK



TRACKLIGHT

.TK

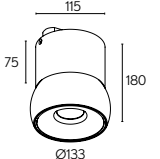
ORACLE	REF.	DIMENSIONS	FINISHES	LAMP	OPTIC OPTIONS	POWER	CRI	K	LUMEN	WATT	mA	DIMM*	SKETCH
	20087	.01	●	LED	.20 .40 .60	.ST	.9	.27 .30 .40	1079 1216 1273	14	500	.DA .D1	

Reference order |  20087.01TK.XX.XX.ST9.XX.XX

FINISHES

EXTERNAL COLOR



INTERNAL COLOR



DIMENSIONS

View in family specifications

.01 | .02

LIGHTING OPTIONS

BEAM ANGLE

20° | 40° | 60°

POWER

STANDARD

CRI

90

COLOR TEMPERATURE

2700K | 3000K | 4000K

DIMMABLE OPTIONS

DALI | 1.10

LIGHT DISTRIBUTION

DOWN

ON DEMAND

Dim to Warm
Tunable White



Select finishes

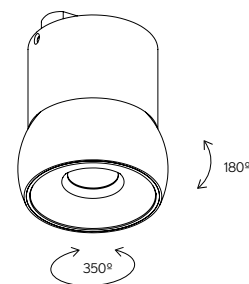
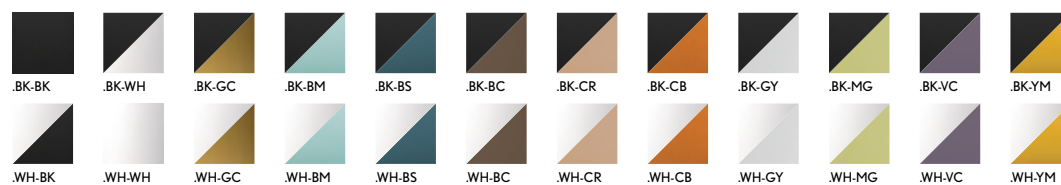

INSTALLATIONS

.PN
PENDANT

·20087 ORACLE|PN
Pag. 358

.TK
TRACKLIGHT

·20087 ORACLE|TK
Pag. 758

.SR
SURFACE

·20087 ORACLE|SR
Pag. 358

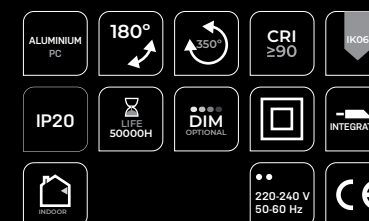

ORACLE

REF 20087.TK

PHOTOMETRY

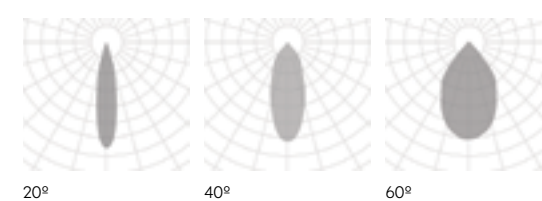

TRACKLIGHT

.TK

new

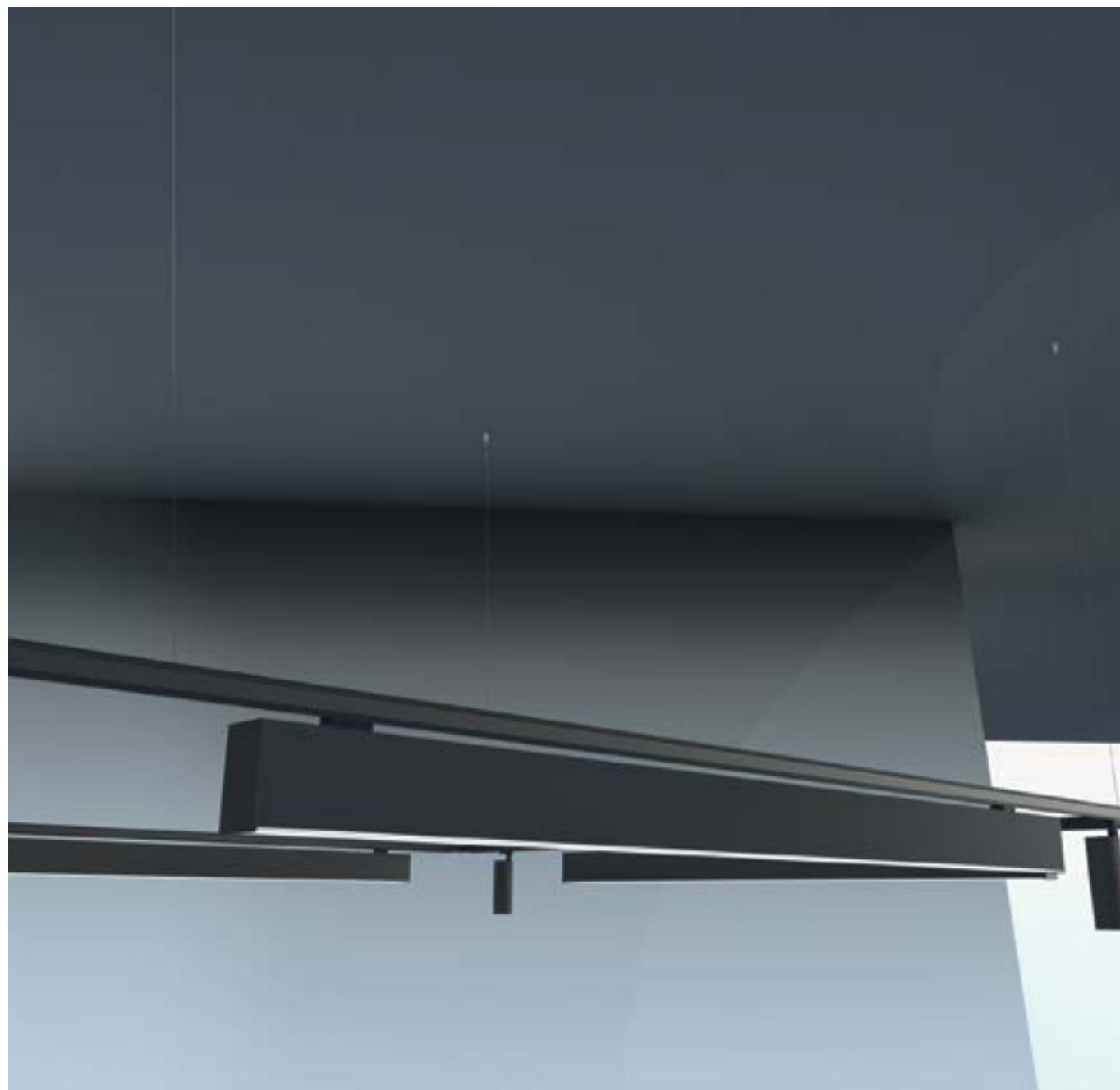

FINISHES

● COLORS



DIMENSIONS

◆ ELECTRIC SYSTEM LENGTH mm.

843 | 1124 | 1405 | 1686 | 1967 | 2248

LIGHTING OPTIONS

■ DIFFUSERS

OPAL | MICROPRISMATIC

POWER

STANDARD | HIGH

CRI

90

COLOR TEMPERATURE

2700K | 3000K | 4000K | TW

▼ DIMMABLE OPTIONS

DALI | 1.10 |

▲ LIGHT DISTRIBUTION

DOWN

LUMINAIRE INCLUDES

2 Track adapters



ON DEMAND

- Special RAL Color Emergency Lighting*
- Motion Detection
- Custom dimensions
- Special Color Temperature
- RGB
- Thematic LED
- Wireless Control Options (Casambi)
- CRI 80

* Delivered separately (not installed in luminaire).

TRACKLIGHT

INSTALLATIONS

.PN
PENDANT

·10160 ALBA | PN
Pag. 230

.WS
WALL SURFACE

·10160 ALBA | WS
Pag. 786

.TK
TRACK

·10160 ALBA | TK
Pag. 760

.SR
SURFACE

·10160 ALBA | SR
Pag. 230

.RF
RECESSED FRAME

·10160 ALBA | RF
Pag. 444

.TR
TRIMLESS

·10160 ALBA | TR
Pag. 644



ALBA

REF 10160.TK

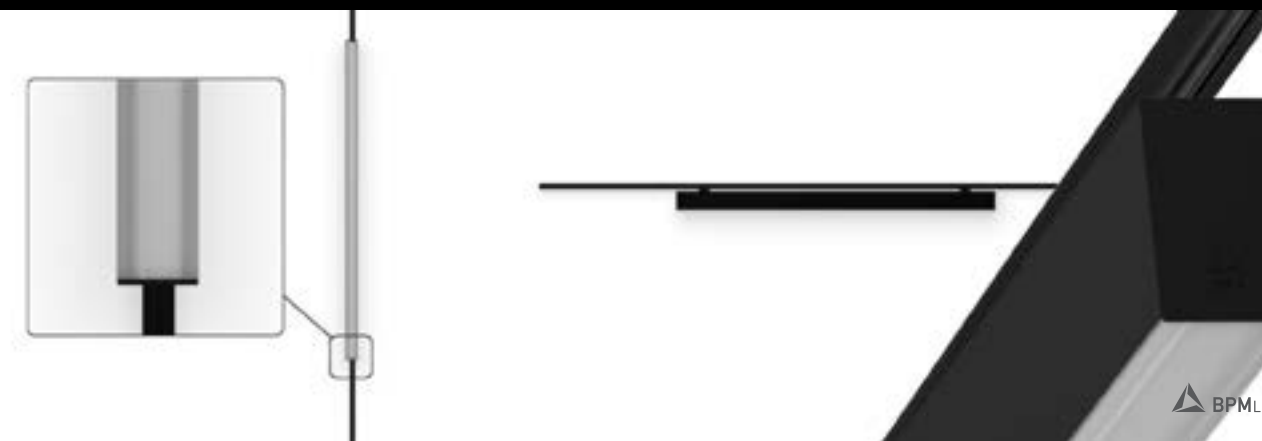

REF.	ELECTRIC SYSTEM LENGTH		FINISH	DIFFUSER	POWER	CRI	DOWNLIGHT *2 LUMEN				WATT		DIMM
	MM	MM					.27	.30	.40	.TW *1	K	TW	
10160	.03	843	●	.OP .MP	.ST	.9	2295	2385	2475	5700-5910	18	38	.DA .D1
	.04	1124					3060	3180	3300	7600-7880	24	51	
	.05	1405					3825	3975	4125	9500-9850	30	64	
	.06	1686					4590	4770	4950	11400-11820	36	76	
	.07	1967					5355	5565	5775	13300-13790	42	89	
	.08	2248					6120	6360	6600	15200-15760	48	102	

REF.	ELECTRIC SYSTEM LENGTH		FINISH	DIFFUSER	POWER	CRI	DOWNLIGHT *2 LUMEN			WATT	DIMM
	MM	MM					.27	.30	.40		
10160	.03	843	●	.OP .MP	.HI	.9	4590	4767	4956	36	.DA .D1
	.04	1124					6120	6356	6608	48	
	.05	1405					7650	7945	8260	60	
	.06	1686					9180	9534	9912	72	
	.07	1967					10710	11123	11564	84	
	.08	2248					12240	12712	13216	96	

Reference order | 10160.XX.TK.XX.XX.XX.XX.XX.XX

Total length = Electric System Length + 20mm + 2x3mm (Cover kit).

Select finishes



COMPONENTS

COVER KIT	REF.	FINISH
	TF02 2x3mm.	●

Reference order | TF02.TK.XX

REDUGER	REF.	POWER
	ACC.RG	.ST .HI

Reference order | ACC.RG.XX



TRACKLIGHT

ALBA

REF 10160.TK



PHOTOMETRY

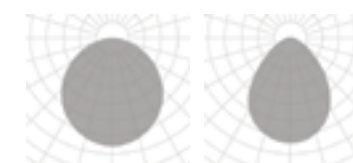

OPAL MICROPRISMATIC

INCLUDED



ACC.ADP

PROFILE

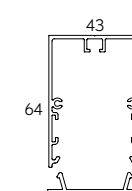

*1 Tunable White (TW) values correspond to 2700K and 6500K - TW is only available for DALI DT8 dimmable (.DA), CRI 80 (.8) 700mA. Los valores del blanco dinámico (TW) corresponden a 2700K y 6500K. -TW solo está disponible con protocolo DALI DT8 (.DA), CRI 80 (.8) 700mA.
*2 Down light (direct light) works at 500mA. La luz directa trabaja a 500mA.

new



FINISHES

● COLORS



DIMENSIONS

◆ ELECTRIC SYSTEM LENGTH mm.

843 | 1124 | 1405 | 1686 | 1967 | 2248

LIGHTING OPTIONS

■ DIFFUSERS

OPAL | MICROPRISMATIC

POWER

STANDARD | HIGH

CRI

90

COLOR TEMPERATURE

2700K | 3000K | 4000K | TW

▼ DIMMABLE OPTIONS

DALI | 1.10 |

▲ LIGHT DISTRIBUTION

DOWN

LUMINAIRE INCLUDES

Track adapter
Diffuser
Electric system



ON DEMAND

Special RAL Color
Emergency Lighting*
Motion Detection
Custom dimensions
Special Color Temperature
RGB
Thematic LED
Wireless Control Options (Casambi)
CRI 80

* Delivered separately
(not installed in luminaire).

TRACKLIGHT
TK

INSTALLATIONS



ALBA PLUS

REF 10178.TK

.PN
PENDANT

·10178 ALBA PLUS|PN
Pag. 246

.TK
TRACK

·10178 ALBA PLUS|TK
Pag. 764

.SR
SURFACE

·10178 ALBA PLUS|SR
Pag. 246

.RF
RECESSED FRAME

·10178 ALBA PLUS|RF
Pag. 452

.TR
TRIMLESS

·10178 ALBA PLUS|TR
Pag. 652

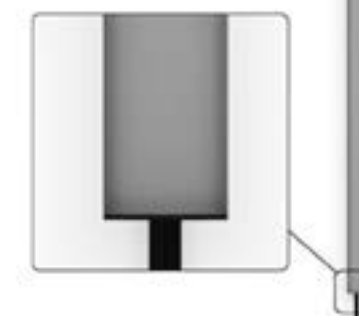

REF.	ELECTRIC SYSTEM LENGTH		FINISH	DIFFUSER	POWER	CRI	DOWNLIGHT *2 LUMEN				WATT		DIMM
	MM	MM					.27	.30	.40	.TW *1	K	TW	
10178	.03	843	●	.OP .MP	.ST	.9	2295	2385	2475	5700-8520	18	38	.DA .D1
	.04	1124					3060	3180	3300	7600-11360	24	51	
	.05	1405					3825	3975	4125	9500-14200	30	64	
	.06	1686					4590	4770	4950	11400-17040	36	76	
	.07	1967					5355	5565	5775	13300-19880	42	89	
	.08	2248					6120	6360	6600	15200-22720	48	102	

REF.	ELECTRIC SYSTEM LENGTH		FINISH	DIFFUSER	POWER	CRI	DOWNLIGHT *2 LUMEN			WATT	DIMM
	MM	MM					.27	.30	.40		
10178	.03	843	●	.OP .MP	.HI	.9	4590	4767	4956	36	.DA .D1
	.04	1124					6120	6356	6608	48	
	.05	1405					7650	7945	8260	60	
	.06	1686					9180	9534	9912	72	
	.07	1967					10710	11123	11564	84	
	.08	2248					12240	12712	13216	96	

Reference order | 10178.XX.TK.XX.XX.XX.XXX.XXX.XX

COMPONENTS

COVER KIT	REF.	FINISH
	TF01 2x3mm.	●

Reference order | TF01.TK.XX

REDUGER	REF.	POWER
	ACC.RG	.ST .HI

Reference order | ACC.RG.XX

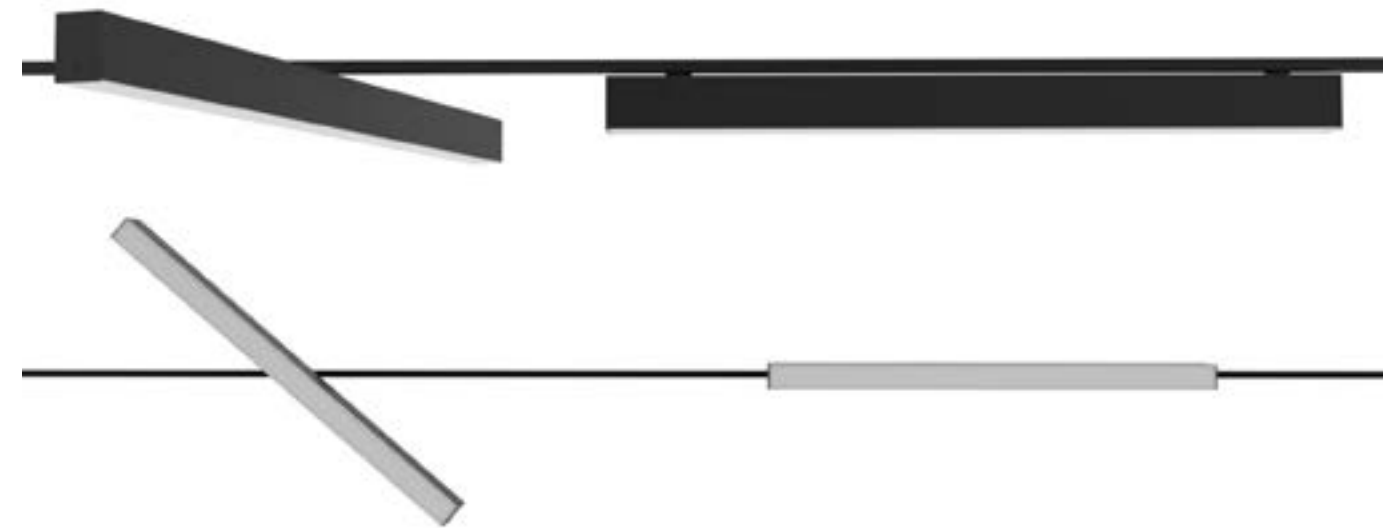

Total length = Electric System Length + 20mm + 2x3mm (Cover kit)

Select finishes

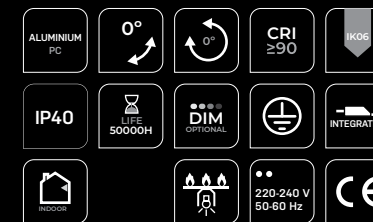

ALBA PLUS

REF 10178.TK

PHOTOMETRY

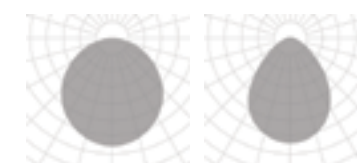

OPAL MICROPRISMATIC

INCLUDED



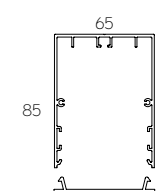

ACC.ADP

PROFILE

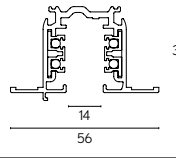

*1 Tunable White (TW) values correspond to 2700K and 6500K - TW is only available for DALI DT8 dimmable (.DA), CRI 80 (8) 700mA. Los valores del blanco dinámico (TW) corresponden a 2700K y 6500K. -TW solo está disponible con protocolo DALI DT8 (.DA), CRI 80 (8) 700mA.
*2 Down light (direct light) works at 500mA. La luz directa trabaja a 500mA.

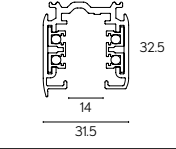
3-CIRCUIT TRACK	REF	DIMENSIONS	INST.	FINISH	DIMM.	SKETCH
	ACC6684	.01 1000	.RF	.BK-BK .GY-GY .WH-WH	.DA	
		.02 2000	.SR*			

* Add pendant mounting to track profile ACC6684.01.SR & ACC6684.02.SR with accessories ACC6666 + ACC6665.
 Añadir instalación colgante al perfil track ACC6684.01.SR & ACC6684.02.SR con los accesorios ACC6666 + ACC6665.

Reference order  ACC6684.XX.XX.XX

L-CORNER ADJUSTABLE	REF	FINISH	DIMM.
	ACC6660	.BK-BK .GY-GY .WH-WH	.DA

Reference order  ACC6660.XX.XX

L-CORNER	REF	FINISH	DIMM.
	ACC6659	.BK-BK .GY-GY .WH-WH	.DA

Reference order  ACC6659.XX.XX

T-ANGLE	REF	FINISH	DIMM.
	ACC6661	.BK-BK .GY-GY .WH-WH	.DA

Reference order  ACC6661.XX.XX

X-ANGLE	REF	FINISH	DIMM.
	ACC6662	.BK-BK .GY-GY .WH-WH	.DA

Reference order  ACC6662.XX.XX

MIDDLE FEED	REF	FINISH	DIMM.
	ACC6681	.BK-BK .GY-GY .WH-WH	.DA

Reference order  ACC6681.XX.XX

MIDDLE FEED	REF	FINISH	DIMM.
	ACC6682	.BK-BK .GY-GY .WH-WH	.DA

Reference order  ACC6682.XX.XX

POWER SUPPLY	REF	FINISH	DIMM.
	ACC6656	.BK-BK .GY-GY .WH-WH	.DA

Reference order  ACC6656.XX.XX

DALI ADAPTER	REF	FINISH
	ACC6685	.BK-BK .GY-GY .WH-WH

Reference order  ACC6685.XX

CONNECTOR COVER L	REF	FINISH
	ACC6687	.BK-BK .GY-GY .WH-WH

Reference order  ACC6687.XX

CONNECTOR COVER T	REF	FINISH
	ACC6686	.BK-BK .GY-GY .WH-WH

Reference order  ACC6686.XX

CONNECTOR COVER X	REF	FINISH
	ACC6664	.BK-BK .GY-GY .WH-WH

Reference order  ACC6664.XX

TRACK COVER STRIP 2M	REF	FINISH
	ACC6688	.BK-BK .WH-WH

Reference order  ACC6688.XX

BRACKET FOR PENDANT INST.	REF	FINISH
	ACC6665	.BK-BK .GY-GY .WH-WH

Reference order  ACC6665.XX

SUSPENSION KIT 5M	REF	FINISH
	ACC6666	.BK-BK .GY-GY .WH-WH

Reference order  ACC6666.XX

END CAP SR	REF	FINISH
	ACC6663	.BK-BK .GY-GY .WH-WH

Reference order  ACC6663.SR.XX

END CAP RF	REF	FINISH
	ACC6689	.BK-BK .GY-GY .WH-WH



Reference order  ACC6689.RF.XX

TOOL FOR ADAPTER WIRING	REF
	ACC6690

Reference order  ACC6690.XX

END CAP SR	REF	FINISH
	ACC6671	.BK-BK .WH-WH

Reference order  ACC6671.XX







THREADED ROD M6	TUBE FOR ROD	NUT M6
		
ACC6667	ACC6669	EXTENSION NUT M6 ACC6668 NUT THREADED ROD M6 ACC6670

TK ACCESORIES

WALL SURFACE

VISUAL INDEX

WALL LIGHTS

					
HURY 10251 PAG. 772	KUU 410014 PAG. 776	KAPI 9000 PAG. 778	IKI 9011 PAG. 780	OKUMA 8105 PAG. 782	ELENA 8106 PAG. 784

ALBA

		
ALBA 10160 PAG. 786	ALBA DOUBLE 10215 PAG. 790	ALBA ASIMETRIC 210009 PAG. 794

ACOUSTIC

	
ACOUSTIC ALZIRA 230002 PAG. 798	ACOUSTIC ACCESORIES AC.FL PAG. 802

WALL

					
WALL METIS 10098 PAG. 806	WALL ELARA 10097 PAG. 808	WALL TEBE 10096 PAG. 810	WALL LEDA 10051 PAG. 812	WALL ARCE 10055 PAG. 814	WALL CARPO 10059 PAG. 816

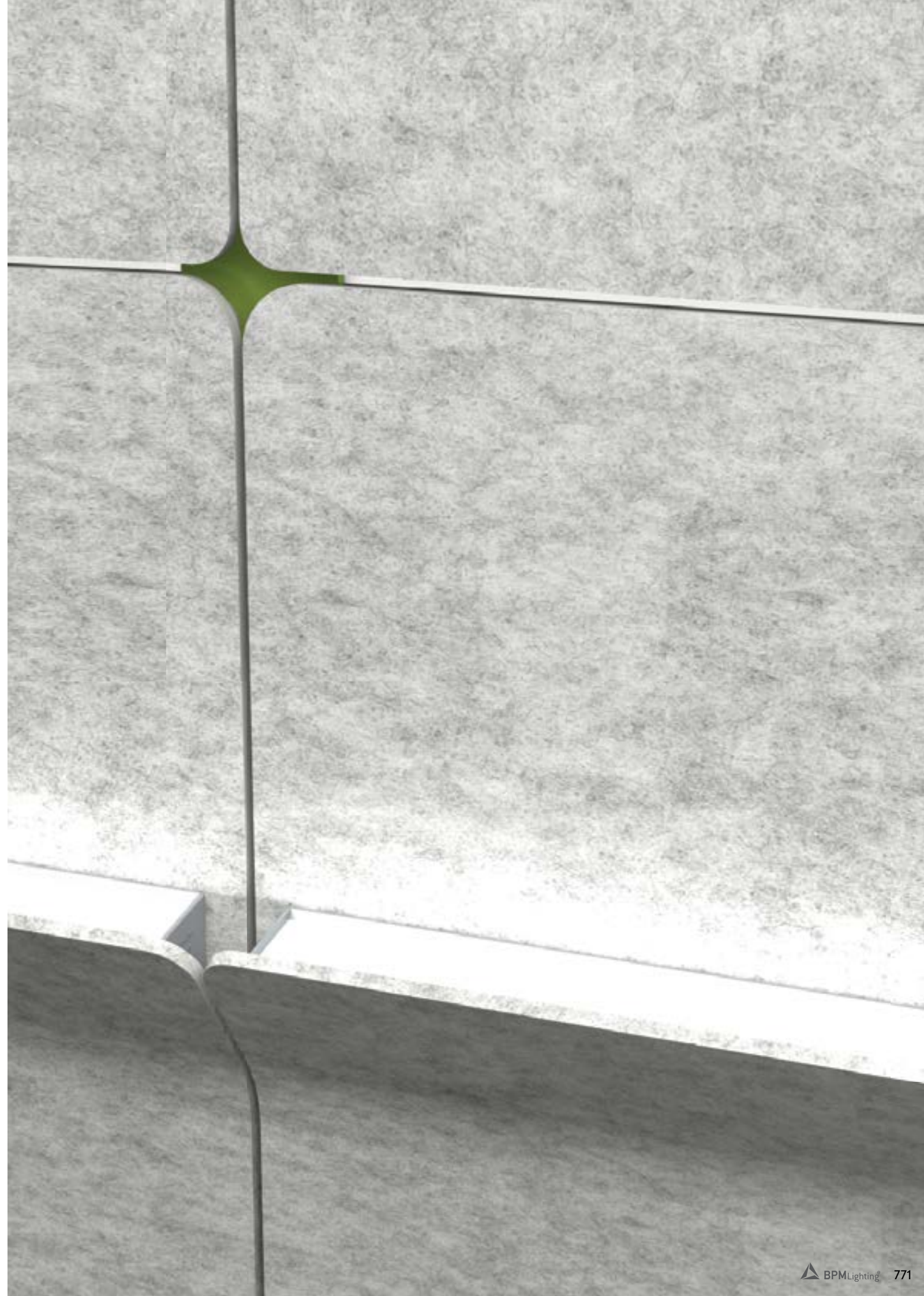



new

FINISHES

● COLORS



DIMENSIONS

◆ LENGTHS mm.

320 | 520 | 720

LIGHTING OPTIONS

■ DIFFUSERS

OPAL

POWER

STANDARD

CRI

90

COLOR TEMPERATURE

3000K

▼ DIMMABLE OPTIONS

DALI | 1.10 | PUSH

▲ LIGHT DISTRIBUTION

ADJUSTABLE

LUMINAIRE INCLUDES

Wall surface mounting kit



HURY	REF.	DIMENSIONS	FINISHES	LAMP	DIFFUSER	POWER	CRI	K	LUMEN	WATT	VdC	DIMM*1	SKETCH
	10251	.01	●	LED	.OP	.ST	.9	.30	1451	12	24	.DA .PU .D1	 320
	10251	.02	●	LED	.OP	.ST	.9	.30	2358	19	24	.DA .PU .D1	 520
	10251	.03	●	LED	.OP	.ST	.9	.30	3265	26	24	.DA .PU .D1	 720

● Select finishes



.WH-WH .BK-BK

Reference order | 10251.XX.WS.XX.OP.ST9.30.XX

*1 Remote driver when dimmable. Driver remoto cuando es dimable.

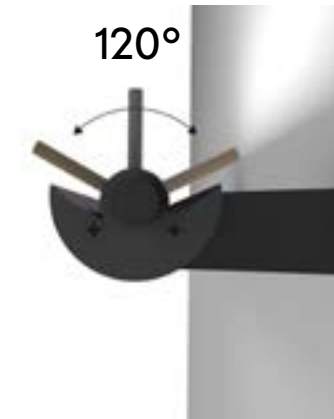

WALL SURFACE

INSTALLATIONS

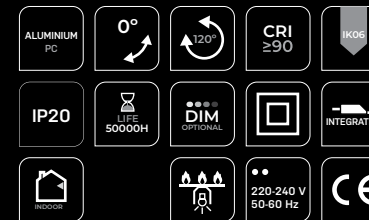

HURY

REF 10251.WS

.WS
WALL SURFACE

10251 HURY | WS
Pag. 772



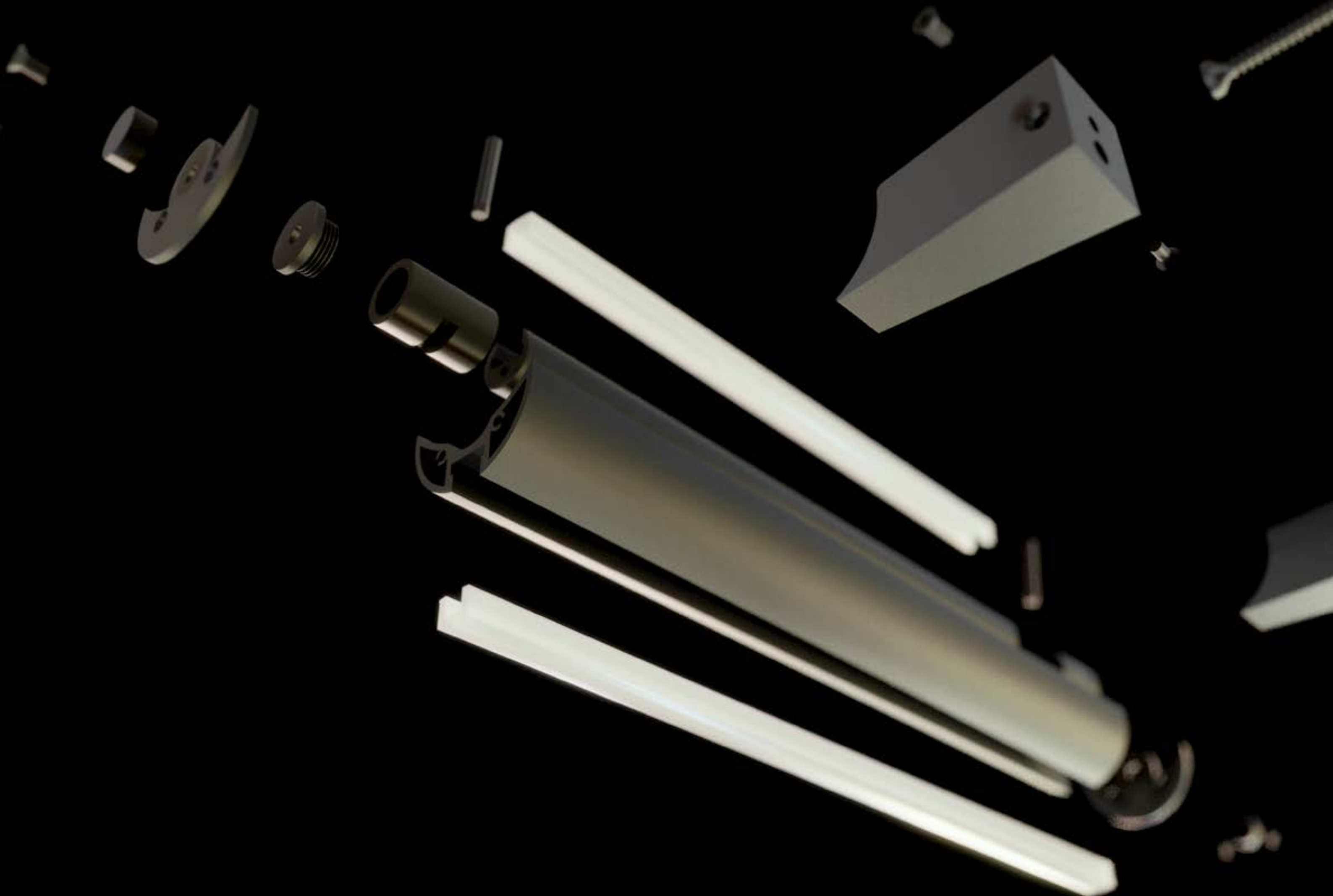

new

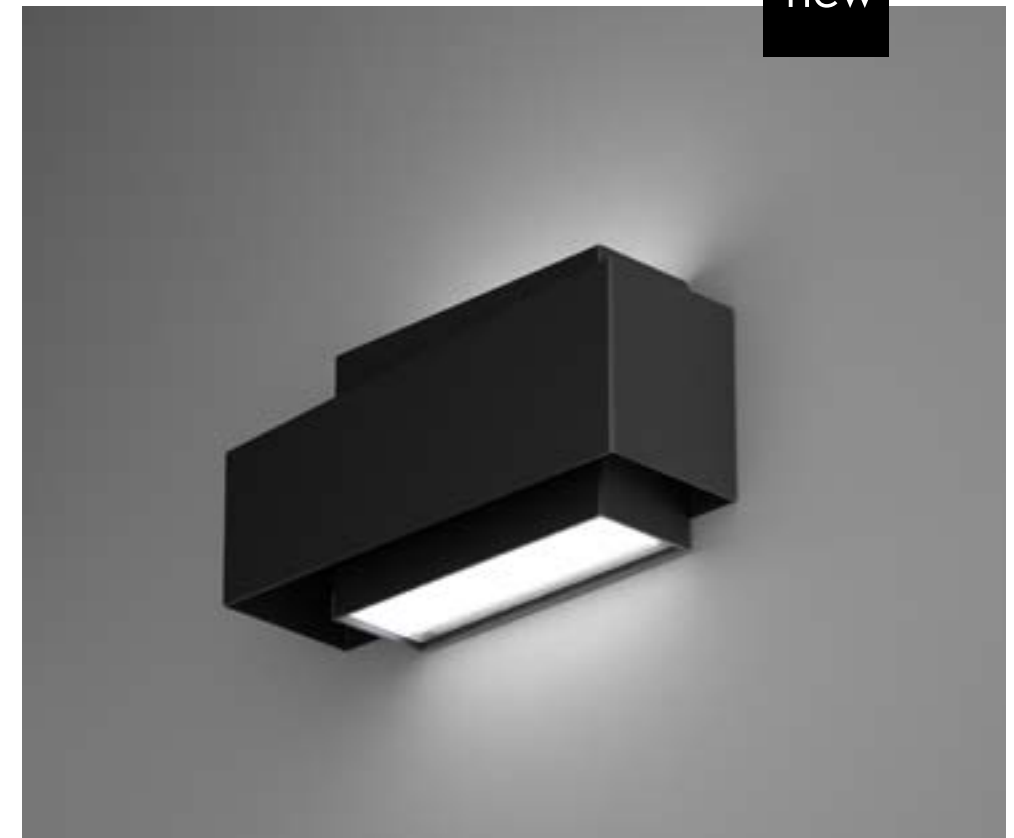

FINISHES

● COLORS



DIMENSIONS

◆ SIZES

.01

LIGHTING OPTIONS

■ DIFFUSERS

OPAL

POWER

STANDARD

CRI

90

COLOR TEMPERATURE

3000K

▼ DIMMABLE OPTIONS

-

▲ LIGHT DISTRIBUTION

UP - DOWN

LUMINAIRE INCLUDES

Wall surface mounting kit

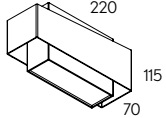
KUU	REF.	DIMEN-SIONS	FINISHES	LAMP	DIFFUSER	POWER	CRI	K	LUMEN	WATT	mA	DIMM	SKETCH
	410014	.01	●	LED	.OP	.ST	.9	.30	580	12	100	-	

Reference order

410014.01.WS.XX.OPST9.30

● Select finishes



.WH-WH .BK-BK

INSTALLATIONS

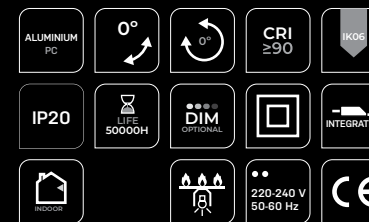

KUU

REF 410014.WS



.WS
WALL SURFACE

410014 KUU | WS
Pag. 776



WALL SURFACE



FINISHES

● COLORS



DIMENSIONS

◆ LENGTHS mm.

150 | 300 | 500

LIGHTING OPTIONS

■ DIFFUSERS

OPAL

POWER

STANDARD

CRI

90

COLOR TEMPERATURE

3000K

▼ DIMMABLE OPTIONS





▲ LIGHT DISTRIBUTION

UP - DOWN

LUMINAIRE INCLUDES

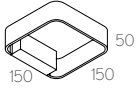
Wall surface mounting kit

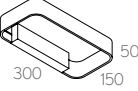

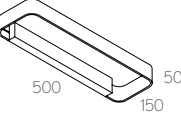
KAPI	REF.	DIMENSIONS ★	FINISHES ●	LAMP	DIFFUSER ■	POWER	CRI	K	LUMEN	WATT	mA	DIMM ▼	SKETCH
	9000	.01	.WH-WH	LED	.OP	.ST	.9	.30	250	3	350	-	
	9000	.02	.WH-WH	LED	.OP	.ST	.9	.30	500	5	350	-	
	9000	.03	.WH-WH	LED	.OP	.ST	.9	.30	1000	11	350	-	

Reference order | 9000.XX.WS.WH-WH.OP.ST.9.30.XX



KAPI

REF 9000.WS

.WS
WALL SURFACE

9000 KAPI | WS
Pag. 778

WS
WALL SURFACE

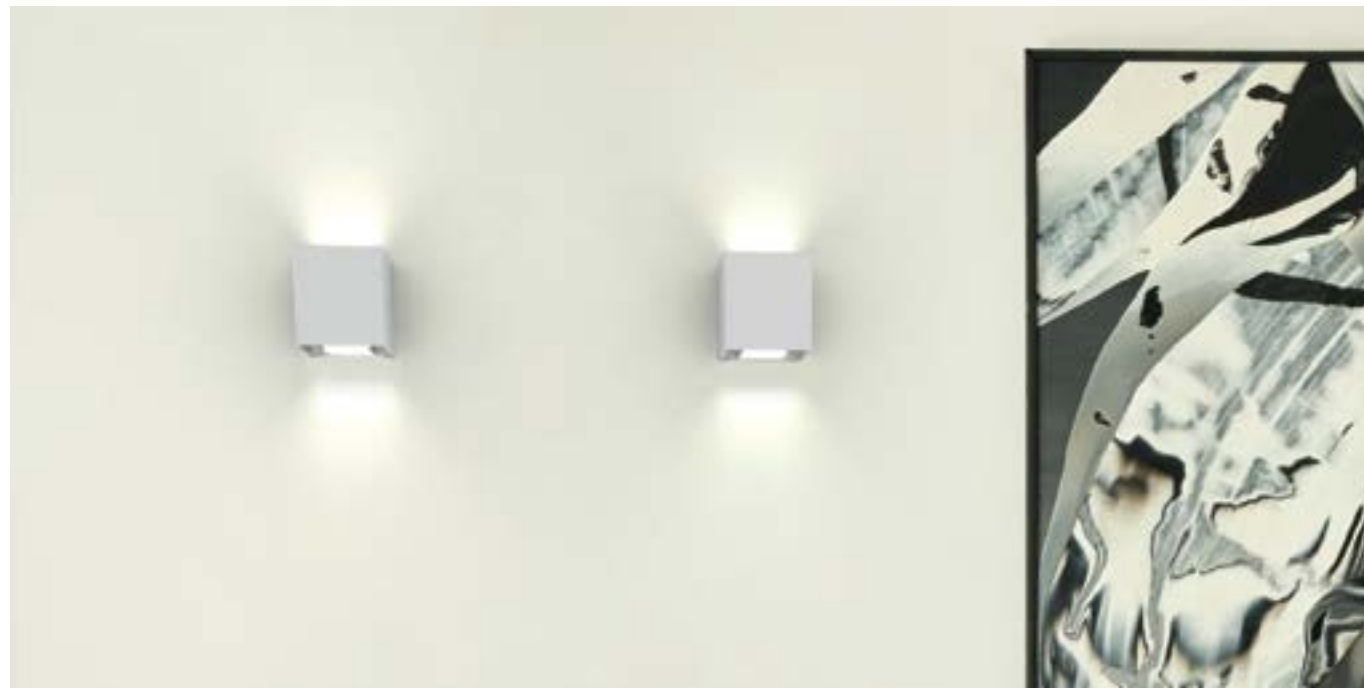

FINISHES

● COLORS



DIMENSIONS

◆ SIZES

.01

LIGHTING OPTIONS

■ DIFFUSERS

OPAL

POWER

STANDARD

CRI

80

COLOR TEMPERATURE

3000K

▼ DIMMABLE OPTIONS

-

▲ LIGHT DISTRIBUTION

UP - DOWN



IKI	REF.	DIMEN-SIONS	FINISHES	LAMP	OPTIC OPTIONS	POWER	CRI	K	LUMEN	WATT	mA	DIMM	SKETCH
	9011	.01	.WH-WH	LED	.OP	.ST	.9	.30	120	6	300	-	

Reference order

9011.01.WS.WH-WH.OP.ST9.XX

LUMINAIRE INCLUDES

Wall surface mounting kit

INSTALLATIONS



IKI

REF 9011.WS

.WS
WALL SURFACE

9011 IKI | WS
Pag. 780



.WS

WALL SURFACE



OKUMA	REF.	DIMENSIONS	FINISHES	LAMP	OPTIC OPTIONS	POWER	CRI	K	LUMEN	WATT	mA	DIMM	SKETCH
	8105	.01	●	LED	.OP	.ST	.9	.27	130	3	700	-	
							.30	140					
							.40	150					

Reference order | **8105.01.WS.XX.OP.ST9.XX**

● Select finishes

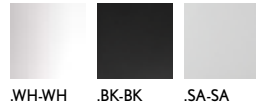

FINISHES

● COLORS



DIMENSIONS

◆ SIZES

.01

LIGHTING OPTIONS

■ DIFFUSERS

OPAL

POWER

STANDARD

CRI

90

COLOR TEMPERATURE

2700K | 3000K | 4000K

▼ DIMMABLE OPTIONS

-

▲ LIGHT DISTRIBUTION

ADJUSTABLE

LUMINAIRE INCLUDES

Wall surface mounting kit



INSTALLATIONS

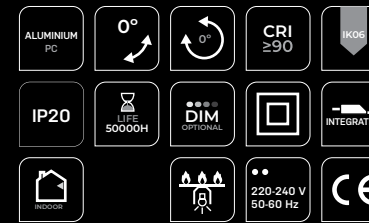

OKUMA

REF 8105.WS



.WS
WALL SURFACE

8105 OKUMA | WS
Pag. 782



FINISHES

● COLORS



DIMENSIONS

● SIZES

.01

LIGHTING OPTIONS

■ DIFFUSERS

OPAL

POWER

STANDARD

CRI

80

COLOR TEMPERATURE

3000

▼ DIMMABLE OPTIONS

-

▲ LIGHT DISTRIBUTION

AJUSTABLE

LUMINAIRE INCLUDES

Wall surface mounting kit

ELENA	REF.	DIMEN- SIONS	FINISHES	LAMP	DIFFUSER	POW- ER	CRI	K	LUMEN	WATT	mA	DIMM *	SKETCH
	8106	.01	●	LED	.OP	.ST	.8	.30	269	3	700	-	

Reference order 8106.01.WS.XX.OPST9.30

● Select finishes



INSTALLATIONS



ELENA

REF 8106.WS



.WS
WALL SURFACE

8106 ELENA | WS
Pag. 784



FINISHES

● COLORS



DIMENSIONS

● ELECTRIC SYSTEM LENGTH mm.

287 | 428 | 568

LIGHTING OPTIONS

■ DIFFUSERS

OPAL | MICROPRISMATIC

POWER

STANDARD | HIGH

CRI

90

COLOR TEMPERATURE

2700K | 3000K | 4000K | TW

▼ DIMMABLE OPTIONS

DALI | 1.10 | PUSH

▲ LIGHT DISTRIBUTION

DOWN

LUMINAIRE INCLUDES

Wall surface mounting kit
Cover Kit



ON DEMAND

Special RAL Color
Emergency Lighting*
Motion Detection
Custom dimensions
Special Color Temperature
RGB
Thematic LED
Wireless Control Options (Casambi)
CRI 80

* Delivered separately
(not installed in luminaire).

INSTALLATIONS

.PN
PENDANT

·10160 ALBA | PN
Pag. 230

.WS
WALL SURFACE

·10160 ALBA | WS
Pag. 786

.TK
TRACK

·10160 ALBA | TK
Pag. 760

.SR
SURFACE

·10160 ALBA | SR
Pag. 230

.RF
RECESSED FRAME

·10160 ALBA | RF
Pag. 444

.TR
TRIMLESS

·10160 ALBA | TR
Pag. 644



ALBA

REF 10160.WS

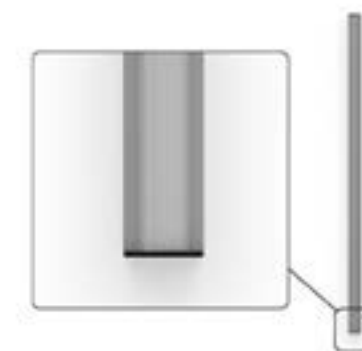

WS
WALL SURFACE

REF.	DIMENSION		FINISH	DIFFUSER	POWER	CRI	DOWNLIGHT *2 LUMEN				WATT		DIMM
	MM	MM					.27	.30	.40	.TW *1	K	TW	
10160	.01*3	287	●	.OP .MP	.ST	.9	765	795	825	1900-1970	6	13	.DA .PU .D1
	.02	428					1148	1193	1238	2850-2955	9	20	
	.03	568					1530	1590	1650	3800-3940	12	26	

REF.	DIMENSION		FINISH	DIFFUSER	POWER	CRI	DOWNLIGHT LUMEN			WATT		DIMM
	MM	MM					.27	.30	.40	K	TW	
10160	.01*3	287	●	.OP .MP	.HI	.9	1530	1589	1652	12		.DA .PU .D1
	.02	428					2295	2384	2478	18		
	.03	568					3060	3178	3304	24		

Reference order | 10160.XX.WS.XX.XX.XX.9.XX.XX

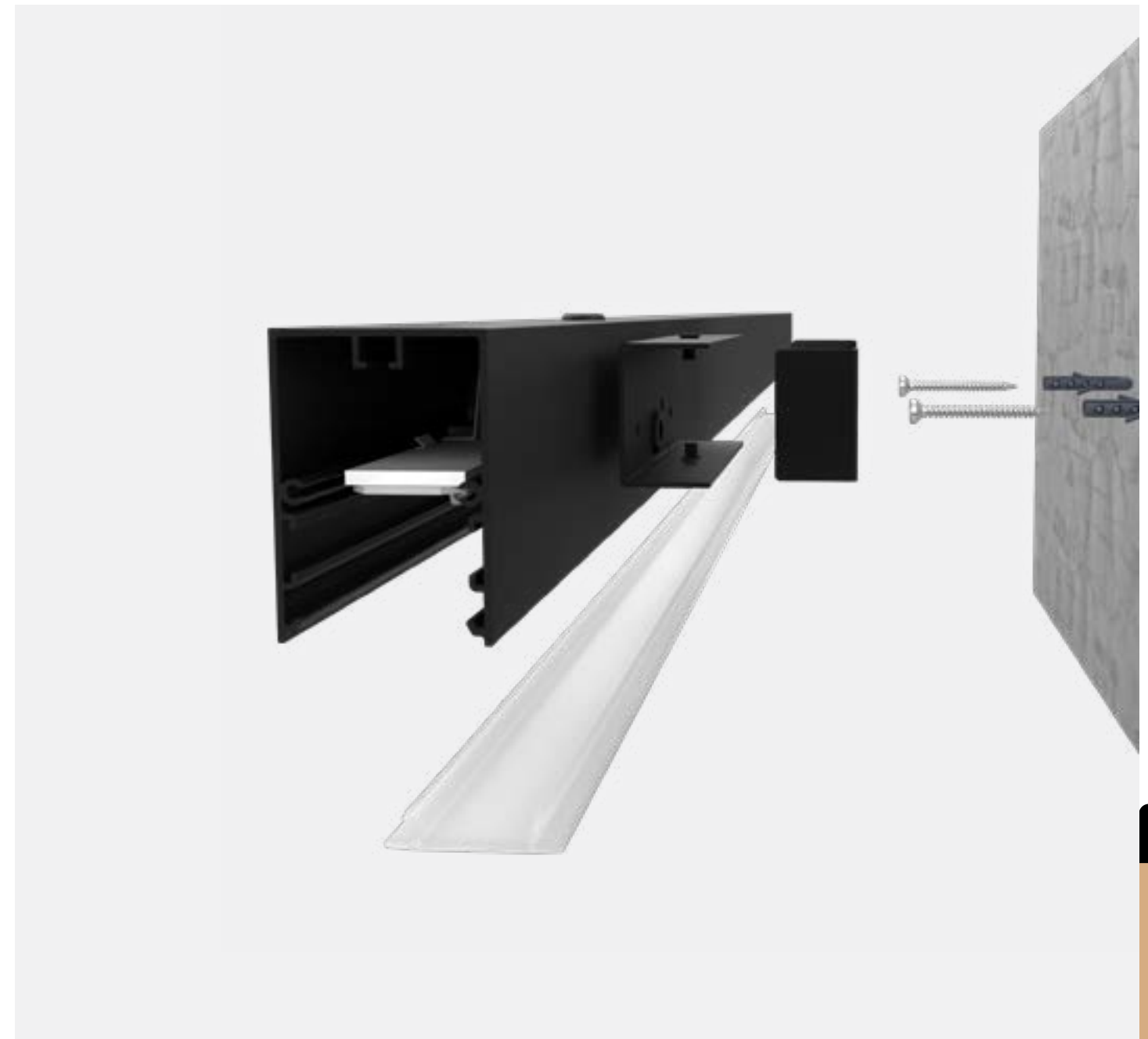

WS
WALL SURFACE

Select finish

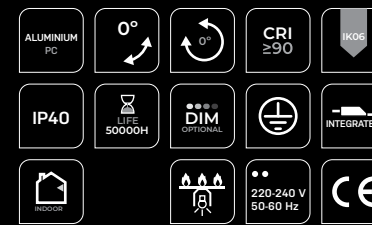

ALBA

REF 10160.WS

PHOTOMETRY

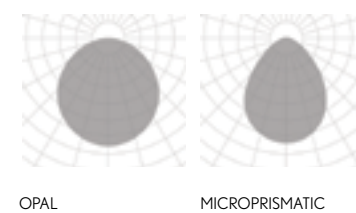

INCLUDED

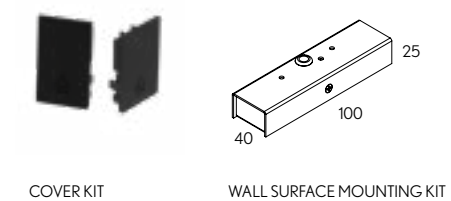

PROFILE

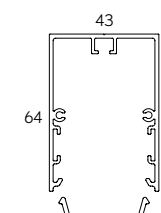

*1 Tunable White (TW) values correspond to 2700K and 6500K - TW is only available for DALI DT8 dimmable (DA), CRI 80 (8) 700mA. Los valores del blanco dinámico (TW) corresponden a 2700K y 6500K. -TW solo está disponible con protocolo DALI DT8 (DA), CRI 80 (8) 700mA.

*2 Down light (direct light) works at 500mA. La luz directa trabaja a 500mA.

*3 01 DIM - remote driver. 01 DIM requiere driver remoto.



FINISHES

● COLORS



DIMENSIONS

● ELECTRIC SYSTEM LENGTH mm.

331 | 472 | 612

LIGHTING OPTIONS

■ DIFFUSERS

OPAL | MICROPRISMATIC

POWER

STANDARD | HIGH

CRI

90

COLOR TEMPERATURE

2700K | 3000K | 4000K | TW

▼ DIMMABLE OPTIONS

DALI

▲ LIGHT DISTRIBUTION

UP - DOWN

LUMINAIRE INCLUDES

Wall surface mounting kit
Cover Kit



ON DEMAND

Special RAL Color
Emergency Lighting*
Motion Detection
Custom dimensions
Special Color Temperature
RGB
Thematic LED
Wireless Control Options (Casambi)
CRI 80
HI power

* Delivered separately
(not installed in luminaire).

INSTALLATIONS

.PN
PENDANT

·10215 ALBA DOUBLE | PN
Pag. 238

.WS
WALL SURFACE

·10215 ALBA DOUBLE | WS
Pag. 790



ALBA DOUBLE

REF 10215.WS

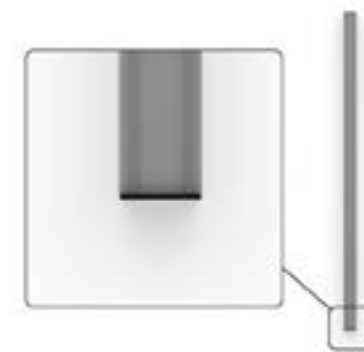

.WS

WALL SURFACE

REF.	DIMENSION		FINISH	DIFFUS-ER	POWER	CRI	DOWNLIGHT *2 LUMEN				WATT		UPLIGHT ▲.UP *2 LUMEN				WATT		DIMM ▼
	MM	MM					.27	.30	.40	.TW *1	K	TW	.27	.30	.40	.TW *1	K	TW	
10215	.01	331	●	.OP .MP	.ST	.9	765	795	825	1900-1970	6	13	765	795	825	1900-1970	6	13	.DA
	.02	472					1148	1193	1238	2850-2955	9	20	1148	1193	1238	2850-2955	9	20	
	.03	612					1430	1590	1650	3800-3940	12	26	1430	1590	1650	3800-3940	12	26	

Reference order | 10215.XX.WS.XX.XX.ST9.XX.XX.UP



WALL SURFACE

● Select finish

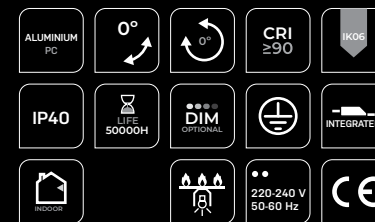
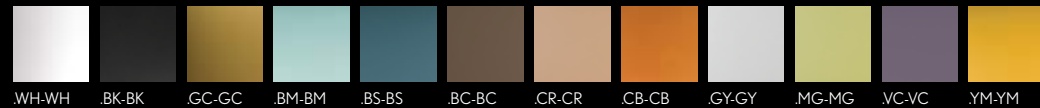

ALBA DOUBLE

REF 10215.WS

PHOTOMETRY



OPAL

MICROPRISMATIC

INCLUDED

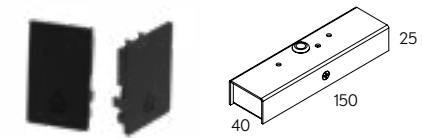

COVER KIT

WALL SURFACE MOUNTING KIT

PROFILE

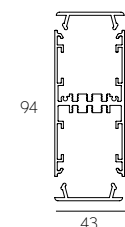

*1 Tunable White (TW) values correspond to 2700K and 6500K - TW is only available for DALI DT8 dimmable (DA), CRI 80 (8) 700mA. Los valores del blanco dinámico (TW) corresponden a 2700K y 6500K. - TW solo está disponible con protocolo DALI DT8 (DA), CRI 80 (8) 700mA.

*2 Down light (direct light) and up light (UP) work at 500mA. La luz directa e indirecta (UP) trabaja a 500mA.



FINISHES

EXTERNAL COLOR



INTERNAL COLOR



ELECTRIC SYSTEM LENGTH mm.

307 | 447 | 588

LIGHTING OPTIONS

DIFFUSERS

TRANSPARENT

POWER

STANDARD | HIGH

CRI

90

COLOR TEMPERATURE

2700K | 3000K | 4000K | TW

DIMMABLE OPTIONS

DALI | 1.10 | PUSH

LIGHT DISTRIBUTION

ASYMETRIC DOWN

LUMINAIRE INCLUDES

Wall surface mounting kit
Cover Kit



ON DEMAND

Special RAL Color
Emergency Lighting*
Special Color Temperature
RGB
Thematic LED
Wireless Control Options (Casambi)
CRI 80

* Delivered separately
(not installed in luminaire).

.WS

WALL SURFACE

INSTALLATIONS



ALBA ASIMETRIC

REF 210009.WS

.PN
PENDANT

·210009 ALBA ASIMETRIC
| PN - Pag. 242

.WS
WALL SURFACE

·210009 ALBA ASIMETRIC
| WS - Pag. 794

.SR
SURFACE

·210009 ALBA ASIMETRIC
| SR - Pag. 242

.RF
RECESSED FRAME

·210009 ALBA ASIMETRIC
| RF - Pag. 448

.TR
TRIMLESS

·210009 ALBA ASIMETRIC
| TR - Pag. 648

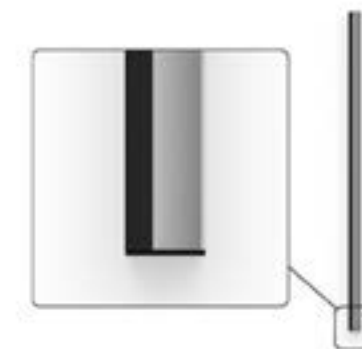

REF.	DIMENSION		FINISH	DIFFUSER	POWER	CRI	DOWNLIGHT *2 LUMEN				WATT		DIMM
	MM	MM					.27	.30	.40	.TW *1	K	TW	
210009	.01	307	●	.TP	.ST	.9	765	795	825	1900-1970	6	13	.DA .PU .D1
	.02	447					1148	1193	1238	2850-2955	9	20	
	.03	588					1530	1590	1650	3800-3940	12	26	

REF.	DIMENSION		FINISH	DIFFUSER	POWER	CRI	DOWNLIGHT *2 LUMEN			WATT		DIMM
	MM	MM					.27	.30	.40	K	TW	
210009	.01	307	●	.TP	.HI	.9	1530	1589	1652	12		.DA .PU .D1
	.02	447					2295	2384	2478	18		
	.03	588					3060	3178	3304	24		

Reference order | 210009.XX.WS.XX.XX.XX.9.XX.XX

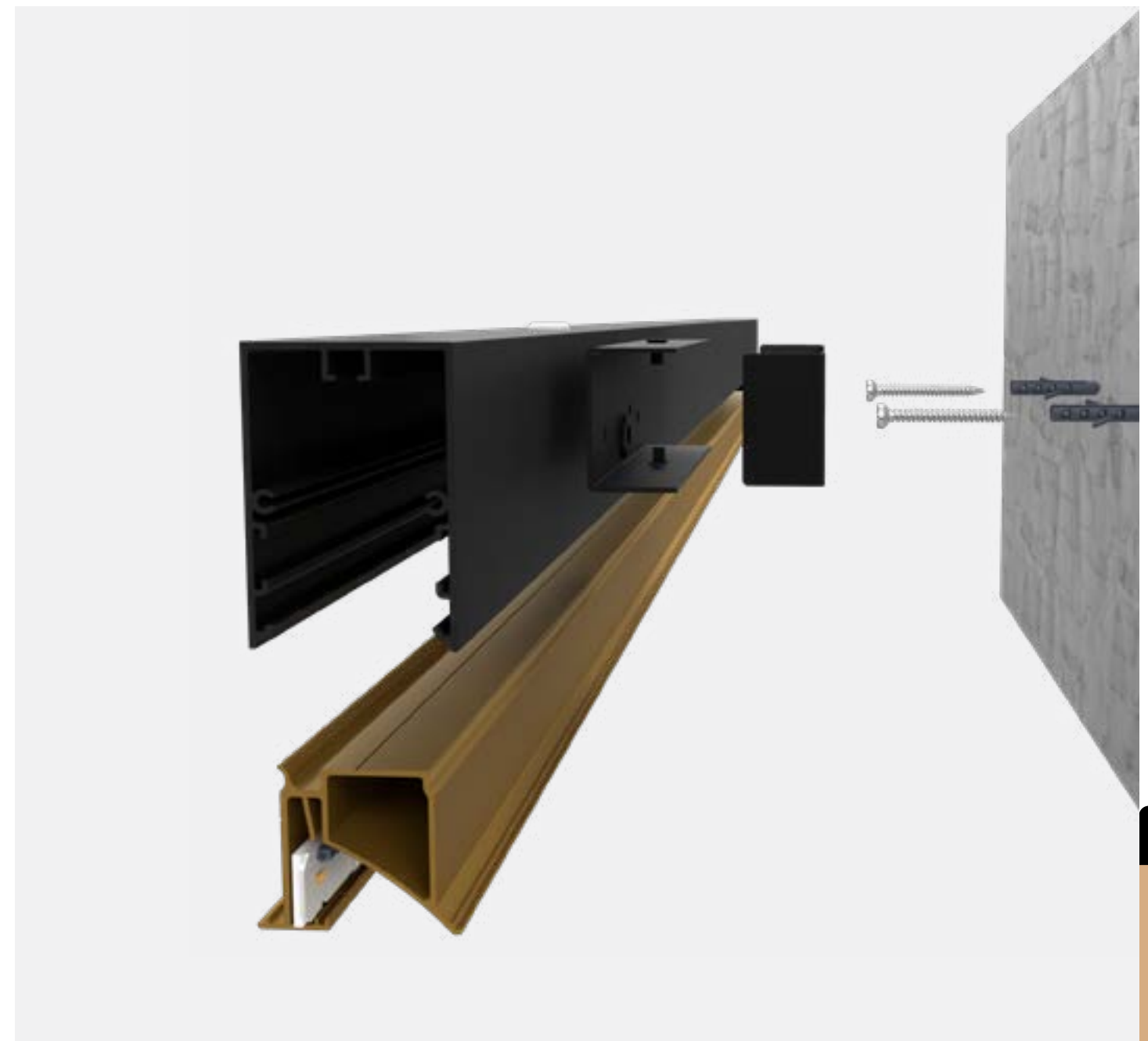

WALL SURFACE

Select finish



ALBA ASIMETRIC

REF 210009.WS

PHOTOMETRY



TRANSPARENT PC

INCLUDED



COVER KIT

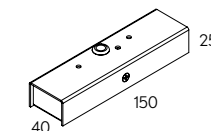

WALL SURFACE MOUNTING KIT

PROFILE

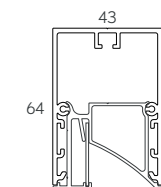

*1 Tunable White (TW) values correspond to 2700K and 6500K - TW is only available for DALI DT8 dimmable (.DA), CRI 80 (8) 700mA. Los valores del blanco dinámico (TW) corresponden a 2700K y 6500K. -TW solo está disponible con protocolo DALI DT8 (.DA), CRI 80 (8) 700mA.
*2 Down light (direct light) works at 500mA. La luz directa trabaja a 500mA.



FINISHES

● COLORS



DIMENSIONS

◆ ELECTRIC SYSTEM LENGTH mm.

307 | 447 | 588

LIGHTING OPTIONS

■ DIFFUSERS

OPAL | MICROPRISMATIC

POWER

STANDARD | HIGH

CRI

90

COLOR TEMPERATURE

2700K | 3000K | 4000K

▼ DIMMABLE OPTIONS

DALI | 1.10 | PUSH

▲ LIGHT DISTRIBUTION

UP

LUMINAIRE INCLUDES

Wall surface mounting kit
Cover Kit



ON DEMAND

Special RAL Color
Emergency Lighting *
Motion Detection
Well-Certified LED Boards
Special Color Temperature
RGB
Thematic LED
Wireless Control Options (Casambi)
CRI 80

* Delivered separately
(not installed in luminaire).

.WS

WALL SURFACE

INSTALLATIONS

.PN
PENDANT

10169 ALZIRA | PN
Pag. 266

.WS
WALL SURFACE

10169 ALZIRA | WS
Pag. 798



ALZIRA

REF 10169.WS

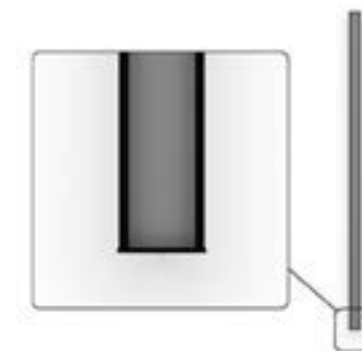

REF.	DIMENSION		FINISH	DIFFUSER	POWER	CRI	DOWNLIGHT LUMEN			WATT	DIMM
	MM	MM					.27	.30	.40		
10169	.01	307	●	.OP .MP	.ST	.9	765	795	825	6	.DA .PU .D1
	.02	447					1148	1193	1238	9	
	.03	588					1530	1590	1650	12	

REF.	DIMENSION		FINISH	DIFFUSER	POWER	CRI	DOWNLIGHT LUMEN			WATT	DIMM
	MM	MM					.27	.30	.40		
10169	.01	307	●	.OP .MP	.HI	.9	1530	1589	1652	12	.DA .PU .D1
	.02	447					2295	2384	2478	18	
	.03	588					3060	3178	3304	24	

Reference order | 10169.XX.WS.XX.XX.XX.9.XX.XX

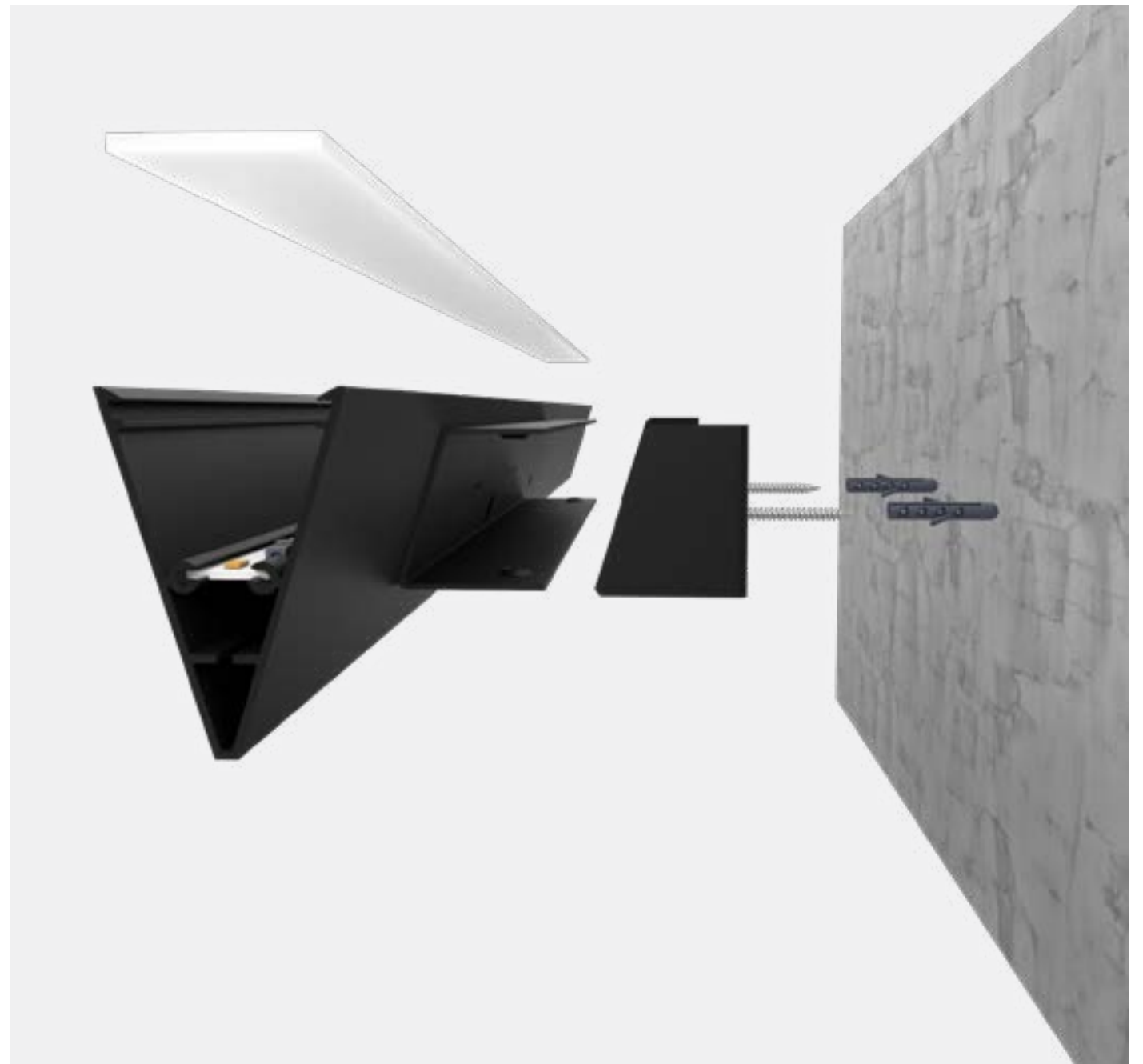

WALL SURFACE

Select finish



.WH-WH .BK-BK .GC-GC .BM-BM .BS-BS .BC-BC .CR-CR .CB-CB .GY-GY .MG-MG .VC-VC .YM-YM



ALZIRA

REF 10169.WS

PHOTOMETRY

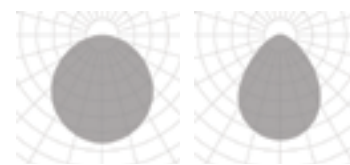

OPAL MICROPRISMATIC

INCLUDED

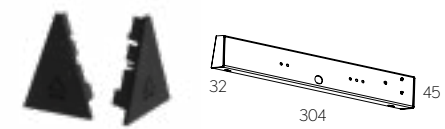

COVER KIT WALL SURFACE MOUNTING KIT

PROFILE

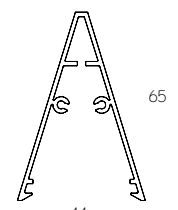

44

new

FINISHES

● ACOUSTIC COLORS



● PROFILE COLORS



DIMENSIONS

● LENGTHS mm.

1200

LIGHTING OPTIONS

■ DIFFUSERS

OPAL

MICROPRISMATIC

POWER

STANDARD

CRI

90

COLOR TEMPERATURE

2700K | 3000K | 4000K

▼ DIMMABLE OPTIONS

DALI

1.10

PUSH

▲ LIGHT DISTRIBUTION

Up

LUMINAIRE INCLUDES

Wall surface mounting kit
Cover Kit

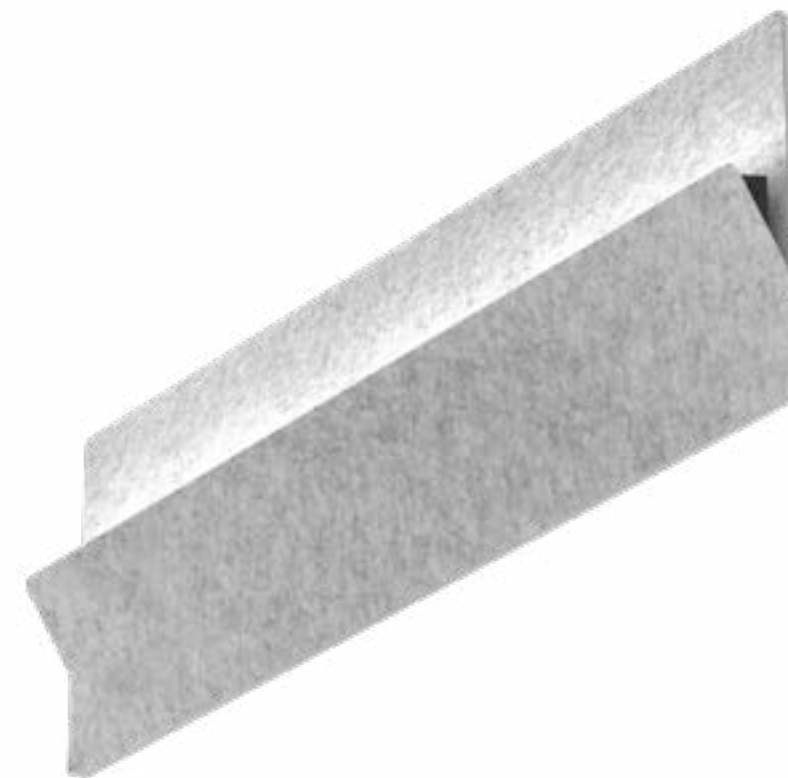

ON DEMAND

Emergency Lighting*
Motion Detection
Well-Certified LED Boards
Special Color Temperature
RGB
Thematic LED
Wireless Control Options (Casambi)
CRI 80

* Delivered separately
(not installed in luminaire).

WS

WALL SURFACE



ACOUSTIC ALZIRA WS

Designed by Rafa Ortega

REF 230002.WS



Designed by Rafa Ortega, this model belongs to Papyrus collection, a selection of luminaires that give shape and style to your decorative schemes while providing sustainable sound insulation in the room.

Diseñado por Rafa Ortega, este modelo pertenece a la colección Papyrus, una colección que da forma y estilo a tus esquemas decorativos a la vez que proporciona un aislamiento acústico sostenible en la estancia.



REF.	DIMENSION ♦	FINISH ●		DIFFUSER ■	POWER	CRI	DOWNLIGHT * LUMEN			WATT K	DIMM ▼
		.27	.30				.40				
230002	.01 1200mm	.50 .51	WH BK	.OP .MP	.ST	.9	3060	3180	3300	24	.DA .PU .D1

Reference order | 230002.01.WS.XX.XX.XX.XX.9.XX.XX

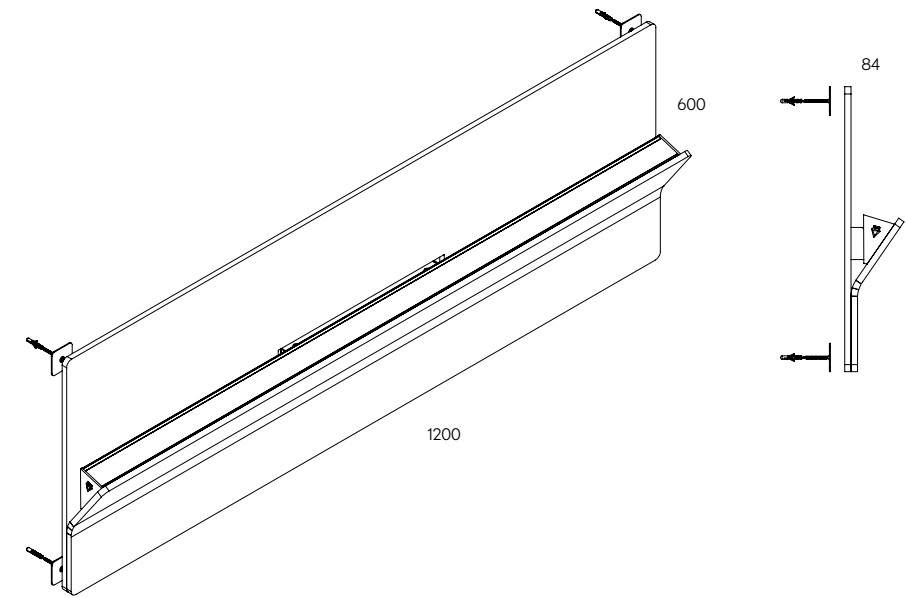

● Select Acoustic finishes

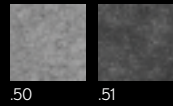

● Select Profile finishes

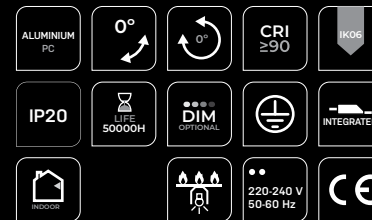
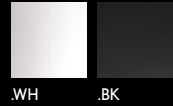

ACOUSTIC ALZIRA WS

Designed by Rafa Ortega
REF 230002.WS

WS
WALL SURFACE

ACOUSTIC PROPERTIES

- ENVIRONMENTAL:**
- FIRE TEST:**
- BAFFLE THICKNESS:**
- BABBLE DENSITY:**
- SOUND ABSORPTION COEFFICIENT:**

Comply with the requirements detailed in the BREEAM International, BREEAM-NOR v6.0 and LEED v4.1 Standards
Classification B-s1, d0 and CTEDB-SI Compliant
12mm
190 Kg/m³
0,92 α_w

PHOTOMETRY

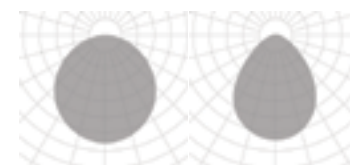

OPAL MICROPRISMATIC

INCLUDED



COVERT KIT

PROFILE

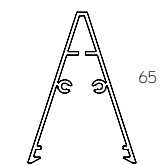

47



FINISHES

● ACOUSTIC COLORS



DIMENSIONS

● SIZES mm.

Ø800	Ø1000	Ø1200
800x800	1000x1000	1200x1200

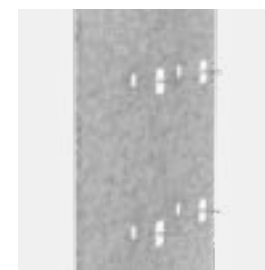
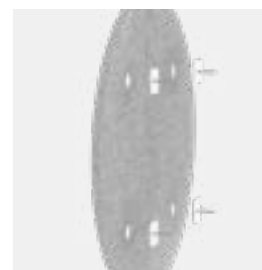
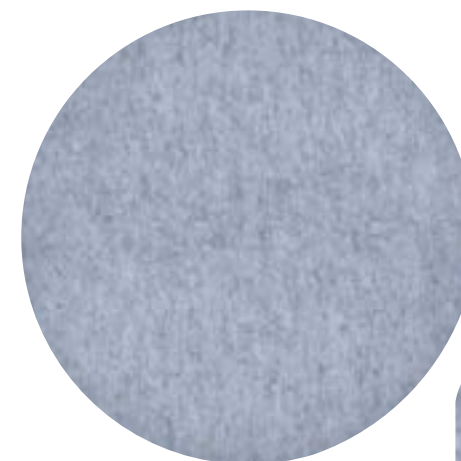

.WS

.WS

RD PANEL	REF.	DIMENSION	FINISH	SKETCH
	AC.RD	.01	●	
		.02		
		.03		

SQ PANEL	REF.	DIMENSION	FINISH	SKETCH
	AC.SQ	.01	●	
		.02		
		.03		

Reference order AC.RD.XX.WS.XX

Reference order AC.SQ.XX.WS.XX

ACOUSTIC ACCESORIES RD | SQ PANEL

REF AC.RD | AC.SQ

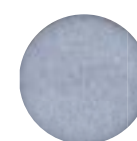

Ø800mm

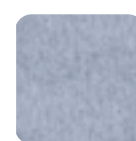

800x800mm



Ø1000mm

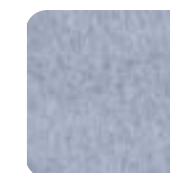

1000x1000mm



Ø1200mm



1200x1200mm

WALL SURFACE

new

FINISHES

● COLORS



DIMENSIONS

◆ DIAMETERS mm.

300x1200 | 600x1200

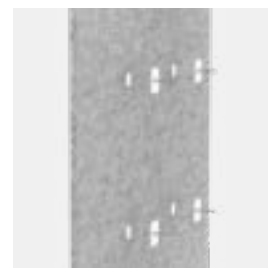

.WS



FL PANEL	REF.	DIMENSION	FINISH	SKETCH
	AC.FL	.01	●	
		.02		

Reference order | AC.FL.XX.WS.XX



ACOUSTIC ACCESORIES FL PANEL

REF AC.FL



300 x 1200mm



600 x 1200mm

.WS

WALL SURFACE

WALL METIS	REF.	DIMENSIONS	FINISHES	LAMP	OPTIC OPTIONS	POWER	CRI	K	LUMEN	WATT	mA	DIMM	SKETCH				
	10098	.01	.WH-WH	GU5.3		GU5.3	.9	.27 .30 .40 .27 .30 .40	526	Max 8	-	-					
				GU10	.GU	GU10			570								
				LED	.40 .60	.ST BPM50			8	350							
										.HI BPM300				711	10	500	.DA .PU .D1
														707			
														927			
767																	

LUMINAIRE INCLUDES

With opal optic cover.
Con difusor opal.

Wall surface mounting kit

Reference order

10098.01.WS.WH-WH.XX.XX.XX.XX



FINISHES



DIMENSIONS

.01

LIGHTING OPTIONS

BEAM ANGLE / LAMP

40° | 60° | GU5.3 | GU10

POWER

STANDARD

CRI

90

COLOR TEMPERATURE

2700K | 3000K | 4000K

DIMMABLE OPTIONS

DALI | 1.10 | PUSH

LIGHT DISTRIBUTION

UP



CRISMOSIL

WS

WALL SURFACE



WALL METIS

REF 10098.WS

PHOTOMETRY

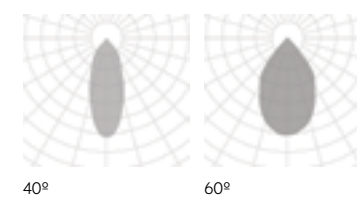

40°

60°

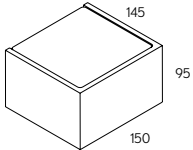
WALL ELARA	REF.	DIMENSIONS	FINISHES	LAMP	DIFFUSER	POWER	CRI	K	LUMEN	WATT	mA	DIMM	SKETCH
	10097	.01	.WH-WH	LED	.OP	.ST	.9	.27	837	8	350	.DA .PU .D1	
						.30		930					
						.40		1020					
						.27		1745	16	700			
						.30		1938					
						.40		2077					

LUMINAIRE INCLUDES

With opal optic cover.
Con difusor opal.

Wall surface mounting kit

Reference order  10097.01.WS.WH-WH.XX.XX.9.XX.XX



FINISHES



DIMENSIONS

.01

LIGHTING OPTIONS

DIFFUSER

OPAL

POWER

STANDARD

CRI

90

COLOR TEMPERATURE

2700K | 3000K | 4000K

DIMMABLE OPTIONS

DALI | 1.10 | PUSH

LIGHT DISTRIBUTION

UP



CRISMOSIL

WALL SURFACE

- CRISMOSIL
- 0°
- 0°
- CRI ≥ 90
- IP20
- LIFE 50000H
- DIM OPTIONAL
- INTEGRATED
- 220-240 V 50-60 Hz
- CE

WALL ELARA

REF 10097.WS

WALL TEBE	REF.	DIMENSIONS	FINISHES	LAMP	DIFFUSER	POWER	CRI	K	LUMEN	WATT	mA	DIMM	SKETCH
	10096	.01	.WH-WH	LED	.OP	.ST	.9	.27	387	3	500	.DA .PU .D1	
								.30	430				
								.40	450				
						.HI		.27	783	6	500		
								.30	870				
								.40	910				

WALL TEBE	REF.	DIMENSIONS	FINISHES	LAMP	DIFFUSER	POWER	CRI	K	LUMEN	WATT	mA	DIMM	SKETCH
	10096	.02	.WH-WH	LED	.OP	.ST	.9	.27	387	3	500	.DA .PU .D1	
								.30	430				
								.40	450				
						.HI		.27	783	6	500		
								.30	870				
								.40	910				

WALL TEBE	REF.	DIMENSIONS	FINISHES	LAMP	DIFFUSER	POWER	CRI	K	LUMEN	WATT	mA	DIMM	SKETCH
	10096	.03	.WH-WH	LED	.OP	.ST	.9	.27	820	6	500	.DA .PU .D1	
								.30	870				
								.40	910				
						.HI		.27	1640	12	500		
								.30	1730				
								.40	1817				

FINISHES



DIMENSIONS

.01 | .02 | .03

LIGHTING OPTIONS

DIFFUSER

OPAL

POWER

STANDARD | HIGH

CRI

90

COLOR TEMPERATURE

2700K | 3000K | 4000K

DIMMABLE OPTIONS

DALI | 1.10 | PUSH

LIGHT DISTRIBUTION

UP



LUMINAIRE INCLUDES

Con difusor opal. / *2700K sólo disponible en 10094.
With opal optic cover. / *2700K only available in 10094.

Wall surface mounting kit

Reference order

10096.XX.WS.WH-WH.XX.XX.9.XX.XX

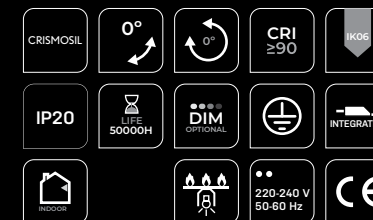

WALL TEBE

REF 10096.WS

WALL SURFACE

WALL LEDA	REF.	DIMENSIONS	FINISHES	LAMP	DIFFUSER	POWER	CRI	K	LUMEN	WATT	mA	DIMM	SKETCH
	10051	.01	.WH-WH	LED	.OP	.ST	.9	.27	820	6	500	.DA .PU .D1	
								.30	870				
								.40	910				
						.HI		.27	1640	12	500		
								.30	1730				
								.40	1817				

WALL LEDA	REF.	DIMENSIONS	FINISHES	LAMP	DIFFUSER	POWER	CRI	K	LUMEN	WATT	mA	DIMM	SKETCH
	10051	.02	.WH-WH	LED	.OP	.ST	.9	.27	1640	12	500	.DA .PU .D1	
								.30	1740				
								.40	1820				
						.HI		.27	3280	24	500		
								.30	3460				
								.40	3634				

WALL LEDA	REF.	DIMENSIONS	FINISHES	LAMP	DIFFUSER	POWER	CRI	K	LUMEN	WATT	mA	DIMM	SKETCH
	10051	.03	.WH-WH	LED	.OP	.ST	.9	.27	2460	18	500	.DA .PU .D1	
								.30	2610				
								.40	2730				
						.HI		.27	4920	36	500		
								.30	5190				
								.40	5452				

FINISHES



DIMENSIONS

.01 | .02 | .03

LIGHTING OPTIONS

DIFFUSER

OPAL

POWER

STANDARD | HIGH

CRI

90

COLOR TEMPERATURE

2700K | 3000K | 4000K

DIMMABLE OPTIONS

DALI | 1.10 | PUSH

LIGHT DISTRIBUTION

UP



LUMINAIRE INCLUDES

Wall surface mounting kit

Reference order

10051.XX.WS.WH-WH.XX.XX.9.XX.XX

Con difusor opal.
With opal optic cover.



WALL LEDA

REF 10051.WS

WALL SURFACE

.WS

WALL ARCE	REF.	DIMENSIONS	FINISHES	LAMP	DIFFUSER	POWER	CRI	K	LUMEN	WATT	mA	DIMM	SKETCH
	10055	.01	.WH-WH	LED	.OP	.ST	.9	.27	820	6	500	.DA .PU .D1	
								.30	870				
								.40	910				
						.HI		.27	1640	12	500		
								.30	1730				
								.40	1817				

WALL ARCE	REF.	DIMENSIONS	FINISHES	LAMP	DIFFUSER	POWER	CRI	K	LUMEN	WATT	mA	DIMM	SKETCH
	10055	.02	.WH-WH	LED	.OP	.ST	.9	.27	1640	12	500	.DA .PU .D1	
								.30	1740				
								.40	1820				
						.HI		.27	3280	24	500		
								.30	3460				
								.40	3634				

WALL ARCE	REF.	DIMENSIONS	FINISHES	LAMP	DIFFUSER	POWER	CRI	K	LUMEN	WATT	mA	DIMM	SKETCH
	10055	.03	.WH-WH	LED	.OP	.ST	.9	.27	2460	18	500	.DA .PU .D1	
								.30	2610				
								.40	2730				
						.HI		.27	4920	36	500		
								.30	5190				
								.40	5452				

FINISHES



DIMENSIONS

.01 | .02 | .03

LIGHTING OPTIONS

DIFFUSER

OPAL

POWER

STANDARD | HIGH

CRI

90

COLOR TEMPERATURE

2700K | 3000K | 4000K

DIMMABLE OPTIONS

DALI | 1.10 | PUSH

LIGHT DISTRIBUTION

UP



LUMINAIRE INCLUDES

Wall surface mounting kit

Reference order

10055.XX.WS.WH-WH.XX.XX.9.XX.XX

Con difusor opal.
With opal optic cover.





WALL ARCE

REF 10055.WS

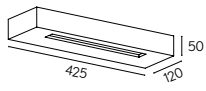
WALL SURFACE

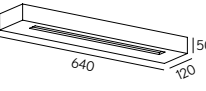
WALL CARPO	REF.	DIMENSIONS	FINISHES	LAMP	DIFFUSER	POWER	CRI	K	LUMEN	WATT	mA	DIMM	SKETCH
	10059	.01	.WH-WH	LED	.OP	.ST	.9	.27	2x820	6+6	500	.DA .PU .D1	
								.30	2x870				
								.40	2x910				
						.HI		.27	2x1640	12+12	500		
								.30	2x1730				
								.40	2x1817				

WALL CARPO	REF.	DIMENSIONS	FINISHES	LAMP	DIFFUSER	POWER	CRI	K	LUMEN	WATT	mA	DIMM	SKETCH
	10059	.02	.WH-WH	LED	.OP	.ST	.9	.27	2x1640	12+12	500	.DA .PU .D1	
								.30	2x1740				
								.40	2x1820				
						.HI		.27	2x3280	24+24	500		
								.30	2x3460				
								.40	2x3634				

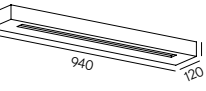
WALL CARPO	REF.	DIMENSIONS	FINISHES	LAMP	DIFFUSER	POWER	CRI	K	LUMEN	WATT	mA	DIMM	SKETCH
	10059	.03	.WH-WH	LED	.OP	.ST	.9	.27	2x2460	18+18	500	.DA .PU .D1	
								.30	2x2610				
								.40	2x2730				
						.HI		.27	2x4920	36+36	500		
								.30	2x5190				
								.40	2x5452				

FINISHES



DIMENSIONS

.01 | .02 | .03

LIGHTING OPTIONS

DIFFUSER

OPAL

POWER

STANDARD | HIGH

CRI

90

COLOR TEMPERATURE

2700K | 3000K | 4000K

DIMMABLE OPTIONS

DALI | 1.10 | PUSH

LIGHT DISTRIBUTION

UP-DOWN



LUMINAIRE INCLUDES

Wall surface mounting kit

Reference order

10059.XX.WS.WH-WH.XX.XX.9.XX.XX

Con difusor opal.
With opal optic cover.



WALL CARPO

REF 10059.WS

WALL SURFACE

WALL RECESSED

VISUAL INDEX

WALLLIGHTS

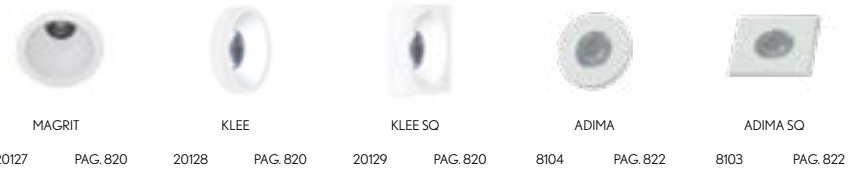

FLOOR WASHER

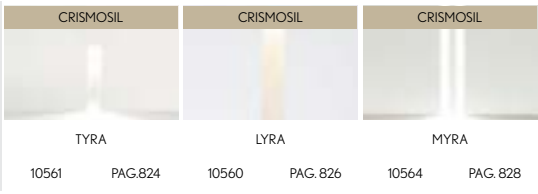

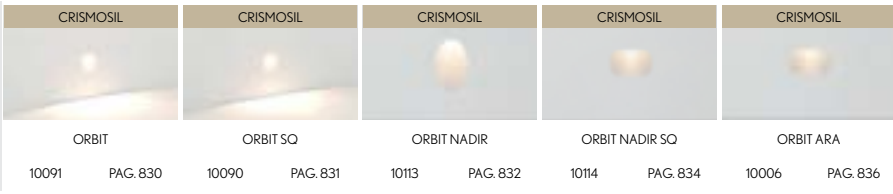

ORBIT



DRACO

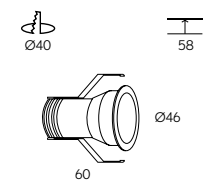

MAGRIT	REF.	DIMENSION	FINISH	OPTIC OPTIONS	POWER	CRI	K	LUMEN	WATT	mA	DIMM	SKETCH
	20127	.01	●	.25	.ST	.9	.30	118	2.5	700	-	

Reference order |  20127.01.WR.XX.25.ST.9.30

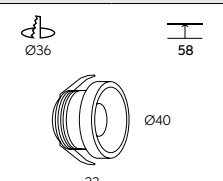
KLEE	REF.	DIMENSION	FINISH	OPTIC OPTIONS	POWER	CRI	K	LUMEN	WATT	mA	DIMM	SKETCH
	20128	.01	●	.25	.ST	.9	.30	118	2.5	700	-	

Reference order |  20128.01.WR.XX.25.ST.9.30

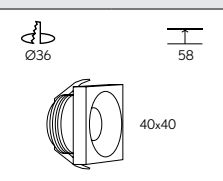
KLEE SQ	REF.	DIMENSION	FINISH	OPTIC OPTIONS	POWER	CRI	K	LUMEN	WATT	mA	DIMM	SKETCH
	20129	.01	●	.25	.ST	.9	.30	118	2.5	700	-	

Reference order |  20129.01.WR.XX.25.ST.9.30

FINISHES

COLORS



DIMENSIONS

View in family specifications

.01

LIGHTING OPTIONS

BEAM ANGLE

25°

POWER

STANDARD

CRI

90

COLOR TEMPERATURE

3000K

DIMMABLE OPTIONS

-

LIGHT DISTRIBUTION

SIDE



WALL RECESSED

Select external-internal finishes

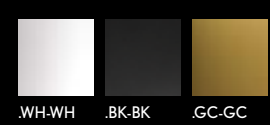

- ALUMINIUM PC
- 0°
- 0°
- CRI ≥90
- IK05
- IP20
- IP23
- LIFE 50000H
- DIM OPTIONAL
- INTEGRATED
- INDOOR
- 220-240 V 50-60 Hz
- CE

MAGRIT | KLEE | SQ

REF 20127.WR | 20128.WR | 20129.WR

PHOTOMETRY

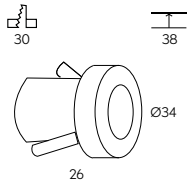

25°

ADIMA	REF.	DIMENSION	FINISH	OPTIC OPTIONS	POWER	CRI	K	LUMEN	WATT	mA	DIMM	SKETCH
	8104	.01	●	■	.ST	.9	.30	154	3	700	-	

Reference order  8104.01.WR.XX.25.ST.9.30

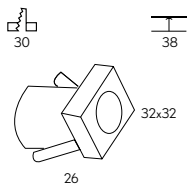
ADIMA SQ	REF.	DIMENSION	FINISH	OPTIC OPTIONS	POWER	CRI	K	LUMEN	WATT	mA	DIMM	SKETCH
	8103	.01	●	■	.ST	.9	.30	154	3	700	-	

Reference order  8103.01.WR.XX.25.ST.9.30

FINISHES

COLORS



DIMENSIONS

View in family specifications

.01

LIGHTING OPTIONS

BEAM ANGLE

25°

POWER

STANDARD

CRI

90

COLOR TEMPERATURE

3000K

DIMMABLE OPTIONS

-

LIGHT DISTRIBUTION

SIDE

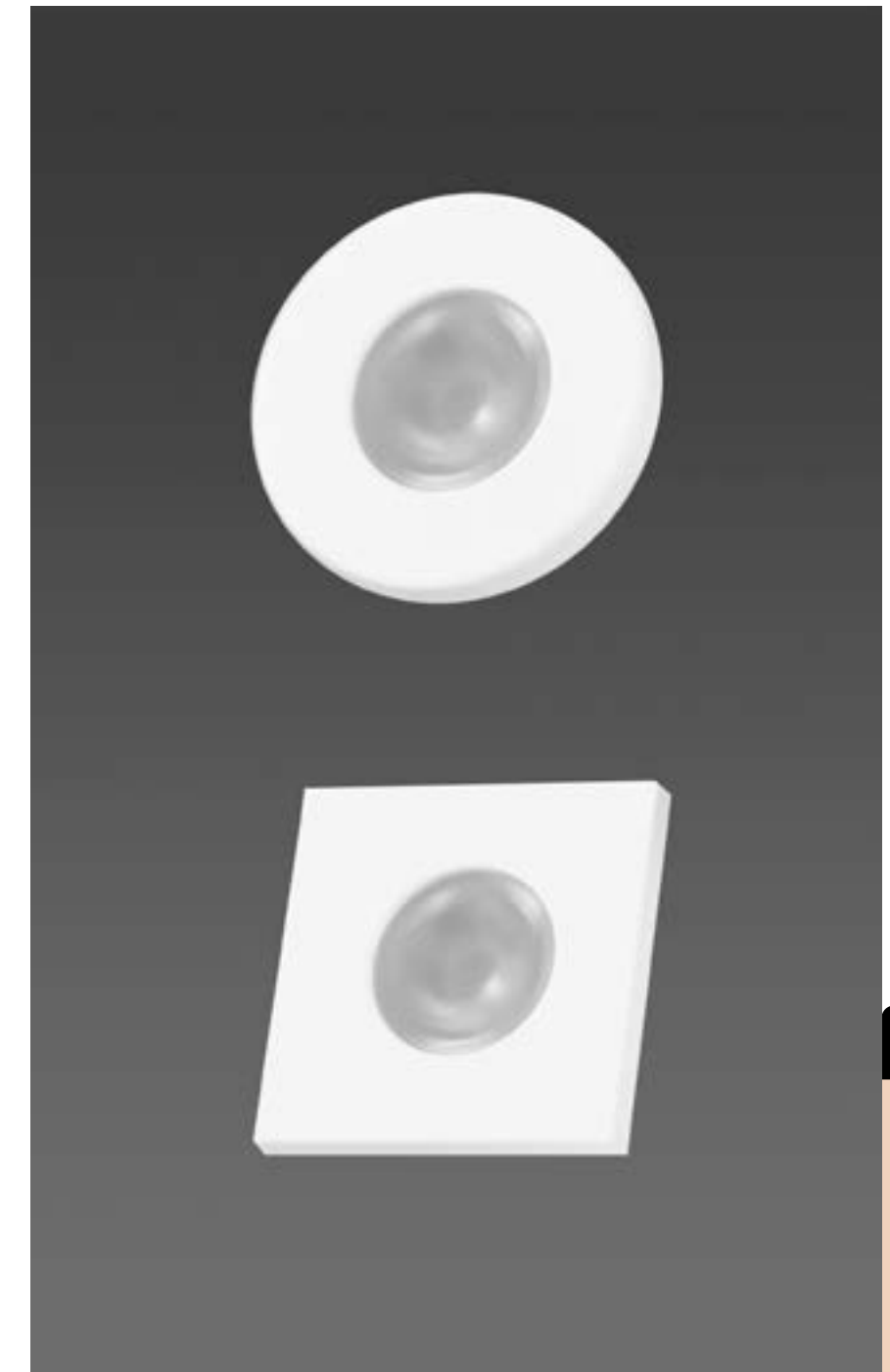

WALL RECESSED

Select finishes

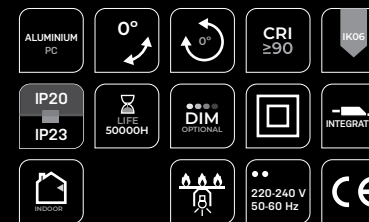
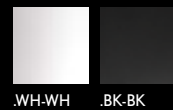





ADIMA ADIMA SQ

REF 8104.WR | 8103.WR

PHOTOMETRY

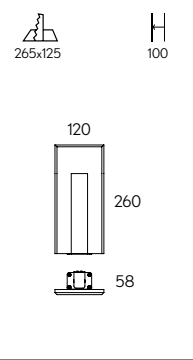

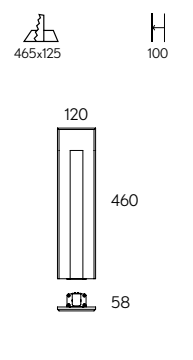
25°

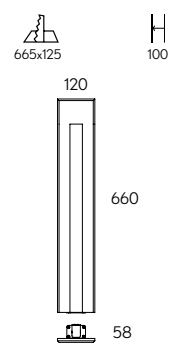
TYRA	REF.	DIMENSIONS	FINISHES	LAMP	OPTIC OPTIONS	POWER	CRI	K	LUMEN	WATT	mA	DIMM *1	SKETCH
	10561	.01	.WH-WH	LED	.25	.ST	.9	.27 .30 .40	237 246 261	3	700	.DA .PU .D1	
	10561	.02	.WH-WH	LED	.25	.ST	.9	.27 .30 .40	237 246 261	3	700	.DA .PU .D1	
	10561	.03	.WH-WH	LED	.25	.ST	.9	.27 .30 .40	237 246 261	3	700	.DA .PU .D1	

FINISHES



DIMENSIONS

.01 | .02 | .03

LIGHTING OPTIONS

BEAM ANGLE

25°

POWER

STANDARD

CRI

90

COLOR TEMPERATURE

2700K | 3000K | 4000K

DIMMABLE OPTIONS

DALI | 1.10 | PUSH

LIGHT DISTRIBUTION

DOWN



.WR
WALL RECESSED

LUMINAIRE INCLUDES

Con difusor opal.
With opal optic cover.

Recessed mounting kit

Reference order

10561.XX.WR.WH-WH.25.ST9.XX.XX

*1 Remote driver when dimmable. Driver remoto cuando es dimable.

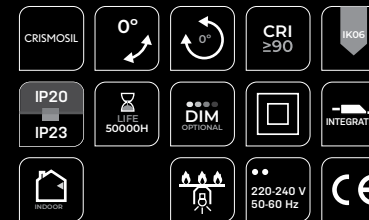

TYRA

REF 10561.WR

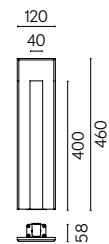
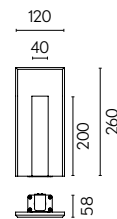

LYRA	REF.	DIMENSIONS	FINISHES	LAMP	DIFFUSER	POWER	CRI	K	LUMEN	WATT	mA	DIMM	SKETCH
	10560	.01	.WH-WH	LED	.OP	.ST	.9	.27	680	7	350	.DA .PU .D1	
								.30	750				
								.40	780				
						.HI		.27	713	10	500		
								.30	750				
								.40	825				
	10560	.02	.WH-WH	LED	.OP	.ST	.9	.27	680	7	350	.DA .PU .D1	
								.30	750				
								.40	780				
						.HI		.27	713	10	500		
								.30	750				
								.40	825				
	10560	.03	.WH-WH	LED	.OP	.ST	.9	.27	680	7	350	.DA .PU .D1	
								.30	750				
								.40	780				
						.HI		.27	713	10	500		
								.30	750				
								.40	825				

FINISHES



DIMENSIONS

.01 | .02 | .03

LIGHTING OPTIONS

DIFFUSER

OPAL

POWER

STANDARD | HI

CRI

90

COLOR TEMPERATURE

2700K | 3000K | 4000K

DIMMABLE OPTIONS

DALI | 1.10 | PUSH

LIGHT DISTRIBUTION

DOWN



CRISMOSIL

.WR

WALL RECESSED

LUMINAIRE INCLUDES

Con difusor opal.
With opal optic cover.

Recessed mounting kit

Reference order



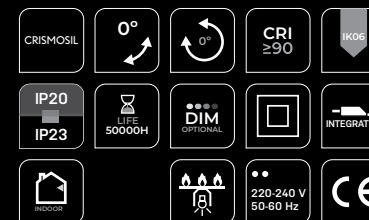





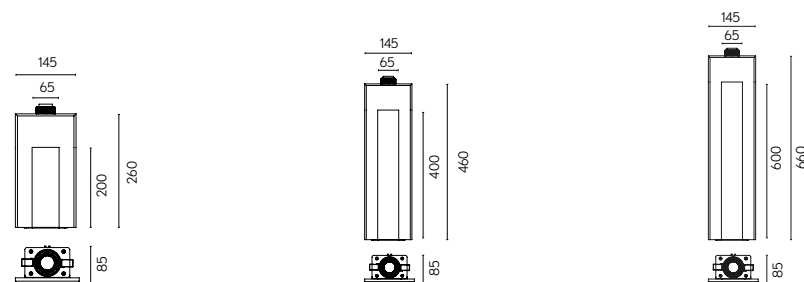

10560.XX.WR.WH-WH.OP.XX.9.XX.XX

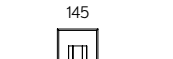
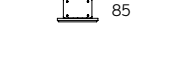

LYRA

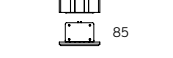
REF 10560.WR



MYRA	REF.	DIMENSIONS	FINISHES	LAMP	DIFFUSER	POWER	CRI	K	LUMEN	WATT	VdC	DIMM	SKETCH	
	10564	.01	.WH-WH	LED	.OP	.ST	.9	.27	188	3	24	.DA .PU .D1		
								.30	195					
								.40	248					
						.HI		.27	403	6	24		.30	417
								.30	417					
								.40	530					
	10564	.02	.WH-WH	LED	.OP	.ST	.9	.27	376	6	24	.DA .PU .D1		
								.30	390					
								.40	495					
						.HI		.27	806	12	24		.30	834
								.30	834					
								.40	1061					
	10564	.03	.WH-WH	LED	.OP	.ST	.9	.27	500	9	24	.DA .PU .D1		
								.30	584					
								.40	743					
						.HI		.27	1210	18	24		.30	1252
								.30	1252					
								.40	1591					

FINISHES



DIMENSIONS

.01 | .02 | .03

LIGHTING OPTIONS

DIFFUSER

OPAL

POWER

STANDARD | HI

CRI

90

COLOR TEMPERATURE

2700K | 3000K | 4000K

DIMMABLE OPTIONS

DALI | 1.10 | PUSH

LIGHT DISTRIBUTION

DOWN



.WR

WALL RECESSED

LUMINAIRE INCLUDES

Con difusor opal.
With opal optic cover.

Recessed mounting kit

Reference order

10564.XX.WR.WH-WH.OP.XX.9.XX.XX

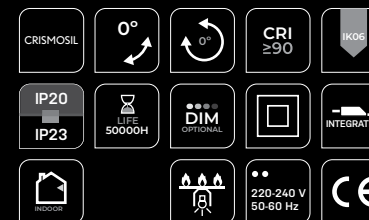
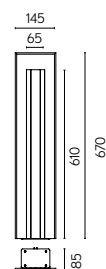
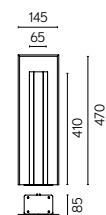
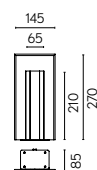

MYRA

REF 10564.WR

• FINISHES



• DIMENSIONS

.01

LIGHTING OPTIONS

■ DIFFUSER

OPAL

POWER

STANDARD

CRI

90

COLOR TEMPERATURE

2700K | 3000K | 4000K

▼ DIMMABLE OPTIONS

DALI | 1.10 | PUSH

▲ LIGHT DISTRIBUTION

DOWN



ORBIT	REF.	DIMENSIONS	FINISHES	LAMP	DIFFUSER	POWER	CRI	K	LUMEN	WATT	mA	DIMM *1	SKETCH
	10091	.01	.WH-WH	LED	.OP	.ST	.9	.27	295	3	350	.DA .PU .D1	
								.30	305				
								.40	320				

Con difusor opal.
With opal optic cover.

LUMINAIRE INCLUDES

Recessed mounting kit

Reference order

10091.01.WR.WH-WH.OP.ST.9.XX.XX

*1 Remote driver when dimmable. Driver remoto cuando es dimable.



ORBIT

REF 10091.WR

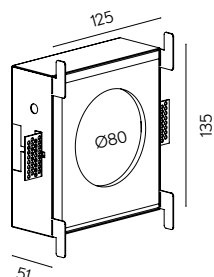

• FINISHES



• DIMENSIONS

.01

LIGHTING OPTIONS

■ DIFFUSER

OPAL

POWER

STANDARD

CRI

90

COLOR TEMPERATURE

2700K | 3000K | 4000K

▼ DIMMABLE OPTIONS

DALI | 1.10 | PUSH

▲ LIGHT DISTRIBUTION

DOWN



ORBIT SQ	REF.	DIMENSIONS	FINISHES	LAMP	DIFFUSER	POWER	CRI	K	LUMEN	WATT	mA	DIMM *1	SKETCH
	10090	.01	.WH-WH	LED	.OP	.ST	.9	.27	295	3	350	.DA .PU .D1	
								.30	305				
								.40	320				

Con difusor opal.
With opal optic cover.

LUMINAIRE INCLUDES

Recessed mounting kit

Reference order

10090.01.WR.WH-WH.OP.ST.9.XX.XX

*1 Remote driver when dimmable. Driver remoto cuando es dimable.



ORBIT

SQ

REF 10090.WR

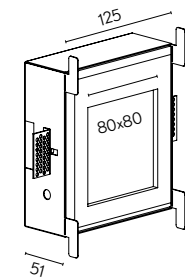

WALL RECESSED

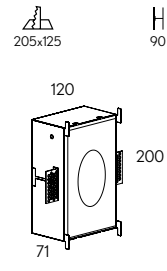
ORBIT NADIR	REF.	DIMENSIONS	FINISHES	LAMP	OPTIC OPTIONS	POWER	CRI	K	LUMEN	WATT	mA	DIMM *1	SKETCH
	10113	.01	.WH-WH	LED	.25	.ST	.9	.27	237	3	700	.DA .PU .D1	
								.30	246				
								.40	261				

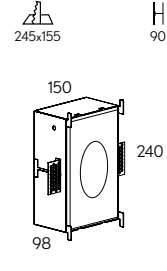
ORBIT NADIR	REF.	DIMENSIONS	FINISHES	LAMP	OPTIC OPTIONS	POWER	CRI	K	LUMEN	WATT	mA	DIMM *1	SKETCH
	10113	.02	.WH-WH	LED	.25	.ST	.9	.27	237	3	700	.DA .PU .D1	
								.30	246				
								.40	261				

LUMINAIRE INCLUDES

Recessed mounting kit

Reference order

10113.XX.WR.WH-WH.25.ST9.XX.XX

FINISHES



DIMENSIONS

.01 | .02

LIGHTING OPTIONS

BEAM ANGLE

25°

POWER

STANDARD

CRI

90

COLOR TEMPERATURE

2700K | 3000K | 4000K

DIMMABLE OPTIONS

DALI | 1.10 | PUSH

LIGHT DISTRIBUTION

DOWN



CRISMOSIL

.WR

WALL RECESSED

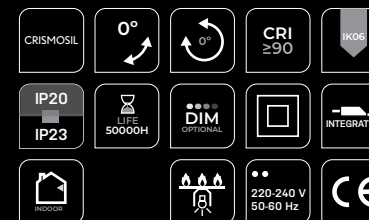

*1 Remote driver when dimmable. Driver remoto cuando es dimable.



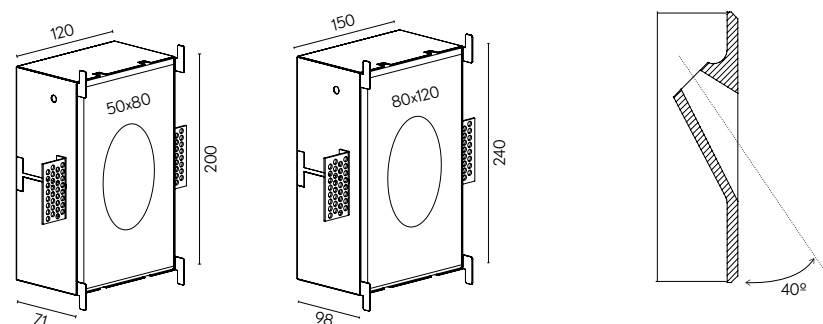

ORBIT NADIR

REF 10113.WR

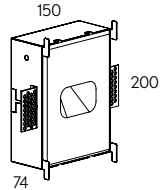

ORBIT NADIR SQ	REF.	DIMENSIONS	FINISHES	LAMP	OPTIC OPTIONS	POWER	CRI	K	LUMEN	WATT	mA	DIMM *1	SKETCH
	10114	.01	.WH-WH	LED	.25	.ST	.9	.27	237	3	700	.DA .PU .D1	
								.30	246				
								.40	261				

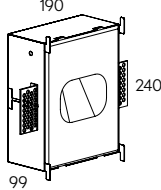
ORBIT NADIR SQ	REF.	DIMENSIONS	FINISHES	LAMP	OPTIC OPTIONS	POWER	CRI	K	LUMEN	WATT	mA	DIMM *1	SKETCH
	10114	.02	.WH-WH	LED	.25	.ST	.9	.27	237	3	700	.DA .PU .D1	
								.30	246				
								.40	261				

LUMINAIRE INCLUDES

Recessed mounting kit

Reference order | 10114.XX.WR.WH-WH.25.ST.9.XX.XX

FINISHES

□

DIMENSIONS

.01 | .02

LIGHTING OPTIONS

BEAM ANGLE

25°

POWER

STANDARD

CRI

90

COLOR TEMPERATURE

2700K | 3000K | 4000K

DIMMABLE OPTIONS

DALI | 1.10 | PUSH

LIGHT DISTRIBUTION

DOWN



WALL RECESSED

*1 Remote driver when dimmable. Driver remoto cuando es dimable.

- CRISMOSIL
- 0°
- 0°
- CRI ≥ 90
- IP20
- IP23
- LIFE 50000H
- DIM OPTIONAL
- INTEGRATED
- RECESSED
- 220-240 V 50-60 Hz
- CE

ORBIT NADIR SQ

REF 10114.WR

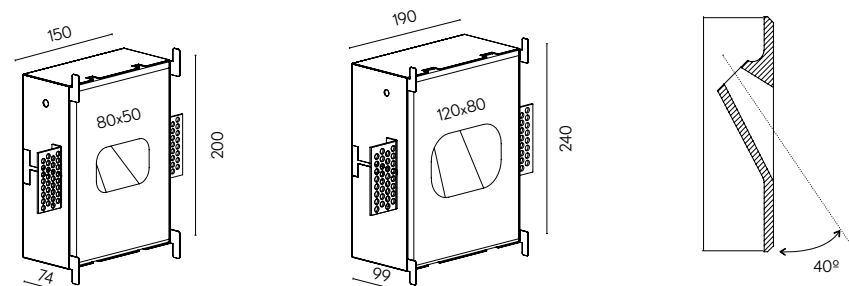

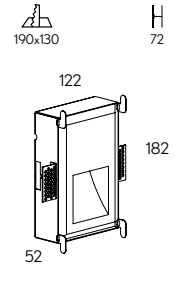
ORBIT ARA	REF.	DIMENSIONS	FINISHES	LAMP	OPTIC OPTIONS	POWER	CRI	K	LUMEN	WATT	mA	DIMM *1	SKETCH
	10006	.01	.WH-WH	LED	.25	.ST	.9	.27	237	3	700	.DA .PU .D1	
								.30	246				
								.40	261				

Con difusor opal.
With opal optic cover.

LUMINAIRE INCLUDES

Recessed mounting kit

Reference order

10006.01.WR.WH-WH.25.ST.9.XX.XX

*1 Remote driver when dimmable. Driver remoto cuando es dimable.



FINISHES



DIMENSIONS

.01

LIGHTING OPTIONS

BEAM ANGLE

25°

POWER

STANDARD

CRI

90

COLOR TEMPERATURE

2700K | 3000K | 4000K

DIMMABLE OPTIONS

DALI | 1.10 | PUSH

LIGHT DISTRIBUTION

DOWN



CRISMOSIL

.WR

WALL RECESSED



ORBIT ARA

REF 10006.WR

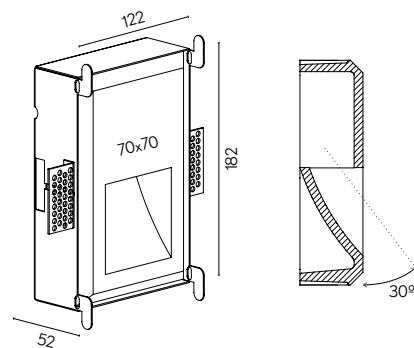

DRACO	REF.	DIMENSIONS	FINISHES	LAMP	OPTIC OPTIONS	POWER	CRI	K	LUMEN	WATT	mA	DIMM *1	SKETCH
	10119	.01	.WH-WH	LED	.25	.ST	.9	.27	237	3	700	.DA .PU .D1	
								.30	246				
								.40	261				

DRACO	REF.	DIMENSIONS	FINISHES	LAMP	OPTIC OPTIONS	POWER	CRI	K	LUMEN	WATT	mA	DIMM *1	SKETCH
	10119	.02	.WH-WH	LED	.25	.ST	.9	.27	237	3	700	.DA .PU .D1	
								.30	246				
								.40	261				

LUMINAIRE INCLUDES

Recessed mounting kit

Reference order | 10119.XX.WR.WH-WH.25.ST.9.XX.XX

Con difusor opal.
With opal optic cover.

FINISHES



DIMENSIONS

.01 | .02

LIGHTING OPTIONS

BEAM ANGLE

25°

POWER

STANDARD

CRI

90

COLOR TEMPERATURE

2700K | 3000K | 4000K

DIMMABLE OPTIONS

DALI | 1.10 | PUSH

LIGHT DISTRIBUTION

DOWN



CRISMOSIL

.WR

WALL RECESSED

*1 Remote driver when dimmable. Driver remoto cuando es dimable.

- CRISMOSIL
- 0°
- 0°
- CRI ≥90
- IP20
- IP23
- LIFE 50000H
- DIM OPTIONAL
- INTEGRATED
- RECESSED
- 220-240 V 50-60 Hz
- CE

DRACO

REF 10119.WR

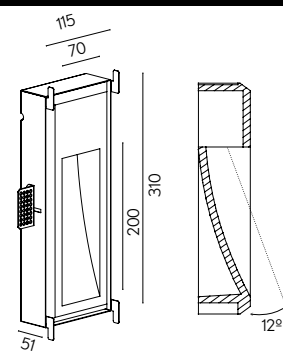
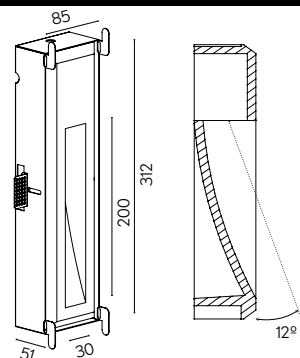

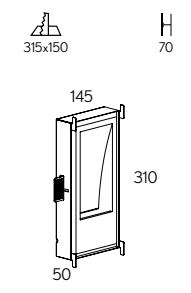
DRACO TUCANA	REF.	DIMENSIONS	FINISHES	LAMP	DIFFUSER	POWER	CRI	K	LUMEN	WATT	mA	DIMM *1	SKETCH
	10008	.01	.WH-WH	LED	.OP	.ST	.9	.27	387	3	500	.DA .PU .D1	
								.30	430				
								.40	450				
						.HI		.27	783	6	500		
								.30	870				
								.40	910				

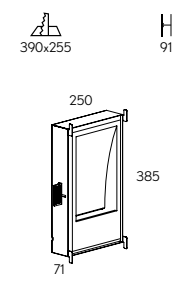
DRACO TUCANA	REF.	DIMENSIONS	FINISHES	LAMP	DIFFUSER	POWER	CRI	K	LUMEN	WATT	mA	DIMM *1	SKETCH
	10008	.02	.WH-WH	LED	.OP	.ST	.9	.27	387	3	500	.DA .PU .D1	
								.30	430				
								.40	450				
						.HI		.27	783	6	500		
								.30	870				
								.40	910				

LUMINAIRE INCLUDES

Con difusor opal.
With opal optic cover.

Recessed mounting kit

Reference order

10008.XX.WR.WH-WH.OP.XX.9.XX.XX

FINISHES



DIMENSIONS

.01 | .02

LIGHTING OPTIONS

DIFFUSER

OPAL

POWER

STANDARD | HI

CRI

90

COLOR TEMPERATURE

2700K | 3000K | 4000K

DIMMABLE OPTIONS

DALI | 1.10 | PUSH

LIGHT DISTRIBUTION

UP



*1 Remote driver when dimmable. Driver remoto cuando es dimable.

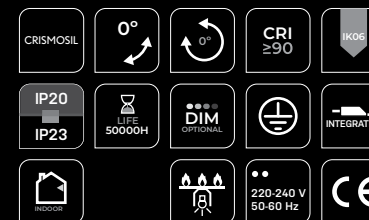

DRACO TUCANA

REF 10008.WR

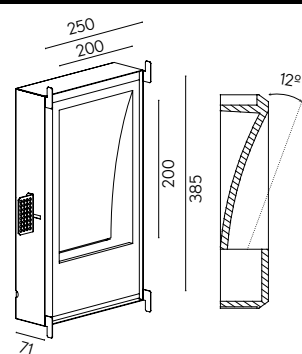
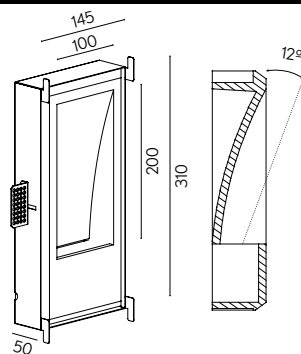

DRACO ZAHARA	REF.	DIMENSIONS	FINISHES	LAMP	DIFFUSER	POWER	CRI	K	LUMEN	WATT	mA	DIMM *1	SKETCH		
	10009	.01	.WH-WH	LED	.OP	.ST	.9	.30	430	3	500	.DA .PU .D1			
						.40		450							
						.HI		.30	870	6	500			.40	910

DRACO ZAHARA	REF.	DIMENSIONS	FINISHES	LAMP	DIFFUSER	POWER	CRI	K	LUMEN	WATT	mA	DIMM *1	SKETCH		
	10009	.02	.WH-WH	LED	.OP	.ST	.9	.27	387	3	500	.DA .PU .D1			
						.30		430							
						.40		450							
						.HI		.27	783	6	500			.30	870
						.40		910							

FINISHES



DIMENSIONS

.01 | .02

LIGHTING OPTIONS

DIFFUSER

OPAL

POWER

STANDARD | HI

CRI

90

COLOR TEMPERATURE

2700K | 3000K | 4000K

DIMMABLE OPTIONS

DALI | 1.10 | PUSH

LIGHT DISTRIBUTION

UP



WALL RECESSED

LUMINAIRE INCLUDES

Recessed mounting kit

Reference order

10009.XX.WR.WH-WH.OP.XX.9.XX.XX

Con difusor opal.
With opal optic cover.

*1 Remote driver when dimmable. Driver remoto cuando es dimable.



DRACO ZAHARA

REF 10009.WR

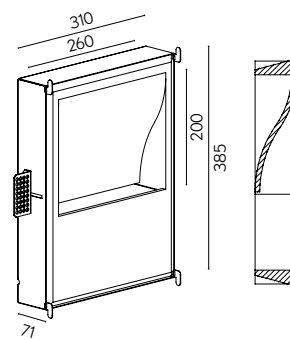
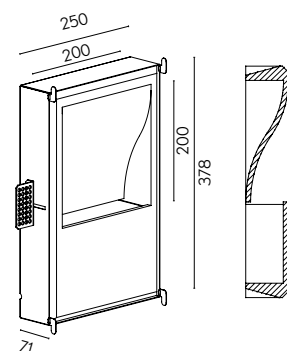

DRACO ORION	REF.	DIMENSIONS	FINISHES	LAMP	DIFFUSER	POWER	CRI	K	LUMEN	WATT	mA	DIMM *1	SKETCH
	10011	.01	.WH-WH	LED	.OP	.ST	.9	.27	387	9	500	.DA .PU .D1	
								.30	430				
								.40	490				
						.HI		.27	783	18	500		
								.30	870				
								.40	980				

Con difusor opal.
With opal optic cover.

LUMINAIRE INCLUDES

Recessed mounting kit

Reference order

10011.XX.WR.WH-WH.OP.XX.9.XX.XX

FINISHES



DIMENSIONS

.01

LIGHTING OPTIONS

DIFFUSER

OPAL

POWER

STANDARD | HI

CRI

90

COLOR TEMPERATURE

2700K | 3000K | 4000K

DIMMABLE OPTIONS

DALI | 1.10 | PUSH

LIGHT DISTRIBUTION

UP

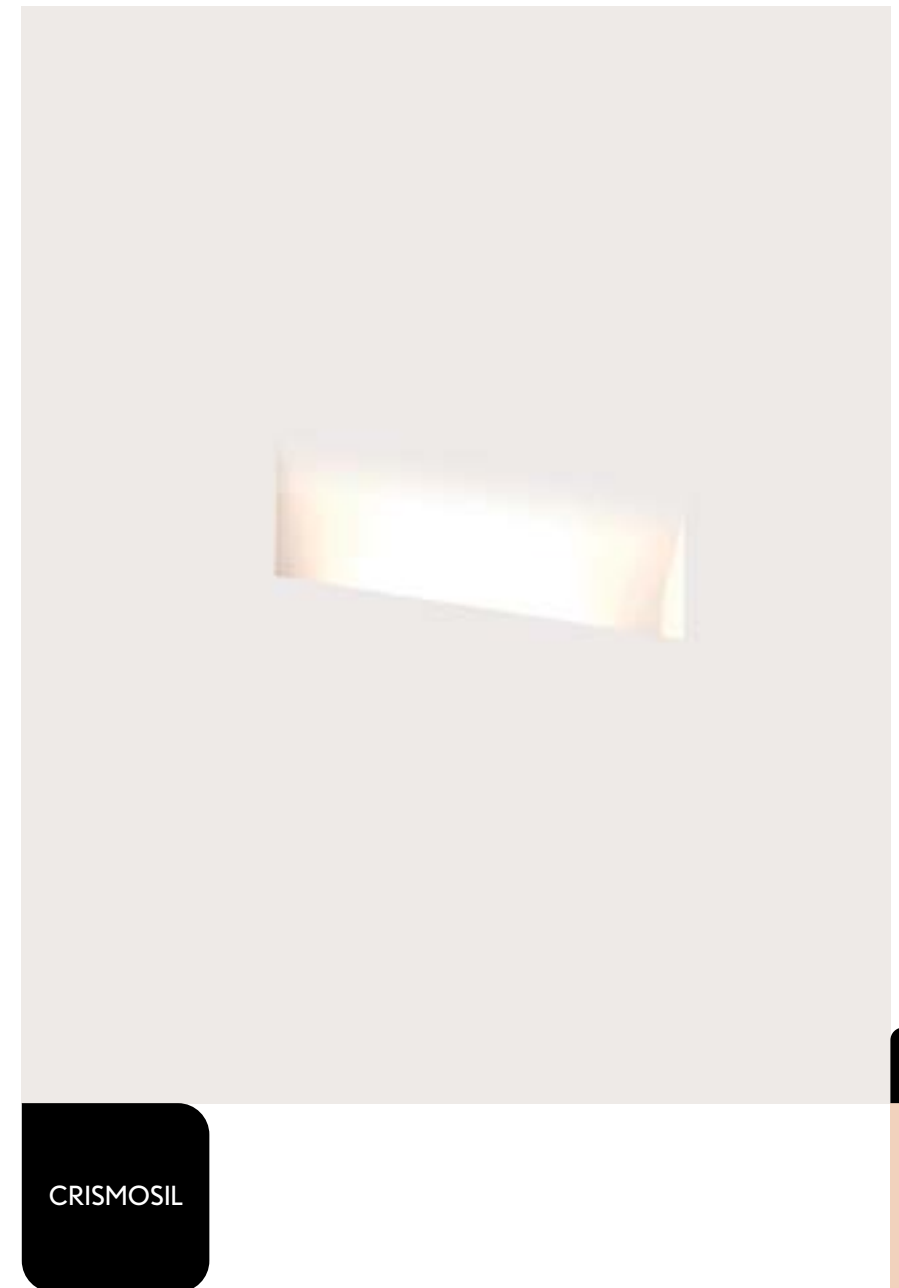

*1 Remote driver when dimmable. Driver remoto cuando es dimable.



DRACO ORION

REF 10011.WR

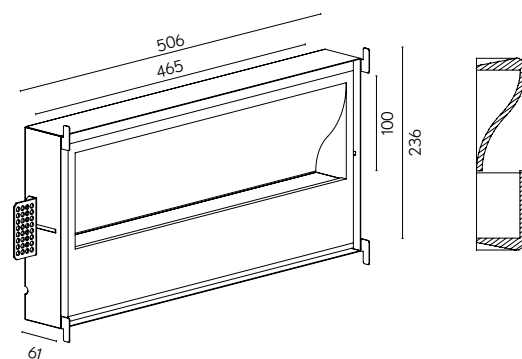

OUTDOOR

VISUAL INDEX

WALL ZEN

IP65



WALL ZEN OUT
11600 PAG. 852

IP65



WALL ZEN SQ OUT
11601 PAG. 854

WALL OUT

IP65



WALL ARA OUT
10006 PAG. 856

IP65



WALL ZAHARA OUT
10009 PAG. 857

IP65



WALL DRACO OUT
10119 PAG. 858

NOCTUA OUT

IP65



new

NOCTUA SQ OUT
10099 PAG. 860

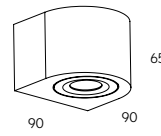
WALL ZEN OUT	REF.	DIMENSIONS	FINISHES	LAMP	OPTIC OPTIONS	POWER	CRI	K	LUMEN	WATT	mA	DIMM*1	SKETCH
	11600	.01	.CEM	LED	.38	.ST	.9	.27	358	9	400	-	
								.30	511				
								.40	505				

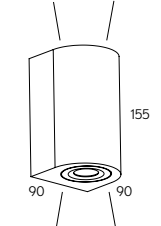
WALL ZEN OUT	REF.	DIMENSIONS	FINISHES	LAMP	OPTIC OPTIONS	POWER	CRI	K	LUMEN	WATT	mA	DIMM*1	SKETCH
	11600	.02	.CEM	LED	.38	.ST	.9	.27	716	18	400	-	
								.30	1022				
								.40	1366				

LUMINAIRE INCLUDES

Surface mounting kit

Reference order | 11600.XX.OUT.WS.CEM.OP.XX.9.XX

FINISHES



DIMENSIONS

.01 | .02

LIGHTING OPTIONS

BEAM ANGLE

38°

POWER

STANDARD

CRI

90

COLOR TEMPERATURE

2700K | 3000K | 4000K

DIMMABLE OPTIONS

-

LIGHT DISTRIBUTION

UP | UP-DOWN (.02)



OUTDOOR

Con difusor opal. With opal optic cover.

*1 Consult Dimm options. Consultar opciones de regulación.

- CEMENT
- 0°
- 0°
- CRI ≥90
- IK08
- IP65
- LIFE 50000H
- INTEGRATED
- INDOOR
- 220-240 V 50-60 Hz
- CE

WALL ZEN OUT

REF 11600.OUT.WS

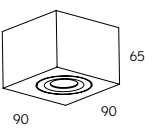
WALL ZEN SQ OUT	REF.	DIMEN-SIONS	FINISHES	LAMP	OPTIC OPTIONS	POWER	CRI	K	LUMEN	WATT	mA	DIMM*1	SKETCH
	11601	.01	.CEM	LED	.38	.ST	.9	.27	358	9	400	-	
								.30	511				
								.40	683				

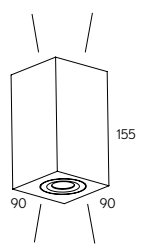
WALL ZEN SQ OUT	REF.	DIMEN-SIONS	FINISHES	LAMP	OPTIC OPTIONS	POWER	CRI	K	LUMEN	WATT	mA	DIMM*1	SKETCH
	11601	.02	.CEM	LED	.38	.ST	.9	.27	716	18	400	-	
								.30	1022				
								.40	1366				

LUMINAIRE INCLUDES

Surface mounting kit

Reference order | 11601.XX.OUT.WS.CEM.38.ST9.XX

FINISHES



DIMENSIONS

.01 | .02

LIGHTING OPTIONS

BEAM ANGLE

38°

POWER

STANDARD

CRI

90

COLOR TEMPERATURE

2700K | 3000K | 4000K

DIMMABLE OPTIONS



LIGHT DISTRIBUTION

UP | UP-DOWN (.02)



OUTDOOR

Con difusor opal. With opal optic cover.

*1 Consult Dimm options. Consultar opciones de regulación.

WALL ZEN SQ OUT

REF 11601.OUT.WS

• FINISHES



• DIMENSIONS

.01

LIGHTING OPTIONS

■ BEAM ANGLE

38°

POWER

STANDARD

CRI

90

COLOR TEMPERATURE

2700K | 3000K | 4000K

▼ DIMMABLE OPTIONS

▲ LIGHT DISTRIBUTION

DOWN



WALL ARA OUT	REF.	DIMENSIONS	FINISHES	LAMP	OPTIC OPTIONS	POWER	CRI	K	LUMEN	WATT	mA	DIMM*1	SKETCH
	10006	.01	.CEM	LED	.38	.ST	.9	.27	226	7	310	-	
								.30	238				
								.40	273				

LUMINAIRE INCLUDES

Recessed mounting kit

Reference order | 10006.01.OUT.WR.CEM.38.ST9.XX

• FINISHES



• DIMENSIONS

.01

LIGHTING OPTIONS

■ BEAM ANGLE

38°

POWER

STANDARD

CRI

90

COLOR TEMPERATURE

2700K | 3000K | 4000K

▼ DIMMABLE OPTIONS

▲ LIGHT DISTRIBUTION

DOWN



WALL ZAHARA OUT	REF.	DIMENSIONS	FINISHES	LAMP	OPTIC OPTIONS	POWER	CRI	K	LUMEN	WATT	mA	DIMM*1	SKETCH
	10009	.01	.CEM	LED	.38	.ST	.9	.27	484	11	470	-	
								.30	510				
								.40	534				

LUMINAIRE INCLUDES

Recessed mounting kit

Reference order | 10009.01.OUT.WR.CEM.38.ST9.XX



WALL ARA OUT
REF 10006.OUT.WR

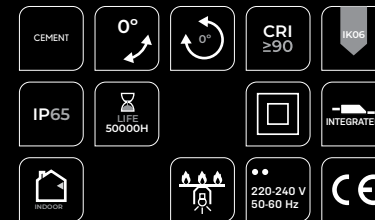

WALL ZAHARA OUT
REF 10009.OUT.WR



OUTDOOR

Con difusor opal. With opal optic cover.
*1 Consult Dimm options. Consultar opciones de regulación.
*1 Remote driver when dimmable. Driver remoto cuando es dimable.

Con difusor opal. With opal optic cover.
*1 Consult Dimm options. Consultar opciones de regulación.
*1 Remote driver when dimmable. Driver remoto cuando es dimable.



new

• FINISHES



• DIMENSIONS

.01

LIGHTING OPTIONS

■ BEAM ANGLE

38°

POWER

STANDARD

CRI

90

COLOR TEMPERATURE

2700K | 3000K | 4000K

▼ DIMMABLE OPTIONS

-

▲ LIGHT DISTRIBUTION

DOWN



WALL DRACO OUT	REF.	DIMEN-SIONS	FINISHES	LAMP	OPTIC OPTIONS	POWER	CRI	K	LUMEN	WATT	mA	DIMM*1	SKETCH
	10119	.01	.CEM	LED	.38	.ST	.9	.27	392	6	290	-	
								.30	413				
								.40	600				

LUMINAIRE INCLUDES

Recessed mounting kit

Reference order | 10119.01.OUT.WR.CEM.38.ST9.XX



OUTDOOR

WALL DRACO OUT

REF 10119.OUT.WR

Con difusor opal. With opal optic cover.
 *1 Consult Dimm options. Consultar opciones de regulación.
 *1 Remote driver when dimmable. Driver remoto cuando es dimable.

new

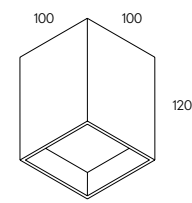
NOCTUA SQ OUT	REF.	DIMENSIONS	FINISHES	LAMP	OPTIC OPTIONS	POWER	CRI	K	LUMEN	WATT	mA	DIMM*1	SKETCH
	10099	.01	CEM	LED	.40	.ST	.8	.30	653	13	550	-	
								.40	786				

LUMINAIRE INCLUDES

Surface mounting kit

Reference order | 10099.01.OUT.SR.CEM.40.ST.8.XX

FINISHES



DIMENSIONS

.03

LIGHTING OPTIONS

BEAM ANGLE

40°

POWER

STANDARD

CRI

80

COLOR TEMPERATURE

3000K | 4000K

DIMMABLE OPTIONS

LIGHT DISTRIBUTION

DOWN



OUTDOOR

*1 Consult Dimm options. Consultar opciones de regulación.

- CEMENT
- 0°
- 0°
- CRI ≥ 80
- IK04
- IP65
- LIFE 50000H
- INTEGRATED
- INDOOR
- 220-240 V 50-60 Hz
- CE

NOCTUA SQ OUT

REF 10099.OUT.SR

PHOTOMETRY

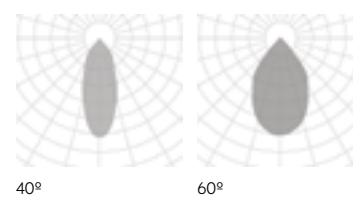

How to create a Reference Order

Como crear la Referencia

When ordering a Florida SQ luminaire, diameter 350 mm, pendant mounting, black external-internal finish, standard power, CRI 90, 2700 K, DALI dimming and indirect light.

Si deseas pedir una luminaria Florida SQ de diámetro 350 mm, suspendida en acabado interior y exterior negro, potencia standard, CRI 90, 2700 K, regulación DALI y con luz indirecta.

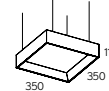
FLORIDA SQ	REF.	DIMENSION	FINISH	DIFFUSER	POWER	CRI	K	DOWNLIGHT			UPLIGHT ▲ UP *1		DIMM ▼	SKETCH
								LUMEN	WATT	mA	LUMEN	WATT		
	10191	.35	.BK-BK	.OP	.ST	.9	.27	2706	27	700	470	7	.DA	

REF.35.PN.BK-BK.OP.ST.9.27.DA.UP
1 2 3 4 5 6 7 8 9 10

1 Select Luminaire's reference
Selecciona la referencia de la luminaria

2 Choose Luminaire's dimensions | See luminaire to confirm dimension criteria
Elige las dimensiones de la luminaria | Ver luminaria para confirmar criterio de dimensiones

3 Confirm Luminaire's Installation
Confirma la instalación de la luminaria

.PN Pendant | Suspendida
.RF Recessed with Frame | Empotrado con marco
.SR Surface | Superficie
.TK Tracklight | Proyector de carril
.TR Trimless | Empotrado
.WR Wall Recessed | Empotrado en pared
.WS Wall Surface | Aplique de pared

4 Pick available finish options
Escoge los acabados de la luminaria

ALUMINIUM | ALUMINIO

- .BK Black | Negro
- .BM Blue Mint | Azul Menta
- .BS Blue Stone | Azul Piedra
- .BC Brown Coffee | Marrón Café
- .CR Copper Rose | Cobre Rosado
- .CB Coral Bronze | Bronce Coral
- .GC Gold Cava | Oro Cava
- .GY Gray | Gris
- .MG Military Green | Verde Militar
- .VC Violet Chiffon | Violeta Chifón
- .WH White | Blanco
- .YM Yellow Mustard | Amarillo Mostaza

5 Select optic options
Selecciona las opciones ópticas

DIFFUSERS | DIFUSORES

- .MP Microprismatic | Microprismático
- .OP Opal | Opal
- .SI Silicone | Silicona
- .TP Transparent | Transparente

BEAM ANGLES | ÁNGULOS HAZ DE LUZ

Refer to Luminaire's light distribution options and choose from a narrow spot to a wider flood
Consulte las opciones de distribución de la luz de las luminarias desde un punto angosto hasta una inundación más amplia

ACOUSTIC | ACÚSTICO

- .50 Acoustic Gray | Gris Acústico
- .51 Acoustic Dark Gray | Gris Oscuro Acústico
- .52 Acoustic Camel | Camel Acústico
- .53 Acoustic Light Blue | Azul Claro Acústico
- .54 Acoustic Dark Blue | Azul Oscuro Acústico
- .55 Acoustic Green | Verde Acústico
- .56 Acoustic White | Blanco Acústico
- .57 Acoustic Black | Negro Acústico
- .60 Acoustic Yellow | Amarillo Acústico
- .61 Acoustic Red | Rojo Acústico

6 Choose Power options
Elige las opciones de Potencia

.HI High | Alta
.ST Standard | Estándar

7 Confirm CRI (color rendering index)
Confirma las opciones de CRI (color rendering index)

.8 80
.9 90

8 Pick Kelvin degrees
Escoge grados Kelvin

.27 2700
.30 3000
.40 4000
.TW Tunable white

CEMENT | CEMENTO

- .CEM Cement | Cemento

CRISMOSIL

- .WH White | Blanco

OTHERS | OTROS

- .SA Striped Aluminum | Aluminio Rayado
- .CH Chrome | Cromo
- .MS Matt Silver | Plata Mate
- .GF Graphite | Grafito

9 Select dimmable options
Selecciona opciones regulación

.D1 1.10
.DA DALI
.PU PUSH / PULSADOR

10 Indirect light
Luz indirecta
.UP Uplight | Luz indirecta

STEP BY STEP

ALUMINIUM | ALUMINIO



.BK Black | Negro



.BC Brown Coffee | Marrón Café



.GC Gold Cava | Oro Cava



.YM Yellow Mustard | Amarillo Mostaza



.BM Blue Mint | Azul Menta

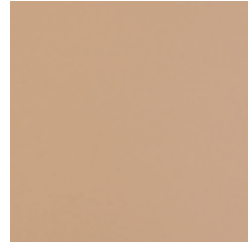

.CR Copper Rose | Cobre Rosado



.GY Gray | Gris

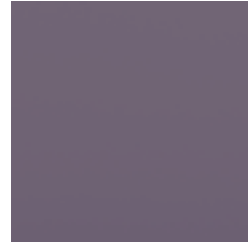

.VC Violet Chiffon | Violeta Chifón



.BS Blue Stone | Azul Piedra

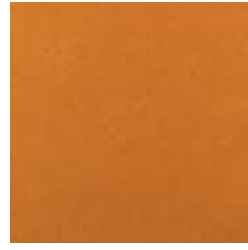

.CB Coral Bronze | Bronce Coral



.MG Military Green | Verde Militar



.WH White | Blanco

ACOUSTIC | ACÚSTICO

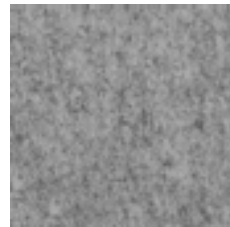

.50
Acoustic Gray
Gris Acústico

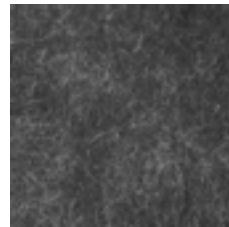

.51
Acoustic Dark Gray
Gris Oscuro Acústico



.52
Acoustic Camel
Camel Acústico



.53
Acoustic Light Blue
Azul Claro Acústico

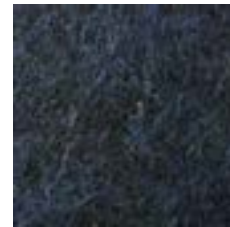

.54
Acoustic Dark Blue
Azul Oscuro Acústico



.55
Acoustic Green
Verde Acústico



.56
Acoustic White
Blanco Acústico



.57
Acoustic Black
Negro Acústico



.60
Acoustic Yellow
Amarillo Acústico



.61
Acoustic Red
Rojo Acústico

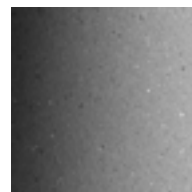

CEMENT | CEMENTO
.CEM
Cement | Cemento



ALUMINIUM | ALUMINIO
.SA
Striped Aluminum | Aluminio Rayado

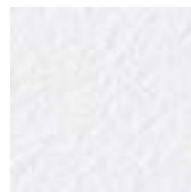

STRUCTURAL
.WH
White | Blanco



Rectangular cut.
Agujero de corte rectangular.



Circular cut.
Agujero de corte circular.



Luminaire not suitable to be covered with thermal insulating material.
Luminaria no adecuada para cubrirse con aislante térmico.



Recessed luminaire suitable for installation on normally inflammable surfaces.
Luminaria empotrada adecuada para montaje en superficies normalmente inflamables.



Surface luminaire suitable for installation on normally inflammable surfaces.
Luminaria superficial adecuada para montaje en superficies normalmente inflamables.



Luminaire with two different IP degrees of protection at the top and bottom.
Grado IP de la luminaria tanto por la parte superior e inferior del empotramiento de la luminaria.



AC input for luminaire is 220-240V / 50-60Hz.
Input AC de luminaria a 220-240V/50-60Hz.



DC output for luminaire is 48 V DC.
Output DC de trabajo de luminaria a 48 V DC.



Driver remote.
Driver remoto.



Driver integrated inside the luminaire.
Driver integrado dentro de la luminaria.



Optional dimmer.
Regulador opcional.



Optional remote dimmer.
Regulador remoto opcional.



Only for indoor use.
Solo para uso interior.



Only for outdoor use.
Solo para uso exterior.



Indoor / outdoor use.
Uso interior / exterior.



Minimum height of the false ceiling.
Altura mínima del falso techo.



Unified Glare Rating.
Índice de Deslumbramiento Unificado.



Luminaire is made of aluminum.
Luminaria fabricada de aluminio.



Luminaire is made of aluminum and silicone.
Luminaria fabricada de aluminio y silicona.



Luminaire is handmade with Crismosil™ material and is designed to have a smooth finish on the front and a raw finish on the back.
Luminaria fabricada a mano con material Crismosil™, diseñada para tener un acabado liso en la parte frontal, mientras que el reverso es en bruto.



Luminaire is made out of cement.
La luminaria está fabricada con cemento.



Rotation degrees.
Grados de giro.



Tilting degree.
Grados de basculación.



Protection rate against external mechanical impacts.
Grado de resistencia contra golpes mecánicos externos.



Luminaire's Lifetime.
Vida útil de la luminaria.



Class I: Luminaire in which the protection against electric shocks falls into a protective conductor grounded.
Clase I: Luminaria en que la protección contra los choques eléctricos recae a un conductor de protección puesto a tierra.



Class II: Luminaire in which the protection against electric shocks includes additional safety features such as double insulation or reinforced insulation.
Clase II: Luminaria en que la protección contra los choques eléctricos, comprende medidas de seguridad suplementarias, tales como el doble aislamiento o el aislamiento reforzado.



Class III: Luminaire in which the protection against electric shocks falls on the power supply with very low safety voltage (SELV) and in which no voltages higher than the very low safety voltage are generated.
Clase III: luminaria en la que la protección contra los choques eléctricos recae en la alimentación con muy baja tensión de seguridad (MTBS) y en la que no se generan tensiones superiores a la muy baja tensión de seguridad.



Luminaire's total length.
Longitud total de la luminaria.



Lamp not included.
Lámpara no incluida.



According to european directives and EN 60598.
Conforme a las directivas europeas y la norma EN 60598.



Surface.
Superficie.



Pendant.
Colgante.



Recessed with frame.
Empotrado con marco.



Trimless.
Empotrado sin marco.



Wall surface.
Aplicue de pared.



Wall recessed.
Empotrado en pared.



Tracklight.
Proyector de carril.

ICON FLASH

Connecting your equipment...

Cómo conecto?

SEVERAL FIXTURES CONNECTION TO A SINGLE CONSTANT CURRENT DRIVER

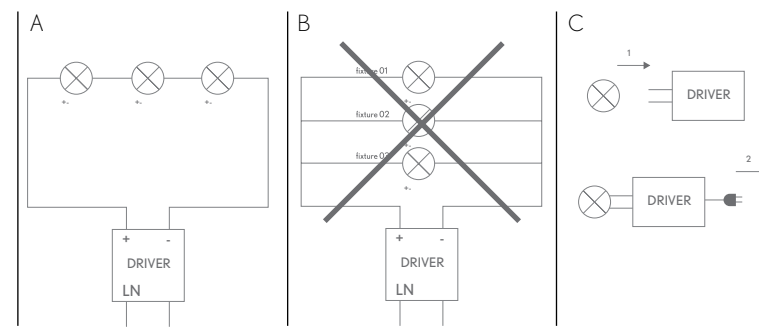

Does

When using a single driver, wire all lighting fixtures in series. LED strips must be wired in parallel.

Don't's

Lighting fixtures must always be connected in no-voltage conditions. The driver must not be connected to the power supply when connecting the lighting fixtures. If there are intermediate connections, follow this diagram to avoid damaging your lighting fixtures. (Diagram) Lighting fixtures must not be connected directly to the AC power source without a driver. Never expose lighting fixtures to heat sources or other electronic equipment.

Consideraciones

Todas nuestras luminarias cuando usan un solo driver se cablearán en serie. Las tiras de led se deberán de cablear en paralelo entre sí.

Advertencias

Las luminarias se deben de conectar siempre apagadas. No se debe de tener el driver conectado a la red encendido al conectar las luminarias. En caso de tener conexiones intermedias se debe de seguir el siguiente esquema para no dañar las luminarias. (Esquema) No se debe de conectar la luminaria directamente al AC sin driver. No se deben de colocar las luminarias cerca de fuentes de calor ni de otros aparatos electrónicos.

Emergency kit

There are two types of emergency lighting: Centralised and single emergency lighting

Centralised emergency lighting

A large battery or generator supplies energy to the emergency lighting fixtures via a specially protected power supply. In this case, the drivers have a DC recognition function that uses the input voltage to detect the emergency mode. The driver automatically turns on the DC mode and controls the light to the set DC level. The DC lighting level is generally 15% of nominal. When the installation enters DC mode, all the sensors stop working.

What do I need?

You only need one DC-ready driver in addition to AC-mode, which is used during normal operation of the lighting fixture. An additional battery or generally must be installed to connect the light fixture driver.

Decentralised emergency lighting

This does not have its own mains supply. An emergency kit consisting of emergency lighting equipment, a battery and LED indicator is required.

How does the emergency kit work?

The emergency kits supplied by BPM are for permanent use, and work normally with your driver and when the general mains network fails. The emergency kit driver detects there is voltage in the network and allows the lighting fixture driver work under normal conditions. In case of a power failure in the grid, the emergency kit driver releases the energy in the battery to power the LEDs.

What do I need?

You need a lighting fixture, its driver and LEDs and an emergency kit. The battery in the emergency kit must be installed separately from the lighting fixture and there must be a space to locate it.

How many emergency kits do I need?

An emergency kit can supply one driver with less than 150W. If the lighting fixture has more than one driver and full lighting is required, you need the same number as emergency kits as drivers in the light fixture. If only one kit is fitted, only the part of the lighting fixture that is associated with the driver will light up.

Kit de emergencia

Existen dos tipos de iluminación de emergencia:

Iluminación de emergencia de alimentación centralizada y descentralizada

Emergencia Centralizada

Una batería grande o generador suministran la energía necesaria para la iluminación de emergencia a través de una red de suministro con una protección especial.

En este caso los drivers tienen una función de reconocimiento DC que usa el voltaje de entrada para detectar el modo de emergencia. El driver automáticamente enciende el modo DC y regula la luz al nivel definido DC. Generalmente el nivel DC de iluminación es del 15% del nominal. Cuando la instalación entra en modo DC todos los sensores dejan de funcionar.

¿Qué necesito?

Sólo se necesita un driver preparado para trabajar en modo DC además de en modo AC, que será el que se use durante el funcionamiento habitual de la luminaria. La instalación debe de estar preparada con una batería o generador adicional donde conectar el driver de la luminaria.

Emergencia Descentralizada.

No cuenta con una red de alimentación propia. Se necesita de kit de emergencia compuesto por un equipo de iluminación de emergencia, una batería y un indicador LED.

¿Cómo funciona el Kit de emergencia?

Los Kit de emergencia suministrados por BPM son de uso permanente, es decir, funciona normalmente con su driver y además cuando falla la red general. El driver del Kit de emergencia comprueba que hay tensión en la red dejando que el driver de la luminaria trabaje en condiciones normales de utilización. Cuando hay un fallo de suministro eléctrico en la red, el driver del kit de emergencia permite liberar la energía acumulada en la batería alimentando los LEDs.

¿Qué necesito?

Se necesita la luminaria compuesta de su driver y LEDs y un kit de emergencia. En cualquier caso, la batería de los Kit de emergencia debe de ir externa a la luminaria por lo que se debe de prever un espacio para su alojamiento

¿Cuántos kit de emergencia necesito?

Con un kit de emergencia se puede dar servicio a un solo driver de potencia inferior a 150W.

Si una luminaria lleva más de un driver y se requiere que se ilumine completamente se necesitarán tantos kits de emergencia como drivers lleve la luminaria. En este caso si sólo se coloca un kit se iluminará únicamente la parte de la luminaria que lleve asociado el driver con el kit de emergencia.

Are BPM light fixtures approved according to standard?

Please note that BPM Lighting luminaires are not in any case, emergency luminaires approved according to the EN-60598-2:22. Our emergency kits provide low anti-panic lighting for between one and three hours in case of a ma in power failure (see ref. ACKITLED1H and ref. ACKITLED3H).

¿Son las luminarias de BPM homologadas según la norma?

Las luminarias de BPM que llevan kit de emergencia en ningún caso son luminarias de emergencia homologadas según la norma EN-60598-2:22. Los kits de emergencia suministrados permiten mantener una iluminación reducida antipánico, durante 1 o 3 horas en caso de fallos de suministro eléctrico de la red (ver ref. ACKITLED1H y ref. ACKITLED3H).

Wiring - EM converter LED BASIC with a standard LED Driver and one LED module for main and emergency operation

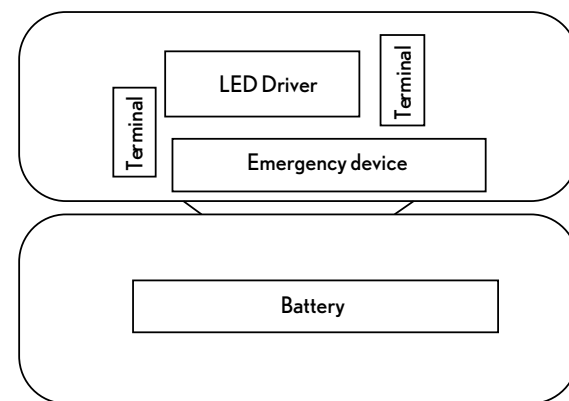
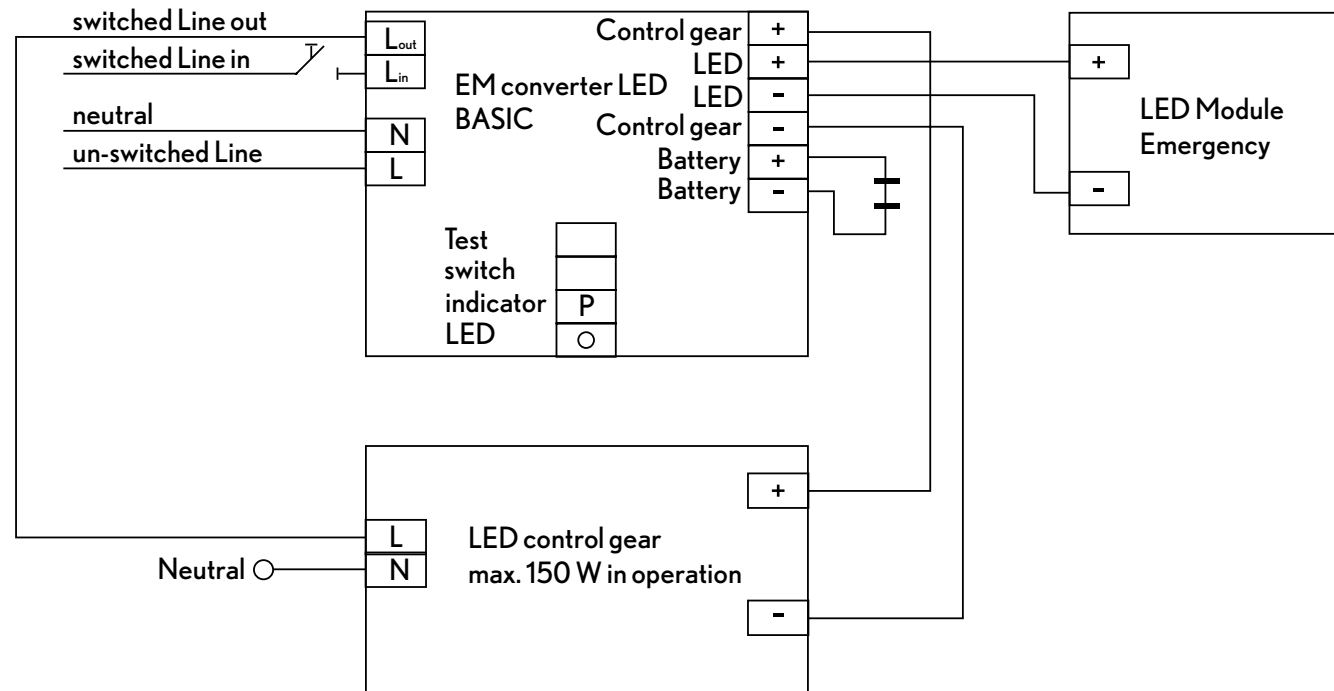

DIMMING OPTIONS

1.10V

How does it work?

The driver generates a 1V (minimum) to 10V (maximum) analogue signal a dimmer switch controller. Dimming from 1 to 100%.

What do I need?

You need an L and N power source plus two control cables with + and - polarity and a compatible 1.10V controller. To switch off, install an ON-OFF switch with a 0.10V driver.

Can I dim the lights in more than one place?

It is not possible to control your lights from more than one point when you install a controller. A conventional switch can be used to switch on and off from several points, but only one of them can be a dimmer.

PHASE CUT

How does it work?

Lights are dimmed by cutting the mains voltage at the beginning (leading) or the end (trailing) of the phase. Dimming: 10/20-100% depending on driver.

The driver may make a noise when dimmed and flickering can occur at the lowest levels.

What do I need?

You only need an L and N power source. An additional control cable is not required, but a phase cut-off regulator is. The dimmer switch must be LED compatible. Always consider the compatibility of the dimmer switch with the driver and whether it is cutting at the trailing or leading end of the phase. The dimmer switch supplier can advise on compatibility.

Can I dim the lights in more than one place?

No. You cannot have more than one dimmer switch. You can only have one from a conventional ON-OFF switch (on and off only).

PUSH

How do they work?

The lights are dimmed with a switch, which is usually on. Press the push button quickly to turn the light on or off, and hold it in for the dimming function. The range is from 1-5% to 100%.

Lighting may go out of synch when a single push button is used. It can usually be synchronised again by holding the button in for a specific time or using a pulse sequence determined by the driver.

What do I need?

All you need is a conventional push button without a pilot light.

No additional control pads are required.

PUSH dimmer switches require an L and N power supply plus an additional cable back to the push button. In some cases the driver needs an additional neutral input which must be bridged with the installation neutral.

Can I control my lights from more than one push button?

You can install several push buttons in a row for multi-point control. In this case, the wire back to the button must enter each driver in parallel and must not be bridged from driver to driver.

You can connect numerous lights to a single button, but the more lights you connect, the greater the risk of loss of synchronisation. The number of devices controlled by a push button depends on the driver (ask the technical team).

DALI

How does it work?

The Digital Addressable Lighting Interface (DALI) system allows you to control each DALI device. By device, we mean the driver and the sensor (not the luminaire). It uses a low-voltage bidirectional communication protocol to send and receive messages. DALI digitally controlled by a standard lighting control protocol under the IEC 62356 standard. Control from 1-5% to 100% DALI keeps your lighting in sync.

Features:

DALI devices per BUS: 64

Number of DALI groups per BUS: 16

Number of DALI scenarios per BUS: 16

DALI Voltage: 9.5-22.5v, typically 16V

DALI system current: Max. 250 mA.

Maximum cable length: 300 m with a cross-section of 1.5 mm²

What do I need?

You need an L and N power supply plus two control signal wires. These control cables must be powered by a DALI BUS.

You also need regulators with DALI protocol support.

Can I dim the lights in more than one place?

There are two options: By means of DALI panels/interfaces directly connected to the DALI BUS that consume a DALI address for each panel placed and must be programmed; or through DALI dimmer switches that are connected to 230V_aC and work by means of short presses to turn on/off and long presses to dim.

CÓMO REGULO?

1.10V

¿Cómo funciona?

El driver genera una señal analógica de 1V (mínimo) a 10V (máximo) que llega a un controlador que regula la intensidad lumínica.

Regulación del 1 al 100%.

¿Qué necesito?

Se necesita una alimentación L y N más dos cables de control con polaridad + y - y un controlador compatible 1.10V.

Si se quiere apagar se necesita colocar un regulador con ON-OFF o bien regular mediante driver 0.10V.

¿Puedo regular desde varios puntos?

No es posible regular desde varios puntos cuando se coloca un controlador. Se puede utilizar un interruptor convencional conmutado de manera que se pueda encender y apagar desde varios puntos pero sólo uno de ellos podrá regular.

CORTE DE FASE

¿Cómo funciona?

La regulación se realiza mediante corte de la onda de la tensión de red al inicio (leading) o al final (trailing) de la fase.

Regulación: 10/20-100% dependiendo del driver.

Puede generar ruido en el driver y al regular la intensidad al mínimo puede generar flickering.

¿Qué necesito?

Sólo necesita alimentación L y N. No necesita cable adicional de control, pero sí un regulador de corte de fase.

El regulador debe de ser compatible con LED. Se debe de tener en cuenta la compatibilidad del regulador con el driver y si es corte por trailing o leading. Dicha compatibilidad la dará el proveedor del regulador.

¿Puedo regular desde varios puntos?

No se puede regular desde varios puntos. Sólo se puede regular desde un punto y conmutar el ON-OFF desde el interruptor convencional (sólo para encender y apagar).

PUSH

¿Cómo funciona?

Regulación a través de un pulsador normalmente abierto. La regulación se realiza con pulsaciones cortas para apagar/encender y una pulsación mantenida para el control de la intensidad lumínica.

Regulación del 1-5% al 100%.

Puede aparecer desincronización en la regulación de las luminarias con un solo pulsador. Se suele re-sincronizar generalmente con una pulsación mantenida durante un tiempo determinado o con una secuencia de pulsación determinada según el driver.

¿Qué necesito?

Se requiere de pulsadores convencionales sin piloto de luz y no necesita ningún tipo de pastilla de regulación adicional.

La regulación PUSH necesita de alimentación L y N más un cable adicional de vuelta al pulsador. En algunos casos el driver puede necesitar una entrada adicional de neutro que debe de puentearse con el neutro de la instalación.

¿Puedo regular desde varios puntos?

Es posible colocar varios pulsadores en paralelo para control desde varios puntos. En este caso, el cable de vuelta al pulsador debe entrar a cada driver en paralelo y no se debe de puentear de un driver a otro.

Es posible colocar varios equipos a un mismo pulsador, pero a mayor cantidad de equipos mayor riesgo de desincronización.

El número de equipos soportados por un pulsador dependerá del driver (Consultar con el equipo técnico).

DALI

¿Cómo funciona?

El sistema de regulación DALI (Digital Addressable Lighting Interface) permite el control de cada dispositivo DALI. Se entiende por dispositivo el driver y el sensor (no la luminaria). Utiliza un protocolo de comunicación bidireccional de bajo voltaje que permite enviar y recibir mensajes.

Se regula de forma digital mediante un protocolo estándar de control de iluminación bajo el estándar IEC 62356. Regulación del 1-5% al 100%

Con DALI se evita cualquier tipo de desincronización.

Características:

Dispositivos DALI por cada BUS: 64

Cantidad de grupos DALI por cada BUS: 16

Cantidad de escenas DALI por cada BUS: 16

Tensión DALI: 9.5-22.5v, normalmente 16V

Corriente del sistema DALI: máx. 250mA.

Máxima longitud del cable: 300m con una sección transversal de 1.5mm²

¿Qué necesito?

Necesita alimentación L y N más dos cables de señal de control.

Estos cables de control deben de estar alimentados mediante un BUS DALI.

Además, son necesarios reguladores que deben de indicar su compatibilidad con protocolo DALI.

¿Puedo regular desde varios puntos?

Existen dos opciones: Mediante paneles/interfaces DALI conectados directamente al BUS DALI que consumen una dirección DALI por cada panel colocado y que deben de ser programados; o a través de interruptores reguladores DALI que van conectados a 230V_aC y funcionan mediante pulsaciones cortas para encender/apagar y pulsaciones mantenidas para regular.

TECH RECOMMENDATIONS RECOMENDACIONES TÉCNICAS

PUSH: OPTION 1

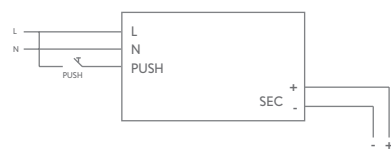

PUSH: OPTION 2

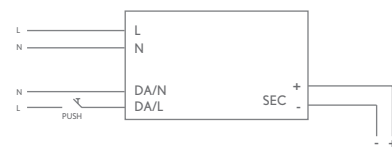

DALI

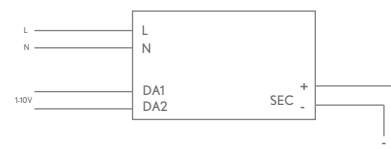

1-10V

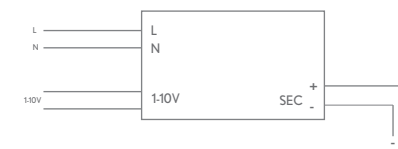

PHASE CUT

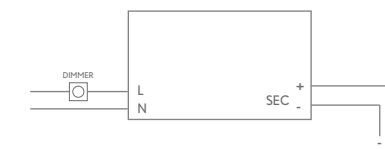

As IEC 60529 standard says, the IP protection degree specifies the different protection levels provided by the containers that protect the components in electrical or electronic equipment. The greater the IP protection degree, the more protected the equipment is. An IP XY protection degree indicates the following:

Según la Norma IEC 60529, el grado de protección IP especifica los diferentes niveles de protección aportados por los contenedores que resguardan los componentes de los equipos eléctricos o electrónicos. Cuanto mayor es el grado de protección IP, más protegido está el equipamiento. Un grado de protección IP XY indica lo siguiente:

X: Describes the level of protection against dust and other particles / Describe el nivel de protección contra polvo y otras partículas

X	Protection grade against dust / Grado de protección contra polvo
0	Without protection / Sin protección
1	Protected against solids bigger than 50 mm / Protegida contra sólidos de más de 50 mm
2	Protected against solids bigger than 12 mm / Protegida contra sólidos de más de 12 mm
3	Protected against solids bigger than 2,5 mm / Protegida contra sólidos de más de 2,5 mm
4	Protected against solids bigger than 1 mm / Protegida contra sólidos de más de 1 mm
5	Protection against the entrance of dust / Protegida contra la entrada de polvo
6	Full protected against dust / Totalmente protegida del polvo

Y: Describes the level against liquids / Describe el nivel de protección contra líquidos

Y	Protection grade against liquids / Grado de protección contra líquidos
0	Without protection / Sin protección
1	Protected against drops of water falling vertically / Protegida contra la caída vertical de gotas de agua
2	Protected against drops of water falling at a maximum inclination of 15° Protegida contra la caída de gotas de agua con una inclinación máxima de 15°
3	Protected against sprayed water / Protegida contra agua pulverizada
4	Protected against splashes of water / Protegida contra las proyecciones de agua
5	Protected against jets of water / Protegida contra los chorros de agua
6	Protected against high pressure jets of water / Protegida contra chorros de agua a alta presión
7	Protected against plunging effects / Protegida contra los efectos de la inmersión
8	Protected against long immersion / Protegida contra la inmersión prolongada

*Specialized cleaning procedures are not covered by IP ratings. It is recommended that manufacturers provide, if necessary, adequate information regarding cleaning procedures. This is in accordance with the recommendations contained in IEC 60529 for special cleaning procedures.

*Los procedimientos especializados de limpieza no están cubiertos por los grados de protección IP. Se recomienda que los fabricantes suministren, si es necesario, una adecuada información en lo referente a los procedimientos de limpieza. Esto está de acuerdo con las recomendaciones contenidas en la Norma IEC 60529 para los procedimientos de limpieza especiales.

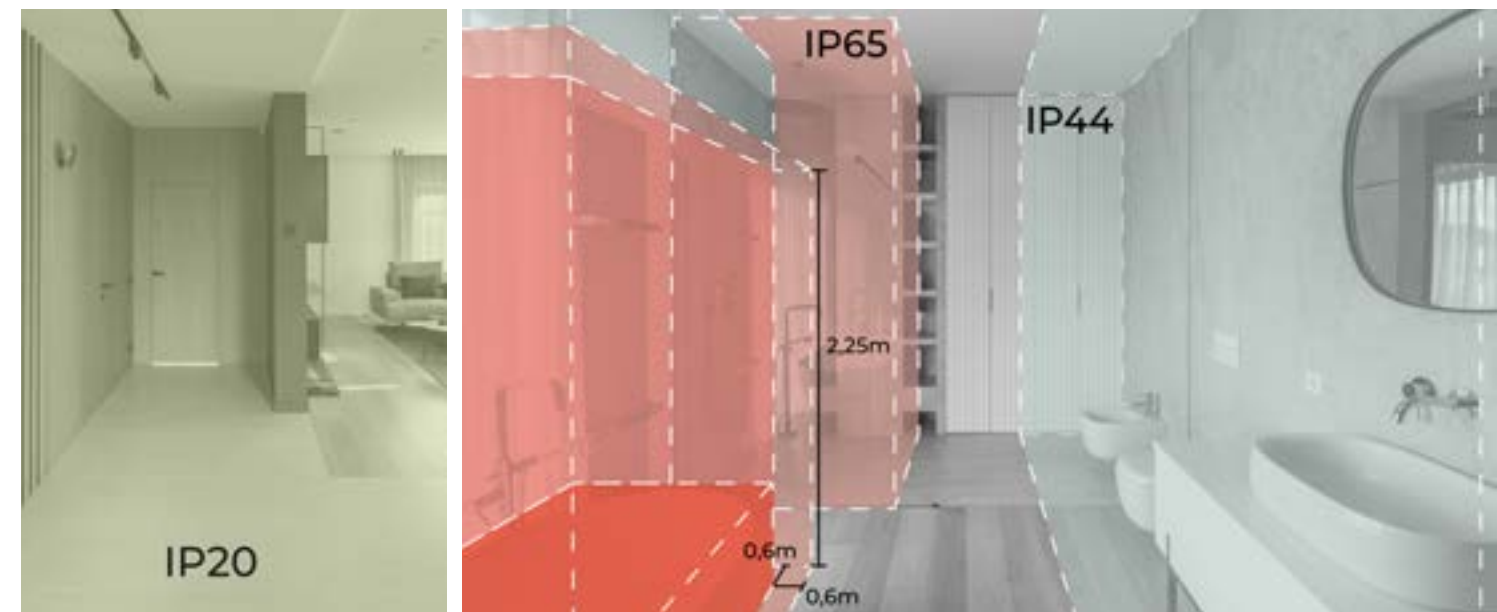

IP DEGREE OF PROTECTION GRADO DE PROTECCIÓN IP

TECH RECOMENDATIONS RECOMENDACIONES TÉCNICAS

IK DEGREE GRADO IK

The degree of protection IK is an international numerical classification for the degrees of protection provided by enclosures of electrical equipment against external mechanical impacts. This provides a means of specifying the ability of an enclosure to protect its contents from shock.

El grado de protección IK es una clasificación numérica internacional para los grados de protección proporcionados por las envolventes de materiales eléctricos contra los impactos mecánicos externos. Esto proporciona un medio para especificar la capacidad de un recinto para proteger su contenido de los golpes.

IK DEGREE GRADO IK	PROTECTION AGAINST EXTERNAL MECHANICAL IMPACTS PROTECCIÓN CONTRA IMPACTOS MECÁNICOS EXTERNOS	DESCRIPTION DESCRIPCIÓN
IK00	No protection / Sin proteger	
IK01	Protected against 0.150J impact. <i>Protegido contra impacto de energía 0.150J.</i>	Resistant against an impact of an object of 200 grs launched from a distance of 7.5 cm. <i>Resistente contra un impacto de un objeto de 200 grs lanzado desde una distancia de 7,5 cm.</i>
IK02	Protected against 0.200J impact. <i>Protegido contra impacto de energía 0.200J.</i>	Resistant against an impact of an object of 200 grs launched from a distance of 10 cm. <i>Resistente contra un impacto de un objeto de 200 grs lanzado desde una distancia de 10 cm.</i>
IK03	Protected against 0.350J impact. <i>Protegido contra impacto de energía 0.350J.</i>	Resistant against an impact of an object of 200 grs launched from a distance of 17.5 cm. <i>Resistente contra un impacto de un objeto de 200 grs lanzado desde una distancia de 17,5 cm.</i>
IK04	Protected against 0.500J impact. <i>Protegido contra impacto de energía 0.500J.</i>	Resistant against an impact of an object of 200 grs launched from a distance of 25 cm. <i>Resistente contra un impacto de un objeto de 200 grs lanzado desde una distancia de 25 cm.</i>
IK05	Protected against 0.700J impact. <i>Protegido contra impacto de energía 0.700J.</i>	Resistant against an impact of an object of 200 grs launched from a distance of 35 cm. <i>Resistente contra un impacto de un objeto de 200 grs lanzado desde una distancia de 35 cm.</i>
IK06	Protected against 1.00J impact. <i>Protegido contra impacto de energía 1.00J.</i>	Resistant against an impact of an object of 500 grs launched from a distance of 20 cm. <i>Resistente contra un impacto de un objeto de 500 grs lanzado desde una distancia de 20 cm.</i>
IK07	Protected against 2.00J impact. <i>Protegido contra impacto de energía 2.00J.</i>	Resistant against an impact of an object of 500 grs launched from a distance of 40 cm. <i>Resistente contra un impacto de un objeto de 500 grs lanzado desde una distancia de 40 cm.</i>
IK08	Protected against 5.00J impact. <i>Protegido contra impacto de energía 5.00J.</i>	Resistant against an impact of an object of 1,7 kg launched from a distance of 29,5 cm. <i>Resistente contra un impacto de un objeto de 1,7 kg lanzado desde una distancia de 29,5 cm.</i>
IK09	Protected against 10.00J impact. <i>Protegido contra impacto de energía 10.00J.</i>	Resistant against an impact of an object of 5 kg launched from a distance of 20 cm. <i>Resistente contra un impacto de un objeto de 5 kg lanzado desde una distancia de 20 cm.</i>
IK10	Protected against 20.00J impact. <i>Protegido contra impacto de energía 20.00J.</i>	Resistant against an impact of an object of 5 kg launched from a distance of 40 cm. <i>Resistente contra un impacto de un objeto de 5 kg lanzado desde una distancia de 40 cm.</i>

CLASS PROTECTION CLASES DE PROTECCIÓN

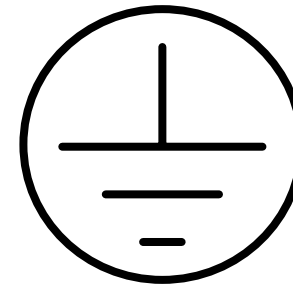

Class I:

Light fittings in which protection against electric shocks does not depend solely on the mains insulation, but instead contain an extra safety measure in the form of a circuit from the accessible conductive parts with an grounded protective conductor forming part of the installation's fixed wiring, so that the accessible conductive parts do not become dangerous should there be a defect in the mains insulation. Ground conductor is coloured green&yellow in most countries, and just green in the U.S., Canada and Japan.

Clase I:

Luminarias en la que la protección contra los choques eléctricos no recae exclusivamente sobre el aislamiento principal, sino que comprende una medida de seguridad suplementaria bajo la forma de medios de conexión de las partes conductoras accesibles con un conductor de protección puesto a tierra, formando parte del cableado fijo de la instalación, de tal manera que las partes conductoras accesibles no puedan llegar a ser peligrosas, en caso de defecto del aislamiento principal. La toma tierra es de color amarillo y verde en la mayoría de los países, y verde en los Estados Unidos, Canadá y Japón.

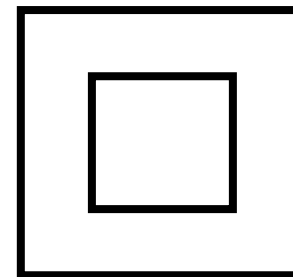

Class II:

A Class II or double insulated electrical appliance is one which has been designed in such a way that it does not require a safety connection to electrical ground. The basic requirement is that no single failure can result in dangerous voltage becoming exposed so that it might cause an electric shock and that this is achieved without relying on an earthed metal casing. This is achieved having two layers of insulating material surrounding live parts or by using reinforced insulation.

Clase II:

Dispositivo de Clase II o aparato con doble aislamiento eléctrico es uno que ha sido diseñado de tal forma que no requiere una toma a tierra de seguridad eléctrica. El requisito básico es que un fallo simple no puede dar lugar a tensiones peligrosas que puedan causar una descarga eléctrica. Esto se consigue mediante dos capas de material aislante rodeando las partes con tensiones peligrosas o utilizando un aislamiento reforzado.

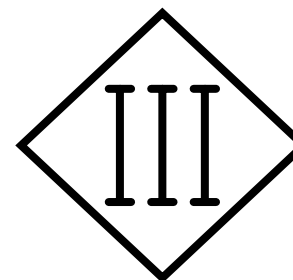

Class III:

A Class III appliance is designed to be supplied from a separated/safety extra-low voltage (SELV) power source. The voltage from a SELV supply is low enough that under normal conditions a person can safely come into contact with it without risk of electrical shock. The extra safety features built into Class I and Class II appliances are therefore not required. For medical devices compliance with Class III is not considered sufficient protection.

Clase III:

Un aparato de Clase III está diseñado para ser alimentado por una fuente de alimentación SELV (por sus siglas en inglés: "Separated or Safety Extra-Low Voltage"). La tensión de una fuente de SELV es lo suficientemente baja para que, en condiciones normales, una persona puede entrar en contacto con ella sin correr el riesgo de descarga eléctrica. Por tanto, no es necesario incorporar la seguridad que llevan los aparatos de Clase I y Clase II. Para el cumplimiento de los dispositivos médicos la Clase III no se considera suficiente para su protección.



GENERAL TERMS AND CONDITIONS OF SALE

All orders must be placed with BPM Iluminación S.L in writing by email, and customers hereby accept the terms and conditions detailed below. Goods supplied by the Company shall remain the property of BPM Iluminación S.L until payment is received, even if the goods have been sold to a third party. Delivery times are approximate and non-binding. BPM Iluminación S.L will not accept claims for damages due to late delivery. BPM Iluminación S.L reserves the right to amend, supplement or delete, without prior warning, the characteristics or designs of the products in this catalogue, as well as the corresponding prices. Therefore, customers are advised to contact BPM Iluminación S.L directly for the latest information. BPM Iluminación S.L is not responsible for any issues caused by the loss or damage of goods during transportation by the carrier. In accordance with Article 1 of Royal Decree 5/1997 of 14 January, complaint forms are available to our customers at the Company's registered office.

CANCELLING AN ORDER

Orders must be cancelled in writing and sent to BPM Iluminación S.L by email. If the order has already been dispatched, please request a refund, in accordance with the terms and conditions detailed in the following section.

RETURNING GOODS BPM

Lighting reserves the right to accept or reject return requests received. Returns must be made within 2 weeks of the invoice date, and a minimum depreciation rate of 15% will be applied to cover handling costs. Depending on the state of conservation of the luminaire, this percentage might be increased.

RETURN TERMS AND CONDITIONS

Return requests must be made in writing by email. Please send all returns correspondence to the email address info@bpmlighting.com, stating, at the very least, the reason for the return, article reference number(s), quantity, item condition, date and invoice number. If the return is authorised: The item must be returned in its original packaging and in perfect condition. BPM Iluminación S.L must receive the goods within a maximum of 10 days after the return has been authorised. Any costs for returning the goods are the responsibility of the customer. Returned goods will not be accepted in the case of discontinued or customised items, any RAL other than black and white, line systems and acoustic products.

Please send the item, together with the documentation required by the Sales Department, to the following address: Partida Madrigueres Sud, 11, 03700 Dénia (Alicante), Spain. It is essential that the return authorization is attached to the package so that the material is not rejected.

WARRANTY

BPM Iluminación S.L guarantees its luminaires and all the components it distributes.

1. BPM Iluminación S.L products are guaranteed against any manufacturing defects (components and labor) for a period of 5 years from the date of purchase.
2. On the basis of this warranty, BPM Iluminación S.L. is only obliged to repair or replace the product or defective part returned to BPM Iluminación S.L.
3. In any case, the guarantee does not include installation, assembly or disassembly costs....

The warranty period starts from the date of issue of the original invoice from BPM Iluminación S.L, and under no circumstances shall it be renewed by replacing a component in a repair or by replacing the complete item.

WARRANTY TERMS AND CONDITIONS

Incident claims (for products that are damaged, faulty, incorrect, or any other cause for complaint upon delivery) must be made in writing by email. Please send all incident claims to email address info@bpmlighting.com, stating, at the very least, the reason for the incident, article reference number(s), quantity, date and invoice number. If the incident claim is authorised by invoking the warranty: The Sales Department will provide an incident code to process the claim. Please send the item, together with the documentation required by the Sales Department and the incident code, to the following address: Partida Madrigueres Sud, 11, 03700 Dénia (Alicante), Spain. It is essential that the documentation is attached to the package so that the material is not rejected.

For incidents due to breakage, wrong references or incorrect quantities, you have a period of 10 days to make a claim.

Once BPM Iluminación S.L has authorised the collection of the item due to an incident, and once the Technical Department has verified that BPM Iluminación S.L is responsible for the source of the incident, the postage will be covered by BPM Iluminación S.L.

These warranty terms and conditions do not affect the consumer's statutory rights under the current applicable legislation.

WARRANTY INVALIDATION CLAUSES

No warranty will be assumed for improper use, handling or maintenance of a luminaire, equipment or component that has not been installed, handled, repaired or maintained according to the recommendations stated in the mounting instructions.

Defects and damage resulting from external events and significant accidents, including but not limited to electrical accidents and natural disasters, are not covered under any warranty.

In the event that the warranty is voided as determined by the technical department, the customer will have 30 days to collect the material once notified; otherwise, it will be discarded.

SALES CONDITIONS

CONDICIONES GENERALES DE VENTA

Todos los pedidos deberán ser formulados a BPM Iluminación S.L. por escrito vía e-mail, quedando aceptadas por el cliente las condiciones escritas a continuación. La mercancía suministrada por la Empresa, será propiedad de BPM Iluminación S.L. hasta el momento de pago, aunque dicha mercancía hubiese sido vendida a un tercero.

Los plazos de entrega son aproximados y sin compromiso. BPM Iluminación S.L. no aceptará demandas por daños y perjuicios por la demora en la entrega.

BPM Iluminación S.L. se reserva el derecho de modificar, complementar o suprimir, sin previo aviso, las características o diseños de los productos presentes en este catálogo, así como sus correspondientes tarifas. Por este motivo, se recomienda al cliente ponerse en contacto directamente con BPM Iluminación S.L. para obtener una información actualizada.

BPM Iluminación S.L. no es responsable de los problemas generados por la pérdida o deterioro de la mercancía durante el transporte por agencia.

De acuerdo con el art. 1 del RD 5/1997 14 Enero, existen a disposición de nuestros clientes hojas de reclamación en el domicilio social de la Empresa.

ANULACIÓN DE PEDIDOS

Las anulaciones de pedidos deberán hacerse por escrito y notificarse a BPM Iluminación S.L. vía e-mail. En caso de que el pedido ya se hubiese enviado, deberá solicitarse la devolución del mismo, acogiéndose a las condiciones detalladas en el siguiente apartado.

DEVOLUCIÓN DE MERCANCÍA

BPM Iluminación S.L. se reserva el derecho de autorizar y aceptar las solicitudes de devolución recibidas. En cualquier caso, se requerirá que no hayan transcurrido 15 días desde la fecha de la factura, y se aplicará una depreciación mínima del 15% por los costes de gestión. Dependiendo del estado de conservación de la luminaria, este porcentaje podrá incrementarse.

CONDICIONES DE DEVOLUCIÓN

La solicitud de devolución deberá formalizarse por escrito vía e-mail. Las devoluciones deberán tramitarse en la siguiente dirección de correo: info@bpmlighting.com.

Deberá informar a BPM Iluminación S.L. por escrito del motivo de la devolución, referencia de artículo/s, cantidad, estado del material, fecha y número de factura.

En el caso de que la devolución fuera autorizada:

El material deberá devolverse en su embalaje original y en perfecto estado de conservación.

BPM Iluminación S.L. deberá recibir la mercancía en un plazo máximo de 10 días desde la autorización de la devolución.

Los portes de la devolución serán asumidos por el cliente.

No se admitirán devoluciones de mercancía en el caso de material descatalogado, material customizado, cualquier RAL distinto al blanco y negro, líneas y productos acústicos.

Es imprescindible que la autorización de devolución se adjunte al bulto para que el material no sea rechazado.

El material deberá ser enviado, junto con la documentación requerida por el Área Comercial, a la siguiente dirección: Partida Madrigueres Sud, 11, 03700 Dénia (Alicante).

GARANTÍA

BPM Iluminación S.L. garantiza sus luminarias, así como los equipos que distribuye.

1 - Los productos de BPM Iluminación, S.L. están garantizados contra cualquier defecto de fabricación (componentes y mano de obra) durante un periodo de 5 años a partir de la fecha de compra.

2 - En razón de esta garantía, sólo incumbe a BPM Iluminación, S.L. la obligación de reparar o reemplazar el producto, o la pieza reconocidos como defectuosos y devueltos a BPM Iluminación, S.L.

3 - En cualquier caso, la garantía no incluye los gastos de instalación, montaje o desmontaje...

El plazo de garantía se inicia a partir de la fecha de emisión de factura originaria de BPM Iluminación S.L., no pudiendo ser renovado en ningún caso por sustitución de un componente en una reparación o reposición del artículo completo.

CONDICIONES DE GARANTÍA

La reclamación por incidencia (que el producto se entregue deteriorado, averiado, equivocado, o cualquier otra causa susceptible de reclamación), deberá formalizarse por escrito vía e-mail.

Las reclamaciones por incidencia deberán tramitarse en la siguiente dirección de correo: info@bpmlighting.com.

Para las incidencias por roturas, referencias erróneas o cantidades incorrectas, dispone de un plazo de 10 días para su reclamación.

Es imprescindible que la documentación vaya adjunta al bulto para que el material no sea rechazado, e indicar el motivo de la incidencia, referencia de artículo/s, cantidad, fecha y número de factura.

En el caso de que la reclamación por incidencia fuera autorizada invocando la garantía:

El Área Comercial proporcionará un código de incidencia para la tramitación. El material deberá ser enviado, junto con la documentación requerida por el Área Comercial, con referencia al código de incidencia facilitado, a la siguiente dirección: Partida Madrigueres Sud, 11, 03700 Dénia (Alicante).

Autorizada por BPM Iluminación S.L. la recogida del material por incidencia, y una vez verificada por el Área Técnica la responsabilidad del origen de la incidencia de BPM Iluminación S.L., los portes serán asumidos por BPM Iluminación S.L.

Estas condiciones de garantía no afectan a los derechos estatutarios del consumidor amparados por la legislación vigente aplicable.

CLÁUSULAS DE ANULACIÓN DE LA GARANTÍA

No se asumirá la garantía del incorrecto funcionamiento de desgaste o desperfecto que presente una luminaria, equipo o componente que no hayan sido instalados, manipulados, reparados o mantenidos acorde a las recomendaciones de las instrucciones de instalación.

Quedan excluidos de toda garantía el incorrecto funcionamiento, desgaste o desperfecto producido por causa externa o fuerza mayor (accidente eléctrico, catástrofe natural, etc).

En caso de anulación de la garantía dictaminada por el departamento técnico, una vez notificado, el cliente dispondrá de 30 días para retirada del material, en caso contrario se desechará.

CONDICIONES DE VENTA



Let's get brighter, let's co-create, let us support you step by step, because our goal is to help you design the perfect lighting solution for your project.

Co-creemos, déjanos ayudarte con lo que mejor sabemos hacer, luz, porque nuestro objetivo es diseñar la perfecta solución lumínica para tu proyecto.



ALARIK SLIM COMPOSITION | BUSINESS HUB VISUALIZATION
ARCHITECTURE: IN COLLABORATION WITH CRYSTALZOO

Scan to find out more detail about our products
Escanea y descubre todo sobre nuestros productos



BPM Lighting S.L. reserves the right to reproduce total or partially this catalogue as Copyright owner.

The content is up to date at the day of print, nevertheless, due to continuous product development and improvement, BPM Lighting reserves the right to alter it without prior notice.

Last catalogue version in [bpmlighting.com](https://www.bpmlighting.com)

BPM Lighting S.L. se reserva el derecho de reproducción total o parcial de este catálogo como propietario del Copyright.

El contenido está actualizado en la fecha de impresión, sin embargo, debido al continuo desarrollo y mejora de los productos, BPM Lighting se reserva el derecho de modificarlo sin previo aviso.

Última versión de catálogo en [bpmlighting.com](https://www.bpmlighting.com)

BPM Lighting Copyright © 2024

Design and layout / Diseño y maquetación
BPM Lighting Team / Equipo BPM Lighting

