

DURA

LAMP

Professional
Lighting



2022

INDEX

Photographic index	2
The Group	6
Our identity	8
The website	14
Green me	18
LED TABLE LAMP	26
DOWNLIGHTS	30
TRACKLIGHT	52
LED PANELS	68
FIXTURES FOR RETROFIT LAMP	98
INDUSTRIAL	120
OUTDOOR	144
DRIVER AND CONTROLLERS	166
Info Tech	180
Index	188
Sales Conditions	191

Indoor

LED TABLE LAMP

26

NEW



28 PLUS
MARAMA

DOWNLIGHTS

30

NEW



34 BASIC
LESELI SC

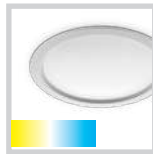

36 BASIC
LESELI CCT



38 BASIC
LESELI DS
SLIM



40 BASIC
LESELI SLIM

NEW



42 PRO
RTF100



44 PRO
HELIOS IP65 CCT



46 PRO
HELIOS IP65

NEW



48 PRO
HELIOS UGR

NEW



50 BASIC
VALO MINI

NEW



51 PRO
LESELI MINI
PRO

MINI DOWNLIGHTS

TRACKLIGHT

52

NEW



54 PLUS
DURA BEAM
TRACK LIGHT



58 PRO
PROJECTOR
DURA TL

NEW



62
EUROSTANDARD
PLUS

NEW



101 PLUS
DURABLE TRACK
GU10



102 BASIC
SPOT-V E27

Indoor

LED PANELS

68



74 BASIC
SLIMFLUX SL
+ UGR

NEW



76 BASIC
SLIMFLUX BL

NEW



78 PLUS
SLIMFLUX BL
+ UGR



80 PLUS
SLIMFLUX BL
PLAFO + UGR

NEW



82 PRO
SLIMFLUX SL
+ UGR



84 PRO
SLIMFLUX BL
+ UGR

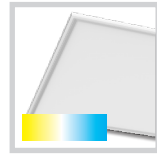

86 PRO
SLIMFLUX BL
UGR CCT

NEW



88 PRO
SLIMFLUX
SL+BL NEX
IP65

NEW



90 PRO
SLIMFLUX Q4

NEW



92 PLUS
SLIMFLUX
PANEL ROUND
60

NEW



94 PLUS
SLIMFLUX PANEL
UP&DOWN
TRANSLUCENT
DIMMABLE PANEL

NEW



96
SLIMFLUX
ACCESSORIES

Indoor / Outdoor

FIXTURES FOR RETROFIT LAMP

98

NEW



103 PLUS
DURABLE TRACK
GU10



104 BASIC
SPOT-V E27

NEW



105 PLUS
DURABLE
SUSPENSION
GU10



107 BASIC
SUSPENSION
E27

NEW



108 PLUS
DURABLE WALL
ROUND

NEW



109 PLUS
DURABLE WALL
BRICK

NEW



111 PLUS
DURABLE
WALKABLE IP65



112 PLUS
CATENERIA



113 BASIC
CATENERIA

Indoor / Outdoor

NEW



114 BASIC

DURABLE
ZKR2

NEW



115 BASIC

DURABLE
ZKR1



116 BASIC

ZKRR - ORIENTABLE
RECESSABLE RING



117 PLUS

ZK4 -
RECESSABLE
RING IP65



118 BASIC

ZK4 -
RECESSABLE
RING IP20

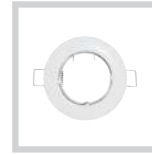

119 BASIC

ZK4 -
RECESSABLE
RING IP20

Industrial

120

BATTEN



122 BASIC

FILINO T5



124 PRO

BATTEN BT3
IP65

NEW



126 BASIC

TRIPROOF
S2T IP65

HIGH BAY



128 BASIC

HB3
IP65

NEW



130 BASIC

HBL BEATRIX
IP65



132 PLUS

PANTH SL2
IP65



134 PRO

HB2 PRO
IP65

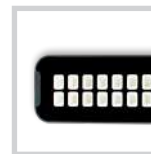

130 PRO

HBL BEATRIX
IP65

FLOODLIGHT PROJECTORS

NEW



136 PLUS

PANTH ST
IP65



140 PLUS

PANTH EVO
IP65



142 PLUS

PANTH EVO
PIR SENSOR
IP44



132 PLUS

PANTH SL2
IP65

Outdoor

144

FACADE PROJECTORS

NEW



146 PRO

MINILINI
IP65



150 PRO

JAZZ
IP65

PROJECTORS



152 BASIC

SPIKE LED
IP67



154 PLUS

UNDERWATER
PROJECTORS
SUBAQ
IP68



156 PLUS

INGROUND
WALK-ON FITTING
IP67

NEW



111 PLUS

DURABLE
WALKABLE IP65

DECORATIVE FIXTURES



158 BASIC

PLAFO T2
IP40



160 BASIC/PRO

BULKHEAD
T&O - IP65



163 BASIC

SEGNASENTIERO
IP65



164 BASIC

ZOE
IP54

DRIVER AND CONTROLLERS

166



167



173

3F Filippi

TARGETTI

DURA
LAMP

Since 1952, 3F Filippi S.p.A has been a benchmark in the field of efficient technical lighting fixture design and manufacturing.

The products, which are designed and created exclusively in the Pian di Macina - Pianoro (Bologna) facilities, are an expression of the company's ability to combine the traditional and the modern, craftsmanship and technology, appearance and functionality, and efficiency and sustainability.



Targetti has been designing and producing indoor and outdoor architectural lighting fixtures since 1928.

For over ninety years, its products have been illuminating prized artistic and architectural works throughout the world and are the expression of innovation, research, and attention to detail.

The company has always placed its experience and expertise at the disposal of architects, designers, and professionals in the lighting world.



With decades of experience and solid technical skill, Duralamp offers a wide range of high quality and efficient products.

Thanks to its expertise, it selects the latest generation components, engineering reliable products, with an offer that includes sources, LED strips, and lighting fixtures.



An Italian company open to the world

Founded in Florence at the beginning of the 1980s as the Luminous Springs division of Targetti Sankey s.p.a., in 1982 Duralamp became independent and began to develop in the manner most congenial to it, with an emphasis on product engineering and the improvement of technologies and production processes.

The implementation of these processes and methodologies took shape at the beginning of the 2000s, on the one hand with the acquisition, in Joint-Venture, of a production site in China, and on the other hand with the development of reliable and long-lasting partnerships with other leading production realities both in Europe and in the East.

Duralamp is part of the 3F Filippi Group | TARGETTI. The recent acquisition by 3F Filippi has made it possible to develop synergies of great interest, and allowed the Group to structure an extremely varied product portfolio. The breadth of range, production capacity and customer response has now multiplied and is able to meet both the needs of Electrical Equipment Distribution and those of Specifiers and Buyers, Architects and Lighting Designers, at a global level.





Mission and Vision

We believe that by providing the best products at the best prices it is possible to build a relationship of trust with customers that lasts over time.

Why do we believe we can do it? Because restructuring Standardised commodity products and finding the right balance of quality or even 'forging' light to meet the particular needs of an installation to us is a source of great professional satisfaction that turns into customer service.

In a wider Vision we work to make a positive impact on people's lives with lighting environments that have never been seen before in terms of quality and usability. While paying attention to containing both design and production costs, we are committed to using cutting-edge technology to create a new dimension of light quality and control to place users at the centre of their choices.



Technological evolution

The entire world of mass produced “light fixtures” has changed: today the request is for “lighting solutions” that are differentiated according to uses and areas of application. Duralamp is able to provide both a range of retrofitting fixtures and commodity lighting fixtures (Panels, Led, Hi Bay, Batten, Projectors etc.) as well as LED strips and power supply systems and intelligent control systems (Smart Building). Our product improvements are dedicated to making a difference to the lifespan, emission stability over time and full compliance with requested parameters: they may not be visible but it is their effectiveness that interests us. In a world in continuous evolution we manage to maintain control over production and the choice of components to produce products with a quality/price ratio that can meet the different needs of the market.

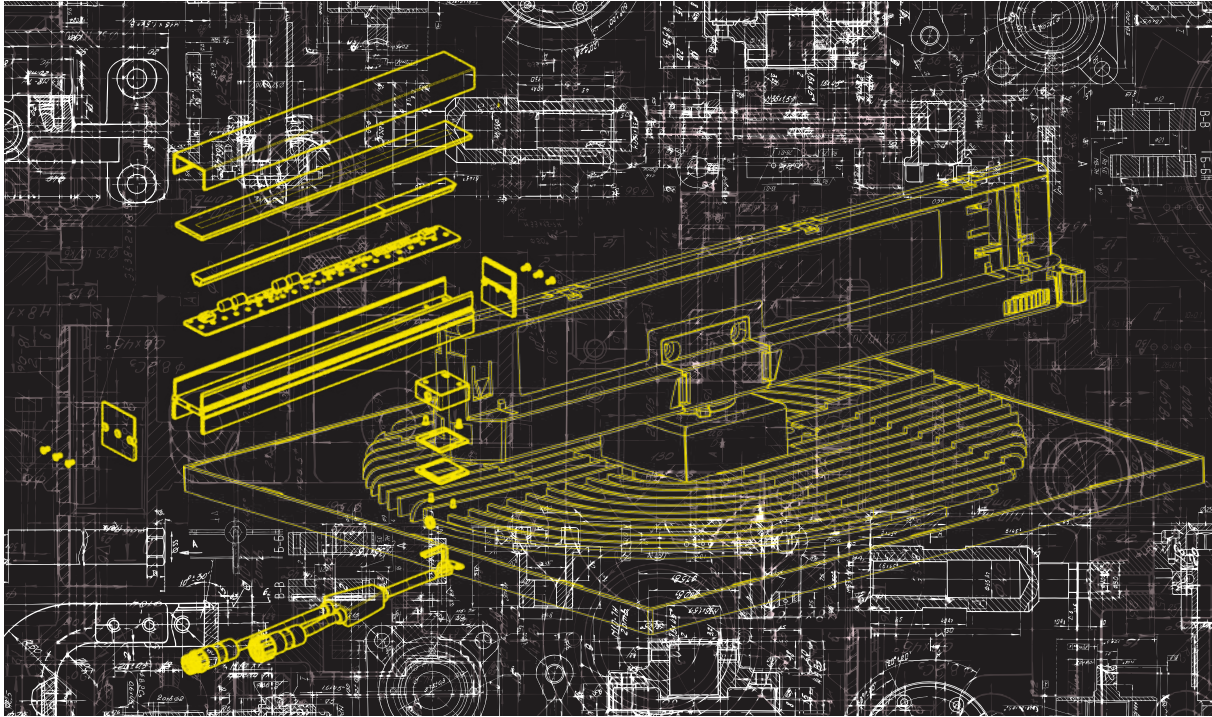



Custom-made products

The majority of products distributed worldwide are those that appear in catalogues that are differentiated according to reference markets. Yet it is custom-made products that give us the most satisfaction and allow us to put into practice all our expertise and technical ability... To satisfy particular requests from specifiers, lighting designers and architects we are able to provide 'custom-made' products, engineered, designed and built with the care a tailor puts into a made to measure shirt...

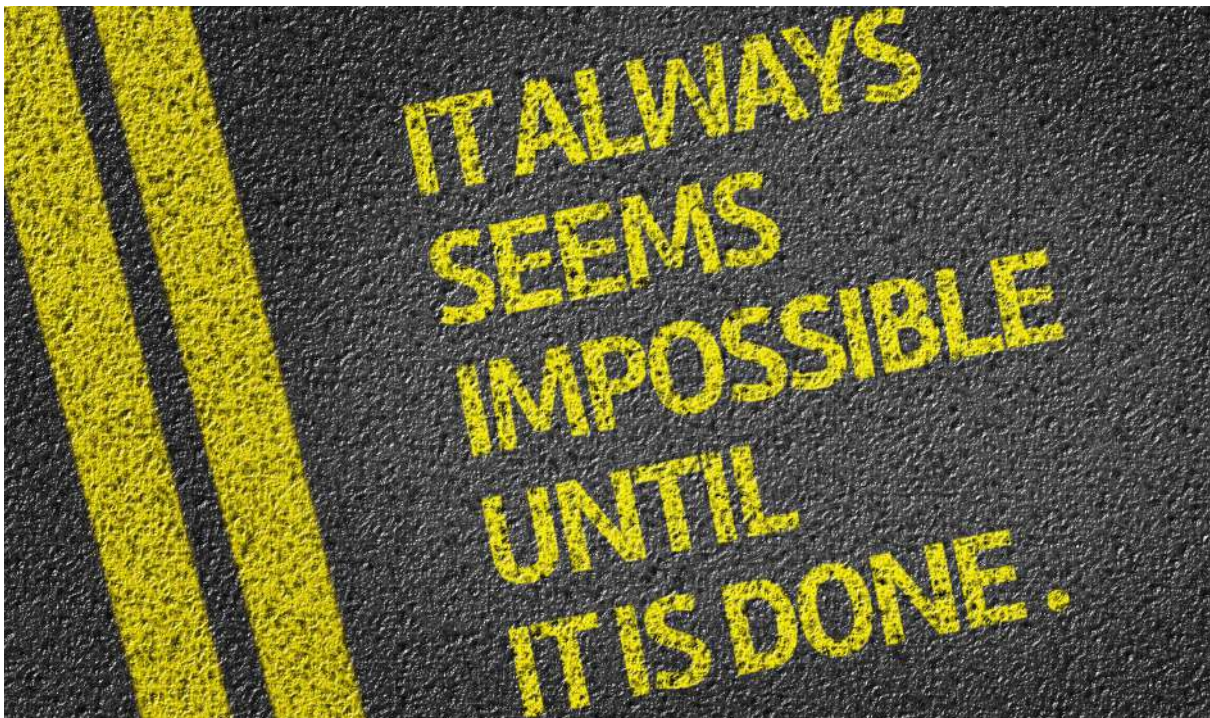

Where can you find us?

In many areas Duralamp is present with direct sales representatives able to propose solutions and provide technical support for the choices made by Specifiers. The company can also rely on a network of Distributors who manage their respective local markets with stock and pre-sales and after-sales services. This extensive and varied commercial network is a real asset that complements the international structure of the various branches in the Group. The network Duralamp operates through is really extensive and allows them to participate actively and effectively in projects in different countries around the world, in Europe, the USA, South America and the Far East.



More details on www.duralamp.it



Why choose Duralamp

Duralamp has a great advantage: a streamlined and flexible structure ready to study technology to improve existing solutions or discover new ones. Four decades of first-hand experience in production sites in China, an onsite engineering team, constant research into the most suitable materials, the most effective industrial processes, monitoring and controlling all production processes and cutting edge technology in our production sites both in Italy and abroad... all allow us to provide the expertise that has allowed us to successfully conclude high-level projects around the world. Of course in addition to daily operations that are subject to ISO 9001 Certification Quality Standards.



All Duralamp products conform to all European Directives and where required have obtained Quality and Safety marks from other countries:



SIMPLY LOADED WITH INFORMATION



We have built a site with a **simple and intuitive structure**: to find the **information you are looking for immediately!**

Discover the tools that customers, specifiers, lighting designers and the worldwide sales network need to be convincing and successful in the way that suits us best: **with fairness and transparency.**

the website and datasheets are available in **English, French, Spanish and German***.

not only news but also product insights

OUR identity

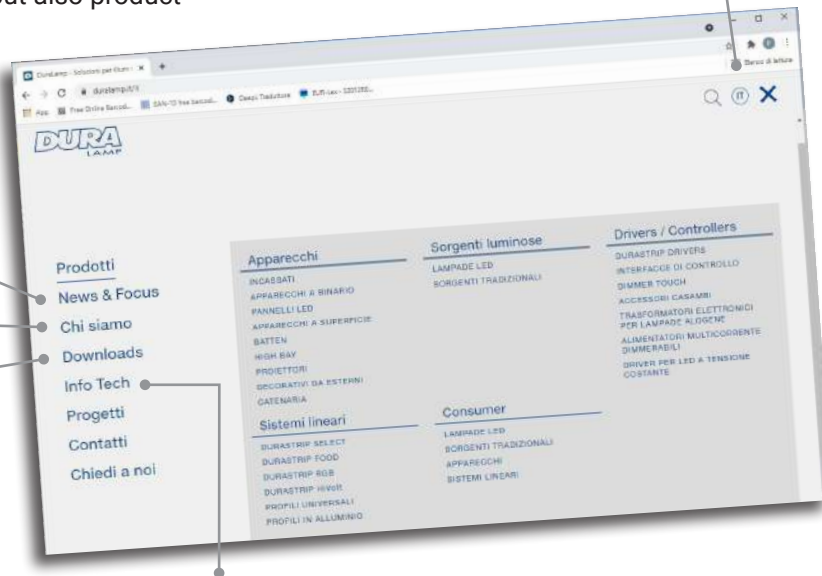

Catalogue and website icons

Scientific explanations on the colour of light and its codings

- Fotometrie
- EuLumDat
- Schemi controller per DURASTRIP
- Legenda
- Approfondimento tecnico
- Dati colorimetrici
- Attacchi
- Garanzia LED
- Certificazioni
- Sistema di qualità
- Conformità alla Direttiva RoHS
- ECO RAEE
- Mercurio

direct access to the collection of all available photometric files interesting insights

interesting insights

warranty specifications for LED products

Product certifications
Duralamp Quality Certifications

RoHS compliance

The consortium in charge of of which we are a member

How to dispose of lamps containing mercury...

responsive' site: perfect usability even from mobile phones



* the pages photographed here are in Italian for typographical reasons only.

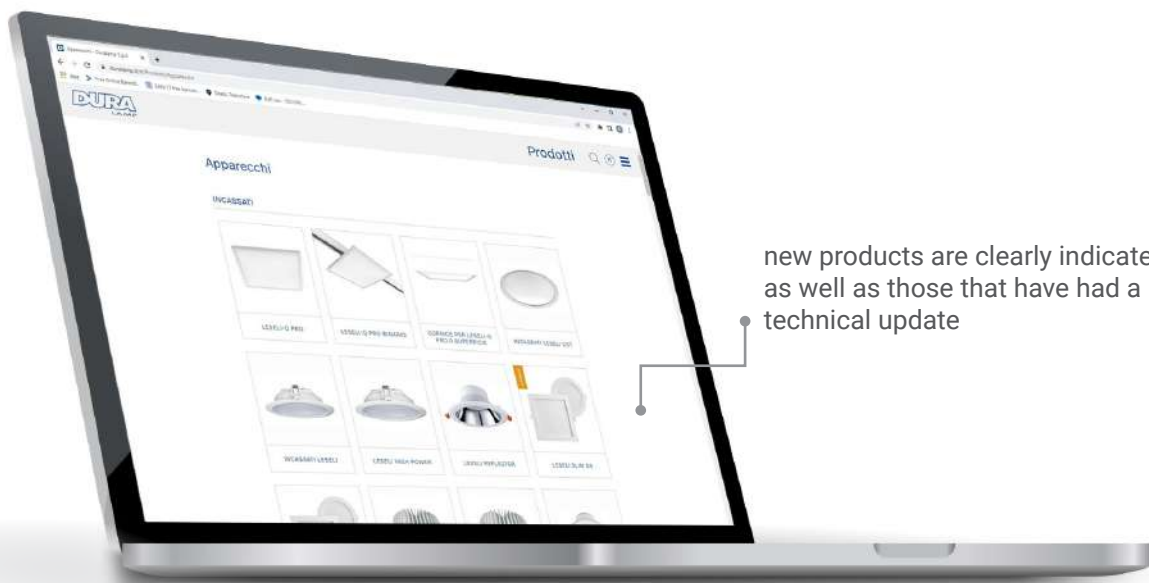

new products are clearly indicated,
as well as those that have had a
technical update

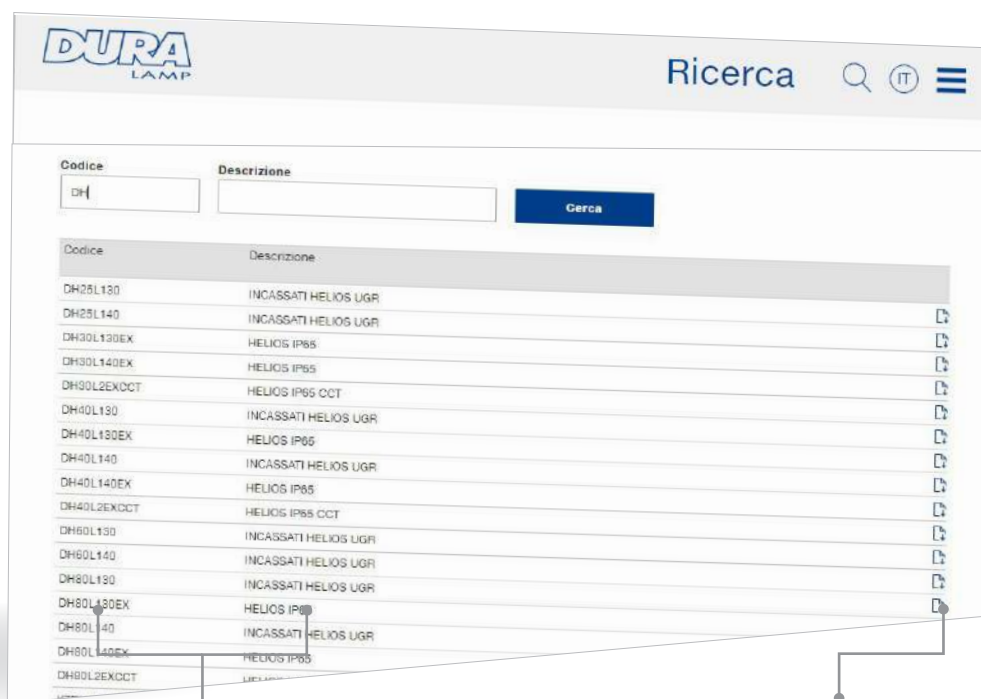

click on the code or the
description to enter the
product page

click on the file icon to
download the data sheet
directly.

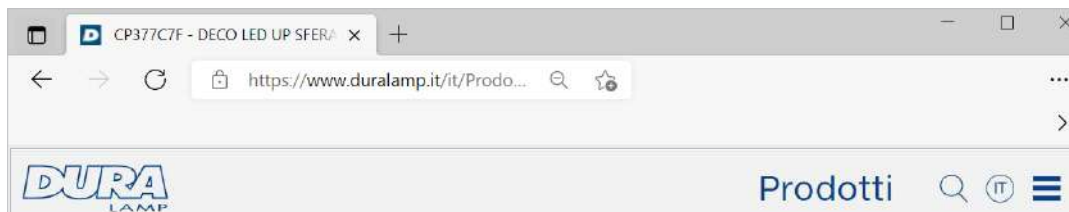

INCASSATO MULTIOTTICA

Apparecchi | INCASSATI

Condividi

Richiedi info

Ask the company for information

Allows you to send the page to someone as a link, therefore weightless, also to their e-mail as a reminder

Tipologia

Apparecchio da incasso rettangolare per due lampade orientabili con attacco GU10.

Caratteristico

Ampliamente utilizzato nelle installazioni del settore retail, soddisfa le esigenze di chi preferisce un apparecchio da incasso a soffitto per lampade sostituibili. Offre il vantaggio della multidirezionalità e dell'orientabilità del fascio luminoso da +15° a -15° sul piano verticale. Alloggia lampade PAR16; compatibile con tutte le lampade GU10 del catalogo Duralamp. Max 30 W.

Installazione

Ad incasso con le apposite molle in alluminio zincato. Completo di portalamпада GU10.

Materiale

Corpo in alluminio verniciato nero con cornice color argento.

APPARECCHIO INCASSATO MULTIOTTICA



IP20 VI IP23 VO -25°C +45°C BASIC 05h24

L'apparecchio non include la lampada: scegliere la lampada più adatta dalla nostra gamma. Per un uso professionale suggeriamo gli articoli 26530LU/26540LL.

on the product page you will find the description and all technical data relating to that product type. An iconographic part allows you to have some info 'in sight' and then find the details further down.

Articolo	Montaggio	Connessione	Colore	IP	L	L1	H
ZKR2-ST			Grigio argento	20	107	210	125
ZKR2-STB NEW	Ad incasso	GU10	Grigio argento/nero	20	107		125



In the Download section you can download*:



- Product sheet
- Specification text in two formats
- Product images
- Eulumdat
- Instruction manual
- Energy label

Other Tech Info if needed for the product (e.g. dimmer switch that can be used etc.)

*If available on the product



re-think^{4R}
Reduce
Re-use
Recycle

Green Quest - a journey towards environmentally friendly methods and processes

A 'green' mindset cannot be improvised.

At Duralamp, we have been working every day for decades to make our products ALWAYS MORE EFFICIENT, for real energy savings that can be seen from the very first days of use.

Energy saving is a fundamental point, but equally important are optimisations aimed at limiting the consumption of non-renewable raw materials. The right balance between product quality and the careful choice of raw materials, the weight and consistency of plastic materials where irreplaceable, the rationalisation of work processes aimed at reducing consumption in production, improving the environment and the lives of people working. Greater efficiency at all stages of processing to reduce the energy consumption needed to obtain the same result while avoiding waste: we are constantly working in this direction.

A battle fought chip by chip and shipment by shipment to improve the environment in which we all live.

Because the future is now.

We have chosen.



to engage at various levels:

- Corporate**
 - Optimization achieved thanks to the new Group Data Centre
 - Use of paper from FCC Forests for catalogue printing
 - Separate collection at all levels, recycling and reuse wherever possible: the pillars of the green economy!
- Product**
 - Use of recyclable raw materials: commitment to increase their up to 90% of the components.
 - Packaging made from 70% recycled paper.
 - External packaging from FSC forests.
 - Study of products that go beyond the concept of disposable equipment, returning to a wise concept of equipment to be reused, to reduce the consumption of materials and allow the use of products over time.

we have also chosen to act on...

packaging. Packaging is one of the highest volume of 'wasted' materials, and therefore a commitment, for municipalities around the world.

The ECO packaging programme of Duralamp has:

- ✓ totally eliminated plastic film on pallets in favour of  recyclable film
- ✓ replaced plastic adhesive tape in favour of  paper tape
- ✓ eliminated plastic protection pads in favour of recycled paper  recycled paper filling material



* Polystyrene and PVC fillers have been phased out, with rare exceptions.

We have chosen...

to 'rethink' how we produce our products. The right direction is to have more and more items built for long life use, that can be used again and again, and again...



RETHINK

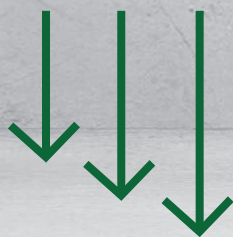

REDUCE



REUSE



RECYCLE

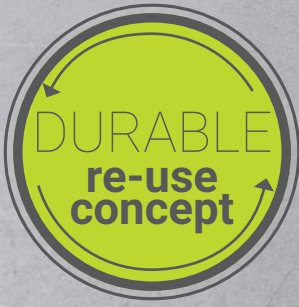

Replaceable lamp luminaires are

**perfect for re-use and
reduces the amount of
materials needing to
be disposed of**

Previously unimagined lumen/watt
efficiencies allow lamps to

**significantly reduce
energy consumption**



Highly popular Lamp Sources and Professional
Fixtures with exceptionally long service lives
means

**investing in technology
for the benefit of the
ecosystem**



DURALAMP and the GREEN packaging revolution:

**DURALAMP contributes to a cleaner world ...
while ensuring safer shipments.**

Together with a leading company specialized in paper packaging, we studied some packaging solutions that guarantees a safer shipments of our products, while pursuing our desire to actively contribute to the elimination of plastic materials in favor of recyclables.

The 120x80 pallets packaging includes a high cardboard box, SUPERBOX, with central loading; a 'hood' in compostable material* to replace the shrink plastic film, and a strap, instead of the plastic adhesive tape.

With this new palletization, products with a height of up to 170 cm (e.g. tubes) will be shipped vertically, fully protected inside a package complete with a robust closing cap. To better protect shipments, 'no overlapping triangles' will be placed on all pallets less than 2 meters high to prevent other goods to be stocked on top and risking to damage our products.

SUPERBOX: The standard height is 1 meter but there are many packaging options...

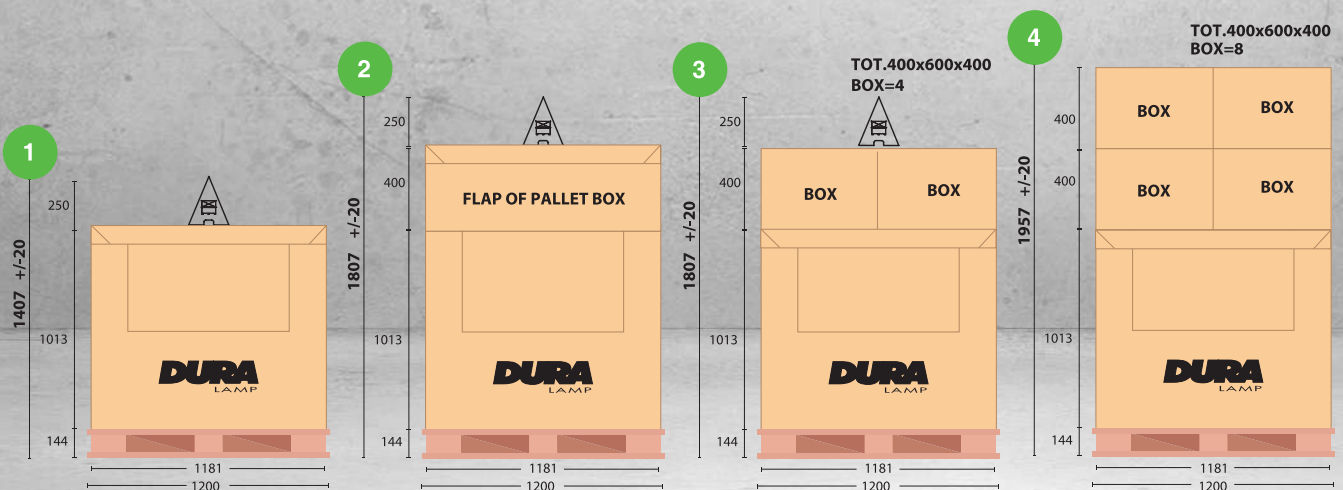

protective cap made of compostable and biodegradable material*: replaced heat-shrinkable plastic film saving kilometres of plastic per year

'no overlapping triangles' will be placed on all pallets less than 2 meters high to prevent other goods to be stocked on top and risking to damage our products.



compared to tape, straps are less in quantity and allow correct paper recycling

recycled pallets

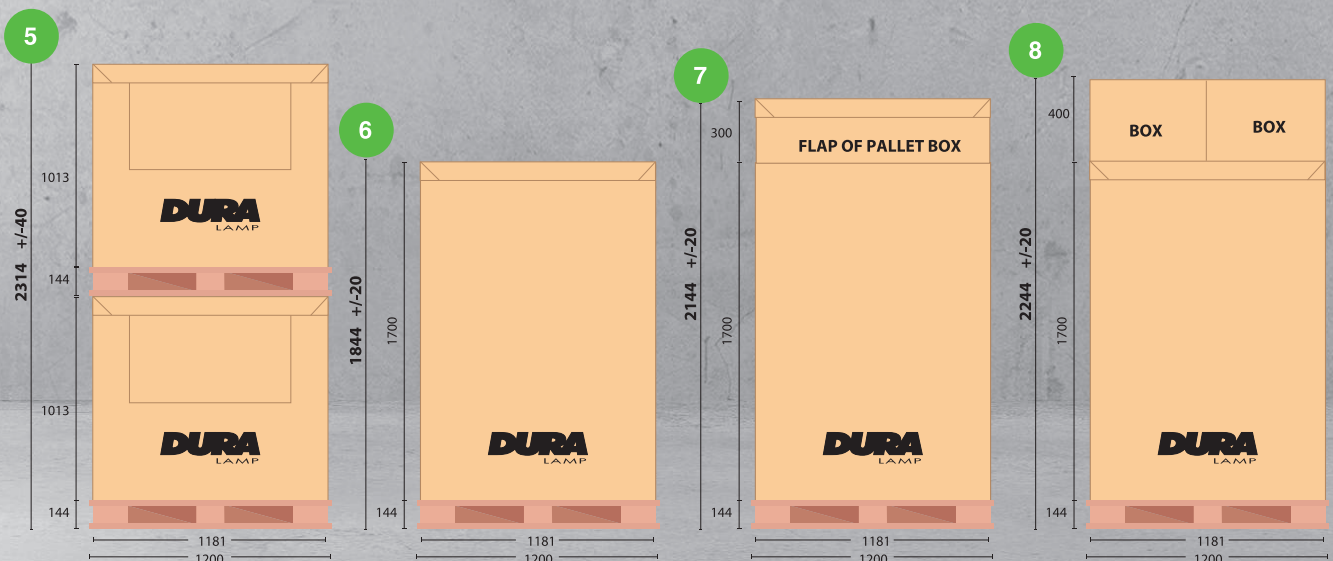
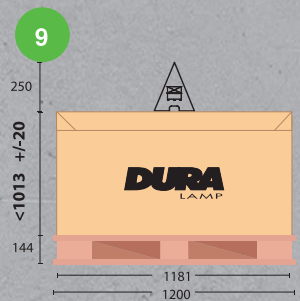

* Compliant with EN13432 with OK COMPOST certificate n. TA8011400928, issued by TUV Austria on 13/08/2018.



LED TABLE LAMP

NEW



PLUS
MARAMA

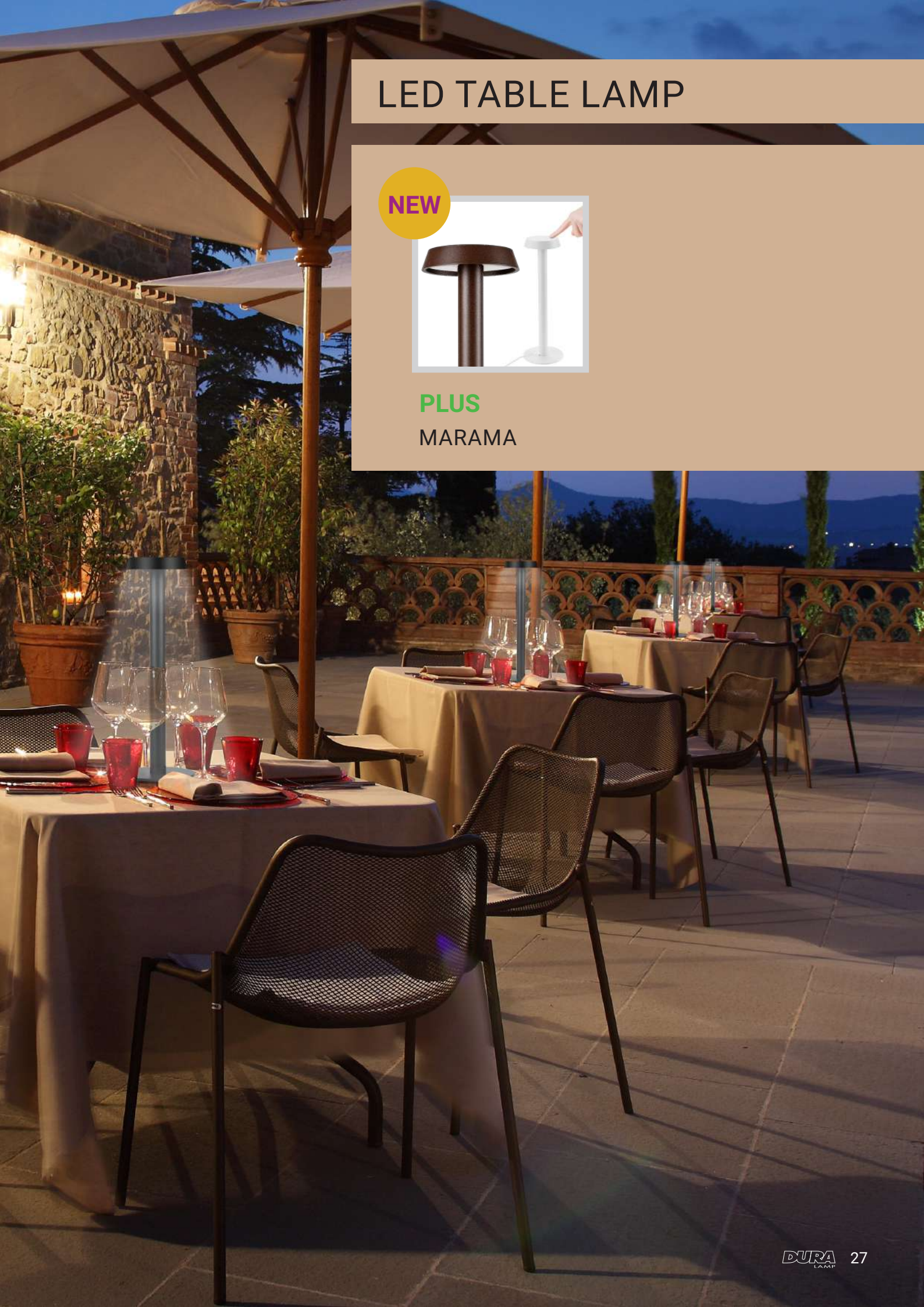

MARAMA



MARAMA

MARAMA

TYPE

LED table lamp, dimmable and cordless.
Elegant and essential design, perfect for both modern and classical settings.
Diffused light directed downwards.

CHARACTERISTICS

Marama is produced in three versions, all dimmable: warm colour temperature (3000K) and two options of changing the temperature of the light from warm to natural (2700K-4000K and 1800K-4000K).

Marama is operated by a touch on the top of the diffuser: the touch activates on/off and light intensity.

Models with a choice of colour temperature, the same 'touch' allows you to select the desired temperature.

Battery: battery life of up to 12 hours at full light output and up to 5 days at the lowest output.
Equipped with large capacity 6600mAh rechargeable lithium battery.
Charger USB C not included.
Battery charging time: 5~6 hours.

MATERIALS

Powder-coated aluminium; frosted polycarbonate screen.



PLUS	5V DC	Ra>90		50000h L70 B20	IP53	-25° +45°C		G3	Risk Group 0
------	-------	-------	--	----------------	------	------------	--	----	--------------

art.	W	K	Ø	Ø1	H			
New MAR13000DIMWH	2	3000	100	120	350	850		10
New MAR13000DIMCO	2	3000	100	120	350	850	988128	10
New MAR13000DIMBL	2	3000	100	120	350	850	988104	10
New MAR12740CCTWH	2	2700-4000	100	120	350	850	988135	10
New MAR11840CCTWH	2	1800-4000	100	120	350	850	988159	10
New MAR11840CCTBL	2	1800-4000	100	120	350	850	988166	10

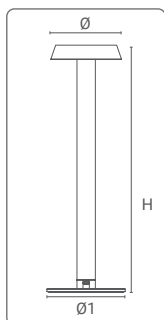

SEE MARAMA'S STORY



DOWNLIGHTS

THE FUNDAMENTALS

NEW



BASIC

LESELI SC

Diffuse lighting, 4 sizes, 3 light colours for each, 110° wide beam: a range that meets all requirements up to 2600 lumens of real output.

NEW



PRO

HELIOS UGR + FLOOD

The HELIOS UGR range, luminaires with recessed source: a wide choice in the UGR version. Two luminaires in one with the 80° lens option: one luminaire, several optical solutions.



PRACTICALITY OF MANAGEMENT



BASIC

LESELI
CCT

The choice of colour temperature from the driver - 3000K / 4000K / 6000K - allows a significant reduction in stock! Also in IP65 PRO version.



PRO

HELIOS IP65
CCT

SPECIALISTS



PRO

HELIOS IP65



PRO

HELIOS IP65
CCT

An IP65 recessed luminaire in 3 sizes and wattages to meet different requirements, in both fixed and driver-selectable (CCT) colour temperature versions.

LOW THICKNESS



BASIC
LESELI DS
SLIM



BASIC
LESELI SLIM

NEW



PRO
RTF100

Low-thickness is the requirement? Multiple solutions: BASIC with LESELI SLIM DS, in round or square versions and LESELI SLIM with surface-mounted frames. PRO with the new RTF 100 range: finned aluminium body, choice of power in the two shapes, round and square, and long service life, 50,000h.

SPOT LED 2"

NEW



BASIC
VALO MINI

NEW





PRO
LESELI MINI PRO

Two ranges, BASIC and PRO, to meet 'cut hole' requirements: all adjustable, plus a dimmable option. Essential design that can be used anywhere as a replacement for the old MR16.

LOOKING FOR A DOWNLIGHT?

↓ ↓ Items ordered by cut hole size

	art.	W	lm	Kelvin		Info	Driver	Ra			Page
PRO	DH25L130	9	850	3000K	36°	UGR	E	>90	65		49
PRO	DH25L140	9	850	4000K	36°	UGR	E	>90	65		49
PRO	D306TWW	8	650	3000K	36°			>80	68		51
PRO	D306TNW	8	680	4000K	36°			>80	68		51
PRO	D306TNW-D	9	575	4000K	36°			>95	68		51
PRO	D306TWW-D	9	550	3000K	36°			>95	68		51
PRO	RTF03L130T	7	600	3000K	110°		E	>90	75		43
PRO	RTF03L140T	7	630	4000K	110°		E	>90	75		43
PRO	RTF03L160T	7	660	6500K	110°		E	>90	75		43
PRO	RTF03L130Q	7	630	3000K	110°		E	>90	75		43
PRO	RTF03L140Q	7	665	4000K	110°		E	>90		75x75	43
PRO	RTF03L160Q	7	700	6500K	110°		E	>90		75x75	43
PRO	DH30L130EX	7	590	3000K	90°	IP65	E	>90	85		47
PRO	DH30L140EX	7	590	4000K	90°	IP65	E	>90	85		47
PRO	DH30L2EXCCT	7	560	3/4/6000K	90°	IP65	E	>90	85		45
PRO	DH40L130	14	1450	3000K	36°	UGR	E	>90	100		49
PRO	DH40L140	14	1450	4000K	36°	UGR	E	>90	100		49
PRO	RTF04L130T	14	1195	3000K	110°		E	>90	120		43
PRO	RTF04L140T	14	1260	4000K	110°		E	>90	120		43
PRO	RTF04L160T	14	1325	6500K	110°		E	>90	120		43
PRO	RTF04L130Q	14	1260	3000K	110°		E	>90		120x120	43
PRO	RTF04L140Q	14	1325	4000K	110°		E	>90		120x120	43
PRO	RTF04L160Q	14	1390	6500K	110°		E	>90		120x120	43
PRO	DH40L130EX	12	960	3000K	90°	IP65	E	>90	125		47
PRO	DH40L140EX	12	960	4000K	90°	IP65	E	>90	125		47
PRO	DH40L2EXCCT	12	960	3/4/6000K	90°	IP65	E	>90	125		45
PRO	DH60L130	28	2800	3/4000K	36°	UGR	E	>90	150		49
PRO	DH60L140	28	2800	4000K	36°	UGR	E	>90	150		49
PRO	RTF08L130T	24	2185	3000K	110°		E	>90	195		43
PRO	RTF08L140T	24	2300	4000K	110°		E	>90	195		43
PRO	RTF08L160T	24	2415	6500K	110°		E	>90	195		43
PRO	RTF08L130Q	24	2185	3000K	110°		E	>90		195x195	43
PRO	RTF08L140Q	24	2300	4000K	110°		E	>90		195x195	43
PRO	RTF08L160Q	24	2415	6500K	110°		E	>90		195x195	43
PRO	DH80L130	37	3700	3000K	36°	UGR	E	>90	200		49
PRO	DH80L140	37	3700	4000K	36°	UGR	E	>90	200		49
PRO	DH80L130EX	40	3200	3000K	90°	IP65	E	>90	210		47
PRO	DH80L140EX	40	3200	4000K	90°	IP65	E	>90	210		47
PRO	DH80L2EXCCT	40	3200	3/4/6000K	90°	IP65	E	>90	210		45

↓ ↓ Items ordered by cut hole size

	art.	W	lm	Kelvin		Info	Driver	Ra			Page
BASIC	VA03L130T	7	620	3000K	40°			>80	72		50
BASIC	VA03L140T	7	650	4000K	40°			>80	72		50
BASIC	DT30L130	6	450	3000K	110°			>80	75		35
BASIC	DT30L140	6	470	4000K	110°			>80	75		35
BASIC	DT30L160	6	470	6000K	110°			>80	75		35
BASIC	VA03L130Q	7	620	3000K	40°			>80		75x75	50
BASIC	VA03L140Q	7	650	4000K	40°			>80		75x75	50
BASIC	DS04L130T	6	310	3000K	120°		E	>80	105		39
BASIC	DS04L140T	6	330	4000K	120°		E	>80	105		39
BASIC	DS04L160T	6	350	6000K	120°		E	>80	105		39
BASIC	D41540SL2	6	420	4000K	120°		E	>80	113		41
BASIC	DS04L130Q	6	310	3000K	120°		E	>80		105x105	39
BASIC	DS04L140Q	6	330	4000K	120°		E	>80		105x105	39
BASIC	DS04L160Q	6	350	6000K	120°		E	>80		105x105	39
BASIC	D41540QSL2	6	420	4000K	120°		E	>80		114x109	41
BASIC	DT40L1CCT	12	1200	3/4/6000K	110°		E	>80	125		37
BASIC	DT40L130	12	1000	3000K	110°			>80	150		35
BASIC	DT40L140	12	1050	4000K	110°			>80	150		35
BASIC	DT40L160	12	1050	6000K	110°			>80	150		35
BASIC	D82540QSL2	18	1400	4000K	120°		E	>80		188x193	41
BASIC	DT80L130	22	2000	3000K	110°			>80	195		35
BASIC	DT80L140	22	2050	4000K	110°			>80	195		35
BASIC	DT80L160	22	2050	6000K	110°			>80	195		35
BASIC	DT80L1HP30	30	2600	3000K	110°		E	>80	195		35
BASIC	DT80L1HP40	30	2600	4000K	110°		E	>80	195		35
BASIC	DT80L1HP60	30	2050	6000K	110°		E	>80	195		35
BASIC	DT80L1CCT	22	2200	3/4/6000K	110°		E	>80	200		37
BASIC	DT80L1CCTHP	30	3000	3/4/6000K	110°		E	>80	200		37
BASIC	DS08L130T	18	1230	3000K	120°		E	>80	203		39
BASIC	DS08L140T	18	1300	4000K	120°		E	>80	203		39
BASIC	DS08L160T	18	1360	6000K	120°		E	>80	203		39
BASIC	DS08L130Q	18	1230	3000K	120°		E	>80		203x203	39
BASIC	DS08L140Q	18	1300	4000K	120°		E	>80		203x203	39
BASIC	DS08L160Q	18	1360	6000K	120°		E	>80		203x203	39
BASIC	D41540SL2	6	420	4000K	120°		E	>80	208		41
BASIC	D82540SL2	18	1400	4000K	120°		E	>80	208		41
BASIC	DS10L130Q	24	1710	3000K	120°		E	>80		277x277	39
BASIC	DS10L140Q	24	1800	4000K	120°		E	>80		277x277	39
BASIC	DS10L160Q	24	1890	6000K	120°		E	>80		277x277	39
BASIC	DS10L130T	24	1710	3000K	120°		E	>80	280		39
BASIC	DS10L140T	24	1800	4000K	120°		E	>80	280		39
BASIC	DS10L160T	24	1890	6000K	120°		E	>80	280		39

E = remote driver

LESELI DOWNLIGHT SC

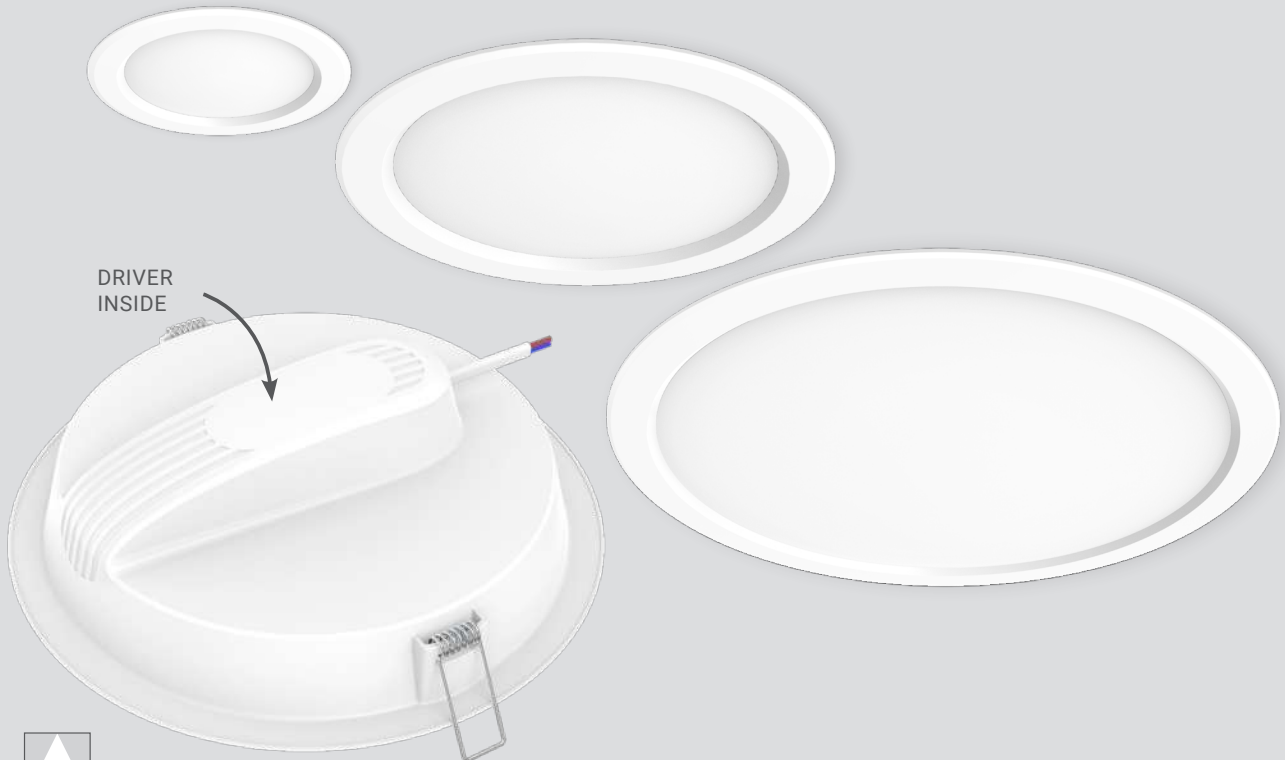

110°



6W

Ø75mm



12W

Ø150mm



22W/30W

Ø195mm

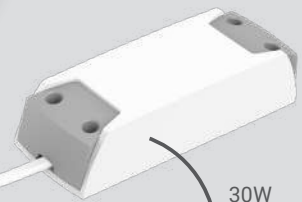

30W

DRIVER
OUTSIDE
DT80L1HP

REAL LUMENS

Luminous Flux Data is REAL. Values are measured on actual use conditions. Nominal values of the LED source are not stated.

LESELI DOWNLIGHT SC

TYPE

LED source with SMD technology and high efficiency chip integrated into a recessed luminaire.

CHARACTERISTICS

Soft satin effect polycarbonate anti-glare diffuser.
Flicker Free.

MOUNTING

Complete with springs for easy fastening into false ceilings. Cable (1 m) with IP65 quick connector.





MATERIALS

Thermally conductive body; extremely light and manageable.

**FLICKER
FREE** 

Providing greater visual comfort, improved definition of detail and reduction of stress.

BASIC	220-240V 50/60Hz	Ra>80		25000h L70 B20	IP20 VI IP43 VO		-25° +35°C		G3	Risk Group 1
-------	---------------------	-------	---	-------------------	--------------------	---	---------------	---	----	-----------------

	art.	W	lm	cd	K	PF		Ø	H			 8011905	
New	DT30L130	6	455	160	3000	0,8	110°	92	50	75	52	985912	40
New	DT30L140	6	470	165	4000	0,8	110°	92	50	75	52	985905	40
New	DT30L160	6	470	165	6000	0,8	110°	92	50	75	52	985899	40
New	DT40L130	12	1000	350	3000	0,9	110°	166	54	150	129	984328	20
New	DT40L140	12	1050	365	4000	0,9	110°	166	54	150	129	984335	20
New	DT40L160	12	1050	365	6000	0,9	110°	166	54	150	129	984342	20
New	DT80L130	22	2000	700	3000	0,9	110°	216	58	195	258	984359	10
New	DT80L140	22	2050	715	4000	0,9	110°	216	58	195	258	984366	10
New	DT80L160	22	2050	715	6000	0,9	110°	216	58	195	258	984373	10
New	DT80L1HP30	30	2600	910	3000	0,9	110°	216	58	195	342	984465	10
New	DT80L1HP40	30	2600	910	4000	0,9	110°	216	58	195	342	984403	10
New	DT80L1HP60	30	2600	910	6000	0,9	110°	216	58	195	342	984410	10

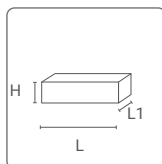
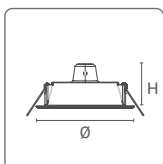

DRIVER DT80L1HP:

L= 124 mm
L1= 45 mm
H= 30 mm

For photometries please consult the website.

LESELI DOWNLIGHT CCT



110°



12W

Ø125mm



22W/30W

Ø200mm

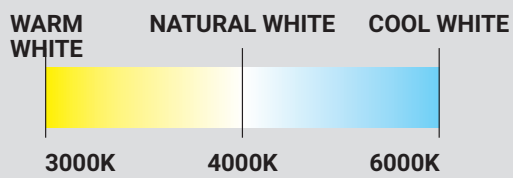

SWITCH

REAL LUMENS

Luminous Flux Data is REAL. Values are measured on actual use conditions. Nominal values of the LED source are not stated.

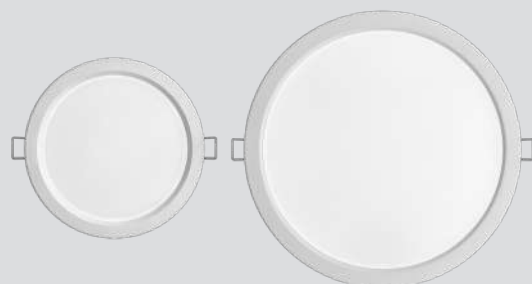

Ø 140 MM

Ø 216MM

LESELI DOWNLIGHT CCT

TYPE

LED source with SMD technology and high efficiency chip integrated into a recessed luminaire. Luminaire with facility to select the colour temperature on installation.

CHARACTERISTICS

Soft satin effect polycarbonate anti-glare diffuser.

Remote power supply equipped with a dip-switch to select the colour temperature. Flicker Free.

MOUNTING

Complete with springs for easy fastening into false ceilings. Cable (1 m) with IP65 quick connector.

MATERIALS

Thermally conductive body, extremely light and manageable.

**FLICKER
FREE**

Providing greater visual comfort, improved definition of detail and reduction of stress.

BASIC	220-240V 50/60Hz	Ra>80		25000h L70 B20	IP20 VI IP43 VO		-25° +35°C		G3	Risk Group 1
-------	---------------------	-------	--	-------------------	--------------------	--	---------------	--	----	-----------------

art.	W	lm	cd	K	PF		Ø	H				8011905	
DT40L1CCT *	12	1200 ⁽¹⁾	430	3000-4000-6000	0,5	110°	140	54	125	96	955441	30	
DT80L1CCT *	22	2200 ⁽¹⁾	770	3000-4000-6000	0,5	110°	216	58	200	214	953133	10	
DT80L1CCTHP *	30	3000 ⁽¹⁾	1050	3000-4000-6000	0,9	110°	216	58	200	214	953126	10	

* To be discontinued

⁽¹⁾The lumen and power data indicated refers to the 4000K colour temperature.

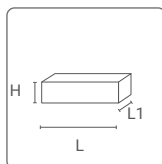
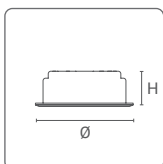

DRIVER:
L= 97.9 mm
L1= 45 mm
H= 24 mm

For photometries please consult the website.

LESELI SLIM DS



120°



6W

Ø105mm



18W

Ø203mm



24W

Ø280mm

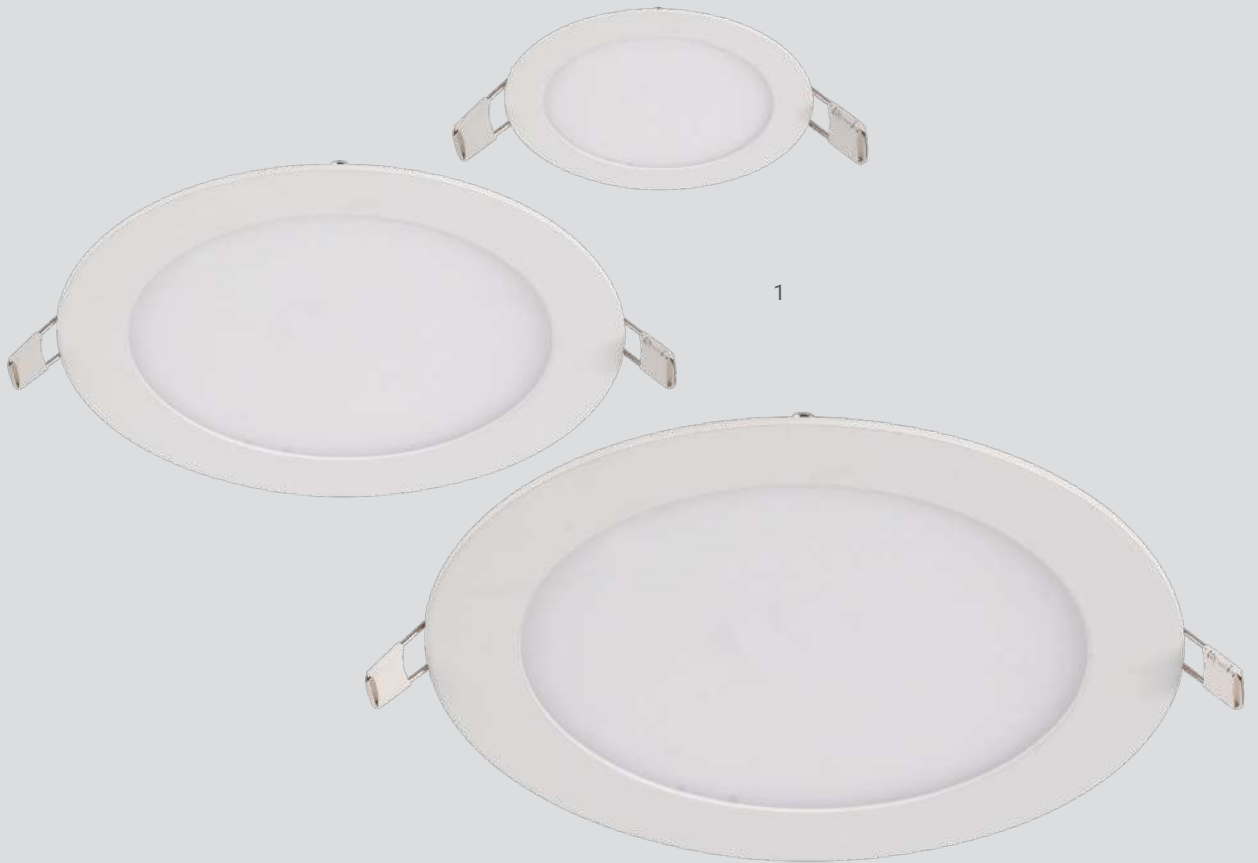

6W

105x105mm



18W

203x203mm



24W

277x277mm

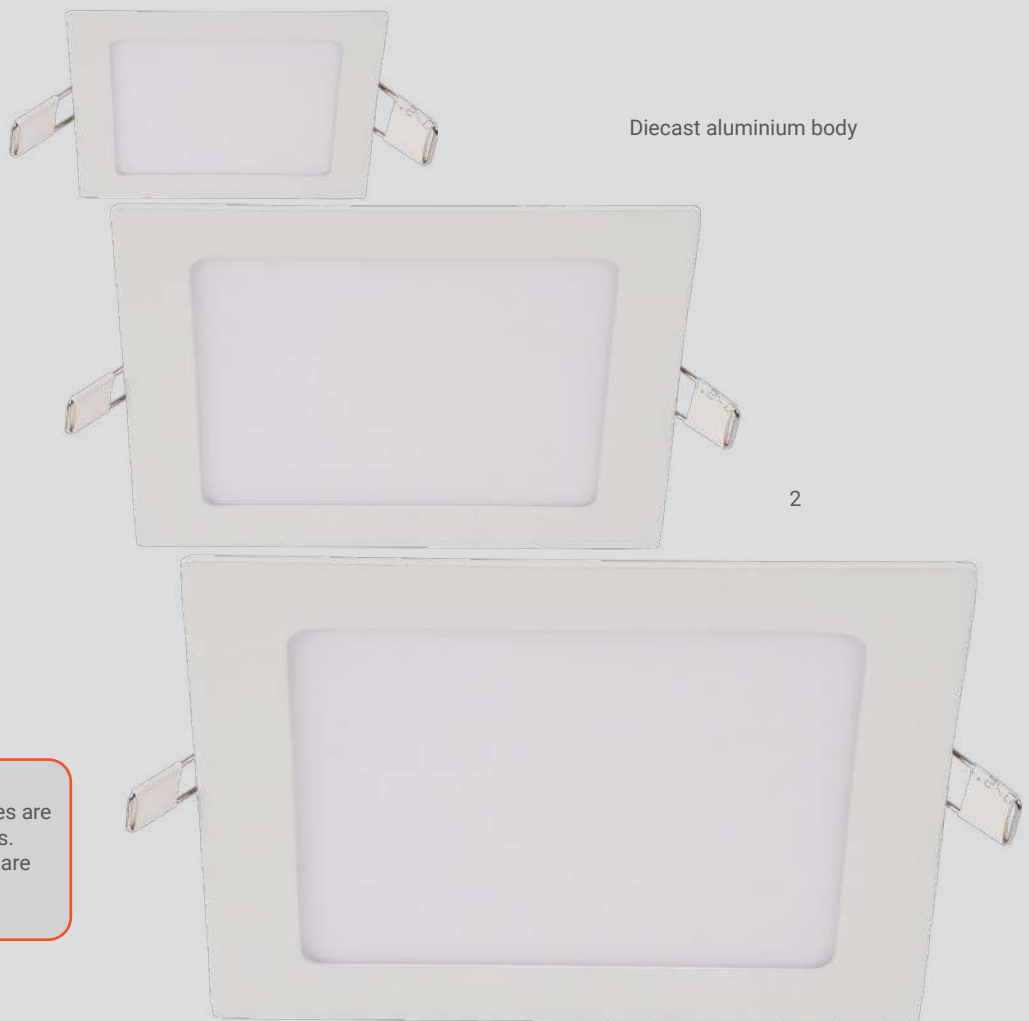

REAL LUMENS

Luminous Flux Data is REAL. Values are measured on actual use conditions. Nominal values of the LED source are not stated.

LESELI SLIM DS

TYPE

Ultra slim LED downlights with SMD technology and a high-efficiency chip.

CHARACTERISTICS

Downlights with extremely limited width and remote driver.

MOUNTING

Complete with springs for easy fastening into false ceilings. Surface/ceiling mounting options available with frame accessories.

MATERIALS

High dissipation die-cast aluminum body with anti-yellowing PC screen. Extremely lightweight for use in any false ceilings.



FLICKER FREE

Providing greater visual comfort, improved definition of detail and reduction of stress.

BASIC	220-240V 50/60Hz	Ra>80		15000h L70 B20	IP20 VI IP43 VO		-25° +35°C		G2	Risk Group 0
-------	---------------------	-------	--	-------------------	--------------------	--	---------------	--	----	-----------------

art.	Photo	W	lm	cd	K	PF		∅	H				8011905	
DS04L130T	1	6	310	88	3000	0,5	120°	120	8,5	105	110		954871	40
DS04L140T	1	6	330	93	4000	0,5	120°	120	8,5	105	110		954888	40
DS04L160T	1	6	350	99	6000	0,5	120°	120	8,5	105	110		954895	40
DS08L130T	1	18	1230	340	3000	0,5	120°	225	8,5	203	280		954901	20
DS08L140T	1	18	1300	360	4000	0,5	120°	225	8,5	203	280		954918	20
DS08L160T	1	18	1360	378	6000	0,5	120°	225	8,5	203	280		954925	20
DS10L130T	1	24	1710	475	3000	0,5	120°	295	8,5	280	480		954932	10
DS10L140T	1	24	1800	500	4000	0,5	120°	295	8,5	280	480		954949	10
DS10L160T	1	24	1890	525	6000	0,5	120°	295	8,5	280	480		954956	10

art.	Photo	W	lm	cd	K	PF		L	L1	H				8011905	
DS04L130Q	2	6	310	88	3000	0,5	120°	120	120	8,5	105x105	130		954963	40
DS04L140Q	2	6	330	93	4000	0,5	120°	120	120	8,5	105x105	130		954970	40
DS04L160Q	2	6	350	99	6000	0,5	120°	120	120	8,5	105x105	130		954987	40
DS08L130Q	2	18	1230	340	3000	0,5	120°	225	225	8,5	203x203	340		954994	20
DS08L140Q	2	18	1300	360	4000	0,5	120°	225	225	8,5	203x203	340		955007	20
DS08L160Q	2	18	1360	378	6000	0,5	120°	225	225	8,5	203x203	340		955014	20
DS10L130Q	2	24	1710	475	3000	0,5	120°	290	290	8,5	277x277	610		955021	10
DS10L140Q	2	24	1800	500	4000	0,5	120°	290	290	8,5	277x277	610		955038	10
DS10L160Q	2	24	1890	525	6000	0,5	120°	290	290	8,5	277x277	610		955045	10

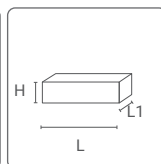
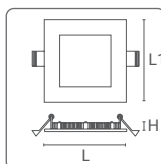
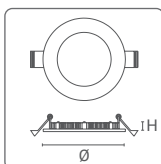

DRIVER 6W-18W:

L= 88 mm
L1= 38 mm
H= 22 mm

DRIVER 24W:

L= 99 mm
L1= 40 mm
H= 24 mm

For photometries please consult the website.

LESELI SLIM



6W
Ø113



18W
Ø208



6W
114x109mm



18W
188x183mm

ACCESSORIES FOR CEILING/SURFACE INSTALLATION



REAL LUMENS

Luminous Flux Data is REAL. Values are measured on actual use conditions. Nominal values of the LED source are not stated.

LESELI SLIM

TYPE

Ultra slim LED downlights with SMD technology and a high-efficiency chip.

CHARACTERISTICS

Downlights with extremely limited width and remote driver.

MOUNTING

Complete with springs for easy fastening into false ceilings. Surface/ceiling mounting options available with frame accessories.

MATERIALS

Heat resistant plastic with high dissipation body. Extremely lightweight for use in any false ceilings.



BASIC	220-240V 50/60Hz	Ra>80		25000h L70 B20	IP20 VI IP43 VO		-25° +35°C		Risk Group 0
--------------	---------------------	-------	--	-------------------	--------------------	--	---------------	--	-----------------



art.	W	lm	cd	K	PF		∅	H				
D41540SL2 *	6	420	120	4000	0,52	120°	128	26	113	128	860912	10
D82540SL2 *	18	1400	390	4000	0,52	120°	228	26	208	290	860936	10

* To be discontinued



art.	W	lm	cd	K	PF		L	L1	H				
D41540QSL2 *	6	420	120	4000	0,52	120°	128	128	26	114x109	140	860929	10
D82540QSL2 *	18	1400	390	4000	0,52	120°	202	202	26	188x183	300	860943	10

* To be discontinued



art		∅	h		
KTTSL2	Accessory for surface mounting	168	36	860967	1
KTT8SL2	Accessory for surface mounting	265	36	861544	1



art		L	h		
KTQSL2	Accessory for surface mounting Q128	168x168	36	860950	1
KTQ8SL2	Accessory for surface mounting Q202	242x242	36	861551	1

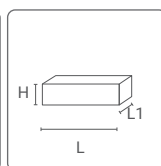
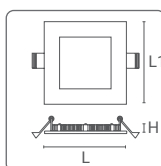
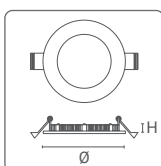

DRIVER:
L= 68 mm
L1= 34 mm
H= 22 mm

For photometries please consult the website.

RTF100



110°



7W

Ø75mm



14W

Ø120mm



24W

Ø195mm



1

Diecast aluminium body



7W

75x75mm



14W

120x120mm



24W

195x195mm



2



REAL LUMENS

Luminous Flux Data is REAL. Values are measured on actual use conditions. Nominal values of the LED source are not stated.

RTF100

TYPE

Ultra slim LED downlights with SMD technology and a high-efficiency chip.

CHARACTERISTICS

Downlights with extremely limited width and remote driver.

MOUNTING

Complete with springs for easy fastening into false ceilings.

MATERIALS

High dissipation die-cast aluminum body with anti-yellowing PC screen. Extremely lightweight for use in any false ceilings.



PRO	220-240V 50/60Hz	Ra>90		50000h L80 B20	IP20 VI IP43 VO		-25° +35°C		G5/ h24	Risk Group 0
-----	---------------------	-------	--	-------------------	--------------------	--	---------------	--	------------	-----------------

	art.	Photo	W	lm	cd	K	PF		∅	H				8011905	
New	RTF03L130T	1	7	600	290	3000	0,5	110°	100	24	75	130	987503	10	
New	RTF03L140T	1	7	630	305	4000	0,5	110°	100	24	75	130	987510	10	
New	RTF03L160T	1	7	660	320	6000	0,5	110°	100	24	75	130	987527	10	
New	RTF04L130T	1	14	1195	585	3000	0,5	110°	145	26	120	208	987534	10	
New	RTF04L140T	1	14	1260	615	4000	0,5	110°	145	26	120	208	987541	10	
New	RTF04L160T	1	14	1325	645	6000	0,5	110°	145	26	120	208	987558	10	
New	RTF08L130T	1	24	2185	965	3000	0,95	110°	225	35	195	423	987565	5	
New	RTF08L140T	1	24	2300	1015	4000	0,95	110°	225	35	195	423	987572	5	
New	RTF08L160T	1	24	2415	1065	6000	0,95	110°	225	35	195	423	987589	5	

	art.	Photo	W	lm	cd	K	PF		L	L1	H				8011905	
New	RTF03L130Q	2	7	630	310	3000	0,5	110°	100	100	24	75x75	141	987596	10	
New	RTF03L140Q	2	7	665	325	4000	0,5	110°	100	100	24	75x75	141	987602	10	
New	RTF03L160Q	2	7	700	340	6000	0,5	110°	100	100	24	75x75	141	987619	10	
New	RTF04L130Q	2	14	1260	615	3000	0,5	110°	145	145	26	120x120	226	987626	10	
New	RTF04L140Q	2	14	1325	645	4000	0,5	110°	145	145	26	120x120	226	987633	10	
New	RTF04L160Q	2	14	1390	675	6000	0,5	110°	145	145	26	120x120	226	987640	10	
New	RTF08L130Q	2	24	2185	965	3000	0,95	110°	225	225	26	195x195	550	987657	5	
New	RTF08L140Q	2	24	2300	1015	4000	0,95	110°	225	225	26	195x195	550	987664	5	
New	RTF08L160Q	2	24	2415	1065	6000	0,95	110°	225	225	26	195x195	550	987671	5	

DIMMABILITY: RTF100 can be used with multi-current dimming power supply, code DELT40D-M.
3 HOUR STANDBY LIGHTING. Can be used with Kit: KTEMRO3

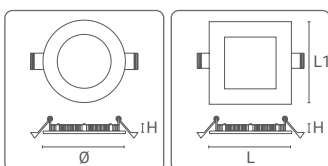

For photometries please consult the website.

HELIOS IP65 CCT



90°



7W

Ø85mm



12W

Ø125mm



40W

Ø210mm



Die-cast aluminium body

Remote driver

WARM WHITE NATURAL WHITE COOL WHITE

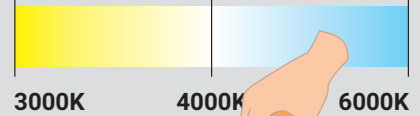

SWITCH

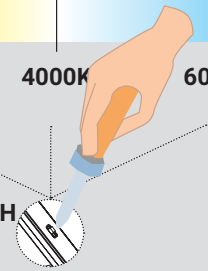

REAL LUMENS

Luminous Flux Data is REAL. Values are measured on actual use conditions. Nominal values of the LED source are not stated.

Ø 230MM
8"

Ø 140MM
4"

Ø 100MM
3"

HELIOS IP65 CCT

TYPE

High efficiency SMD LED sources LED source integrated in a Class III IP65 downlight fixture, Ra90, 50000 hours.

Remote power supply equipped with a dip-switch to select the colour temperature.

CHARACTERISTICS

IP65 fixture both optical/front side and the back/component side; IP20 remote driver included in the package. Remote power supply equipped with a dip-switch to select the colour temperature.

Flicker free.

MOUNTING

Complete with springs for easy fastening into false ceilings. Cable (1 m) with IP65 quick connector.

MATERIALS

Aluminium finned dissipation body.

FLICKER FREE

Providing greater visual comfort, improved definition of detail and reduction of stress.

PRO	220-240V 50/60Hz	Ra>90		50000h L70 B20	IP65		-25° +45°C		G5/ h24	Risk Group 1
-----	---------------------	-------	--	-------------------	------	--	---------------	--	------------	-----------------

art.	W	lm	cd	K	PF		Ø	H				8011905	
DH30L2EXCCT	7	560*	250	3000-4000-6000	0,55	90°	100	51	85	240	941260	36	
DH40L2EXCCT	12	960*	420	3000-4000-6000	0,55	90°	140	64	125	440	941277	27	
DH80L2EXCCT	40	3200*	1400	3000-4000-6000	0,94	90°	230	73	210	1040	941284	12	

*the lumen and power data indicated refers to the 4000K colour temperature.

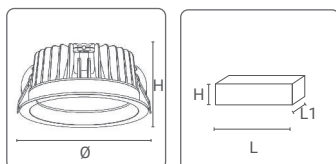

DRIVER 3": DRIVER 4": DRIVER 8":
 L= 70 mm L= 88 mm L= 132 mm
 L1= 33 mm L1= 38 mm L1= 45 mm
 H= 20.5 mm H= 22.5 mm H= 27 mm

DRIVER IP20 + KTEMR03

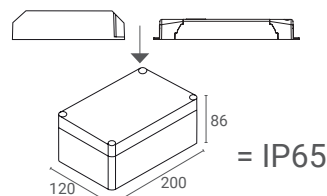

See the accessories page:



For photometries please consult the website.

HELIOS IP65



90°



7W

Ø85mm



12W

Ø125mm



40W

Ø210mm



Die-cast aluminium
body

Remote driver

REAL LUMENS

Luminous Flux Data is REAL. Values are measured on actual use conditions. Nominal values of the LED source are not stated.

Ø 100MM
3"

Ø 140MM
4"

Ø 230MM
8"

HELIOS IP65

TYPE

High efficiency SMD LED source integrated into a Class III IP65 downlight fixture.

CHARACTERISTICS

IP65 fixture both optical/front side and the back/component side; IP20 remote driver included in the package.

MOUNTING



Complete with springs for easy fastening into false ceilings. Cable (1 m) with IP65 quick connector.





MATERIALS

Aluminium finned dissipation body.

**FLICKER
FREE** 

Providing greater visual comfort, improved definition of detail and reduction of stress.

PRO	220-240V 50/60Hz	Ra>90		50000h L70 B20	IP65		-25° +45°C		G5/ h24	Risk Group 1
-----	---------------------	-------	---	-------------------	------	---	---------------	---	------------	-----------------

art.	W	lm	cd	K	PF		Ø	H			 8011905	
DH30L130EX	7	590	250	3000	0,9	90°	100	51	85	240	937478	36
DH30L140EX	7	590	250	4000	0,9	90°	100	51	85	240	937461	36
DH40L130EX	12	960	420	3000	0,9	90°	140	64	125	440	937454	27
DH40L140EX	12	960	420	4000	0,9	90°	140	64	125	440	937447	27
DH80L130EX	40	3200	1400	3000	0,94	90°	230	73	210	1040	937430	12
DH80L140EX	40	3200	1400	4000	0,94	90°	230	73	210	1040	937423	12

DIMMABILITY: HELIOS IP65 12W and 40W can be used with multi-current dimming power supply, code DELT40D-M
3 HOUR STANDBY LIGHTING. Can be used with Kit: KTEMRO3

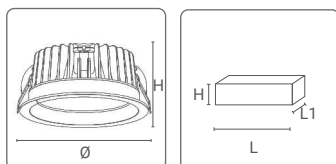

DRIVER 3": DRIVER 4": DRIVER 8":
 L= 70 mm L= 88 mm L= 132 mm
 L1= 33 mm L1= 38 mm L1= 45 mm
 H= 20.5 mm H= 22.5 mm H= 27 mm

DRIVER IP20 + KTEMRO3

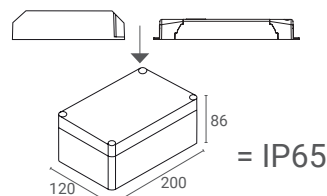

See the accessories page:



For photometries please consult the website.

HELIOS UGR RECESSED FIXTURES



UGR, LOW GLARE, ALUMINIUM BODY, RA >90

Ideal replacement for existing fittings using halogen lamps.

9W
 Ø65mm





14W
 Ø100mm



28W
 Ø150mm

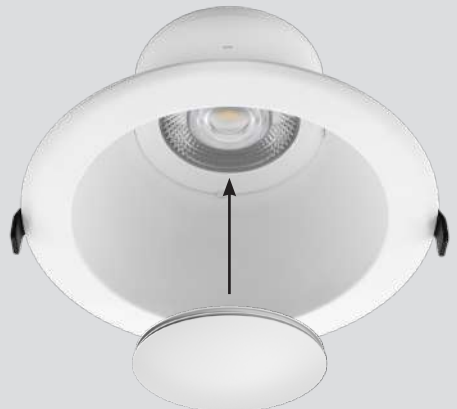

37W
 Ø200mm



REAL LUMENS

Luminous Flux Data is REAL. Values are measured on actual use conditions. Nominal values of the LED source are not stated.

HELIOS UGR RECESSED FIXTURES

TYPE

LED source with COB technology and an integrated high efficiency chip in a low glare UGR recessed light fixture.

CHARACTERISTICS

The deep recess of the light source combined with the advanced lens technology ensures glare ratings from UGR<11 to UGR<19. Applications include offices or places of work where computer screens are used and low glare is essential. A sealed light source provides easy maintenance and cleaning.

MOUNTING

Quick coupling system to false ceilings using springs.











MATERIALS

Aluminium body; extremely light and easy to manoeuvre.

FLICKER FREE 

Providing greater visual comfort, improved definition of detail and reduction of stress.





PRO	220-240V 50/60Hz	Ra>90		50000h L80 B20	IP20 VI IP43 VO	UGR<11 UGR<13 UGR<15 UGR<19		-25° +45°C		G5/ h24	Risk Group 1	 8011905 	
art.	W	lm	cd	K	PF	UGR		Ø	H			 8011905 	
DH25L130	9	850	1820	3000	0,95	19	36°	82	53	65	80	936792	50
+ KTDH25-LENS	9	750	460	3000	0,95	21	80°						
DH25L140	9	850	1820	4000	0,95	19	36°	82	53	65	80	936808	50
+ KTDH25-LENS	9	750	460	4000	0,95	21	80°						
DH40L130	14	1450	3800	3000	0,95	15	36°	118	60	100	100	936815	50
+ KTDH40-LENS	14	1050	650	3000	0,95	21	80°						
DH40L140	14	1450	3800	4000	0,95	15	36°	118	60	100	100	936822	50
+ KTDH40-LENS	14	1050	650	4000	0,95	21	80°						
DH60L130	28	2800	7250	3000	0,95	11	36°	172	98	150	220	936839	4
+ KTDH60-LENS	28	1900	1100	3000	0,95	21	80°						
DH60L140	28	2800	7250	4000	0,95	11	36°	172	98	150	220	936846	4
+ KTDH60-LENS	28	1900	1100	4000	0,95	21	80°						
DH80L130	37	3700	10300	3000	0,95	13	36°	230	128	200	400	936853	4
+ KTDH80-LENS	37	2700	1700	3000	0,95	21	80°						
DH80L140	37	3700	10300	4000	0,95	13	36°	230	128	200	400	936860	4
+ KTDH80-LENS	37	2700	1700	4000	0,95	21	80°						

DIMMABILITY: HELIOS UGR 14W/28W and 37W can be dimmed using multi-current dimming power supply, code DELT40D-M; 3 HOUR STANDBY LIGHTING. Can be used with Kit: KTEMRO3



Optional lenses

art	 8011905 
New KTDH25-LENS Ø 82 Angle Lens 80°	988036 5
New KTDH40-LENS Ø 118 Angle Lens 80°	987992 5
New KTDH60-LENS Ø 172 Angle Lens 80°	988005 5
New KTDH80-LENS Ø 230 Angle Lens 80°	988012 5

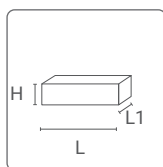
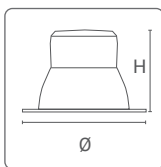

DRIVER 2,5": L= 100 mm L1= 40 mm H= 25 mm
DRIVER 4": L= 88 mm L1= 40 mm H= 23 mm
DRIVER 6": L= 117 mm L1= 43 mm H= 24 mm
DRIVER 8": L= 117 mm L1= 43 mm H= 24 mm

For photometries please consult the website.

VALO MINI

TYPE

Low thickness, small size LED downlights.

CHARACTERISTICS

Compact and easy to install. Tilt Adjustability 30°. Special design of the lens ensures excellent light beam diffusion. Non removable internal power supply.

MOUNTING

Complete with springs for easy fastening into false ceilings.

MATERIALS

Heat resistant, anti-yellowing plastic body.



BASIC	220-240V 50/60Hz	Ra>80		15000h L70 B30	IP20 VI IP23 VO		-25° +35°C		G2	Risk Group 0
--------------	---------------------	-------	--	-------------------	--------------------	--	---------------	--	----	-----------------



art.	W	lm	cd	K		L	L1	H				
New VA03L130Q	7	620	700	3000	40°	90	90	40	75x75	83	987725	10
New VA03L140Q	7	650	735	4000	40°	90	90	45	75x75	83	987732	10

• Minimum Order Quantity



art.	W	lm	cd	K		Ø	H				
New VA03L130T	7	620	700	3000	40°	90	40	72	80	987701	10
New VA03L140T	7	650	735	4000	40°	90	40	72	80	987718	10

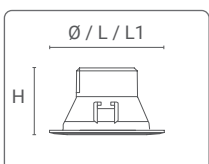

For photometries please consult the website.

LESELI MINI PRO

TYPE

Recessed LED fixtures with integrated drivers.

CHARACTERISTICS

A orientable optic with a dichroic effect. Tilt Adjustability 30°. The particular design of the lens ensures excellent diffusion of the light beam. Compact and easy to use. Non removable internal power supply. Flicker free.

MOUNTING

Complete with springs to affix easily into ceilings.

MATERIALS

Extruded powder coated aluminium body.



FLICKER FREE

Providing greater visual comfort, improved definition of detail and reduction of stress.

PRO	220-240V 50/60Hz	Ra>80		50000h L70 B20	IP20 VI IP23 VO		-25° +35°C		G5/ h24	Risk Group 1	
art.	W	lm	cd	K		Ø	H				
D306TWW	8	650	1740	3000	36°	85	55	68	182		20
D306TNW	8	680	1820	4000	36°	85	55	68	182		20

PRO	220-240V 50/60Hz	Ra>95		50000h L70 B20	IP20 VI IP23 VO		-25° +35°C		G5/ h24	Risk Group 1	
art.	W	lm	cd	K		Ø	H				
New D306TWW-D	9	550	1350	3000	36°	85	55	68	182		20
New D306TNW-D	9	575	1410	4000	36°	85	55	68	182		20

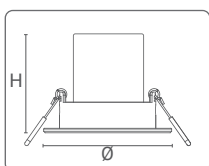

For photometries please consult the website.



TRACKLIGHT



PLUS

DURA BEAM TRACK LIGHT

Essential design, the classic cylinder, perfect in any interior. A best-selling range in the retail sector today with 50,000h lifetime and a new power: 40W, 3700 lumens and 7500 cd.



PRO

PROJECTOR DURA TL

Distinctively designed projectors in extruded aluminium. Aperture of 24° on low power and 40° for higher powers. A high-profile range for prestigious installations. 50.000h.



EUROSTANDARD PLUS

New codes but same options and accessories. The standard track version has been revised to achieve an optimised section and offer an even more elegant profile.

DURA BEAM - TRACK LIGHT



Die-cast painted aluminium body.

Integrated electronic driver.

The graduated ring opens by unscrewing and the lens can be replaced with a click.

Optimised optics for power.

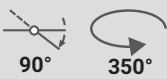

90°

350°

Cylindrical section and very small diameter:
50 mm 60 mm 80 mm

12W 20W 30W/40W

The centre of gravity always remains in axis with the track irrespective of where the projector is aimed.

Can be equipped with several 'beam-cutting' accessories to meet different project needs:

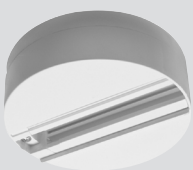

**ADAPTER FOR
SURFACE
INSTALLATIONS**



ANTI-GLARE LOUVRES

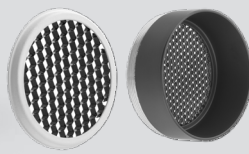

CUT OFF

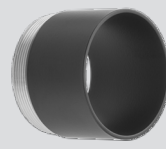

**ASYMMETRICAL
CUT OFF**

DURA BEAM - TRACK LIGHT

TYPE

Professional LED projectors for track mounting.

CHARACTERISTICS

Same shape with 3 different dimensions and 4 power choices to cover all requirements. Can be used with Eurostandard Plus tracks as well as with other brands': Staff, Nordlux, Nordic, Global, etc.

OPTIC

High efficiency **Ra>90** LED Chip on Board.
Precision optics with dichroic effect lens.
Adjustable from 0° to -90° on the vertical plane and 350° on the horizontal plane.

MATERIALS

Die-cast painted aluminium body; black or white colour.

MOUNTING

Onto an electrical track in 3 phases; fixtures equipped with a safety lock to fix to the tracks.

NB

Non Dimmable.

POWER SUPPLY

Electronic driver integrated in the fixture body.



PLUS	220-240V 50/60Hz	Ra>90		50000h L70 B20	IP20	-25° +35°C		G4	Risk Group 1
------	---------------------	-------	--	-------------------	------	---------------	--	----	-----------------

art.	W		lm	cd	K		∅	L	H		8011905	
TB50L130-W	12		920	6100	3000	15°	50	136	136	305	936884	20
TB50L140-W	12		990	6600	4000	15°	50	136	136	305	936907	20
TB50L130-B	12		920	6100	3000	15°	50	136	136	305	936891	20
TB50L140-B	12		990	6600	4000	15°	50	136	136	305	936914	20
TB60L130-W	20		1700	3496	3000	36°	60	148	146	394	936921	20
TB60L140-W	20		1800	3700	4000	36°	60	148	146	394	936945	20
TB60L130-B	20		1700	3496	3000	36°	60	148	146	394	936938	20
TB60L140-B	20		1800	3700	4000	36°	60	148	146	394	936952	20
TB80L130-W	30		2500	5670	3000	36°	80	190	166	673	936969	10
TB80L140-W	30		2700	5880	4000	36°	80	190	166	673	936983	10
TB80L130-B	30		2500	5140	3000	36°	80	190	166	673	936976	10
TB80L140-B	30		2700	5550	4000	36°	80	190	166	673	936990	10
New TB80L230-W *	40		3500	6850	3000	36°	80	200	166	660	984847	10
New TB80L240-W *	40		3700	7605	4000	36°	80	200	166	660	984854	10
New TB80L230-B *	40		3500	6850	3000	36°	80	200	166	660	984861	10
New TB80L240-B *	40		3700	7605	4000	36°	80	200	166	660	984878	10

* Available this autumn

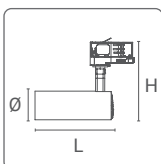

For photometries please consult the website.

DURA BEAM - TRACK LIGHT ACCESSORIES

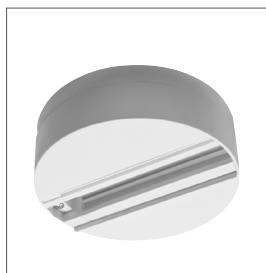

Adapter for surface installations

art		8007753			
B60220	<input checked="" type="checkbox"/>	309284		1	
B60221	<input type="checkbox"/>	309277		1	



Optional lenses

art		8011905			
KTTB60LENS	Ø 60 - 24° - 10 pcs	937249		1	
KTTB80LENS	Ø 80 - 24° - 10 pcs	937256		1	



Anti-glare grid

art		8011905		8011905			
KTTB50AGL-B	<input checked="" type="checkbox"/>	937010	KTTB50AGL-W	<input type="checkbox"/>	937003	Ø 50 - 5 pcs	1
KTTB80AGL-B	<input checked="" type="checkbox"/>	937058	KTTB80AGL-W	<input type="checkbox"/>	937041	Ø 80 - 5 pcs	1



'High' anti-glare grid

art		8011905		8011905			
KTTB50AGL1-B	<input checked="" type="checkbox"/>	937072	KTTB50AGL1-W	<input type="checkbox"/>	937065	Ø 50 - 5 pcs	1
KTTB80AGL1-B	<input checked="" type="checkbox"/>	937119	KTTB80AGL1-W	<input type="checkbox"/>	937102	Ø 80 - 5 pcs	1



Asymmetric cut off

art		8011905		8011905			
KTTB50ACO-B	<input checked="" type="checkbox"/>	937133	KTTB50ACO-W	<input type="checkbox"/>	937126	Ø 50 - 5 pcs	1
KTTB60ACO-B	<input checked="" type="checkbox"/>	937157	KTTB60ACO-W	<input type="checkbox"/>	937140	Ø 60 - 5 pcs	1
KTTB80ACO-B	<input checked="" type="checkbox"/>	937171	KTTB80ACO-W	<input type="checkbox"/>	937164	Ø 80 - 5 pcs	1

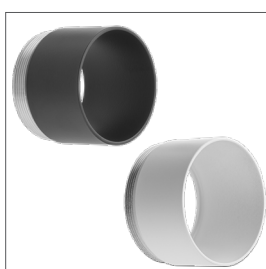

Cut off

art		8011905		8011905			
KTTB50ACO1-B	<input checked="" type="checkbox"/>	937195	KTTB50ACO1-W	<input type="checkbox"/>	937188	Ø 50 - 5 pcs	1
KTTB60ACO1-B	<input checked="" type="checkbox"/>	937218	KTTB60ACO1-W	<input type="checkbox"/>	937201	Ø 60 - 5 pcs	1
KTTB80ACO1-B	<input checked="" type="checkbox"/>	937232	KTTB80ACO1-W	<input type="checkbox"/>	937225	Ø 80 - 5 pcs	1



DURASTRIP

Real Plaza Puruchuco Shopping Mall, Lima, Peru
Lighting design by Rie Sakata

DURA TL - TRACK LIGHT



10W
SMALL



15W
MEDIUM



22W
MEDIUM



38W
LARGE

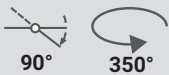

The centre of gravity always remains in axis with the track irrespective of where the projector is aimed.

ACCESSORIES FOR MEDIUM AND LARGE BODIES

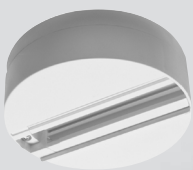

ADAPTER FOR
SURFACE
INSTALLATIONS



ANTI-GLARE
LOUVRE



BARN DOOR
FLAPS



ASYMMETRICAL

DURA TL - TRACK LIGHT

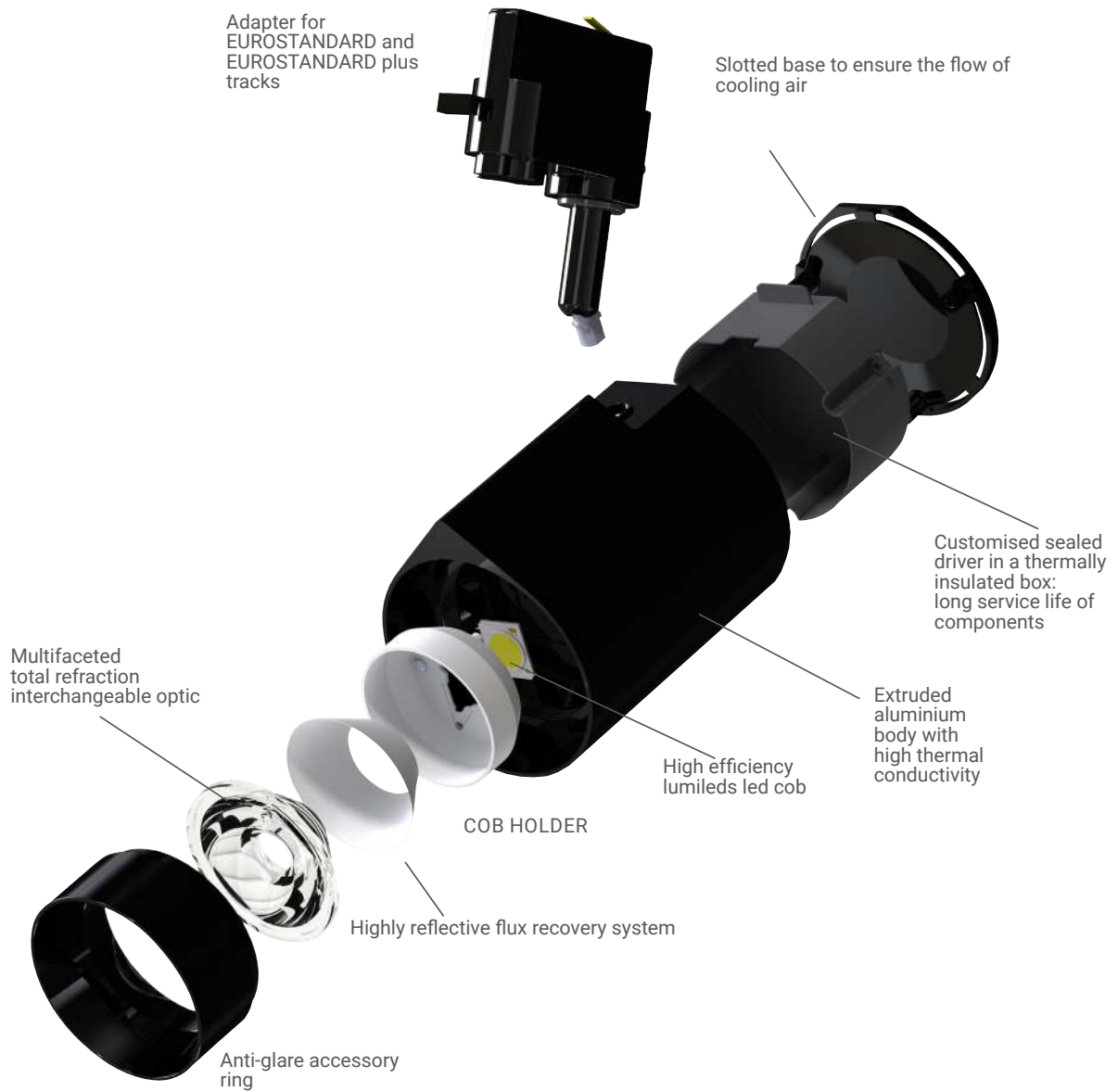

DURA TL - TRACK LIGHT

TYPE

Professional LED projectors for track mounting.

CHARACTERISTICS

3 different dimensions and 4 power choices to cover all requirements. Can be used with Eurostandard Plus tracks as well as with other brands': Staff, Nordlux, Nordic, Global, etc.

OPTIC

High efficiency Ra>90 LED Chip on Board. Precision optics with dichroic effect lens. Adjustable from 0° to -90° on the vertical plane and 350° on the horizontal plane.

MATERIALS

Die-cast painted aluminium body; black or white colour.

MOUNTING

Onto an electrical track in 3 phases; fixtures equipped with a safety lock to fix to the tracks.



NB

Non Dimmable.
TRIAC (200-250V) dimmable version on request.

POWER SUPPLY

Electronic driver integrated in the fixture body.

PRO	110-240V 50/60Hz	Ra>85		50000h L70 B20	IP20	-25° +35°C		G5/ h24	Risk Group 1
-----	---------------------	-------	--	-------------------	------	---------------	--	------------	-----------------

art.	W	lm	cd	K		Ø	L	H				
TD10S-3K8L-MSP-W	10		855	2090	3000	24°	60	95	167	370	902674	20
TD10S-4K8L-MSP-W	10		900	2200	4000	24°	60	95	167	370	863173	20
TD10S-3K8L-MSP-B	10		855	2090	3000	24°	60	95	167	370	902667	20
TD10S-4K8L-MSP-B	10		900	2200	4000	24°	60	95	167	370	861865	20
TD15M-3K8L-FL-W	15		1235	1890	3000	40°	100	108	184	648	902681	10
TD15M-4K8L-FL-W	15		1300	1990	4000	40°	100	108	184	648	851699	10
TD15M-3K8L-FL-B	15		1235	1890	3000	40°	100	108	184	648	902698	10
TD15M-4K8L-FL-B	15		1300	1990	4000	40°	100	108	184	648	851705	10
TD22M-3K8L-FL-W	22		2185	3135	3000	40°	100	108	184	648	902711	10
TD22M-4K8L-FL-W	22		2300	3300	4000	40°	100	108	184	648	863241	10
TD22M-3K8L-FL-B	22		2185	3135	3000	40°	100	108	184	648	902704	10
TD22M-4K8L-FL-B	22		2300	3300	4000	40°	100	108	184	648	861872	10
TD38L-3K8L-FL-W	38		3800	5795	3000	40°	111	141	189	927	851668	10
TD38L-4K8L-FL-W	38		4000	6100	4000	40°	111	141	189	927	863197	10
TD38L-3K8L-FL-B	38		3800	5795	3000	40°	111	141	189	927	851682	10
TD38L-4K8L-FL-B	38		4000	6100	4000	40°	111	141	189	927	861896	10

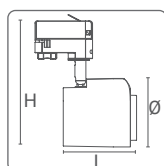

For photometries please consult the website.

ACCESSORIES DURA TL - TRACK LIGHT





Adapter for surface installations

art			
B60220		309284	1
B60221		309277	1





Optional lenses

art				
TDM-LENS24	24° lens for MEDIUM BODY	24°	861254	10
TDM-LENS60	60° lens for MEDIUM BODY	60°	861261	10
TDL-LENS24	24° lens for LARGE BODY	24°	861308	10
TDL-LENS60	60° lens for LARGE BODY	60°	861315	10





Anti-glare louvre

art			
TDM-AGL	 Anti-glare louvre for MEDIUM BODY	861278	6
TDL-AGL	 Anti-glare louver for LARGE BODY	861322	6







Barn door flaps

art			
TDM-BDF	 Barn door flaps for MEDIUM BODY	861285	6
TDL-BDF	 Barn door flaps for LARGE BODY	861339	6



Asymmetrical

art			
TDM-ACO	 Asymmetric cut-off for MEDIUM BODY	861292	6
TDL-ACO	 Asymmetric cut-off for LARGE BODY	861346	6

EUROSTANDARD PLUS

TYPE

System is a 3 phase mixed system with two additional conductors intended to manage a general data signal (for example DALI, DMX). Electrified track in three lengths in extruded anodized aluminum or in extruded painted aluminium. Conductors in copper insulated in PVC.

MOUNTING

There are three possible installation systems: directly on false ceiling (using the needlepoints on the track and the suspension kit), on ceiling using a metal clip or hanging by a mounting kit.

POWER SUPPLY

Frequency: 50Hz.
Rated current and voltage: L1/L2/L3/N/ground 16A/440V + D+/D- 2x1A/50V FELV AC (DALI).
Phase / phases power: 3,6kVA / 10,8kVA.

EUROSTANDARD
PLUS

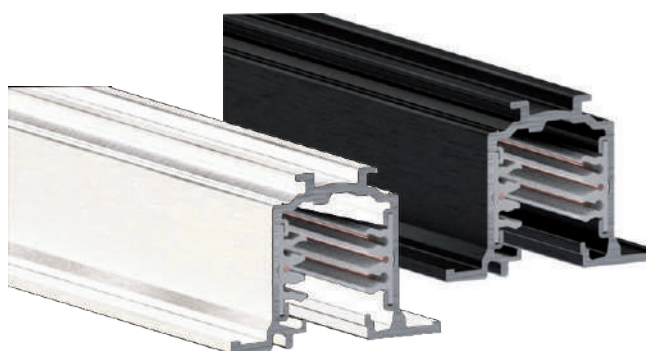

TRACKS

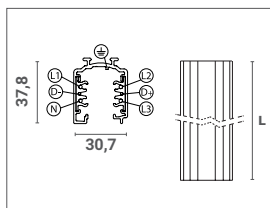

Standard

art.		L		
B60-1SB	B60-1SW	1000	1100	1
B60-2SB	B60-2SW	2000	2100	1
B60-3SB	B60-3SW	3000	3100	1

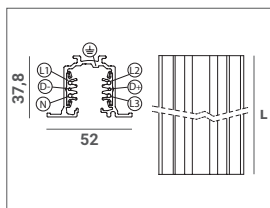

Recessed

art.		L		
B60-1RB	B60-1RW	1000	1100	1
B60-2RB	B60-2RW	2000	2200	1
B60-3RB	B60-3RW	3000	3400	1

END CAPS

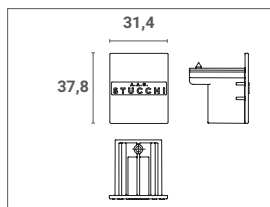

Dead end

art.			
B604B	B604W	1	1

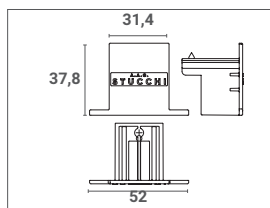

Dead end – recessed

art.			
B604RB	B604RW	1	1

The photos show the colour white to improve the visibility of the elements: the code alongside refers to the colour black.

MOUNTING SYSTEMS

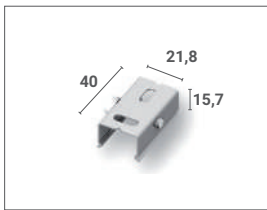

Ceiling mounting bracket

art.

B60111



1

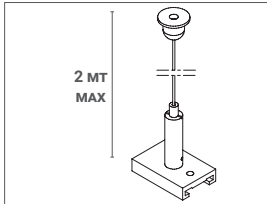

Mounting systems suspension

art.

B60SP



1

POWER SUPPLY

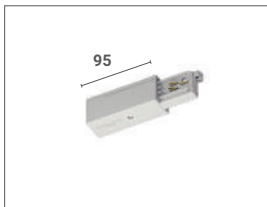

Power supplies lateral polarity on the right

art.

B601B



B601W



1

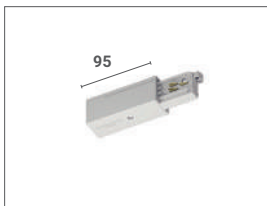

Power supplies lateral polarity on the left

art.

B602B



B602W



1

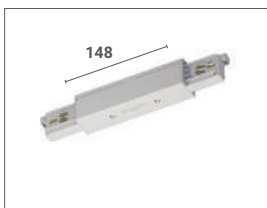

Power supplies central

art.

B6010B



B6010W



1

LATERAL FEEDING SYSTEMS ACCESSORIES

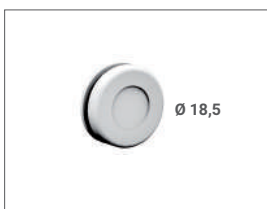

Seal for lateral power supply

art.

B60115B



B60115W



1

PVC. for: B601...; B602...

The photos show the colour white to improve the visibility of the elements:
the code alongside refers to the colour black.

ELECTRICAL CONNECTOR

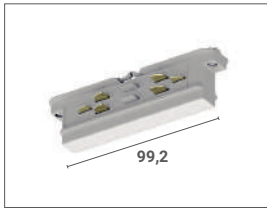

Connectors straight

art.

B603B	<input checked="" type="checkbox"/>	B603W	<input type="checkbox"/>			1
-------	-------------------------------------	-------	--------------------------	--	--	---

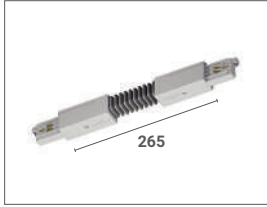

Connectors flexible

art.

B6018B	<input checked="" type="checkbox"/>	B6018W	<input type="checkbox"/>			1
--------	-------------------------------------	--------	--------------------------	--	--	---

Cannot be used for the recessed track

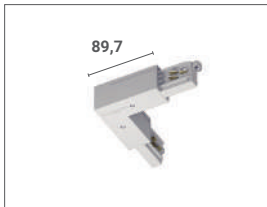

"L" joint internal polarity

art.

B6011B	<input checked="" type="checkbox"/>	B6011W	<input type="checkbox"/>			1
--------	-------------------------------------	--------	--------------------------	--	--	---

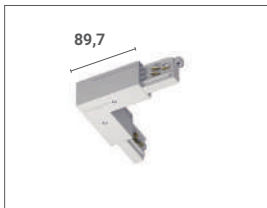

"L" joint external polarity

art.

B6012B	<input checked="" type="checkbox"/>	B6012W	<input type="checkbox"/>			1
--------	-------------------------------------	--------	--------------------------	--	--	---



"T" joint external polarity

art.

B6013B	<input checked="" type="checkbox"/>	B6013W	<input type="checkbox"/>	SX		1
B6014B	<input checked="" type="checkbox"/>	B6014W	<input type="checkbox"/>	DX		1



"T" joint internal polarity

art.

B6015B	<input checked="" type="checkbox"/>	B6015W	<input type="checkbox"/>	SX		1
B6016B	<input checked="" type="checkbox"/>	B6016W	<input type="checkbox"/>	DX		1

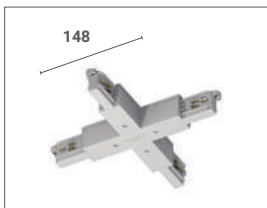

"X" joint

art.

B6017B	<input checked="" type="checkbox"/>	B6017W	<input type="checkbox"/>			1
--------	-------------------------------------	--------	--------------------------	--	--	---

Note: All joints except the linear joint can be used as power supply.

COVER PANELS FOR RECESSED TRACK

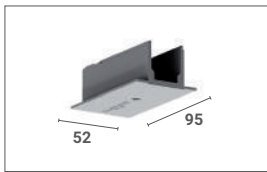

COVER false ceiling cover for lateral power supply.

art.

B60RC1B B60RC1W



1

Polycarbonate body for: B60001/...; B60002/...

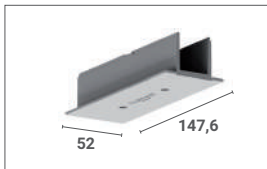

COVER false ceiling cover for central power supply

art.

B60RC10B B60RC10W



1

Polycarbonate body for: B60010/...;

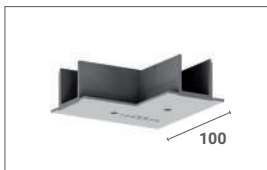

COVER "L" connector for false ceiling

art.

B60RC11B B60RC11W



1

Polycarbonate body for: B60011/...; B60012/...;

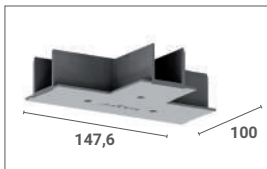

COVER "T" connector for false ceiling

art.

B60RC13B B60RC13W



1

Polycarbonate body for: B60013/...; B60014/...; B60015/...; B60016/...

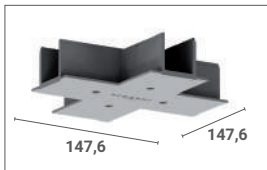

COVER "X" connector for false ceiling

art.

B60RC17B B60RC17W



1

Polycarbonate body for: B60017

ACCESSORIES

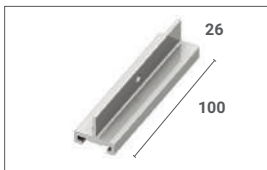

Rigid support bracket

art.

B60123



1

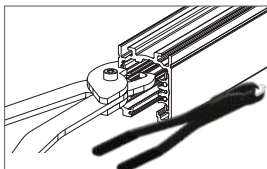

Tool for shearing conductors, to be used if it's necessary to cut the track during the installation.

art.

B60T



1

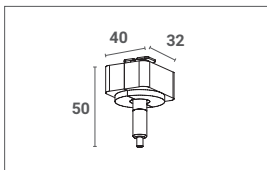

Suspension bracket

art.

B60MB B60MW



1

Adapter for surface installations

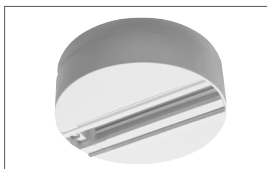

art

B60220



1

B60221

1

EUROSTANDARD PLUS

ELECTRICAL SCHEME

During the wiring the electrical scheme of picture must be followed.

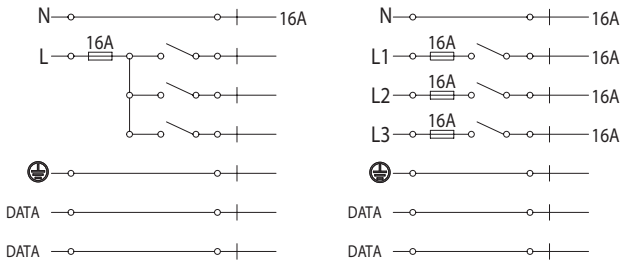

LOAD SCHEME

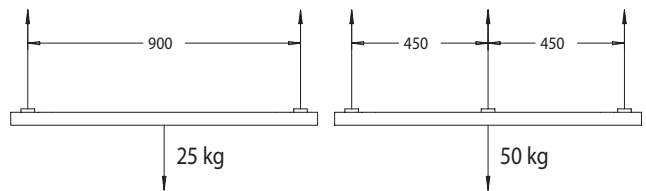

INSTALLATION

There is a polarity on the lighting track to guarantee the right connection of the multiple pieces of the track. Also end-feeds and connection joints have a polarity that must be taken into account in order to choose the right component. In the catalogue sketches of these articles, the position of the polarity is highlighted with a red line.

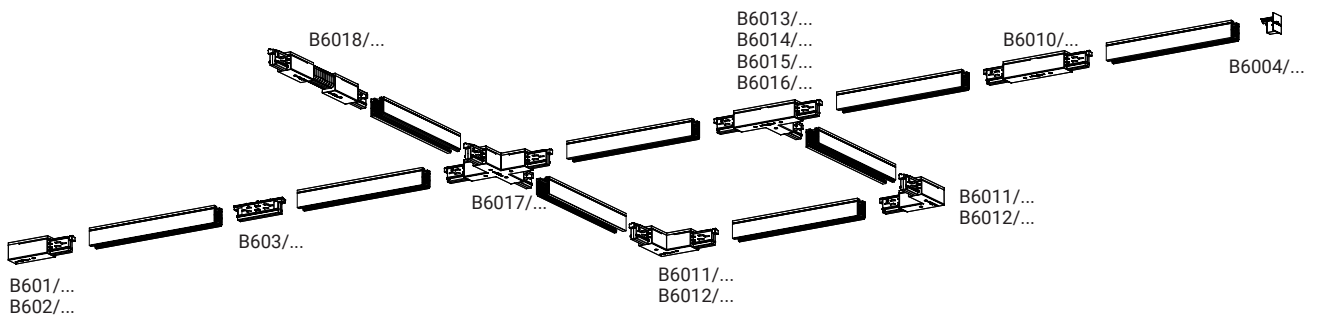

Lateral power supplies

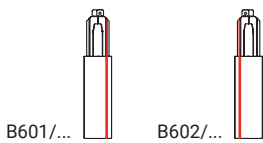

Central power supplies

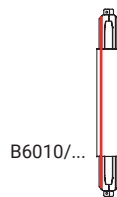

"L" Joint

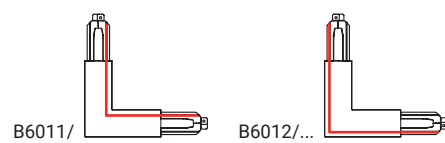

"T" Joint

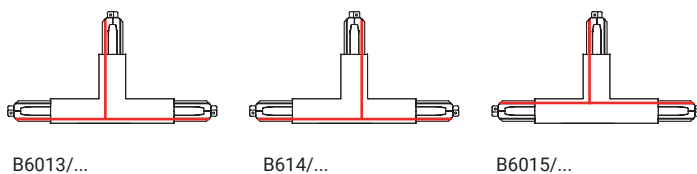

"X" Joint

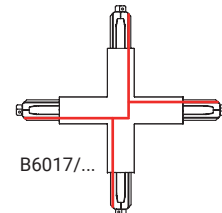

Top view



DURA BEAM

3000K and 4000K

LED PANELS



BASIC

SLIMFLUX SL
NWB5 + UGR

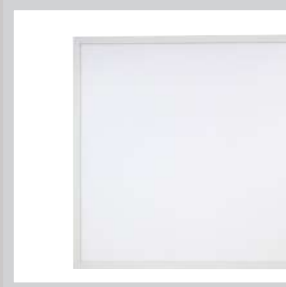

PRO

SLIMFLUX SL
S1 + UGR

SIDELIGHT



BACKLIGHT

LED PANELS

NEW



PLUS

SLIMFLUX PANEL
ROUND 60

NEW



PLUS

SLIMFLUX PANEL
UP&DOWN
TRANSLUCENT
DIMMABLE PANEL

NEW



PRO

SLIMFLUX Q4



BASIC

SLIMFLUX BL
B3



PLUS

SLIMFLUX BL
B1 + B2
+ UGR



PRO

SLIMFLUX BL
B1 + UGR



PLUS

SLIMFLUX BL
P1+P2
PLAFO + UGR

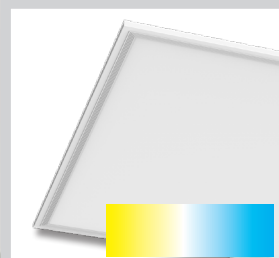
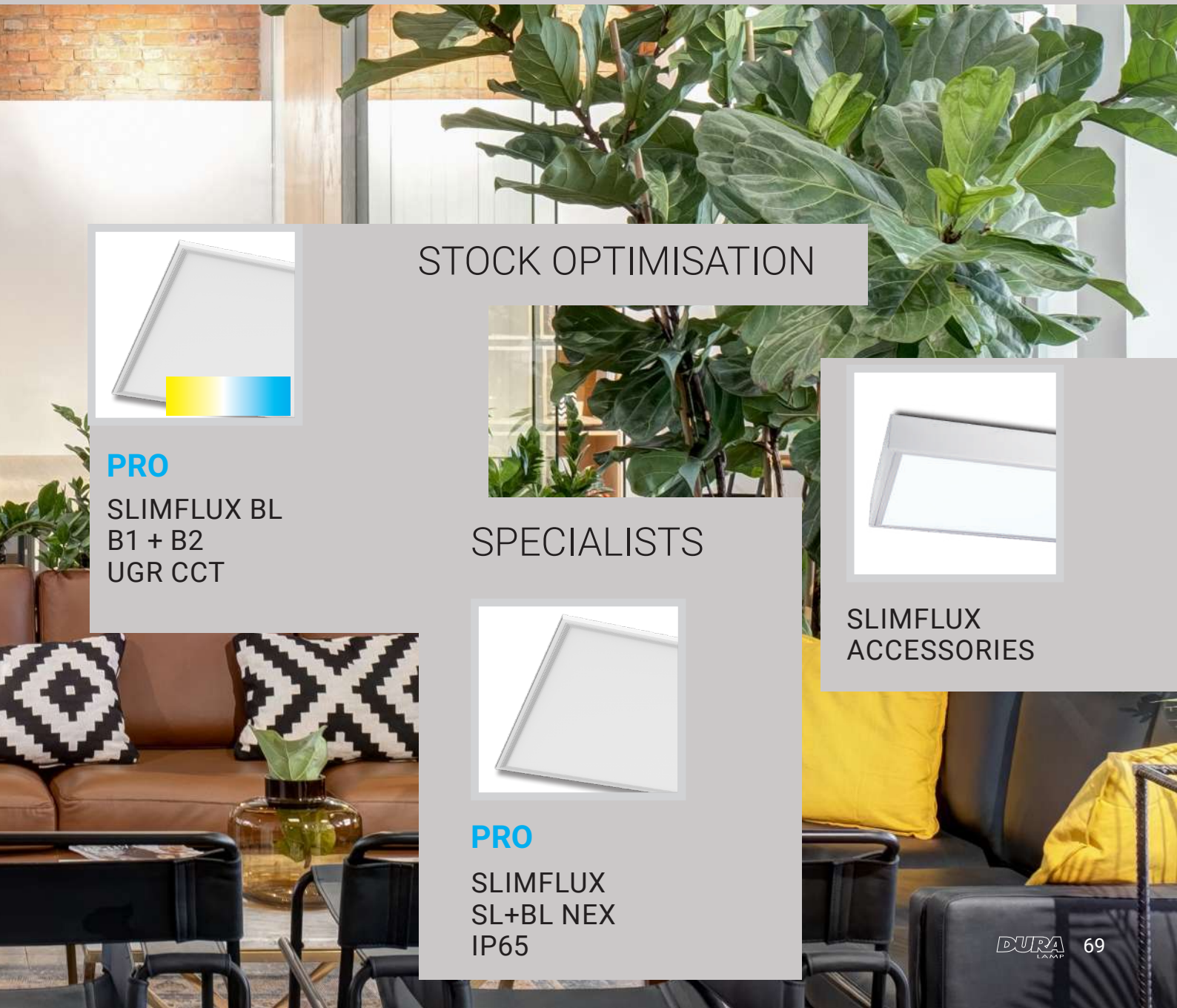

PRO

SLIMFLUX BL
B1 + B2
UGR CCT

STOCK OPTIMISATION



SPECIALISTS

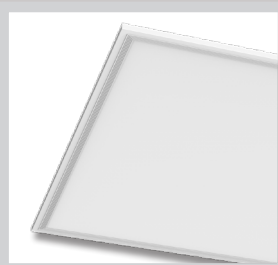

PRO

SLIMFLUX
SL+BL NEX
IP65



SLIMFLUX
ACCESSORIES

SO MANY OPTIONS WHEN CHOOSING A PANEL? FIND THE FEATURES YOU YOU NEED!

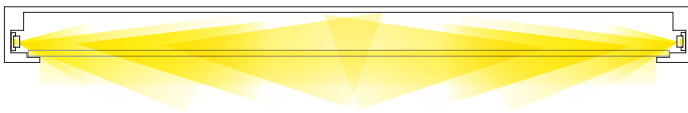
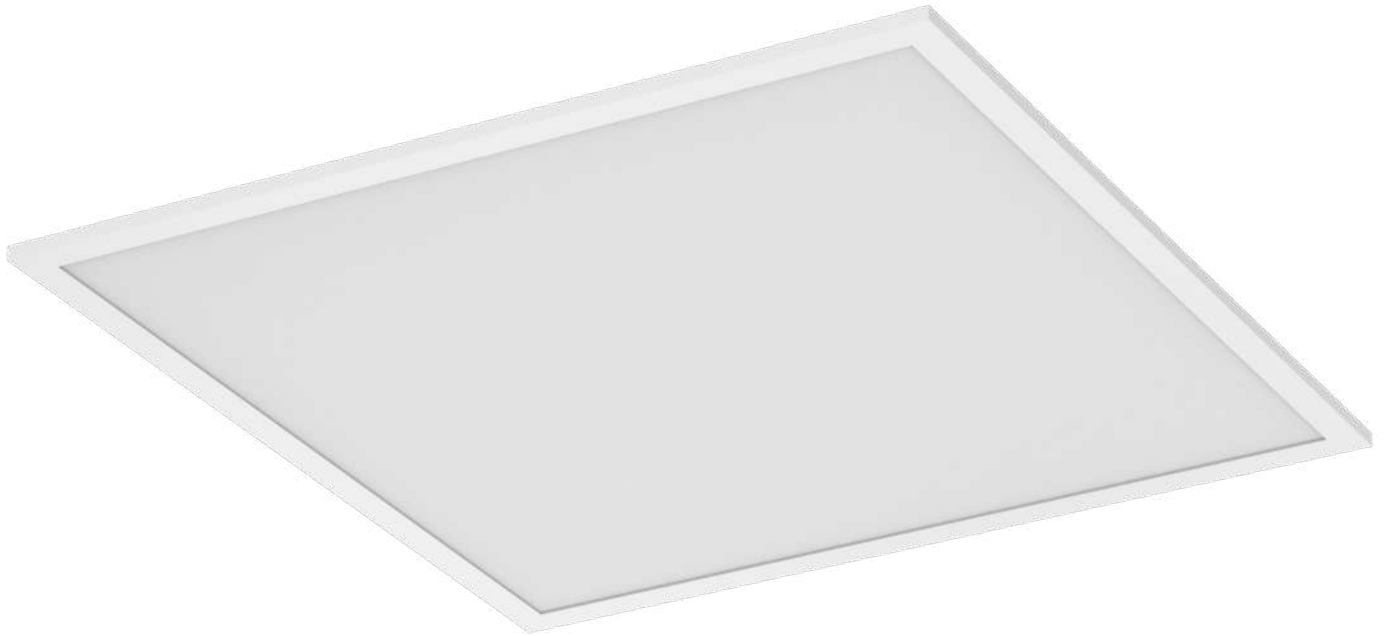

Sidelight LED PANELS SL: SIDELIGHT

Side Light technology is widely used in the production of LED panels. The light emission comes from the profiles embedded in the frame and is reflected uniformly on the surface of the front screen. The advantage is a very light panel with a thickness of just a few millimetres.





25000h
G2



35000h
G3



50000h
G4h24

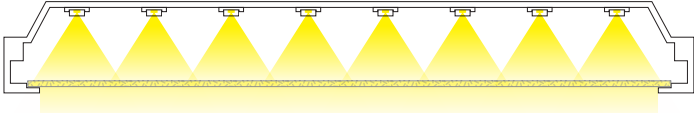

BACKLIGHT PANELS

BL: DIRECT LIGHTING

The positioning of the LEDs on a horizontal plate parallel to the screen guarantees uniformity of illumination and excellent efficiency.

The rear compartment, a few centimetres thick, is functional to housing the backlighting and optimising heat dissipation.



LOOKING FOR A LED PANEL?

BASIC

25000h
G2

PLUS

35000h
G3

PRO

50000h
G4h24

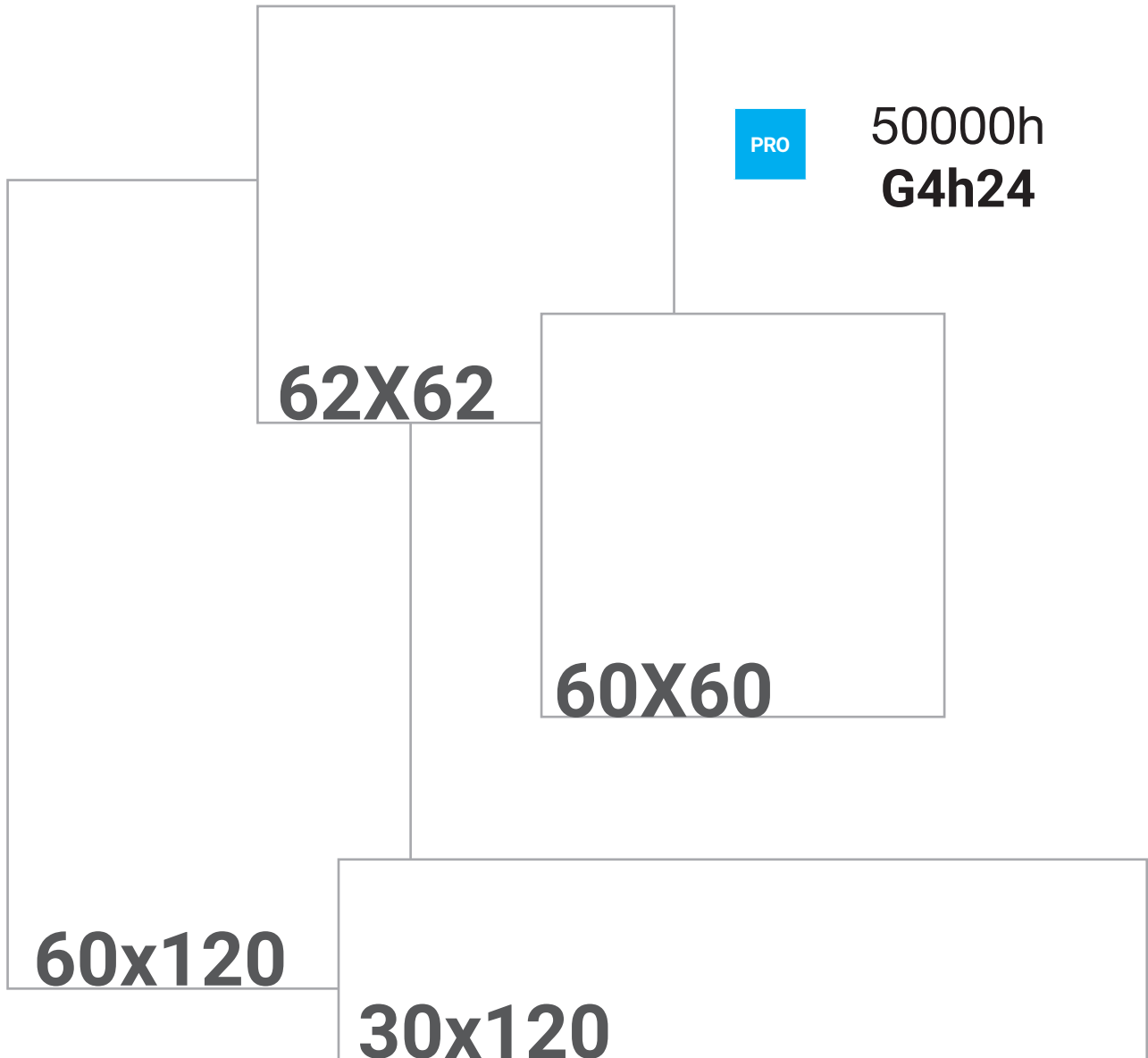

SLIMFLUX SL

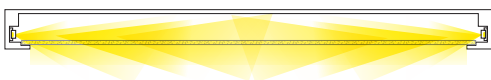

SIDLIGHT LED PANELS
SIDE ILLUMINANCE

SLIMFLUX BL

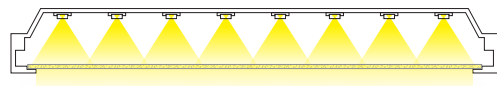

BACKLIGHT LED PANELS
DIRECT ILLUMINANCE

	art.	W	BL/SL	lm	Kelvin	UGR	Ra	IP	
BASIC	LP6060B3-830	40	BL	3400	3000K		80	IP20	
BASIC	LP6060B3-840	40	BL	3600	4000K		80	IP20	
BASIC	LP6060B3-860	40	BL	3600	6000K		80	IP20	
BASIC	LP6060NWB5	40	SL	3600	4000K		80	IP20	
BASIC	LP6060NWB5-UGR	40	SL	3600	4000K	•	80	IP20	
PLUS	LP6060B2-840	40	BL	4000	4000K		80	IP20	
PLUS	LP6060B2UGR-840	40	BL	4000	4000K	•	80	IP20	
PLUS	LP6060B1UGR-930	40	BL	3000	4000K	•	90	IP20	
PLUS	LP6060B2UGR-940	40	BL	4000	4000K	•	90	IP20	
PLUS	LP6060P1-840	<input type="checkbox"/>	40	BL	4000	4000K		80	IP20
PLUS	LP6060P2-840	<input type="checkbox"/>	60	BL	6000	4000K		80	IP20
PLUS	LP6060P2-860	<input type="checkbox"/>	60	BL	6000	6000K		80	IP20
PLUS	LP6060P1UGR-840	<input type="checkbox"/>	40	BL	4000	4000K	•	80	IP20
PRO	LP6060S1UGR-830	40	SL	3800	3000K	•	80	IP20	
PRO	LP6060S1UGR-840	40	SL	4000	4000K	•	80	IP20	
PRO	LP6060S1UGR-940	40	SL	3600	4000K	•	90	IP20	
PRO	LP6060B1-830	40	BL	4000	3000K		80	IP20	
PRO	LP6060B1-840	40	BL	4000	4000K		80	IP20	
PRO	LP6060B1-860	40	BL	6000	4000K		80	IP20	
PRO	LP6060B1-840HP	50	BL	5200	4000K		80	IP20	
PRO	LP6060B1UGR-840HP	45	BL	5500	4000K	•	80	IP20	
PRO	LP6060B1UGR-840	40	BL	4000	4000K	•	80	IP20	
PRO	LP6060B1UGR-940	40	BL	4000	4000K	•	90	IP20	
PRO	LP6060B1UGR-8CCT	40	BL	4500*	3/4/6000K	•	80	IP20	
PRO	LP6060B2UGR-8CCT	47	BL	5500*	3/4/6000K	•	80	IP20	
PRO	LP6060B1UGR-9CCT	40	BL	4000*	3/4/6000K	•	90	IP20	
PRO	LP6060NEX	36	SL	3300	4000K		80	IP65	
PRO	LP6060B1NEX	40	BL	4000	4000K		80	IP65	
PRO	LP6262S1UGR-830 **	36	SL	4000	3000K	•	80	IP20	
PRO	LP6262S1UGR-840 **	40	SL	4000	4000K	•	80	IP20	
PRO	LP6262UGR-840	40	SL	4000	4000K	•	80	IP20	
BASIC	LP30120NWB5-UGR	40	SL	3600	4000K	•	80	IP20	
PLUS	LP30120B2-840	40	BL	4000	4000K		80	IP20	
PLUS	LP30120B2-860	40	BL	4000	6000K		80	IP20	
PLUS	LP30120B2UGR-940	40	BL	4000	4000K	•	90	IP20	
PLUS	LP30120P1-840 <input type="checkbox"/>	40	BL	4000	4000K		80	IP20	
PRO	LP30120S1UGR-940	40	SL	3600	4000K	•	90	IP20	
PRO	LP30120B1-840	40	BL	4000	4000K		80	IP20	
PRO	LP30120B1UGR-9CCT	40	BL	4000*	3/4/6000K	•	90	IP20	
PLUS	LP60120P1-840 <input type="checkbox"/>	60	BL	6000	4000		80	IP20	
PRO	LP60120B1-840	50	BL	5000	4000		80	IP20	
PRO	LP60120B1UGR-9CCT	50	BL	5200*	3/4/6000K	•	90	IP20	

60X60

62X62

30x120

60x120

* Lumen and power data are referred to 4000K colour temperature.



** Project only.

Version with integrated frame for surface mounting.

SLIMFLUX SL + UGR BASIC SIDELIGHT

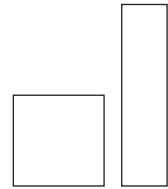
BASIC 220-240V 50/60Hz Ra>80  25000h L70B20 IP20 VI IP43 VO -25° +35°C  G2 Risk Group 0 **FLICKER FREE** 



art.	W	lm	K	Ra	PF	L	L1	H	UGR		
60x60											
New LP6060NWB5	40	3600	4000	80	0,9	595	595	10	-	1700	5
New LP6060NWB5-UGR	40	3600	4000	80	0,9	595	595	10	<19	1700	5
30x120											
New LP30120NWB5-UGR	40	3600	4000	80	0,9	295	1195	10	<19	2300	5

- BASIC: anti-yellowing PS screen.
- SLIMFLUX SL - BASIC: 5 pieces pack with single items' box.

NOTE:

- The one-piece frames are equipped with a rear bracket to be fixed to the ceiling. Kit frames are fixed directly to the ceiling: the panel is slid inside the three sides already fixed before closing.

SLIMFLUX SL + UGR BASIC

BASIC SIDELIGHT



LPLAFO60	LPLAFO603	LPLAFO604	LPLAFO60P	LPLAFO30120	LPLAFO1203	LPLAFO301204	LPLAFO601204	KTLP-SPU	LP-SSK	FASTCON-30	KTLPW1-MS	KTEMR03	OPTIONAL DRIVERS	DELT65D-M
----------	-----------	-----------	-----------	-------------	------------	--------------	--------------	----------	--------	------------	-----------	---------	------------------	-----------



•	•	•	•												LP6060NWB5
•	•	•	•												LP6060NWB5-UGR
				•	•	•									LP30120NWB5-UGR



Monoblock Frames
LPLAFO60 thickness 6 cm
LPLAFO120 thickness 6 cm



Mounting kit frames
LPLAFO603 thickness 5cm
LPLAFO1203 thickness 5cm
LPLAFO604 thickness 8cm
LPLAFO301204 thickness 8cm



Frame with springs for flush mounting (kit to be assembled)
LPLAFO60P



Power supply for backup lighting
KTEMR03



Anti-fall safety wire and terminal block LP-SSK
Only terminal block FASTCON-30



Adjustable suspension wires kit
KTLP-SPU



Metal springs kit for recessed installation
KTLPW1-MS





ON/OFF, multicurrent dimmable DALI and 1-10V drivers: see driver section

SLIMFLUX BL - BASIC BACKLIGHT

BASIC	220-240V 50/60Hz	Ra>80		25000h L70B20	IP20 VI IP43 VO	-25° +35°C		G2	Risk Group 0
--------------	---------------------	-------	---	------------------	--------------------	---------------	---	-----------	-----------------



art.	W	lm	K	Ra	PF	L	L1	H	UGR		
60x60											
New LP6060B3-830	40	3400	3000	80	0,95	595	595	30	-	1100	6
New LP6060B3-840	40	3600	4000	80	0,95	595	595	30	-	1100	6
New LP6060B3-860	40	3600	6000	80	0,95	595	595	30	-	1100	6

- BASIC: anti-yellowing PS screen.
- SLIMFLUX BL - BASIC: 6 pieces pack with single items' protection plastic bag.
- New efficiency upgrade to 30W from next autumn.

• Minimum Order Quantity

NOTES:

- Insulation Class I panels cannot be made dimmable by changing the driver nor can they be used with the ballast for stand-by lighting.
- Pay attention to the thickness of the backlit panels. In these panels the driver is recessed between the rear compartment and the edge of the panel and does not extrude from the total thickness shown in the table.
- When installing BL panels with a surface frame, using dimmable drivers or backlighting drivers, it is necessary to order the frames with a height of 8 cm.
- The one-piece frames are equipped with a rear bracket to be fixed to the ceiling. Kit frames are fixed directly to the ceiling: the panel is slid inside the three sides already fixed before closing.

SLIMFLUX BL - BASIC BACKLIGHT

LPLAFO60
LPLAFO603
LPLAFO604
LPLAFO60P
LPLAFO30120
LPLAFO1203
LPLAFO301204
LPLAFO601204
KTLP-SPU
LP-SSK
FASTCON-30
KTLPW1-MS
KTEMR03
OPTIONAL DRIVERS
DELT65D-M

-
-
-
-

-
-
-
-

LP6060B3-830

LP6060B3-840

LP6060B3-860



Monoblock Frames
LPLAFO60 thickness 6 cm
LPLAFO120 thickness 6 cm



Mounting kit frames
LPLAFO603 thickness 5cm
LPLAFO1203 thickness 5cm
LPLAFO604 thickness 8cm
LPLAFO301204 thickness 8cm



Frame with springs for flush mounting (kit to be assembled)
LPLAFO60P



Power supply for backup lighting
KTEMR03



Anti-fall safety wire and terminal block LP-SSK
Only terminal block FASTCON-30



Adjustable suspension wires kit
KTLP-SPU



Metal springs kit for recessed installation
KTLPW1-MS



ON/OFF, multicurrent and dimmable drivers: see driver's section

SLIMFLUX BL + UGR - PLUS BACKLIGHT

PLUS	220-240V 50/60Hz	Ra>80 Ra>90		35000h L70 B20	IP20 VI IP43 VO	-25° +40°C			G3	Risk Group 0
------	---------------------	----------------	--	-------------------	--------------------	---------------	--	--	----	-----------------

**FLICKER
FREE**

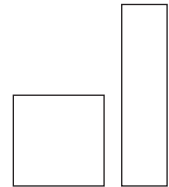

art.	W	lm	K	Ra	PF	L	L1	H	UGR		
60x60											
New LP6060B2-840 ⁽¹⁾	40	4000	4000	80	0,9	595	595	26	-	1700	6
30x120											
New LP30120B2-840	40	4000	4000	80	0,9	295	1195	26	-	1800	6
New LP30120B2-860	40	4000	6000	80	0,9	295	1195	26	-	1800	6
60x60 - UGR											
New LP6060B2UGR-840 ⁽¹⁾	40	4000	4000	80	0,9	595	595	26	<19	1800	6
New LP6060B2UGR-940 ⁽¹⁾	40	4000	4000	90	0,9	595	595	26	<19	1800	6
LP6060B1UGR-930 **	40	4000	3000	90	0,9	595	595	30	<19	2050	6
30x120 - UGR											
New LP30120B2UGR-940	40	4000	4000	90	0,9	295	1195	26	<19	2050	6

(1) Class I product

** Anti-yellowing PS screen, 50.000h

- PLUS PANELS: high transmittance optical PMMA screen.

- SLIMFLUX BL - PLUS: 6 pieces pack with single items' box (except 60x120, 3 pieces).

- SLIMFLUX BL PLAFO - PLUS: 5 pieces pack with single items' box.

NOTES:

- Insulation Class I panels cannot be made dimmable by changing the driver nor can they be used with the ballast for stand-by lighting.
- Pay attention to the thickness of the backlit panels. In these panels the driver is recessed between the rear compartment and the edge of the panel and does not extrude from the total thickness shown in the table.
- When installing BL panels with a surface frame, using dimmable drivers or backlighting drivers, it is necessary to order the frames with a height of 8 cm.
- The one-piece frames are equipped with a rear bracket to be fixed to the ceiling. Kit frames are fixed directly to the ceiling: the panel is slid inside the three sides already fixed before closing.

SLIMFLUX BL + UGR - PLUS BACKLIGHT

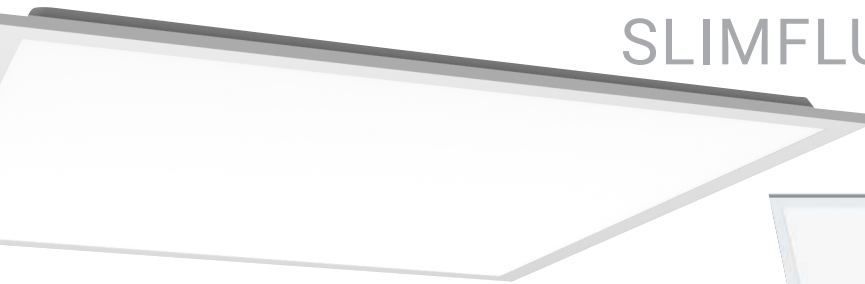

LPLAFO60	LPLAFO603	LPLAFO604	LPLAFO60P	LPLAFO30120	LPLAFO1203	LPLAFO301204	LPLAFO601204	KTLP-SPU	LP-SSK	FASTCON-30	KTLPW1-MS	KTEMR03	OPTIONAL DRIVERS	DELT65D-M
----------	-----------	-----------	-----------	-------------	------------	--------------	--------------	----------	--------	------------	-----------	---------	------------------	-----------



•	•	•	•					•	•	•					LP6060B2-840 *
				•	•	•		•	•	•		•	•		LP30120B2-840
				•	•	•		•	•	•		•	•		LP30120B2-860
•	•	•	•					•	•	•					LP6060B2UGR-840 *
•	•	•	•					•	•	•					LP6060B2UGR-940 *
•	•	•	•					•	•	•		•	•		LP6060B1UGR-930 **
				•	•	•		•	•	•		•	•		LP30120B2UGR-940



Monoblock Frames
LPLAFO60 thickness 6 cm
LPLAFO120 thickness 6 cm



Mounting kit frames
LPLAFO603 thickness 5cm
LPLAFO1203 thickness 5cm
LPLAFO604 thickness 8cm
LPLAFO301204 thickness 8cm



Frame with springs for flush mounting (kit to be assembled)
LPLAFO60P



Power supply for backup lighting
KTEMR03



Anti-fall safety wire and terminal block LP-SSK
Only terminal block FASTCON-30



Adjustable suspension wires kit
KTLP-SPU



Metal springs kit for recessed installation
KTLPW1-MS



ON/OFF, multicurrent and dimmable drivers: see driver's section

SLIMFLUX BL PLAFO + UGR PLUS BACKLIGHT



PLUS
220-240V
50/60Hz
Ra>80
35000h
L70 B20
IP20 V1
IP43 VO
-25°
+35°C
G3
Risk
Group 0

**FLICKER
FREE**

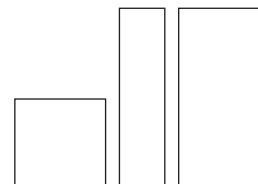

art.	W	lm	K	Ra	PF	L	L1	H	UGR		
60x60											
LP6060P1-840	40	4000	4000	80	0,95	600	600	40	-	2000	5
New LP6060P2-840	60	6000	4000	80	0,9	595	595	40	-	2100	5
LP6060P2-860	60	6000	6000	80	0,95	600	600	40	-	2100	5
30x120											
LP30120P1-840	40	4000	4000	80	0,95	300	1200	40	-	2400	5
60x120											
LP60120P1-840	60	6000	4000	80	0,95	600	1200	40	-	4500	3
60x60 - UGR											
LP6060P1UGR-840	40	4000	4000	80	0,95	600	600	40	<19	2300	5

Anti-yellowing PS screen.

- PLUS PANELS: high transmittance optical PMMA screen.

- SLIMFLUX BL PLAFO - PLUS: 5 pieces pack with single items' box.

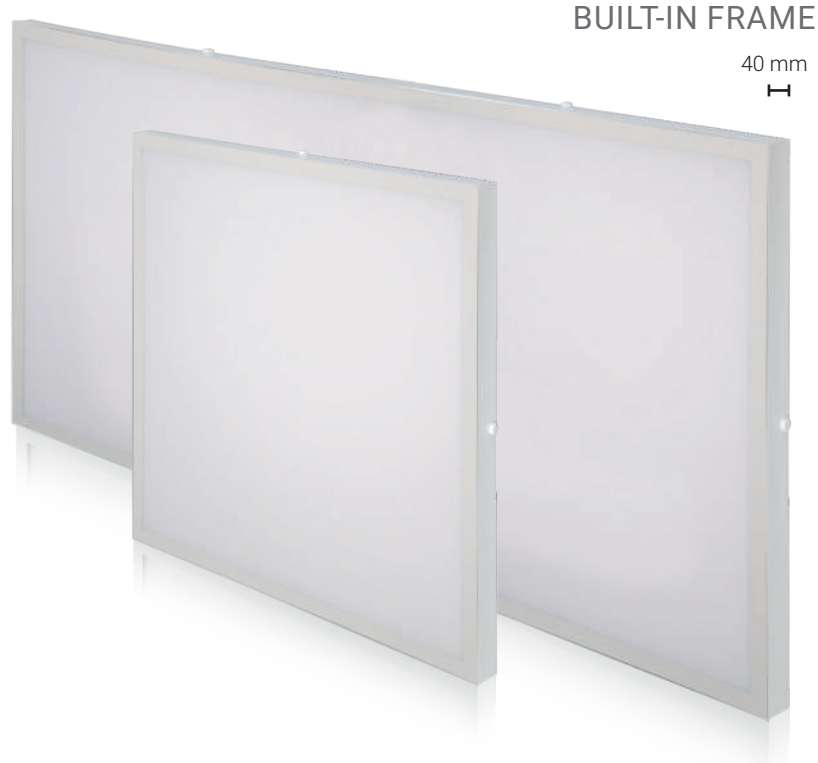

BUILT-IN FRAME



40 mm
H





SLIMFLUX

4000K

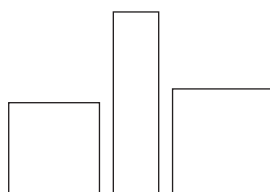
SLIMFLUX SL UGR - PRO SIDELIGHT

PRO
220-240V
50/60Hz
Ra>80
Ra>90

50000h
L80 B20
IP20 VI
IP43 VO
-25°
+40°C

G5/
h24
Risk
Group 0
**FLICKER
FREE**



art.	W	lm	K	Ra	PF	L	L1	H	UGR			
60x60 - UGR												
New	LP6060S1UGR-830	40	3800	3000	80	0,9	595	595	8,4	<19	2050	5
New	LP6060S1UGR-840	40	4000	4000	80	0,9	595	595	8,4	<19	2050	5
New	LP6060S1UGR-940	40	3600	4000	90	0,9	595	595	8,4	<19	2050	5
30x120 - UGR												
New	LP30120S1UGR-940	40	3600	4000	90	0,9	1195	295	8,4	<19	2300	5
62x62 - UGR												
New	LP6262S1UGR-830 **	40	4000	3000	80	0,9	620	620	8,6	<19	2050	5
New	LP6262S1UGR-840 **	40	4000	4000	80	0,9	620	620	8,6	<19	2050	5
	LP6262UGR-840 *	31/37	4000	3730/4300	80	0,95	620	620	9	<19	2400	5

- SLIMFLUX SL - PRO: high transmittance optical PMMA screen.

- 5 pieces pack with single items' box.

* To be discontinued. This panel does NOT include the driver: please select the required product from the range.

** Only upon project and with MOQ.

NOTES:

- The one-piece frames are equipped with a rear bracket to be fixed to the ceiling. Kit frames are fixed directly to the ceiling: the panel is slid inside the three sides already fixed before closing.

SLIMFLUX SL UGR - PRO SIDELIGHT



LPLAFO60
LPLAFO603
LPLAFO604
LPLAFO60P
LPLAFO30120
LPLAFO1203
LPLAFO301204
LPLAFO601204
KTLP-SPU
LP-SSK
FASTCON-30
KTLPW1-MS
KTEMR03
OPTIONAL DRIVERS
DELT65D-M

•	•	•	•	•	•	•	•	•	•	•	•	LP6060S1UGR-830
•	•	•	•									LP6060S1UGR-840
												LP6060S1UGR-940
				•	•	•	•	•	•	•	•	LP30120S1UGR-940
												LP6262S1UGR-830 **
												LP6262S1UGR-840 **
												LP6262UGR-840 *

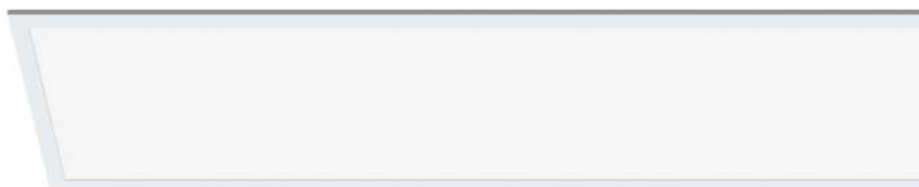

Monoblock Frames
LPLAFO60 thickness 6 cm
LPLAFO120 thickness 6 cm



Mounting kit frames
LPLAFO603 thickness 5cm
LPLAFO1203 thickness 5cm
LPLAFO604 thickness 8cm
LPLAFO301204 thickness 8cm



Frame with springs for flush mounting (kit to be assembled)
LPLAFO60P



Power supply for backup lighting
KTEMR03



Anti-fall safety wire and terminal block LP-SSK
Only terminal block FASTCON-30



Adjustable suspension wires kit
KTLP-SPU



Metal springs kit for recessed installation
KTLPW1-MS



ON/OFF, multicurrent and dimmable drivers: see driver's section

SLIMFLUX BL + UGR - PRO BACKLIGHT



PRO	220-240V 50/60Hz	Ra>80		50000h L80 B20	IP20 VI IP43 VO	-25° +40°C		G5/ h24	Risk Group 0	FLICKER FREE			
------------	---------------------	-------	--	-------------------	--------------------	---------------	--	------------	-----------------	-------------------------	--	--	--

	art.	W	lm	K	Ra	PF	L	L1	H	UGR		
	60x60											
New	LP6060B1-830	40	4000	3000	80	0,9	595	595	30	-	1700	6
New	LP6060B1-840	40	4000	4000	80	0,9	595	595	30	-	1700	6
New	LP6060B1-860	40	4000	6000	80	0,9	595	595	30	-	1700	6
New	LP6060B1-840HP	50	5200	4000	80	0,9	595	595	32	-	1800	6
	30x120											
New	LP30120B1-840	40	4000	4000	80	0,9	295	1195	30	-	1800	6
	60x120											
New	LP60120B1-840	50	5000	4000	80	0,9	595	1195	30	-	4150	4
	60x60 - UGR											
New	LP6060B1UGR-840	40	4000	4000	80	0,9	595	595	30	<19	2050	6
New	LP6060B1UGR-940	40	4000	4000	90	0,9	595	595	30	<19	2050	6
New	LP6060B1UGR-840HP	45	5500	4000	80	0,9	595	595	30	<19	2050	6

- SLIMFLUX BL - PRO: anti-yellowing PS screen.
- 6 pieces pack with single items' box (except 60x120, 4 pieces).

NOTES:

- Pay attention to the thickness of the backlit panels. In these panels the driver is recessed between the rear compartment and the edge of the panel and does not extrude from the total thickness shown in the table.
- When installing BL panels with a surface frame, using dimmable drivers or backlighting drivers, it is necessary to order the frames with a height of 8 cm.
- The one-piece frames are equipped with a rear bracket to be fixed to the ceiling. Kit frames are fixed directly to the ceiling: the panel is slid inside the three sides already fixed before closing.



SLIMFLUX BL + UGR - PRO BACKLIGHT



LPLAFO60	LPLAFO603	LPLAFO604	LPLAFO60P	LPLAFO30120	LPLAFO1203	LPLAFO301204	LPLAFO601204	KTLP-SPU	LP-SSK	FASTCON-30	KTLPW1-MS	KTEMR03	OPTIONAL DRIVERS	DELT65D-M
----------	-----------	-----------	-----------	-------------	------------	--------------	--------------	----------	--------	------------	-----------	---------	------------------	-----------

•	•	•						•	•	•		•	•	LP6060B1-830
•	•	•						•	•	•		•	•	LP6060B1-840
•	•	•						•	•	•		•	•	LP6060B1-860
•	•	•						•	•	•		•	•	LP6060B1-840HP
				•		•		•	•	•				LP30120B1-840
							•	•	•			•	•	LP60120B1-840
•	•	•						•	•	•		•	•	LP6060B1UGR-840
•	•	•						•	•	•		•	•	LP6060B1UGR-940
•	•	•						•	•	•		•	•	LP6060B1UGR-840HP



Monoblock Frames
LPLAFO60 thickness 6 cm
LPLAFO120 thickness 6 cm



Mounting kit frames
LPLAFO603 thickness 5cm
LPLAFO1203 thickness 5cm
LPLAFO604 thickness 8cm
LPLAFO301204 thickness 8cm



Frame with springs for flush mounting (kit to be assembled)
LPLAFO60P



Power supply for backup lighting
KTEMR03



Anti-fall safety wire and terminal block LP-SSK
Only terminal block FASTCON-30



Adjustable suspension wires kit
KTLP-SPU



Metal springs kit for recessed installation
KTLPW1-MS



ON/OFF, multicurrent and dimmable drivers: see driver's section

SLIMFLUX BL UGR CCT - PRO BACKLIGHT

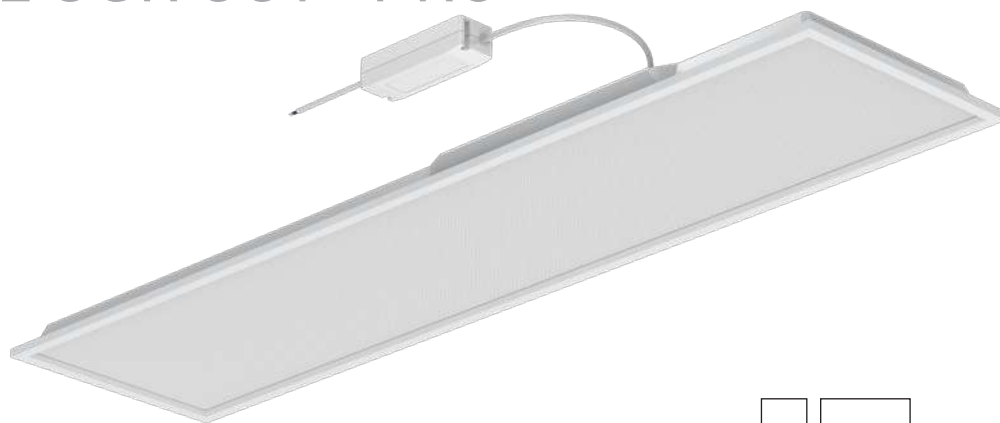

PRO
220-240V
50/60Hz
Ra>80
Ra>90
50000h
L80 B20
IP20 VI
IP43 VO
-25°
+40°C
G5/
h24
Risk
Group 0
**FLICKER
FREE**

art.	W	lm	K	Ra	PF	L	L1	H	UGR		
60x60											
LP6060B1UGR-8CCT**	40	4500*	3000/4000/6000	80	0,95	595	595	40	<19	2230	4
LP6060B2UGR-8CCT**	47	5500*	3000/4000/6000	80	0,95	595	595	40	<19	2230	4
LP6060B1UGR-9CCT**	40	4000*	3000/4000/6000	90	0,95	595	595	40	<19	2230	4
30x120											
LP30120B1UGR-9CCT**	40	4000*	3000/4000/6000	90	0,95	295	1195	40	<19	2950	4
60x120											
LP60120B1UGR-9CCT**	50	5200*	3000/4000/6000	90	0,95	595	1195	40	<19	3960	4

• Minimum Order Quantity

- * Lumen and power data are referred to 4000K colour temperature.
- SLIMFLUX BL CCT - PRO: anti-yellowing PS screen. 4 pieces pack with single items' protection plastic bag.
- ** To be discontinued

NOTES:

- Pay attention to the thickness of the backlit panels. In these panels the driver is recessed between the rear compartment and the edge of the panel and does not extrude from the total thickness shown in the table.
- When installing BL panels with a surface frame, using dimmable drivers or backlighting drivers, it is necessary to order the frames with a height of 8 cm.
- The one-piece frames are equipped with a rear bracket to be fixed to the ceiling. Kit frames are fixed directly to the ceiling: the panel is slid inside the three sides already fixed before closing.

SLIMFLUX BL UGR CCT - PRO BACKLIGHT



LPLAFO60	LPLAFO603	LPLAFO604	LPLAFO60P	LPLAFO30120	LPLAFO1203	LPLAFO301204	LPLAFO601204	KTLP-SPU	LP-SSK	FASTCON-30	KTLPW1-MS	KTEMR03	OPTIONAL DRIVERS	ZK600-1400S
----------	-----------	-----------	-----------	-------------	------------	--------------	--------------	----------	--------	------------	-----------	---------	------------------	-------------



•	•	•						•	•	•				• LP6060B1UGR-8CCT **
•	•	•						•	•	•				• LP6060B2UGR-8CCT **
•	•	•						•	•	•				• LP6060B1UGR-9CCT **
				•		•		•	•	•				• LP30120B1UGR-9CCT **
							•		•	•				• LP60120B1UGR-9CCT **

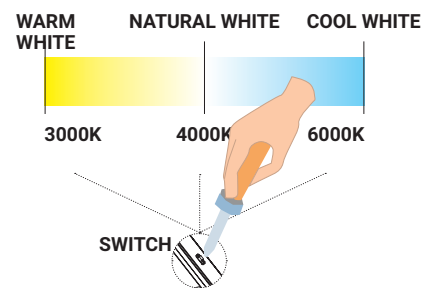

Monoblock Frames
LPLAFO60 thickness 6 cm
LPLAFO120 thickness 6 cm



Mounting kit frames
LPLAFO603 thickness 5cm
LPLAFO1203 thickness 5cm
LPLAFO604 thickness 8cm
LPLAFO301204 thickness 8cm



Frame with springs for flush mounting (kit to be assembled)
LPLAFO60P



Power supply for backup lighting
KTEMR03



Anti-fall safety wire and terminal block LP-SSK
Only terminal block FASTCON-30



Adjustable suspension wires kit
KTLP-SPU



Metal springs kit for recessed installation
KTLPW1-MS



ON/OFF, multicurrent and dimmable drivers: see driver's section

SLIMFLUX SL+BL IP65 - PRO

SIDELIGHT + BACKLIGHT

PRO	220-240V 50/60Hz	Ra>80		50000h L70 B20	IP65	-25° +40°C		G5/ h24	Risk Group 0
-----	---------------------	-------	--	-------------------	------	---------------	--	------------	-----------------

**FLICKER
FREE**



SLIMFLUX SL IP65 - PRO

art.	W	lm	K	Ra	PF	L	L1	H	UGR		
60x60											
LP6060NEX **	36	3300	4000	80	0,95	595	595	11,5	-	4100	4

** To be discontinued

SLIMFLUX BL IP65 - PRO

art.	W	lm	K	Ra	PF	L	L1	H	UGR		
60x60											
New LP6060B1NEX	40	4000	4000	80	0,9	595	595	32	-	2300	6

- High transmittance optical PMMA screen.
- Equipped with a GORE-TEX® valve to compensate for pressure variations
- SLIMFLUX SL IP65 - PRO: 4 pieces pack with single items' box.
- SLIMFLUX BL IP65 - PRO: 6 pieces pack with single items' box.

NOTES:

- Pay attention to the thickness of the backlit panels. In these panels the driver is recessed between the rear compartment and the edge of the panel and does not extrude from the total thickness shown in the table.
- When installing BL panels with a surface frame, using dimmable drivers or backlighting drivers, it is necessary to order the frames with a height of 8 cm.
- The one-piece frames are equipped with a rear bracket to be fixed to the ceiling. Kit frames are fixed directly to the ceiling: the panel is slid inside the three sides already fixed before closing.



SLIMFLUX SL+BL IP65 - PRO

SIDELIGHT + BACKLIGHT

LPLAFO60	LPLAFO603	LPLAFO604	LPLAFO60P	LPLAFO30120	LPLAFO1203	LPLAFO301204	LPLAFO601204	KTLP-SPU	LP-SSK	FASTCON-30	KTLPW1-MS	KTEMR03	OPTIONAL DRIVERS	ZK600-14000S
----------	-----------	-----------	-----------	-------------	------------	--------------	--------------	----------	--------	------------	-----------	---------	------------------	--------------



-
-
-

-
-
-

LP6060NEX **

-
-
-

-
-
-

LP6060B1NEX



Monoblock Frames
LPLAFO60 thickness 6 cm
LPLAFO120 thickness 6 cm



Mounting kit frames
LPLAFO603 thickness 5cm
LPLAFO1203 thickness 5cm
LPLAFO604 thickness 8cm
LPLAFO301204 thickness 8cm



Frame with springs for flush mounting (kit to be assembled)
LPLAFO60P



Power supply for backup lighting
KTEMR03



Anti-fall safety wire and terminal block LP-SSK
Only terminal block FASTCON-30



Adjustable suspension wires kit
KTLP-SPU



Metal springs kit for recessed installation
KTLPW1-MS



ON/OFF, multicurrent and dimmable drivers: see driver's section

SLIMFLUX Q4

PRO	220-240V 50/60Hz	Ra>80		50000h L70 B20	IP20 VI IP43 VO	UGR<13	-25° +35°C		G5/ h24	Risk Group 1
-----	---------------------	-------	--	-------------------	--------------------	--------	---------------	--	------------	-----------------



art.	W	lm	cd	K		Ra	PF	L	L1	H	UGR		
60x60													
New LP6060WWQ4	35	4100	4550	3000	60°	80	0,9	595	595	23	<13	3000	5
LP6060NWQ4	35	4500	5000	4000	60°	80	0,9	595	595	23	<13	3000	5

- SLIMFLUX Q4 - PRO: 5 pieces pack with single items' box.

SLIMFLUX 60X60 Q4 ACCESSORIES



art	L	L1	
KTLPQ4-MS	55	26	1

Metal springs kit for recessed installation - 4 pieces



art	L	
KTLPQ4-SP	1500	1

Cables kit for suspension installation

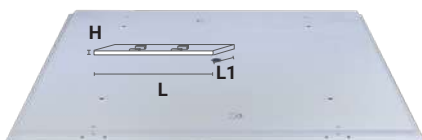

art	L	L1	H	
KTLPQ4-SM	565	565	14,6	1

Surface installation kit



The peculiar shape of each reflector, together with the set back source positioning, allow for precise control of the light emission and the reduction of glare, obtaining UGR<13.

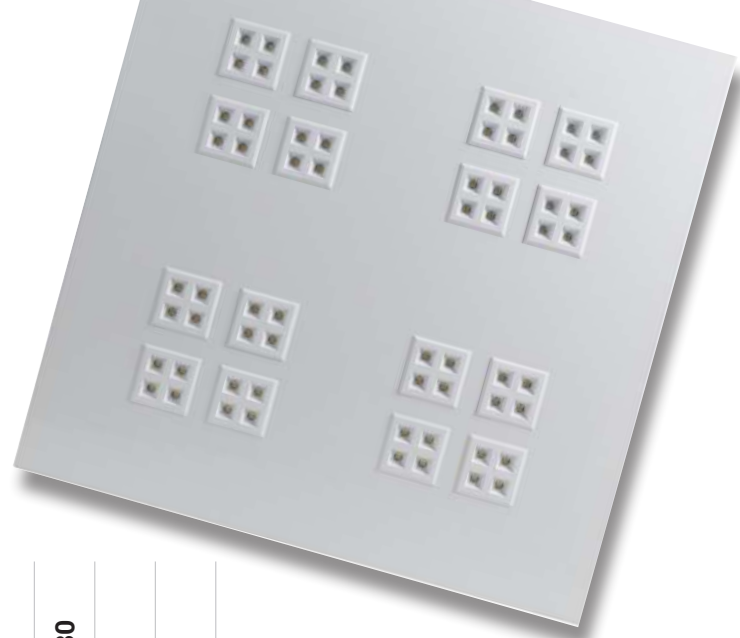

LPLAFO60	LPLAFO603	LPLAFO604	LPLAFO60P	LPLAFO30120	LPLAFO1203	LPLAFO301204	LPLAFO601204	KTLPQ4-SP	KTLPQ4-SM	KTLPQ4-MS	LP-SSK	FASTCON-30	KTEMR03	OPTIONAL DRIVERS
----------	-----------	-----------	-----------	-------------	------------	--------------	--------------	-----------	-----------	-----------	--------	------------	---------	------------------

•	•	•	•					•	•	•	•	•	•	•	•	LP6060WWQ4
•	•	•	•					•	•	•	•	•	•	•	•	LP6060NWQ4



Surface installation kit
KTLPQ4-SM thickness 1,5 cm



Mounting kit frames
LPLAFO603 thickness 5cm
LPLAFO1203 thickness 5cm
LPLAFO604 thickness 8cm
LPLAFO301204 thickness 8cm



Frame with springs for flush mounting (kit to be assembled)
LPLAFO60P



Power supply for backup lighting
KTEMR03



Anti-fall safety wire and terminal block LP-SSK
Only terminal block FASTCON-30



Adjustable suspension wires kit
KTLPQ4-SP





Kit of 4 built-in springs
KTLPQ4-MS





ON/OFF, multicurrent and dimmable drivers: see driver's section

SLIMFLUX ROUND - PLUS



PLUS 220-240V 50/60Hz Ra>80  30000h L70 B20 IP20 -25° +35°C  **G3** Risk Group 0



SLIMFLUX ROUND SURFACE MOUNTING - PLUS

	art.	W	lm	K	Ra	PF	Ø	L1	H	UGR		
New	LP60T830-A	40	3800	3000	80	0,9	592	33	19,5	-	3600	5
New	LP60T840-A	40	4000	4000	80	0,9	592	33	19,5	-	3200	5

SLIMFLUX ROUND TRANSLUCENT UP&DOWN SUSPENSION - PLUS

	art.	W	lm	K	Ra	PF	Ø	L1	H	UGR		
New	LP60T830DE-A	40	3800	3000	80	0,9	592	-	19,5	-	3200	5
New	LP60T840DE-A	40	4000	4000	80	0,9	592	-	19,5	-	3600	5

- High transmittance optical PMMA screen.
- Double emission upwards and downwards.
- SLIMFLUX ROUND - PLUS: 5 pieces pack with single items' box.

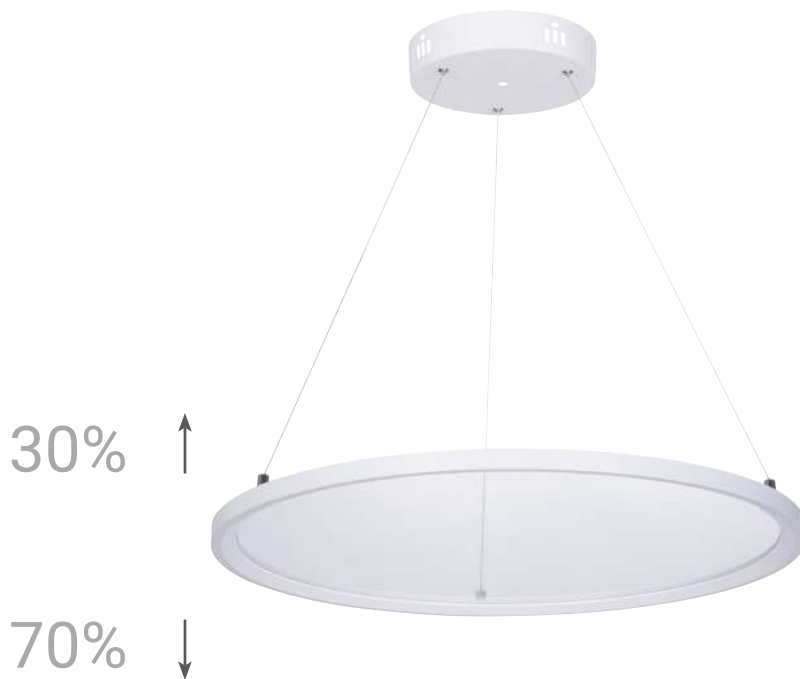

The power cable is one with the suspension cables, therefore invisible.

Light is diffused from the fine white frame to the methacrylate panel. Fractioned by micro incisions on the panel light is directed predominantly downwards. 30% of the light is projected upwards to create a striking effect that adds to any classic or modern environment.

NOTES:
The Round Translucent Up&Down panels are complete with suspension cables and driver integrated in the ceiling rose. Maximum suspension length 150 cm.

SLIMFLUX TRANSLUCENT UP&DOWN - PLUS

PLUS	220-240V 50/60Hz	Ra>80		30000h L70 B20	IP20		-25° +35°C		G3	Risk Group 0
------	---------------------	-------	--	-------------------	------	--	---------------	--	----	-----------------

	art.	W	lm	K	Ra	PF	L	L1	H	UGR		
New	LP30120T830DE-A	40	3800	3000	80	0,9	300	1200	14,5	-	3800	5
New	LP30120T840DE-A	40	4000	4000	80	0,9	300	1200	14,5	-	3800	5

- High transmittance optical PMMA screen.
- Double emission upwards and downwards.
- SLIMFLUX TRANSLUCENT UP&DOWN - PLUS: 5 pieces pack with single items' box.

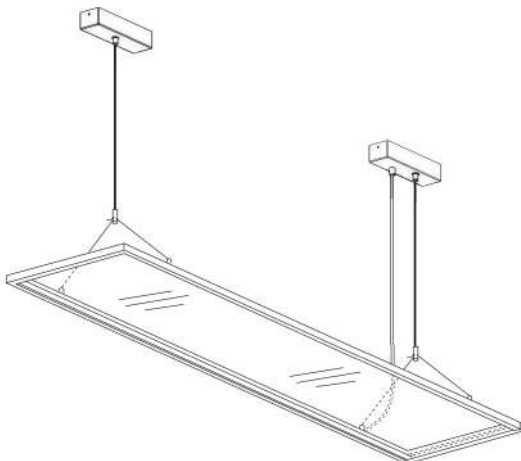

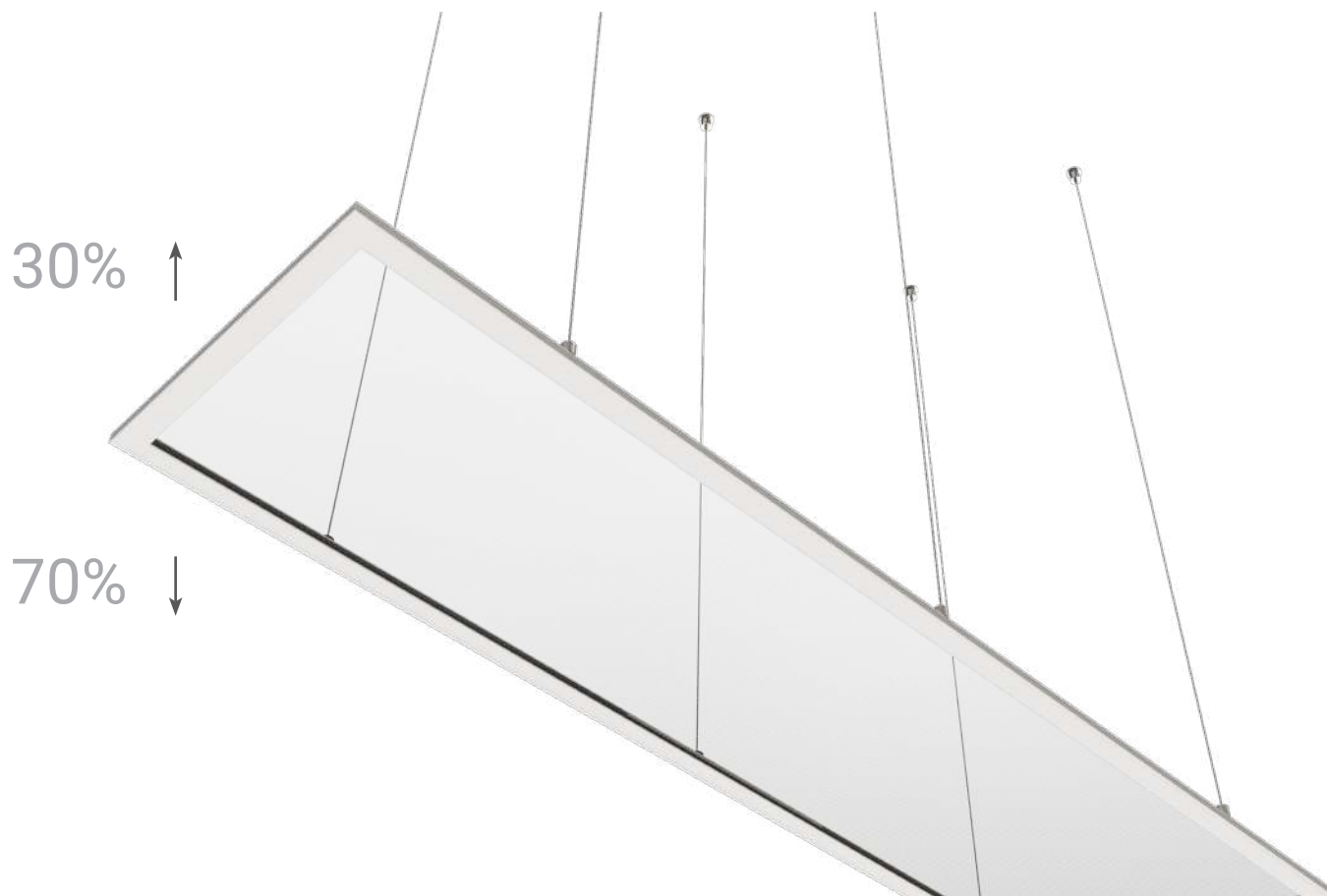

The power cable is one with the suspension cables, therefore invisible.

Light is diffused from the fine white frame to the methacrylate panel. Fractioned by micro incisions on the panel light is directed predominantly downwards. 30% of the light is projected upwards to create a striking effect that adds to any classic or modern environment.

NOTES:

The Translucent Up&Down 30x120 panels are complete with suspension cables and driver integrated in the ceiling rose. Maximum suspension length 150 cm.

DIMMABILITY

Can be used with 0-10V dimmers



SLIMFLUX ACCESSORY

TYPE

Frames for mounting LED panels on ceilings.

CHARACTERISTICS

Make it possible to use SLIMFLUX panels in ceilings where there is no possibility to install recessed panels; frames can hide the drivers.

MATERIALS

LPLAFO60/120: painted sheet metal. Other models in mounting kit: extruded aluminium. White colour.

NB

The LPLAFO60 and LPLAFO120 models are installed using surface fixing brackets. Other models in mounting kit: the frame fixes directly to the surface. Screws and plugs supplied.



Slimflux 60x60: surface mounting with the frame.



art

		L	L1	H	
LPLAFO60	Fully assembled plus model for 60x60 panels	603	603	60	1
LPLAFO120	Fully assembled plus model for 120x30 panels	1203	303	60	1



art

		L	L1	H	
LPLAFO603	Self assembly kit Basic model for 60x60 panels - h 5 cm	600	600	50	40
LPLAFO604	Self assembly kit Basic model for 60x60 - kit to assemble - h 8 cm	600	600	80	25
LPLAFO1203	Self assembly kit Basic model for 30x120 - kit to assemble - h 5 cm	1200	300	50	20
LPLAFO301204	Self assembly kit Basic model for 30x120 - kit to assemble - h 8 cm	1200	300	80	20
LPLAFO601204	Self assembly kit Basic model for 60x120 panels - h 8 cm	1200	600	80	20

SLIMFLUX ACCESSORY



art		L	L1	H	
New	LPLAF060P Self assembly kit Basic model for 60x60 panels	603	603	60	1



(Not suitable for Backlit panels)

art					
	KTLPW1-MS Metal springs kit for recessed installation - 4 pieces				1



art		L	
	LP-SSK Anti-fall safety wire and terminal block	1200	1



art		L	
	FASTCON-30 Terminal block with 27cm wire	270	1



art		L	
	KTLP-SPU Adjustable suspension wires kit	2000	1

FIXTURES FOR REPLACEABLE LAMP

CHOOSE THE MOST SUITABLE LAMP, CHANGE IT WHEN NECESSARY, VARY THE BEAM ANGLE AS REQUIRED...

NEW



PLUS

**DURABLE WALL
ROUND**

NEW



PLUS

**DURABLE WALL
BRICK**

APPLIQUES

DOUBLE EMISSION FOR THESE IP44 WALL LIGHTS

Decorative luminaires with pure lines, to be used with GU10 lamps, available in two colours, it fits all settings, modern or classic.

SUSPENSIONS

Elegant pendants for residential and restaurants. And Catenaria for parties and special occasions!

NEW



PLUS

**DURABLE
SUSPENSION
GU10**



BASIC

**SUSPENSION
E27**



BASIC

CATENARIA



BASIC

CATENARIA

WALK-ON

NEW



PLUS

**DURABLE
WALKABLE IP65**

An easy-to-use luminaire, for the new GU10 Long Life 50,000 hours or any PAR16 in the range, with no need for drivers.

DOWNLIGHTS

NEW



BASIC

DURABLE
ZKR2

NEW



BASIC

DURABLE
ZKR1



BASIC

ZKRR - ORIENTABLE
RECESSABLE RING

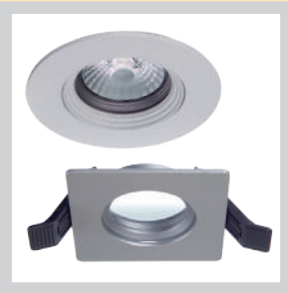

PLUS

ZK4 - RECESSABLE
RING IP65



BASIC

ZK4 - RECESSABLE
RING IP20

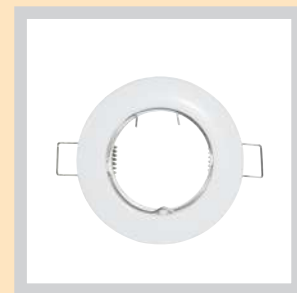

BASIC

ZK4 - RECESSABLE
RING IP20

TRACKLIGHT

NEW



PLUS

DURABLE
TRACK GU10



BASIC

SPOT-V E27

NEW



PLUS

DURABLE
SUSPENSION
GU10

The advantage of easy lamp replacement without the need for technical intervention: much appreciated in retail shops!



Easy with the DuraSmart range!
Smart lamps that make life easier



DuraSmart sources are activated and managed with TUYA APPs, used by the whole world of home automation.



APP:
TUYA SMART
SMART LIFE



Smart
control



Voice
control

WI-FI
Bluetooth
Amazon Alexa
Assistenti Vocali Google



Colou light effects

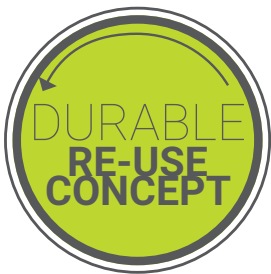

+ DuraSmart = SMART LIFE!

The DURABLE line, luminaires for replaceable light sources, is perfect for taking advantage of the flexibility in light colour, and thus room perception, offered by the DuraSmart line of lamps.

So the pendant on the restaurant table can have cool white light for lunch and warm light for dinner, the spotlights in a shop window can emit light of any colour, for fixed or dynamic settings simply set by a smart phone.



Cool white and warm white light depending on the time of day, to support the correct circadian rhythm.



System compatible with iOS 8.0 or higher; Android 4.3 or higher.

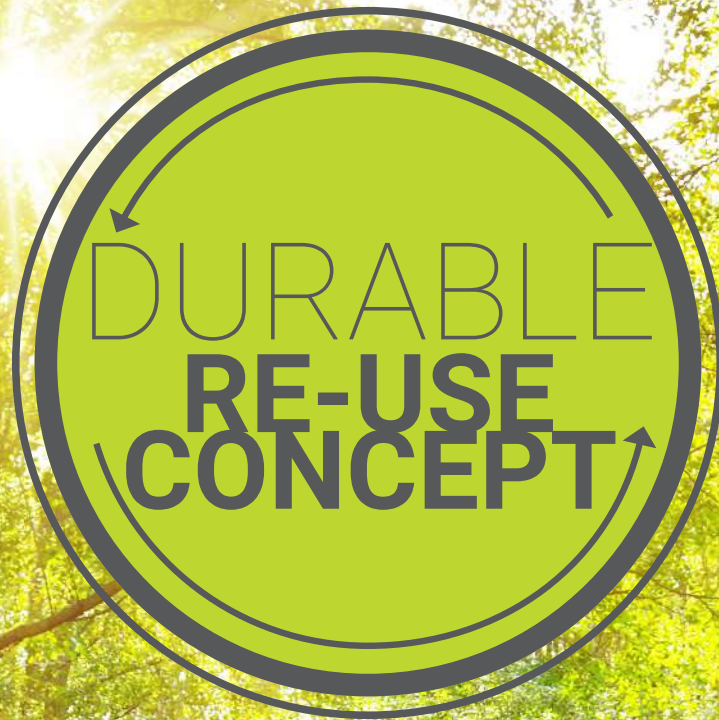

DURABLE

LED light sources have very long lifetimes compared to lamps of the past. Technology now makes it possible to create luminaires complete with light source at previously unthinkable costs, for all kinds of applications.

Alongside these, we want to activate new product lines where you can change the source, so that they last over time....

DURABLE - TRACK SPOT FOR GU10

TYPE

Professional LED projectors for track mounting with GU10 lampholder.

CHARACTERISTICS

Can be used with Eurostandard Plus tracks as well as with other brands': Staff, Nordlux, Nordic, Global, etc.

OPTIC

Can be used with all GU10 lamps in the catalogue: select the desired power and beam opening.

MATERIALS

Die-cast painted aluminium body.

MOUNTING

Onto an electrical track in 3 phases; fixtures equipped with a safety lock to fix to the tracks.



PLUS	220-240V 50/60Hz	IP20	-25° +35°C		G3
------	---------------------	------	---------------	--	----

The luminaire does not include the lamp: choose the most suitable lamp from our range.
For professional use we suggest items 28530LL/28540LL.

art.		Ø	L	L1		8011905	
New DBTR160-W		GU10	60	130	170	290	980535 20
New DBTR160-B		GU10	60	130	170	290	981082 20

MULTI GU10LL

PLUS	220-240V 50/60Hz	Ra>80		50000h L70	IP20	-25° +35°C	G5/ h24	
------	---------------------	-------	--	---------------	------	---------------	------------	--



art.	W		lm	cd	K		Ø	H	8011905	
New 28530LL	5,5	GU10	665	820	3000	38°	50	55	979911	10
New 28540LL	5,5	GU10	700	850	4000	38°	50	55	979928	10

• Minimum Order Quantity

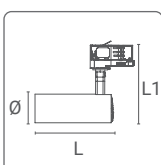

DURASMART 36°



MULTI GU10: 38° - 50°



MULTI 100: 100°



XSPOT: 10°



SIRIUS-P



TRACK MOUNTING FITTING FOR REPLACEABLE LAMP

TYPE

Adjustable fitting complete with adaptor for track mounting and E27 lampholder.

CHARACTERISTICS

Satisfies the needs of those who prefer a track-mounted luminaire for replaceable lamps.

Can be used with Eurostandard Plus tracks as well as with other brands': Staff, Nordlux, Nordic, Global, Nuco etc.

Adjustable from +90° to -90° on the vertical plane and 350° on the horizontal plane.

Suitable for PAR20, PAR30, PAR38, REFLECT LED, A60 lamps: see the list of lamps that can be fitted. Max 30W.

MATERIALS

Die-cast painted aluminium body, white color; steel adjustable arm.

MONTING

Mounting on an electrical track in 3 phases; fixtures equipped with a safety lock to fix to the tracks.

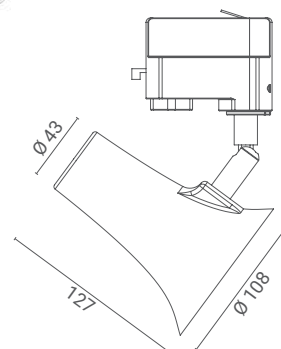

BASIC	IP20	-25° +35°C	G3
-------	------	---------------	----

art.		Ø	L			
SP01-W	E27	108	127	277	8011905 935252	1

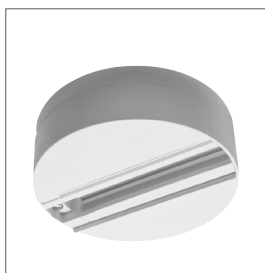

Adapter for surface installations

art			
B60220		8007753 309284	1
B60221		8007753 309277	1

CAN BE USED WITH PAR38 L868W, L868; REFLECTLED: L758WB, L915WB; A60: DA6020W.



DURABLE - PENDANT FOR GU10

TYPE

Pendant luminaire for direct lighting, for replaceable lamp with GU10 socket.

CHARACTERISTICS

Minimal, simple design and precise finishing. Available in different size and colours.

OPTIC

Can be used with all GU10 lamps in the catalogue: select the desired power and beam opening.

MATERIAL

Die-cast painted aluminium body.

NB

Cable length 1,5 m.



PLUS	220-240V 50/60Hz	IP20	-25° +35°C		G3
------	---------------------	------	---------------	--	----

The luminaire does not include the lamp: choose the most suitable lamp from our range. For professional use we suggest items 28530LL/28540LL.



art.			Ø	L	8011905	
New DBSP115-W	<input type="checkbox"/>	GU10	60	150	980573	20
New DBSP115-B	<input checked="" type="checkbox"/>	GU10	60	150	981105	20
New DBSP130-W	<input type="checkbox"/>	GU10	60	300	980559	20
New DBSP130-B	<input checked="" type="checkbox"/>	GU10	60	300	981099	20



art.			Ø	L	8011905	
New DBSP215-W	<input type="checkbox"/>	GU10	60	150	982225	20
New DBSP215-B	<input checked="" type="checkbox"/>	GU10	60	150	982232	20
New DBSP230-W	<input type="checkbox"/>	GU10	60	300	982249	20
New DBSP230-B	<input checked="" type="checkbox"/>	GU10	60	300	982256	20

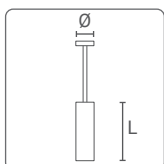

DURASMART 36°



MULTI GU10: 38° - 50°



MULTI 100: 100°



XSPOT: 10°



SIRIUS-P





SUSPENSION CABLES WITH E27 LAMP HOLDER AND CEILING CUP

TYPE

Diverse materials suspension wires with E27 lamp holder and ceiling cup.

CHARACTERISTICS

Minimal, simple design and precise finishing.

MATERIAL

Silicone for white and black versions; metal for other models.

NB

Cable length 2 m.



BASIC	220-240V 50/60Hz	MAX 30W	E27	IP20	G2
-------	---------------------	------------	-----	------	----

art.			Ø	H	8011905	
TN-E27N		E27	85	2000	850692	10
TN-E27B		E27	85	2000	850708	10
TN-E27CR		E27	100	2000	850715	10
TN-E27CU		E27	100	2000	850722	10
TN-E27OT		E27	100	2000	861575	10

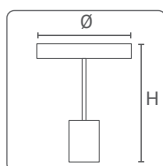

DURABLE - WALL LAMP TONDO IP44

TYPE

Double emission wall light for replaceable lamp with GU10 socket.

CHARACTERISTICS

The design of the fixture sees the positioning of the lamp a few centimetres from the wall allowing the cone of light to develop on the wall in a harmonious way, without excessive glare.

OPTICS

Can be used with all GU10 lamps in the catalogue: select the desired power and beam opening.

MATERIALS

Aluminium body with epoxy coating; glass diffusers.

MONTING

By means of the rear bracket.



PLUS	220-240V 50/60Hz	IP44	-25° +35°C		G3
------	---------------------	------	---------------	--	----

The luminaire does not include the lamp: choose the most suitable lamp from our range. For professional use we suggest items 28530LL/28540LL.

art.			L	L1	H			
New DBAT100-W		GU10	67	93	152	470	8011905 980597	20
New DBAT100-B		GU10	67	93	152	470	981112	20

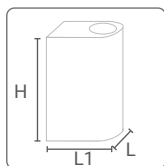

DURASMART 36°



MULTI GU10: 38° - 50°



MULTI 100: 100°



XSPOT: 10°



SIRIUS-P



DURABLE - WALL LAMP BRICK IP44

TYPE

Double emission wall light for replaceable lamp with GU10 socket.

CHARACTERISTICS

The design of the fixture sees the positioning of the lamp a few centimetres from the wall allowing the cone of light to develop on the wall in a harmonious way, without excessive glare.

OPTICS

Can be used with all GU10 lamps in the catalogue: select the desired power and beam opening.

MATERIALS

Aluminium body with epoxy coating; glass diffusers.

MONTING

By means of the rear bracket.



PLUS	220-240V 50/60Hz	IP44	-25° +35°C		G3
------	---------------------	------	---------------	--	----

The luminaire does not include the lamp: choose the most suitable lamp from our range. For professional use we suggest items 28530LL/28540LL.

art.			L	L1	H		8011905	
New DBAQ100-W		GU10	67	95	152	550	980610	20
New DBAQ100-B		GU10	67	95	152	550	981129	20

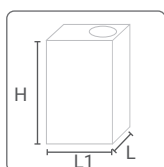

DURASMART 36°



MULTI GU10: 38° - 50°



MULTI 100: 100°



XSPOT: 10°



SIRIUS-P





INGROUND WALK-ON IP67

TYPE

Walk-on fixture for inground installation complete with GU10 lampholder.

CHARACTERISTICS

Complete with steel outer ring and screws, clear glass.

OPTIC

Can be used with all GU10 lamps in the catalogue: select the desired power and beam opening.

MATERIALS

Metal body, brushed steel ring, shockproof IK10 glass screen; plastic sleeve.

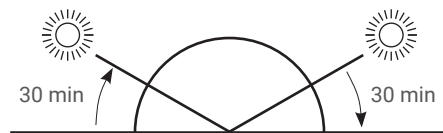
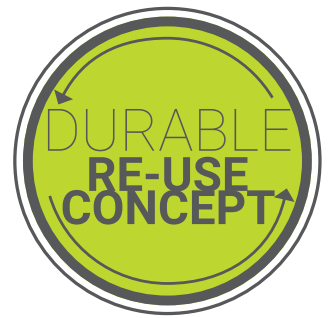

PLUS		220-240V 50/60Hz	IP67	IK10	-20° +35°C		G3
------	--	---------------------	------	------	---------------	--	----

The luminaire does not include the lamp: choose the most suitable lamp from our range. For professional use we suggest items 28530LL/28540LL.

art.		Ø	H		
New DBIN100-0	GU10	110	125	8011905 980627	20

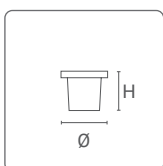

DURASMART 36°



MULTI GU10: 38° - 50°



MULTI 100: 100°



XSPOT: 10°



SIRIUS-P



CATENARIA

TYPE

Long run conductive cable with 24 factory attached lamp holders.

CHARACTERISTICS

Two different models: with lamp holder on the cable or with pendant. Lampholders are fitted with IP44 protection rings.

APPLICATIONS

Widely used for festoons indoor and outdoor garden lighting decoration, patio umbrella lighting, etc. Suggested lamps PING BALL, Color GLS or Stargazer lamp.

NB

Factory prepped outdoor IP44 Schuko socket for Europe, US plug or end prep wiring options for the USA. Cannot be connected in series.

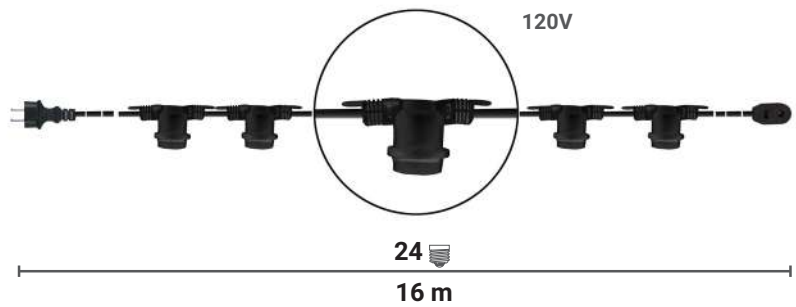
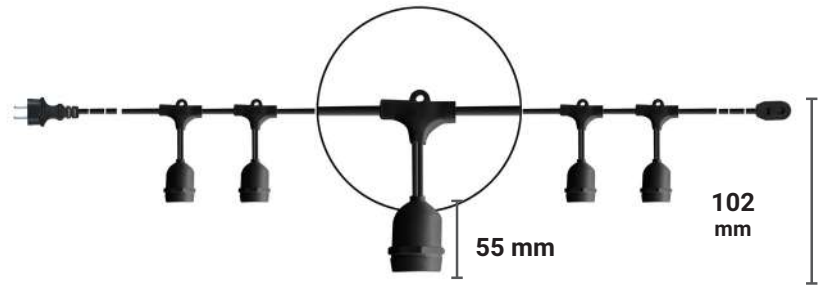

art.	W max	W max Tot	N#		L	8011905	
CLE2724	25	670	24	E27	16 m	843823	4



E26 base: for countries at mains = 120V

CLE2624 *	5	120	24	E26	16 m	43830	4
-----------	---	-----	----	-----	------	-------	---



E26 base: for countries at mains = 120V

CLE2624S *	5	120	24	E26	16 m	976644	4
------------	---	-----	----	-----	------	--------	---

* Available upon order also with GU10 lampholder.

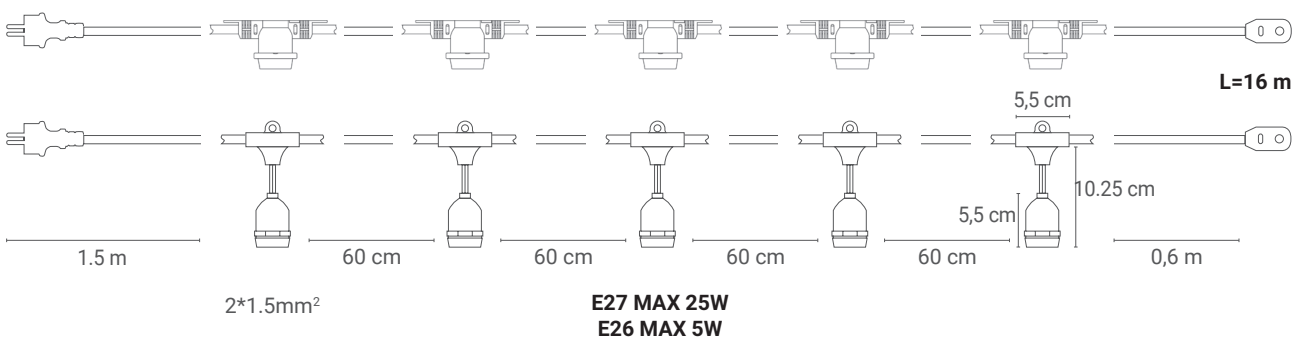

CATENARIA IN SERIES VERSION

TYPE

Long run conductive cable with 15 factory attached lamp holders.

CHARACTERISTICS

Two different models: with lamp holder on the cable or with pendant. The 15 lamp holder sockets can be linked in series. Lampholders are fitted with IP44 protection rings.

APPLICATIONS

Widely used for festoons indoor and outdoor garden lighting decoration, patio umbrella lighting, etc. Suggested lamps PING BALL, Color GLS or Stargazer lamp.

NB

Only Catenaria with 15 lamp holders can be connected in serie with the IP44 Schuko plug and socket on the sides.

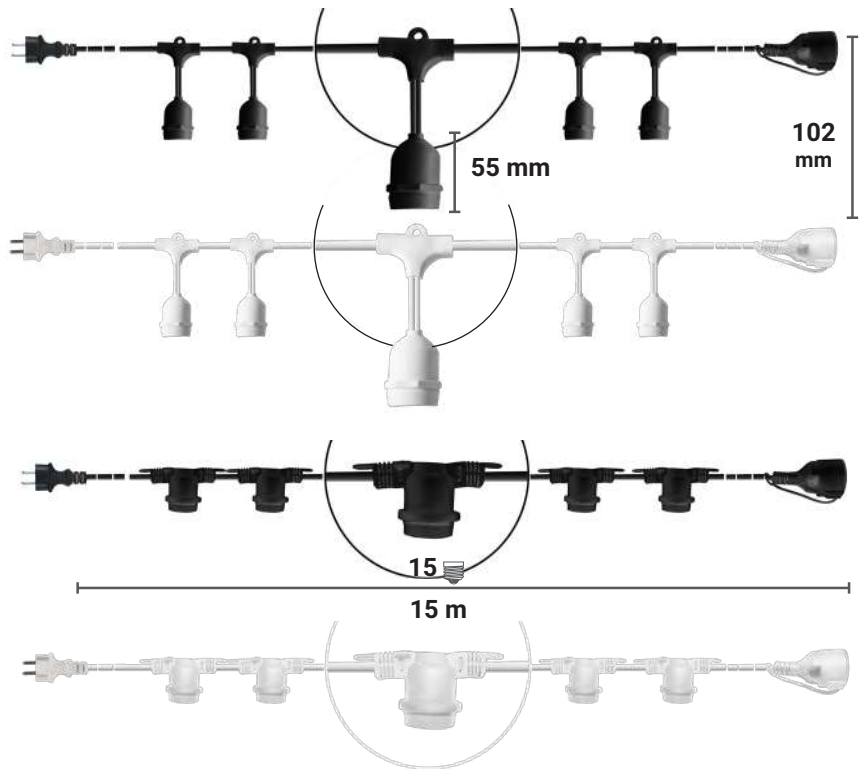

BASIC	220-240V 50/60Hz	IP44	-25° +35°C		G2
-------	---------------------	------	---------------	--	----



Catenaria with 15 lamp holders can be connected consecutively up to a maximum length of 45 metres. Also available in white, perfect for reception areas, weddings etc....

art.	W max	W max Tot	N#		L	8011905	
CLE2715	25	370	15	E27	15 m	856144	4
CLE2715-WH	25	370	15	E27	15 m	950736	4
CLE2715-S	25	370	15	E27	15 m	856168	4
CLE2715-SWH	25	370	15	E27	15 m	950729	4

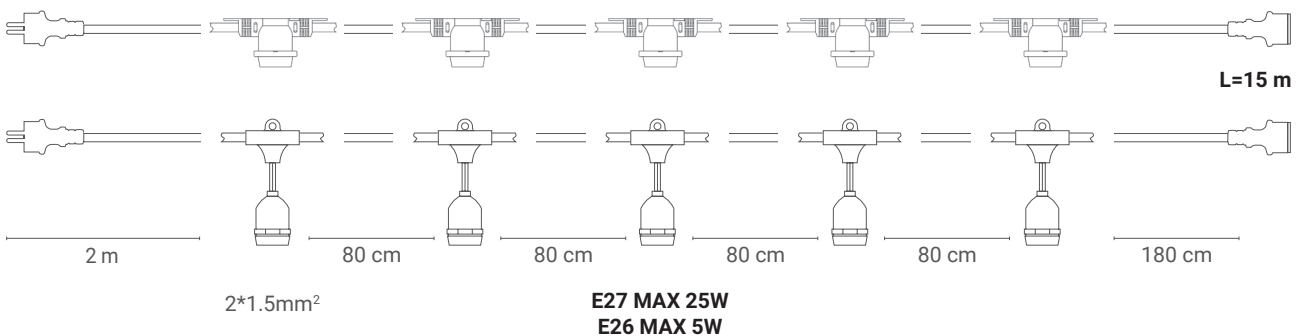

MULTI-OPTIC RECESSED FIXTURE

TYPE

Rectangular recessed fixture for two adjustable GU10 lamps.

CHARACTERISTICS

Widely used in retail installations, it meets the needs of those who prefer a recessed ceiling luminaire with replaceable lamps. It offers the advantage of having both multidirectional and adjustable light beams from +15° to -15° in the vertical plane. Houses PAR16 lamps; compatible with all GU10 lamps in the Duralamp catalogue. Max 30W.

MATERIALS

Body painted aluminium.

MOUNTING

Recessed with the special galvanised aluminium springs. Complete with GU10 lamp holder

Silver colour frame and rings.

ZKR2-ST



Silver colour frame and black rings.

ZKR2-STB



BASIC	220-240V 50/60Hz	IP20 VI IP23 VO		-25° +45°C		G5/ h24
-------	---------------------	--------------------	--	---------------	--	------------

art.		L	L2	H				
New ZKR2-ST		GU10	107	202	110	95x180	8011905 935269	1
New ZKR2-STB		GU10	107	202	110	95x180	981693	1

The luminaire does not include the lamp: choose the most suitable lamp from our range.
For professional use we suggest items 28530LL/28540LL.

The front ring locks the lamp



In this picture with MULTI100 GU10.

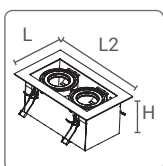

DURASMART 36°



MULTI GU10: 38° - 50°



MULTI 100: 100°



XSPOT: 10°



SIRIUS-P



SINGLE-OPTIC RECESSED FIXTURE

TYPE

Rectangular recessed fixture for one adjustable GU10 lamp.

CHARACTERISTICS

Widely used in retail installations, it meets the needs of those who prefer a recessed ceiling luminaire with replaceable lamps. It offers the advantage of having both multidirectional and adjustable light beams from +15° to -15° in the vertical plane. Houses PAR16 lamps; compatible with all GU10 lamps in the Duralamp catalogue.

Max 15W.

MATERIALS

Body in black painted aluminium with silver colour frame.

MOUNTING

Recessed with the special galvanised aluminium springs. Complete with GU10 lamp holder

Silver colour frame and rings.

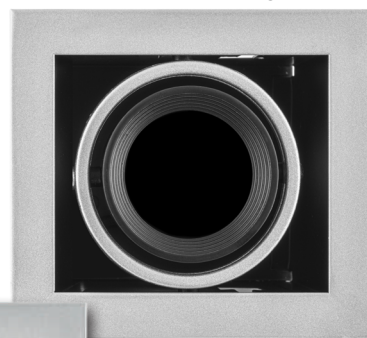

ZKR1-ST

The front ring locks the lamp



Silver colour frame and black ring.

ZKR1-STB

BASIC	220-240V 50/60Hz	IP20		-25° +45°C	G5/ h24
-------	---------------------	------	--	---------------	------------

The luminaire does not include the lamp: choose the most suitable lamp from our range. For professional use we suggest items 28530LL/28540LL.

art.		L	L2	H		8011905	
New ZKR1-ST		GU10	110	110	125	95x95	975845 1
New ZKR1-STB		GU10	110	110	125	95x95	981693 1

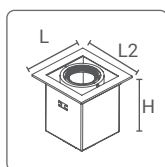

DURASMART 36°



MULTI GU10: 38° - 50°



MULTI 100: 100°



XSPOT: 10°



SIRIUS-P



ZKRR RECESSABLE RING: ADJUSTABLE AND WITH OPTIONAL OPTICS

TYPE

Recessed orientable ring with interchangeable optional optics for MR16, PAR16 lamps and Module.

CHARACTERISTICS

The recessed ring, that allows an orientation of the source of 20°, can be fitted (snap on) with metal optics that can modify the lighting output by offering accent or antiglare solutions.

MATERIALS

Body and optics in painted metal body.

MOUNTING

Equipped with springs for quick installation.

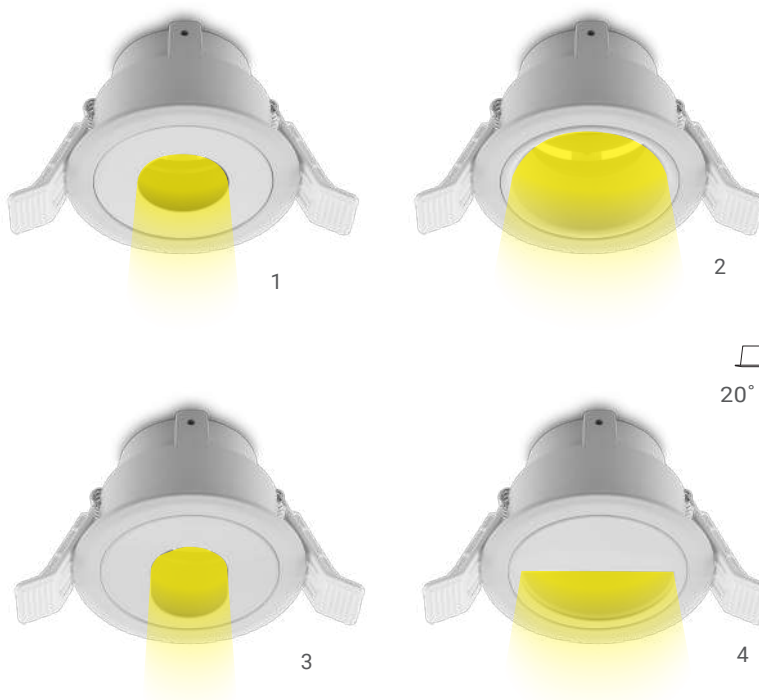

The possibility to easily change the beam using the beam shapers, allows to obtain different effects with the same fixture: ideal in retail spaces.

The ZKRR ring mounts the lamp in a recessed position of 4 cm.

BASIC G5/h24

art.	Ø	H	ⓘ	8011905	📦
ZKRR Adjustable recessed ring - White colour	90	53	78	844059	10

To be completed with the wired lampholders code T053 and T010.

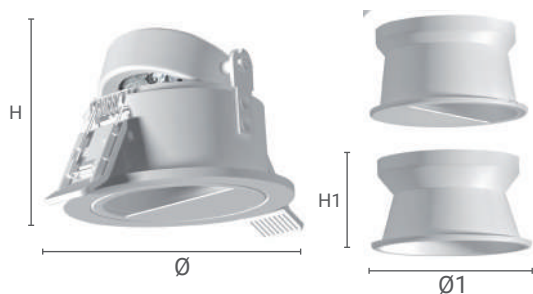

art.	Photo	Ø	Ø1	H	H1	ⓘ	8011905	📦
ZK001 Spot effect beam shaper	1	90	68,5	53	36,7	78	844066	10
ZK002 Wide beam shaper	2	90	68,5	53	36,7	78	844073	10
ZK003 Side beam shaper	3	90	68,5	53	36,7	78	844080	10
ZK004 Wall washer	4	90	68,5	53	36,7	78	844097	10

To be completed with GU10 or GU5.3 lampholder

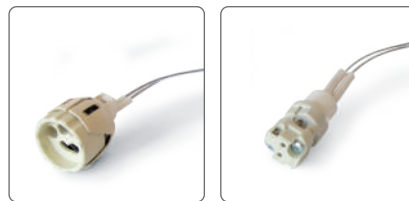
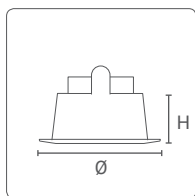

ZK RECESSABLE RINGS: FIXED IP65

TYPE

Recessed orientable ring with interchangeable optional optics for MR16 and PAR16 lamps. IP65 fixed version.

CHARACTERISTICS

The same ring declined in two versions to fulfill different installation needs in the same environments. Ring for recessed installation of MR16 / PAR16 lamps complete with front screen.

MATERIALS

Painted metal body.

MOUNTING

Equipped with springs for quick installation.



IP65



IP65



1



2

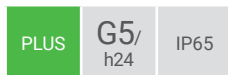

art.	Photo		Ø/L1	H		8011905	
ZKR65QB	1	IP65 Square white ring	90	33	72	836863	10
ZKR65QG	2	IP65 Square gray ring	90	33	72	836870	10



3



4

art.	Photo		Ø/L1	H		8011905	
ZKR65TB	3	IP65 Round white ring	90	33	72	836849	10
ZKR65TG	4	IP65 Round gray ring	90	33	72	836856	10

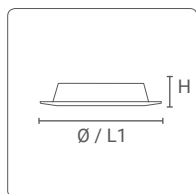

To be completed with GU10 or GU5.3 lampholder



ZK RECESSABLE RINGS: ORIENTABLE IP20

TYPE

Recessed orientable ring with interchangeable optional optics for MR16 and PAR16 lamps. IP20 orientable.

CHARACTERISTICS

The same ring declined in two versions to fulfill different installation needs in the same environments. Ring for recessed installation of MR16 / PAR16 lamps complete with front screen.

MATERIALS

Painted metal body.

MOUNTING

Equipped with springs for quick installation.



ADJUSTABLE 30°
IP20



ADJUSTABLE 30°
IP20



5

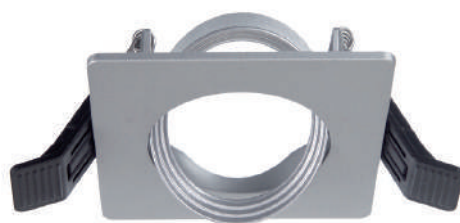

6

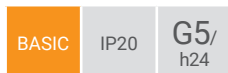

art.	Photo		Ø/L1	H		8011905	
ZKRQB	5	IP20 Square white ring	90	33	72	836825	10
ZKRQG	6	IP20 Square gray ring	90	33	72	836832	10



7

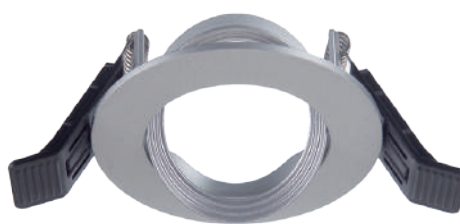

8

art.	Photo		Ø/L1	H		8011905	
ZKRTB	7	IP20 Round white ring	90	33	72	836801	10
ZKRTG	8	IP20 Round gray ring	90	33	72	836818	10

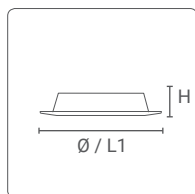

To be completed with GU10 or GU5.3 lampholder



ZK RECESSABLE RING: IP20 FIXED

TYPE

Ring for recessed installation of MR16/PAR16 lamps, IP20.

CHARACTERISTICS

The spring type lamp holder allows this recessed mounting ring to be used with any type of lamp fitted with a front closure.

MATERIALS

White painted metal body.

MOUNTING

Equipped with springs for quick installation. To be completed with the wired lampholders code T053 and T010.

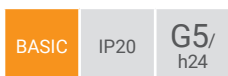

art.	Ø1	Ø	H		8011905	
ZKRTB2	51	78	26	65	861483	10

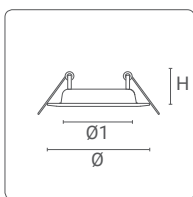

art.	8011905	
T053	Kit lampholder GU5,3 + terminal block	834388 4



art.	8011905	
T010	Kit lampholder GU10 + terminal block	834371 4

• Minimum Order Quantity

INDUSTRIAL

BATTEN



BASIC

FILINO T5

NEW



PRO

BATTEN BT3
IP65

NEW

BASIC

TRIPROOF
S2T IP65



General indoor and outdoor lighting, diffuse light in the three classic sizes. The ST2 STAGNA for two replaceable tubes offers extreme flexibility over time. For use in shops, workshops, garages, cellars....

HIGH BAY



BASIC

HB3
IP65



PRO

HB2 PRO
IP65



PLUS

PANTH SL2
IP65

From the simplest requirements to technical applications in the production as well as retail environments. Luminaires capable of high light output, continuously updated in technology.

LINEAR HIGH BAY

NEW



The BEATRIX Linear HighBay is much more than it looks! Unique aesthetics, enhanced in the 50,000h PRO version, linkable in cascade and with a cool black finish. The BASIC version features natural and warm light colour, ideal in retail and offices.

3000K
4000K

BASIC

HBL BEATRIX
IP65

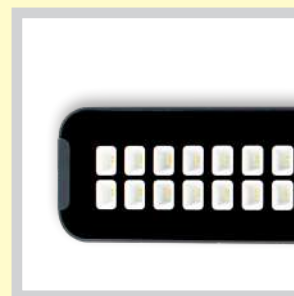

PRO

HBL BEATRIX
IP65

FLOODLIGHT PROJECTORS

NEW



PLUS

PANTH ST
IP65



PLUS

PANTH EVO
IP65



PLUS

PANTH SL2
IP65

PLUS

PANTH EVO
PIR SENSOR
IP44



The range of low-profile projectors has expanded considerably: from 10W to 350W, with a choice of light colour and luminaire body, for any type of indoor or outdoor use.

FILINO T5



30 CM 3000K - 4000K - 6000K

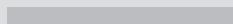

60 CM 3000K - 4000K - 6000K

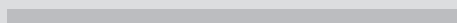

90 CM 3000K - 4000K - 6000K

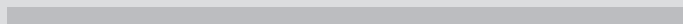

120 CM 3000K - 4000K - 6000K

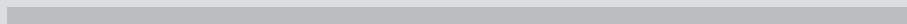

150 CM 3000K - 4000K - 6000K

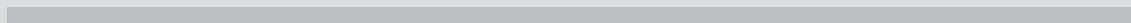

APPLICATIONS

Shelving lights for stores, and under and over cabinets etc.



ANGULAR CONNECTIONS



INSTALLATIONS IN
CONTINUOUS LINES



LIGHT CONTINUITY WITHOUT
INTERRUPTIONS

FILINO T5

TYPE

LED T5 replacement professional undercabinet/ceiling batten light.

CHARACTERISTICS

It attaches to both walls and ceilings using the clip included. Filino T5 batten can be installed in series code KTLRT, up to a maximum of 10 units (20W/23W); 15 units (10W/14W); 20 units 4W. Exceptional light quality & easy fixing with the clips provided. On/off switch on the batten body; Free-wire connection: use the accessory cable with a separate code if a plug is required. Filino T5 batten can be installed in series by joining together the units or using the accessory connection cable, code KTLRT.

MATERIALS

Shockproof plastic body and screen; anti-glare milky white screen. Package complete with free wires, connection, 4.

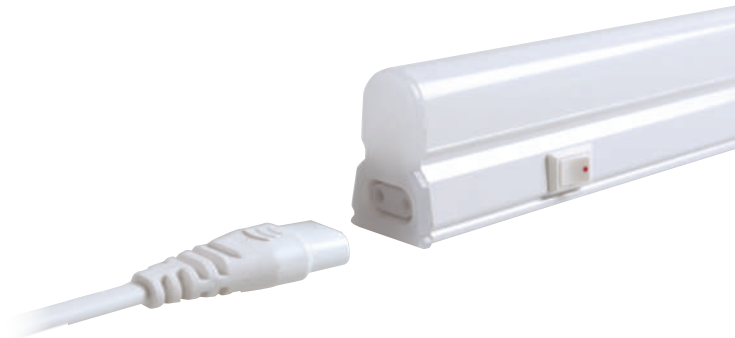

BASIC	220-240V 50/60Hz	Ra>80		20000h L70 B30	IP20	-25° +35°C		G2	Risk Group 0
-------	---------------------	-------	--	-------------------	------	---------------	--	----	-----------------

art.	W	lm	cd	K		L	H	L2		8011905	
LRT530WW	4	300	55	3000	270°	24	39	300	100	936709	10
LRT530NW	4	350	64	4000	270°	24	39	300	100	936716	10
LRT530CW	4	400	74	6000	270°	24	39	300	100	936723	10
LRT560WW	10	850	157	3000	270°	24	39	600	134	910518	10
LRT560NW	10	900	167	4000	270°	24	39	600	134	861100	10
LRT560CW	10	950	186	6000	270°	24	39	600	134	910495	10
LRT590WW	14	1210	223	3000	270°	24	39	900	200	936730	10
LRT590NW	14	1260	232	4000	270°	24	39	900	200	936747	10
LRT590CW	14	1310	241	6000	270°	24	39	900	200	936754	10
LRT5120WW	20	1850	325	3000	270°	24	39	1200	235	910471	10
LRT5120NW	20	1900	335	4000	270°	24	39	1200	235	861117	10
LRT5120CW	20	1950	353	6000	270°	24	39	1200	235	910457	10
LRT5150WW	23	2050	260	3000	270°	24	39	1500	250	936761	10
LRT5150NW	23	2100	369	4000	270°	24	39	1500	250	936778	10
LRT5150CW	23	2150	378	6000	270°	24	39	1500	250	936785	10



Connection wire 15.6 cm

art	L	L2	8011905	
KTLRT	19	15,6	861124	1

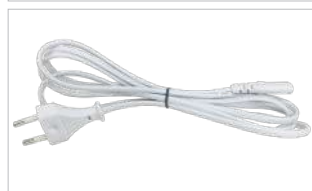
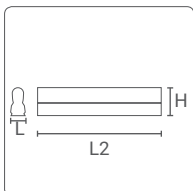

Wire with plug for Reglette Filino T5

art	L2	8011905	
KTLRT-CORD	2000	939946	1

BATTEN BT3

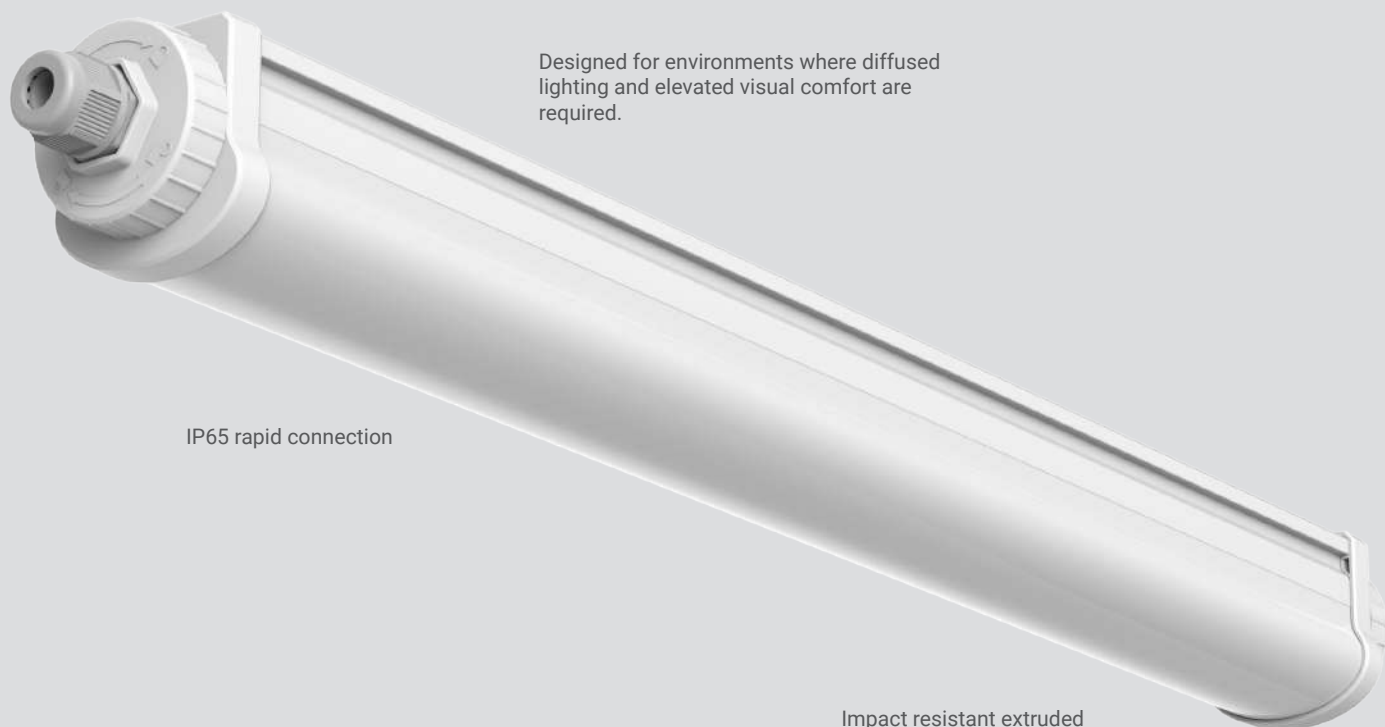

Designed for environments where diffused lighting and elevated visual comfort are required.

IP65 rapid connection

Impact resistant extruded polycarbonate

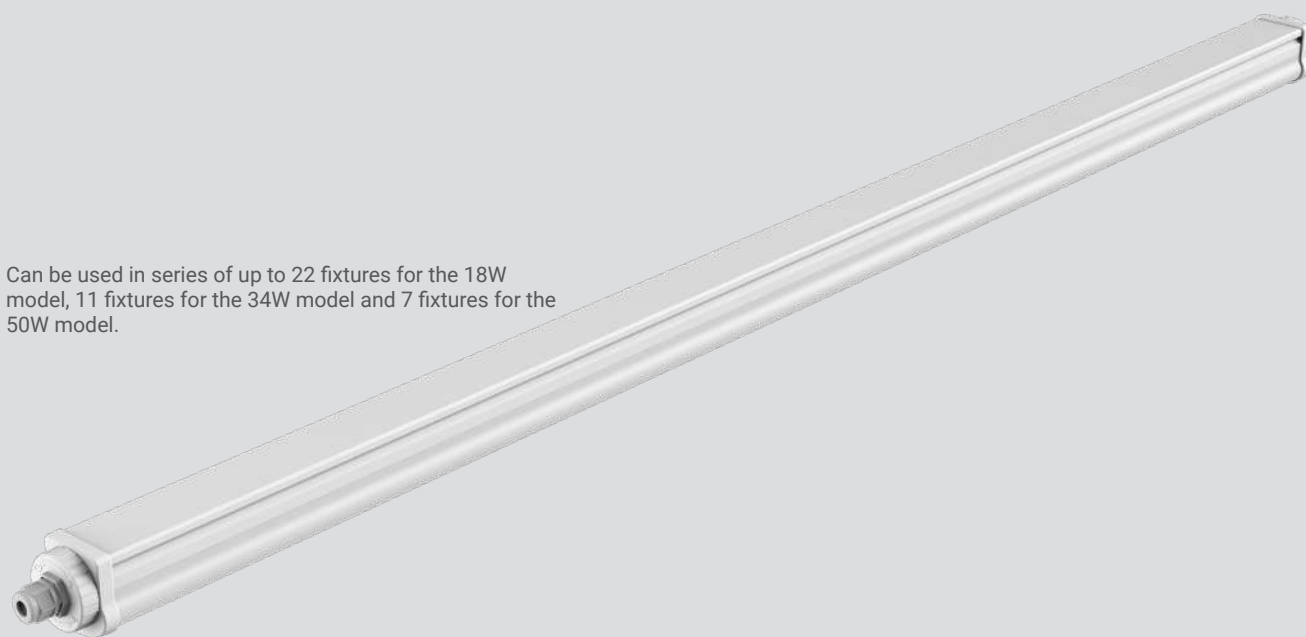

Can be used in series of up to 22 fixtures for the 18W model, 11 fixtures for the 34W model and 7 fixtures for the 50W model.

BATTEN BT3

TYPE

Linear ceiling fixture equipped with high efficiency LED sources. Fitted with a quick spring clamp for connection in series.

CHARACTERISTICS

Quick opening mechanism for wiring. Easy to connect in series thanks to the quick spring clamp supplied.

Can be used in series of up to 22 fixtures for the 18W model, 11 fixtures for the 34W model and 7 fixtures for the 50W model.

MATERIALS

Polycarbonate body: opal polycarbonate screen equipped with internal fins for flow recovery and emission optimisation.

ASSEMBLY

AISI 316 stainless steel 'snap on' bracket to anchor to the ceiling or to be used to suspend the fixture.

Every batten is equipped with brackets.

Adjustable suspension cables available as a separate code.

APPLICATIONS

Supermarkets, car parks, laboratories, warehouses.etc.



PRO	220-240V 50/60Hz	Ra>80		50000h L70 B20	IP65	IK08		G5/ h24		Risk Group 1
-----	---------------------	-------	--	-------------------	------	------	--	------------	--	-----------------

	art.	W	lm	K	PF		L	L1	L2		8011905	
New	BT105W	18	2025	3000	0,9	120°	63	63	600	850	974615	10
New	BT105N	18	2250	4000	0,9	120°	63	63	600	850	976408	10
New	BT105C	18	2250	6000	0,9	120°	63	63	600	850	976392	10
	BT103W	34	4050	3000	0,9	120°	63	63	1200	850	941130	10
	BT103N	34	4300	4000	0,9	120°	63	63	1200	850	941116	10
	BT103C	34	4450	6000	0,9	120°	63	63	1200	850	941123	10
	BT104W	50	6050	3000	0,9	120°	63	63	1500	1100	941161	10
	BT104N	50	6300	4000	0,9	120°	63	63	1500	1100	941147	10
	BT104C	50	6450	6000	0,9	120°	63	63	1500	1100	941154	10



	art.	L	8011905	
	KT-BT1-FS Adjustable suspension wires kit	1000	927653	1

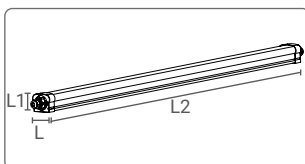

WATERTIGHT S2T IP65



Fixture designed to house
LED Tubes

Housing 2 LED Tubes
not included

WATERTIGHT S2T IP65

TYPE

Linear TRI-PROOF luminaire for surface or suspended installations.

CHARACTERISTICS

Complete with G13 lamp holder for use with 2 replaceable T8 LED tubes.

Quick opening mechanism for wiring.

Easy to connect in series thanks to the quick spring clamp supplied.

MATERIALS

ABS body, PS cover.

MOUNTING

Brackets for ceiling or suspension installation.

APPLICATIONS

Production areas, car parks, laboratories and warehouses.



	art.	Max		L	H	L1	8011905	
New	S2T060L1	10W x 2	G13	108	90	655	987831	8
New	S2T120L1	20W x 2	G13	108	90	1263	987848	8
New	S2T150L1	25W x 2	G13	100	65	1500	987855	8

• Minimum Order Quantity

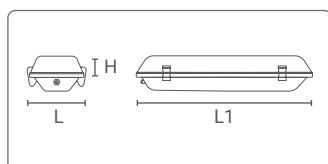

HB3 - HIGH BAY

Minimum thickness;
onboard driver

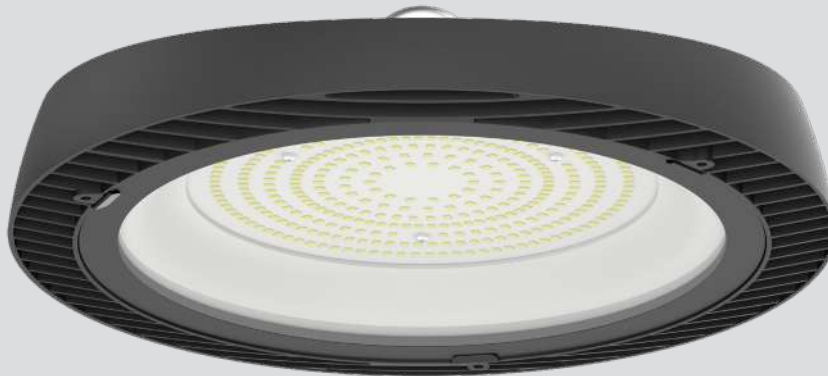

HB3 - HIGH BAY

TYPE

Suspension fixture for installations in large commercial and industrial spaces, equipped with an aluminium reflector with a 110° beam opening.

CHARACTERISTICS

A monoblock body just 4,5cm thick. The entire body of the fixture is laminated to optimise heat dissipation. Integrated power supply, solid structure suitable for use in difficult situations. Free-wire cabling. Replaces discharge lamps up to 400W.

MATERIALS

Powder coated die-cast aluminum body.

APPLICATIONS

Professional lighting ideal for industrial environments and large indoor spaces.

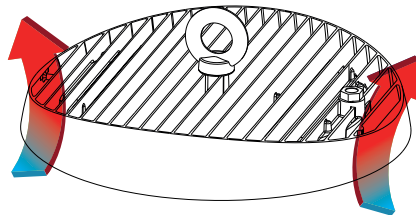

Optimised design to maximise heat exchange



Water flows away along the cooling fins

BASIC	220-240V 50/60Hz	Ra>80		30000h L70 B20	IP65	IK06	-25° +45°C		G3	Risk Group 1
--------------	---------------------	-------	--	-------------------	------	------	---------------	--	-----------	-----------------

art.	W	lm	cd	K	PF		Ø	H	H1		8011905	
HB3-100	100	10000	4900	4000	0,9	110°	270	52	100	1600	941291	1
HB3-150	150	15000	7300	4000	0,9	110°	270	52	100	1635	941307	1
HB3-200	200	20000	9800	4000	0,9	110°	320	51	102	2365	941314	1

	art.		Ø	H	8011905	
	KTHB3-100-PCR	Polycarbonate reflector for HB3-100W/HB3-150W	385	82	960049	1
	KTHB3-200-PCR	Polycarbonate reflector for HB3-200W	414	143	960032	1
	KTHB3-100-R60	Aluminium reflector 60° for HB3-100W/ HB3-150W	385	80	960063	1
	KTHB3-200-R60	Aluminium reflector 60° for HB3-200W	414	140	960056	1
	KTHB3-100-G	Bracket for HB3-100W/ HB3-150W			960025	1
	KTHB3-200-G	Bracket for HB3-200W			960018	1

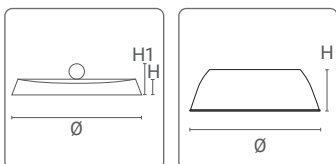

HBL - BEATRIX LINEAR HIGH BAY

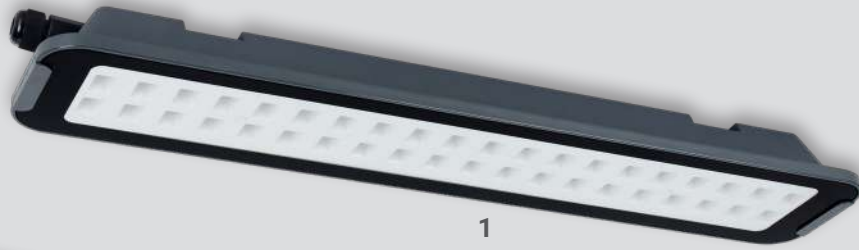

BASIC

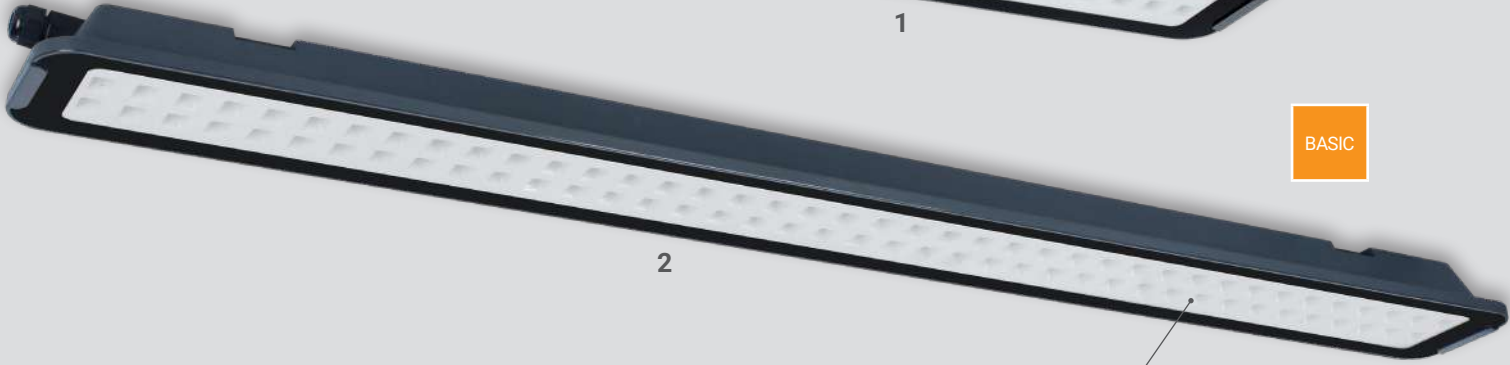

Glass

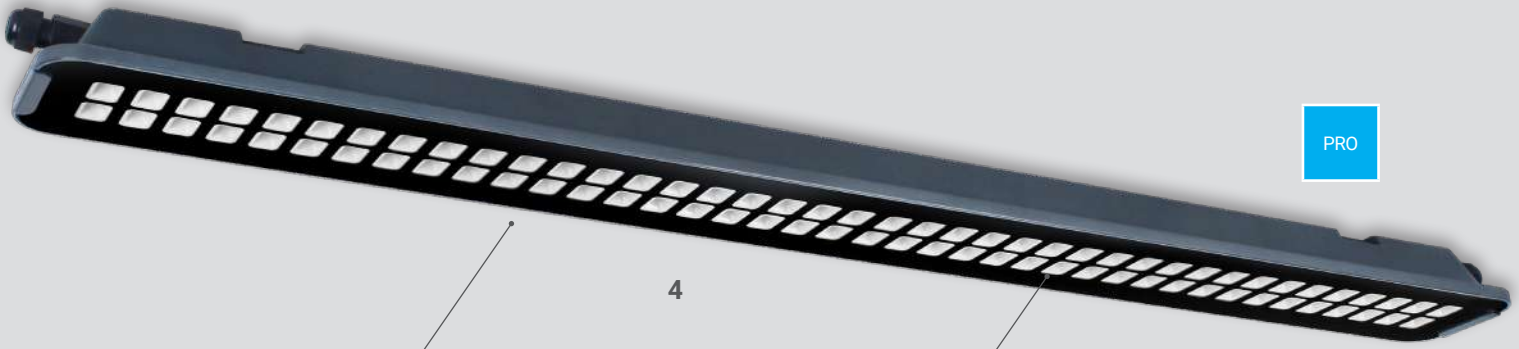

PRO

Tridonic Driver

Glass

HBL PRO can be used in series of up to 10 fixtures for the 40W model and up to 6 fixtures for the 80W model.

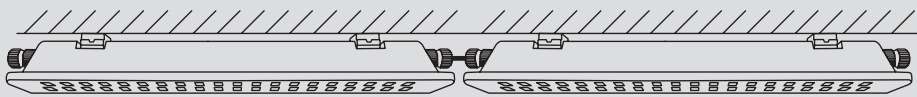
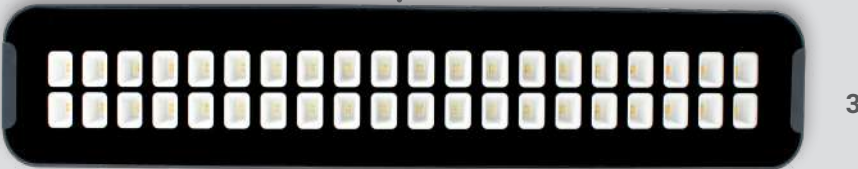

QUICK CONNECTION
WITHOUT TOOLS!



HBL - BEATRIX LINEAR HIGH BAY

TYPE

Suspension fixture for installations in large commercial and industrial spaces; uses SMD technology.

CHARACTERISTICS

Fixtures with single optics to maximise flux. The collection is divided into versions with standard drivers and those with Tridonic drivers. HBL PRO can be used in series of up to 10 fixtures for the 40W model and up to 6 fixtures for the 80W model.

OPTIC

Optical systems composed of micro optics that direct the flux of the LED sources. The LED sources are protected by sealed optics to be used in dusty or dirty environments.

MATERIALS

Extruded PC body; glass front screen.

MOUNTING

Easy cabling using an IP65 connection box attached to the body of the fixture. Wall/ceiling installation with the brackets supplied or suspension mounted. The fixture is equipped with a 1m suspension cable. The separate accessory code for suspension installation includes 3m length cables.

		200-240V 50/60Hz	Ra>80		30000h L70 B20	IP65	IK08	-25° +35°C		G3	Risk Group 1				
art.	photo	W	lm	cd	K		PF	L	L1	H					
New HBL6001W	1	40	3450	2680	3000	60°	0,9	606	120	53.2	1250	990503	6		
HBL6001N	1	40	3600	2800	4000	60°	0,9	606	120	53.2	1250	941321	6		
New HBL12001W	2	80	6850	5650	3000	60°	0,9	1147	120	53.2	2350	990497	6		
HBL12001N	2	80	7200	5900	4000	60°	0,9	1147	120	53.2	2350	941338	6		

		200-240V 50/60Hz	Ra>80		50000h L70 B20	IP65	IK08	-25° +35°C		G5/ h24	Risk Group 1				
art.	photo	W	lm	cd	K		PF	L	L1	H					
HBL6002N	3	40	3600	2800	4000	60°	0,9	606	120	53.2	1250	941345	6		
HBL12002N	4	80	7200	5900	4000	60°	0,9	1147	120	53.2	2350	941352	6		



art.	L		
KT-BHL-SP	Adjustable suspension wires kit	3000 943356	1

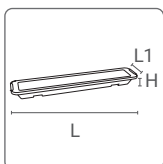

For photometries please consult the website.

PANTH - SL2



200W

150W

100W



PANTH - SL2

TYPE

LED projector for outdoor, indoor and construction site application.

CHARACTERISTICS

Compact dimensions: easy to use and handle. Equipped with fixing bracket, adjustable on the vertical axis. Free wire for professional use (1.5 m long). It can be connected to motion or twilight sensors.

MATERIALS

Grey painted pressed metal body. Completely sealed IP65 driver.

NB

Non Dimming.



THE 200W MODEL CAN ALSO BE USED AS A HIGH BAY: 400 LUX AT 5 METRES HEIGHT.

PLUS	220-240V 50/60Hz	Ra>80		40000h L70	IP65	-25° +35°C		G3	Risk Group 1
------	---------------------	-------	--	---------------	------	---------------	--	----	-----------------

art.	W	lm	cd	K		L	L1	H		8011905	
PANTH-SL1002	100	11000	5380	4000	100°x60°	300	325	92,5	2300	861810	5
PANTH-SL1502	150	13500	6780	4000	100°x60°	360	377	95,5	3000	861841	5
PANTH-SL2002	200	20000	10600	4000	100°x60°	360	480	216	4100	861858	2

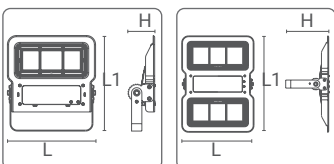

HB2 - HIGH BAY

**FLICKER
FREE** 



**100W 90°
100W 90° DALI
150W 90°
150W 90° DALI**

Optional lens:

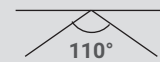
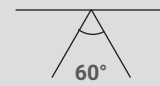

**200W 120°
200W 120° DALI**

Optional lens:

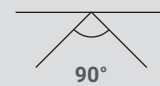
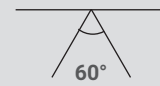

The optional aluminium reflector provides direction the light: ideal in the workplace where video terminals or machines with LCDs are used, the antiglare optic prevents light from being reflected on screens positioned under the fixture.

HB2 - HIGH BAY

TYPE

Suspension fixture for installation in large commercial or industrial spaces; it uses SMD technology. Also available in a DALI version.

CHARACTERISTICS

It is composed of an independent power supply system connected to the body of the fixture with small columns for improved thermal management. The optical unit is integrated into the aluminium body for perfect heat dissipation. The fixture body can be completed with an aluminium or polycarbonate reflector to obtain a different aesthetic and antiglare effect.

OPTIC

The optical system is composed of an array of SMD optimised lenses with a beam opening of 90° for the 100W and 150W and 120° aperture for the 200W.

MATERIALS

Grooved die-cast aluminium for heat dissipation.

ASSEMBLY

Equipped with a mounting ring for suspension installation. For ceiling or wall installation order the accessory code that comprises the bracket and the relative accessories.



To obtain a more attractive aesthetic and reduce glaring the luminaire can be completed with an aluminium or a transparent polycarbonate reflector.

PRO	220-240V 50/60Hz	Ra>80	50000h L70 B20	IP65	IK08	-25° +45°C		G5/ h24	Risk Group 1						
	art.	W	lm	cd	K		PF	Ø	H	H1			8011905		
	HB2-100	100	15000	7200	4000	90°	0,92	260	116	161	2350	929459	1		
	HB2-150	150	23000	11200	4000	90°	0,92	260	116	161	3200	941017	1		
	HB2-200	200	30000	9300	4000	120°	0,92	305	123	168	3800	929893	1		
	HB2-100DALI	100	13000	7200	4000	90°	0,92	262	150	174	3000	938680	1		
	HB2-150DALI	150	20000	11200	4000	90°	0,9	305	150	182	2800	941000	1		
	HB2-200DALI	200	30000	9300	4000	120°	0,92	305	123	168	3500	933180	1		

HB2 HIGH BAY: flux and dimensional data being updated: greater efficiency and compactness.

art.		Ø		art.		Ø	H	
	New KTHB2-100-LENS60 Lens HB2- 100W - 150W - 60°	196	1		KTHB2-100-PCR Polycarbonate reflector for HB2-100W - 150W - 200W	380	122	1
	New KTHB2-100-LENS110 Lens HB2- 100W - 150W - 110°	196	1		KTHB2-100-R Aluminium reflector for HB2- 100W - 150W - 200W	380	122	1
	New KTHB2-200-LENS60 Lens HB2-200W - 60°	242	1		KTHB2-100-F Bracket for HB2-100W 150W - 200W	127	1	
	New KTHB2-200-LENS90 Lens HB2-200W - 90°	242	1					

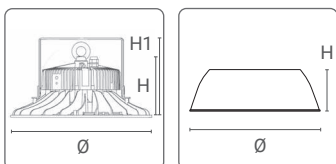

For photometries please consult the website.

PANTH ST

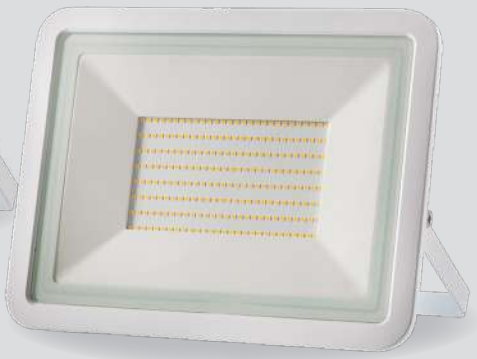

High power items are equipped with a GORE-TEX® valve to compensate for pressure variations due to thermal changes and to prevent the formation of condensation in the fixture.

PANTH ST

TYPE

High power, ultra-thin LED projector; can be used outdoor and indoor.

CHARACTERISTICS



It can be connected to motion or twilight sensors.



MATERIALS

Painted diecast aluminium. Black and white colour.

NB

Free wire for professional use. Models from 100W upwards are equipped with a compensation valve.

BASIC	220-240V 50/60Hz	Ra>80		20000h L70 B30	IP65	-25° +35°C		G2	Risk Group 1
-------	---------------------	-------	---	-------------------	------	---------------	---	----	-----------------

art.		W	lm	cd	K	PF		L	H	L1			
New	PANTH-STWH10N	<input type="checkbox"/>	10	800	350	4000	0,9	120°	103	83	26	185	5•
New	PANTH-STWH10C	<input type="checkbox"/>	10	800	350	6500	0,9	120°	103	83	26	185	5•
New	PANTH-STWH20N	<input type="checkbox"/>	20	1600	650	4000	0,9	120°	121	95	26	320	5•
New	PANTH-STWH20C	<input type="checkbox"/>	20	1600	650	6500	0,9	120°	121	95	26	320	5•
New	PANTH-STWH30N	<input type="checkbox"/>	30	2400	950	4000	0,9	120°	160	123	30	610	5•
New	PANTH-STWH30C	<input type="checkbox"/>	30	2400	950	6500	0,9	120°	160	123	30	610	5•
New	PANTH-STWH50N	<input type="checkbox"/>	50	4000	1500	4000	0,9	120°	206	160	31,5	870	10
New	PANTH-STWH50C	<input type="checkbox"/>	50	4000	1500	6500	0,9	120°	206	160	31,5	870	10
New	PANTH-STWH100N	<input type="checkbox"/>	100	8000	3400	4000	0,9	120°	270	210	35	1410	10
New	PANTH-STWH100C	<input type="checkbox"/>	100	8000	3400	6500	0,9	120°	270	210	35	1410	10
New	PANTH-STWH150N	<input type="checkbox"/>	150	12000	5100	4000	0,9	120°	330	250	35	2790	5
New	PANTH-STWH150C	<input type="checkbox"/>	150	12000	5100	6500	0,9	120°	330	250	35	2790	5
New	PANTH-STWH200N	<input type="checkbox"/>	200	16000	6800	4000	0,9	120°	388	288	36	4270	5
New	PANTH-STWH200C	<input type="checkbox"/>	200	16000	6800	6500	0,9	120°	388	288	36	4270	5
New	PANTH-STWH250N	<input type="checkbox"/>	250	25000	8800	4000	0,9	120°	445	334	45,5	4270	4
New	PANTH-STWH250C	<input type="checkbox"/>	250	25000	8800	6500	0,9	120°	445	334	45,5	4270	4
New	PANTH-STWH350N	<input type="checkbox"/>	350	35000	12000	4000	0,9	120°	490	370	49	6000	2
New	PANTH-STWH350C	<input type="checkbox"/>	350	35000	12000	6500	0,9	120°	490	370	49	6000	2

• Minimum Order Quantity

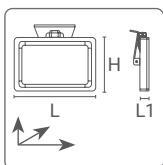

PANTH ST



High power items are equipped with a GORE-TEX® valve to compensate for pressure variations due to thermal changes and to prevent the formation of condensation in the fixture.

PANTH ST

BASIC	220-240V 50/60Hz	Ra>80		20000h L70 B30	IP65	-25° +35°C		G2	Risk Group 1
-------	---------------------	-------	--	-------------------	------	---------------	--	----	-----------------

art.		W	lm	cd	K	PF		L	H	L1		
PANTH-ST10W		10	800	320	3000	0,9	120°	103	83	26	185	5 •
PANTH-ST10N		10	850	340	4000	0,9	120°	103	83	26	185	5 •
PANTH-ST10C		10	850	340	6500	0,9	120°	103	83	26	185	5 •
PANTH-ST20W		20	1600	600	3000	0,9	120°	121	95	26	320	5 •
PANTH-ST20N		20	1600	660	4000	0,9	120°	121	95	26	320	5 •
PANTH-ST20C		20	1600	660	6500	0,9	120°	121	95	26	320	5 •
PANTH-ST30W		30	2400	890	3000	0,9	120°	160	123	30	610	5 •
PANTH-ST30N		30	2400	950	4000	0,9	120°	160	123	30	610	5 •
PANTH-ST30C		30	2400	950	6500	0,9	120°	160	123	30	610	5 •
PANTH-ST50W		50	4000	1400	3000	0,9	120°	206	160	31,5	870	10
PANTH-ST50N		50	4000	1540	4000	0,9	120°	206	160	31,5	870	10
PANTH-ST50C		50	4000	1540	6500	0,9	120°	206	160	31,5	870	10
PANTH-ST100W		100	8000	3100	3000	0,9	120°	270	210	35	1410	10
PANTH-ST100N		100	8000	3300	4000	0,9	120°	270	210	35	1410	10
PANTH-ST100C		100	8000	3300	6500	0,9	120°	270	210	35	1410	10
PANTH-ST150W		150	12000	4700	3000	0,9	120°	330	250	35	2790	5
PANTH-ST150N		150	12000	5000	4000	0,9	120°	330	250	35	2790	5
PANTH-ST150C		150	12000	5000	6500	0,9	120°	330	250	35	2790	5
New PANTH-ST200N		200	16000	6510	4000	0,9	120°	388	288	36	4270	5
New PANTH-ST200C		200	16000	6510	6500	0,9	120°	388	288	36	4270	5
PANTH-ST250W		250	22000	8200	3000	0,9	120°	445	334	45,5	4270	4
PANTH-ST250N		250	25000	8200	4000	0,9	120°	445	334	45,5	4270	4
PANTH-ST250C		250	25000	8200	6500	0,9	120°	445	334	45,5	4270	4
New PANTH-ST350N		350	35000	11000	4000	0,9	120°	490	370	49	6000	2
New PANTH-ST350C		350	35000	11000	6500	0,9	120°	490	370	49	6000	2

• Minimum Order Quantity

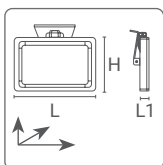

PANTH EVO



50W



10W



20W



30W

DIFFERENT MOUNTING OPTIONS

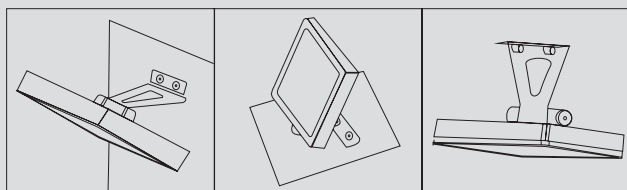

PANTH EVO

TYPE

LED projector 'minimal design' for outdoor and indoor applications.

CHARACTERISTICS

It can be connected to motion or twilight sensors.

OPENING/BEAM

120°

MATERIALS

Painted die-cast metal body.

NB

Free wire for professional use (1 m long).



PLUS	220-240V 50/60Hz	Ra>80		50000h L70 B20	IP65	-25° +35°C		G5/ h24	Risk Group 1
------	---------------------	-------	--	-------------------	------	---------------	--	------------	-----------------

Z	1	****
---	---	------

Emergency fixture with a centralised power supply for emergency lighting.

art.	W	lm	cd		K	PF		L	H	L1			
PANTH-B10N	10	900	350		4000	0,94	120°	116	82	23	205	849818	30
PANTH-WH10W	10	900	350		3000	0,94	120°	116	82	23	205	862671	30
PANTH-WH10N	10	900	350		4000	0,94	120°	116	82	23	205	855482	30
PANTH-B20N	20	1850	700		4000	0,94	120°	147	103	29	360	849825	20
PANTH-WH20W	20	1850	700		3000	0,94	120°	147	103	29	360	862664	20
PANTH-WH20N	20	1850	700		4000	0,94	120°	147	103	29	360	855505	20
PANTH-B30N	30	2650	950		4000	0,98	120°	189	133	29	580	849832	20
PANTH-WH30W	30	2900	950		3000	0,98	120°	189	133	29	580	862657	20
PANTH-WH30N	30	3000	950		4000	0,98	120°	189	133	29	580	855529	20
PANTH-B50N	50	4500	1600		4000	0,96	120°	221	155	34	820	849849	10
PANTH-WH50W	50	5000	1600		3000	0,96	120°	221	155	34	820	862640	10
PANTH-WH50N	50	5200	1600		4000	0,96	120°	221	155	34	820	855543	10

ADJUSTABLE ON THE HORIZONTAL AXIS

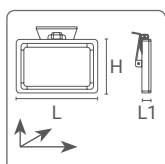

L = 100cm

PANTH EVO PIR SENSOR



50W



30W



Adjustable ambient lighting

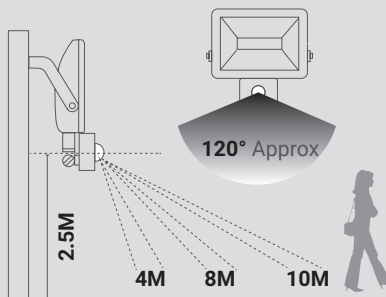
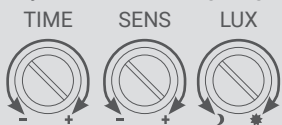

FOR SAFETY AND ENERGY SAVING

PANTH EVO PIR SENSOR

TYPE

LED projector 'minimal design' for outdoor and indoor applications with PIR sensor.

CHARACTERISTICS

Twilight and movement sensor: 10 meters detection range.

OPENING/BEAM

120°

MATERIALS

Painted diecast aluminium. Black colour.

NB

Free wire for professional use (1 m long).

PIR SPECS:

Ambient lighting: 3-2000LUX (adjustable)

Switch on time: min: 10sec÷3sec

Max: 7min÷3min

Installation height: 1.8m÷2.5m

Motion Detection Speed: 0.6~1.5m/s

Detection distance: Max.10m (<24°C ta)



PLUS	220-240V 50/60Hz	Ra>80		25000h L70 B20	IP44	-25° +40°C		G3	Risk Group 1
------	---------------------	-------	--	-------------------	------	---------------	--	----	-----------------

art.	W	lm	cd	K		L	L1	H	H1	8011905	
PANTH-B30NS	30	2650	950	4000	120°	190	29	135	210	855789	20
PANTH-B50NS	50	4500	1600	4000	120°	221	34	155	230	855833	10

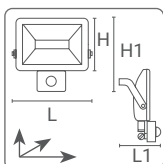

OUTDOOR



PLUS

INGROUND WALK-ON
FITTING IP67



BASIC

SPIKE LED
IP67

White walkable light and white garden light as a freestanding marker.
All with 12V safety.

DECORATIVE FIXTURES

Decorative luminaires, wall-mounted or recessed, for indoor and outdoor.



BULKHEAD
T&O - IP65

BASIC/PRO



PLAFO T2
IP40

BASIC



SEGNASENTIERO
IP65

BASIC



ZOE
IP54

BASIC

FACADE PROJECTORS

NEW



PRO

**MINILINI
IP65**

MINILINI, the linear outdoor lighting from 30 cm to 120 cm, now available with two beam angles, 110° and asymmetric 36°x80°. A quality product for important projects.



PRO

**JAZZ
IP65**

Jazz, a projector with narrow optics for more precise lighting, is made of powder-coated anodised aluminium. For outdoor and underwater

PROJECTORS

Outdoor and underwater DMX-controlled SUBAQ RGB projectors.



PLUS

**SUBAQ RGB
IP68**

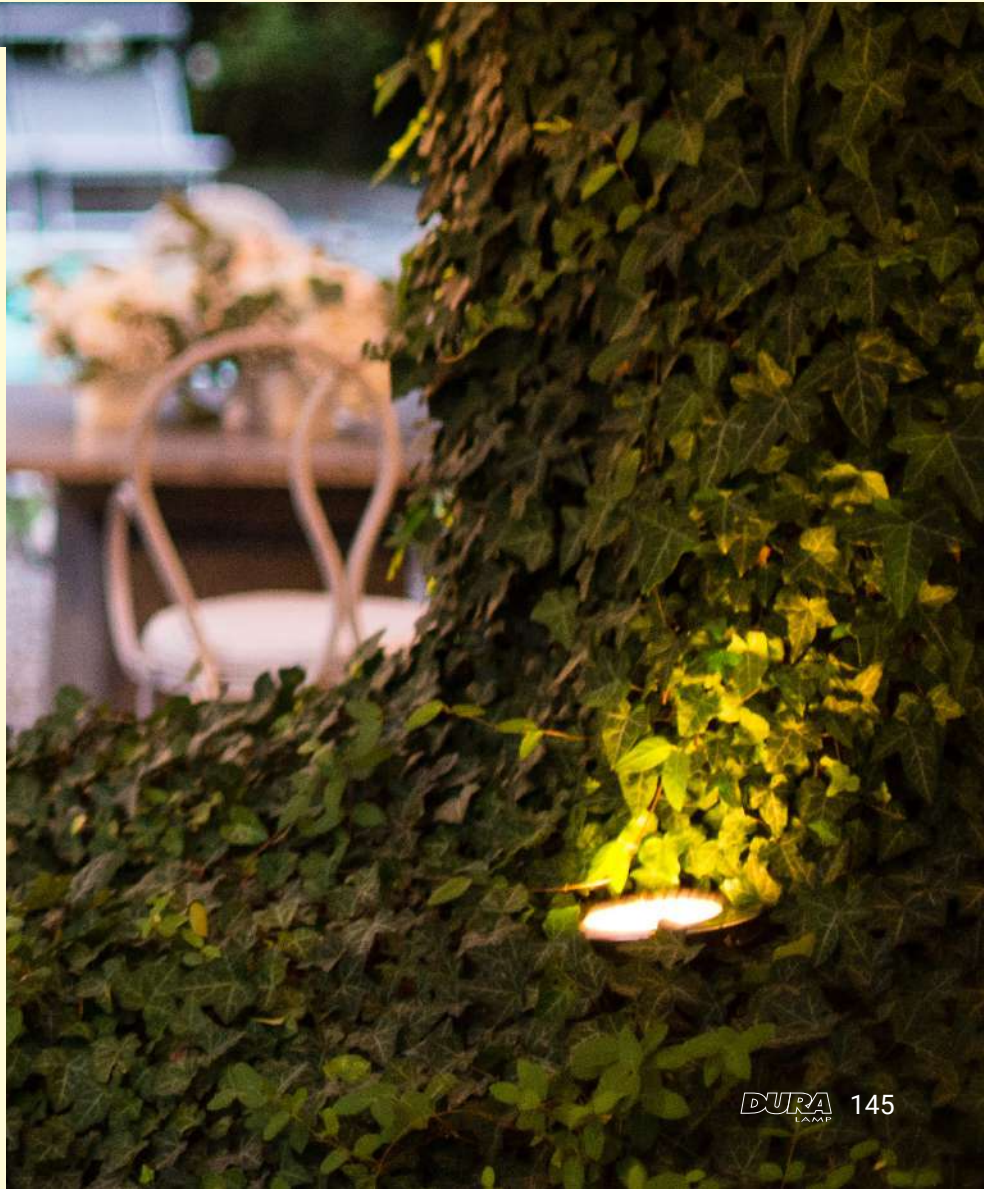

MINILINI IP65



MINILINI allow to create a continuous line of light.



The IP65 wiring is located underneath the luminaire.

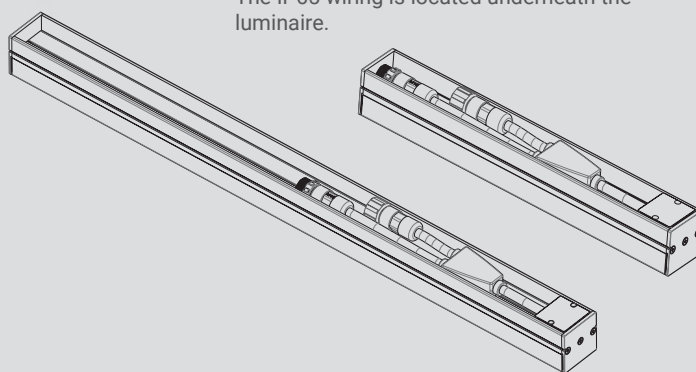

MINILINI IP65

TYPE

Mains voltage architectural linear projector for surface mounted installation.

CHARACTERISTICS

It is constructed from extruded aluminium with an opal polycarbonate cover and is rated IP65 making it suitable for exterior environments: 40 mm wide and 295 or 585 mm long and available in various beam angles and wattages.

Accessories include a selection of fixed and angled surface mounting brackets providing installation uniformity or adjustable brackets for further flexibility.

MINILINI is complete with integrated protection from voltage spikes.

DIMMABILITY

230V: Dimmable 10-100%; TRIAC Leading edge

CONNECTIONS

Maximum connection length: see table.

ASSEMBLY

Choice of surface mounting brackets with different fixed angles - 15°, 30°, 45° - or with adjustable brackets of different heights to be ordered with separate codes.

BINNING

ANSI/SDCM: 2 step.
2700K - 3000K - 3500K



120° opening
36°x80° asymmetrical lens



Driver on board

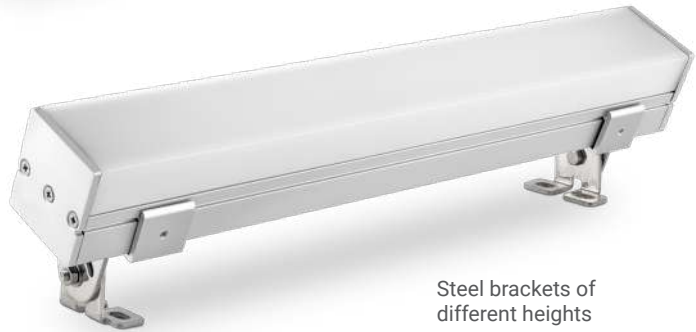

Steel brackets of different heights

Converter Wiring Diagram

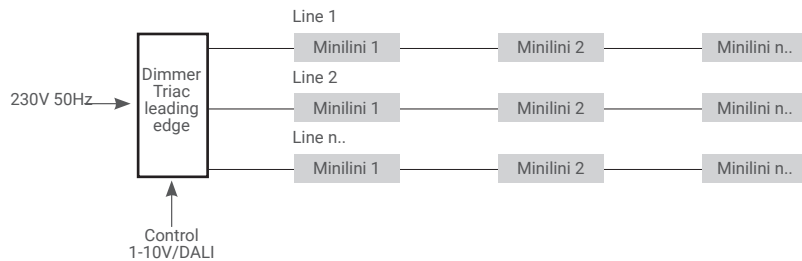

MINILINI CONFIGURATIONS + CONNECTION TABLE

POWER	WATT SET	Modules size	Max N# of modules	Max length each line*	Max W power
4W	1x4W	30,1cm	72	20,4m	288W
8W	1x8W	30,1cm	36	10,2m	288W
8W	2x4W	59,1cm	36	21m	288W
16W	1x16W	30,1cm	18	5,1m	288W
16W	2x8W	59,1cm	18	10,5m	288W
32W	2x16W	59,1cm	9	5,1m	288W
64W	4x16W	114,6cm	4	5,1m	288W

MINILINI IP65

PRO	220-240V 50/60Hz	Ra>90	50000h L70 B20	IP65		-25° +35°C		G5/ h24	Risk Group 1
-----	---------------------	-------	-------------------	------	--	---------------	--	------------	-----------------

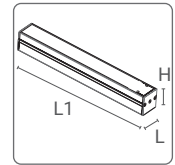

art.	W	lm	cd	K	PF		L	H	L1		
New MNLO16EP12WGC30E	16	850	640	3000	0,95	36°x80°	40	40	295	967598	1
New MNLO16EP12WGC40E	16	880	665	4000	0,95	36°x80°	40	40	295	967581	1
MNLO16EP12FLO30E	16	695	240	3000	0,95	110°	40	40	295	955311	1
MNLO16EP12FLO40E	16	720	250	4000	0,95	110°	40	40	295	955328	1
New MNLO32EP24WGC30E	32	1700	1285	3000	0,95	36°x80°	40	40	585	967574	1
New MNLO32EP24WGC40E	32	1760	1330	4000	0,95	36°x80°	40	40	585	967567	1
MNLO32EP24FLO30E	32	1390	480	3000	0,95	110°	40	40	585	955335	1
MNLO32EP24FLO40E	32	1440	495	4000	0,95	110°	40	40	585	955342	1
New MNLO64EP48WGC30E	64	3400	2570	3000	0,95	36°x80°	40	40	1200	967543	1
New MNLO64EP48WGC40E	64	3520	2660	4000	0,95	36°x80°	40	40	1200	967550	1

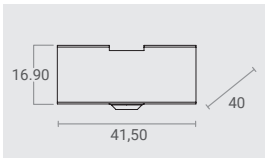

art	Description	
KTMNLBKTVERT	304 steel surface mounting bracket for vertical positioning (10 pieces). We recommend using 2 for every module.	1

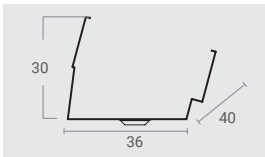

art	Description	
KTMNLBKT15	304 steel surface mounting bracket with an angle of 15° (10 pieces).	1

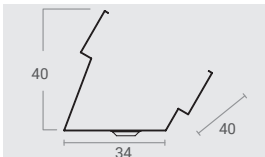

art	Description	
KTMNLBKT30	304 steel surface mounting bracket with an angle of 30° (10 pieces).	1

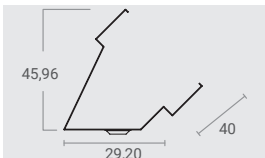

art	Description	
KTMNLBKT45	304 steel surface mounting bracket with an angle of 45° (10 pieces).	1

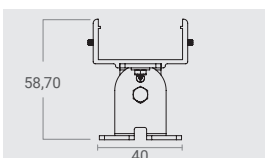

art	Description	
ORDEV1	35 mm surface mounting bracket, can swivel 90° in both directions (2 pieces).	1



JAZZ PROJECTORS IP65



Precision multifaceted optics.



25° - 60°
available upon
request

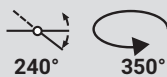

JAZZ PROJECTORS IP65

TYPE

LED projector with COB technology for outdoor spot lighting.

CHARACTERISTICS







Sleek design that can be used in any setting; adjustable to 240°. Projector with base with integrated driver.

OPTICS

LED Chip on Board , high efficiency, Ra 85. Adjustable from 0° to 240° on the vertical axis and 350° on the horizontal axis.

MATERIALS

Anthracite grey colour, powder coated anodised aluminium body.

PRO	220-240V AC		Ra>85	50000h L70 B20	-25° +35°C		G5/h24	Risk Group 1							
art.	W	lm	cd	K	PF		L	H	L2	Ø		 8011905			
JZ03BNW *	30	2700	4100	4000	0,9	40°	156	210	95	100	1700	862442	1		
JZ03BWW	30	2800	3250	3000	0,9	55°	156	210	95	100	1700	934170	1		

* Subject to minimum order.

Dimmable (TRIAC, LEADING EDGE). Dimmers' list on www.duralamp.it

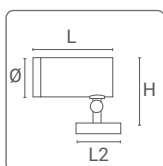

SPIKE LED

TYPE

Garden spike LED light: classic use with modern technology.

CHARACTERISTICS

Diffused light from a smaller point of origin: only 128mm above ground. Complete with an anti-glare cover.

MATERIALS

Die-cast aluminium body; epoxy painted metal body and spike.

NB

Do not use with drivers for halogen lamps; 12V AC/DC power supply not included.



BASIC	12V AC/DC	Ra>80		25000h L70 B30	IP67	IK10	-25° +35°C		G3	Risk Group 1
-------	-----------	-------	--	----------------	------	------	------------	--	----	--------------

art.	W	lm	cd	K	PF		Ø	L			
LND0760NW	7	430	434	4000	0,70	60°	56	290	290	8011905	50

Can be used with Duralamp's driver for LEDs: SLD-50-24 MAX 3 light fixtures

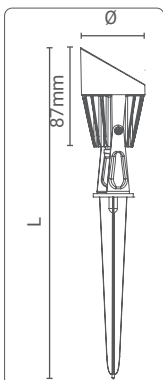



SPIKE LED IP67

Orientable and almost invisible

OUTDOOR AND UNDERWATER PROJECTORS

ADJUSTABLE 180° FOR SWIMMING POOLS AND FOUNTAINS

15W



18W



RGB VERSION CONTROLLED VIA DMX

RGB version controlled via DMX with integrated electronic controller: we recommend the WALL TOUCH panel, code ZKTPC-RGBW.

Without a control signal, the device goes into an automatic mode and cycles a sequence of pre-set colours.

SUBAQ

TYPE

IP68 projector for underwater and outdoor applications.

CHARACTERISTICS



Completely sealed projector for use in swimming pools and fountains. Swivel body mounted on a bracket and complete with surface fixing plate.
Free wires connection,.





MATERIALS

AISI 316 Stainless steel body and polycarbonate cover. Material resistant to chlorine and swimming pool additives.

NB

Operating Voltage: 12V, 50Hz LED driver not included. Do not use with dimmers. Max depth underwater: 5.0 mtr.

PLUS	12V DC	Ra>80		20000h L70	IP68	-25° +35°C		G3	Risk Group 1
------	-----------	-------	---	---------------	------	---------------	---	----	-----------------

art.	W	Im		Ø	H	 8011905	
12PR1530RGB	15	 free wires	30°	147	141	850586	20
12PR1860RGB	18	 free wires	60°	147	141	850593	20

Preset DMX address 1
Can be used with Duralamp driver for LED
SLD-50-12 MAX 1 fitting

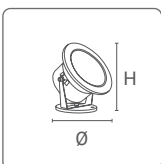

INGROUND WALK-ON IP67 FITTING



60°



14W

Ø94mm



36°



20W

Ø134,8mm

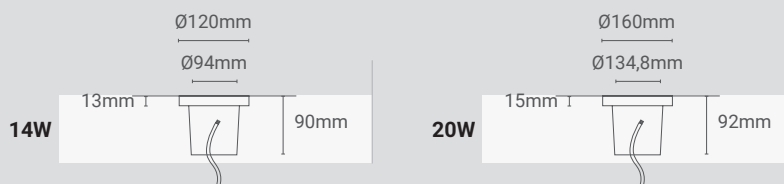
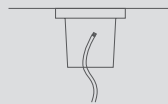

INGROUND WALK-ON IP67

TYPE

LED fixtures with SMD technology for inground installation; walk-on fixtures.

CHARACTERISTICS

Complete with finishing ring and completely sealed transparent glass.

MATERIALS

Metal body, brushed steel ring, shockproof IK10 glass screen; plastic sleeve.

NB

Do not use with drivers for halogen lamps; 12V AC/DC power supply not included.

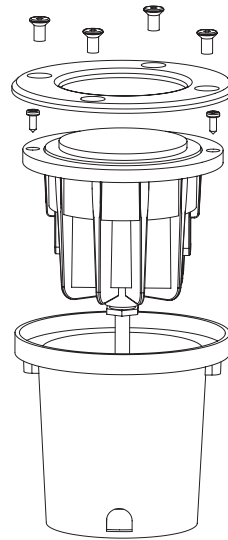

PLUS		12V AC/DC	Ra>80		35000h L70	IP67	IK10	-20° +35°C		G3	Risk Group 1		
art.	W	lm	cd	K	PF		Ø	H				8011905	
DU401430	14	1000	1100	3000	0,70	60°	120	90	94	680	843885	32	
DU402030	20	1600	4000	3000	0,70	36°	160	92	135	1110	843892	16	

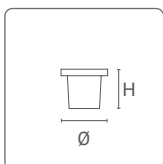

PLAFO T2

TYPE

LED lamps with SMD technology in a fixture for ceiling or surface installations. Version with proximity sensor.

CHARACTERISTICS

Excellent light diffusion across the entire surface. Non-replaceable internal power supply.

MATERIALS

Metal body; satin effect plastic diffusor.

APPLICATIONS

Typically used in stairwells, apartment and residential building entrances, waiting rooms and surgeries, etc.

NB

Do not use with dimmers. Connection to the mains with terminal block.

Version with proximity sensor: ideal where increased visibility and safety is required obtaining the certainty of energy saving.

The sensor is housed inside a cover and is therefore invisible.



BASIC	220-240V 50/60Hz	Ra>80		20000h L70 B30	IP40	-25° +35°C		G3	Risk Group 0	
--------------	---------------------	-------	--	-------------------	------	---------------	--	-----------	-----------------	--

art.	W	lm	cd	K	PF		Ø	L		8011905	
LC001W	20	1650	370	3000	0,7	120°	280	90	350	862688	10
LC001	20	1700	400	4000	0,7	120°	280	90	350	861162	10
LC002W	30	2550	570	3000	0,97	120°	400	120	750	862695	5
LC002	30	2600	600	4000	0,97	120°	400	120	750	861179	5

art.	W	lm	cd	K	PF		Ø	L		8011905	
LC001-MW *	20	1600	400	4000	0,70	120°	270	90	290	927349	10

* Fixture fitted with a proximity sensor.

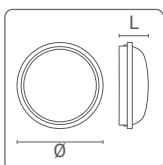

LC001-MW

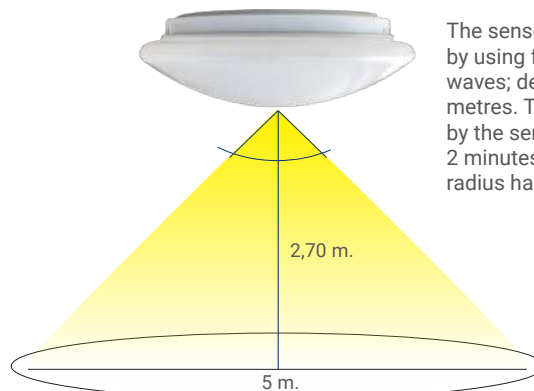

The sensor detects movement by using frequency modulation waves; detection distance 5-8 metres. The fixture is turned on by the sensor and stays on for 2 minutes once the detection radius has been cleared.



PLAFO T2

4000K

BULKHEAD T&O IP65



IP65	IK10
------	------

BASIC	25000h L70 B30
--------------	-------------------

PRO	50000h L70 B20
------------	-------------------

ACCESSORIES



APPLICATIONS

Stairwell lighting, terraces, corridors, common areas, gardens, bathrooms etc.



BULKHEAD T&O IP65

TYPE

IP65 ceiling/wall light with new generation LED sources using SMD technology.

CHARACTERISTICS

Typically used for diffused lighting for both indoor and outdoor or wet environments (IP65). Substitutes ceiling fixtures with fluorescent lamps to give immediate lighting without flickering and increased duration.

MATERIALS

Shockproof plastic IK10 body and screen. Driver on board not accessible.

MOUNTING

The bracket attaches to the wall or the ceiling and the fixture is screwed onto the bracket.

NB

No Dimming. The 50.000 hour version is suitable for public tenders.

220-240V 50/60Hz	Ra>80		IP65	IK10	-20° +35°C		Risk Group 0
---------------------	-------	--	------	------	---------------	--	--------------

	BASIC	25000h L70 B30	G3
--	-------	-------------------	----

art.	W	lm	cd	K	PF		L	Ø			
BH20	20	2000	560	4000	0,9	120°	73	220	432	843632	10

	BASIC	25000h L70 B30	G3
--	-------	-------------------	----

art.	W	lm	cd	K	PF		L	L1	H			
BH015	15	1500	410	4000	0,9	120°	63	114	214	278	843656	10

	PRO	50000h L70 B20	G5/ h24
--	-----	-------------------	------------

art.	W	lm	cd	K	PF		L	Ø			
BH20LL	20	2000	560	4000	0,9	120°	73	220	432	848750	10

	PRO	50000h L70 B20	G5/ h24
--	-----	-------------------	------------



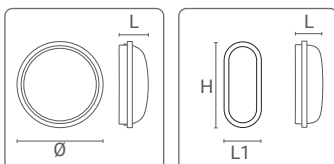

art.	W	lm	cd	K	PF		L	L1	H			
BH015LL	15	1500	410	4000	0,9	120°	63	114	214	278	849443	10



ACCESSORIES T&O







Black or white anti-glare for round bulkhead

art		L	Ø		 8011905	
KTBH20HMB		55	227	62	861032	1
KTBH20HMW		55	227	62	861247	1



Black or white grid accessory for round bulkhead

art		L	Ø		 8011905	
KTBH20GRB		54	227	65	861216	1
KTBH20GRW		54	227	65	861209	1

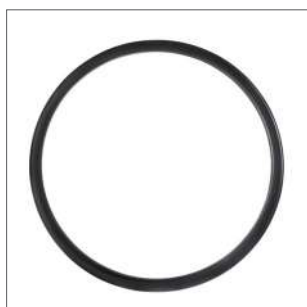



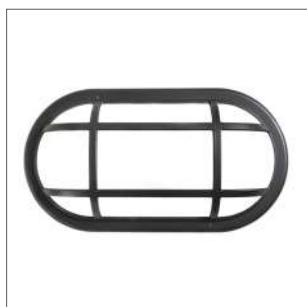

Black ring accessory for round bulkhead

art		L	Ø		 8011905	
KTBH20ARB		24	227	50	861056	1







Black or white grid accessory for oval bulkhead

art		L	H	L1		 8011905	
KTBH15GRB		120	220	46	50	861230	1
KTBH15GRW		120	220	46	50	861223	1



Black ring accessory for oval bulkhead

art		L	H	L1		 8011905	
KTBH15ARB		120	220	24	40	861070	1

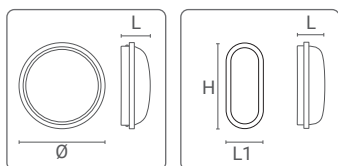

SEGNASENTIERO IP65

TYPE

Wall mounted. Surface pathway markers

CHARACTERISTICS

Three light shielding versions for different lighting effects: full light, downwards and up&down.

MATERIAL

Heat-resistant plastic body; opal polycarbonate screen.

INSTALLATION

Surface with the bracket supplied.

APPLICATIONS

Pathway marker.

LUCE 1



LUCE 50 2



UP&DOWN 3



BASIC	220-240V 50/60Hz	Ra>80		25000h L70 B30	IP65	-25° +35°C		G2	Risk Group 0
-------	---------------------	-------	--	-------------------	------	---------------	--	----	-----------------

art.	Photo	W	lm	K	PF		L	L1	L2	8011905	
SW001W	1	4	370	3000	0,51	120°	140	140	51	927424	50
SW001N	1	4	370	4000	0,51	120°	140	140	51	927455	50
SW002W	2	4	180	3000	0,51	120°	140	140	53	927431	50
SW002N	2	4	180	4000	0,51	120°	140	140	53	927462	50
SW003W	3	4	100	3000	0,51	120°	140	140	53	927448	50
SW003N	3	4	100	4000	0,51	120°	140	140	53	927479	50

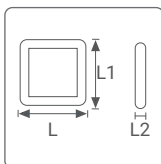

ZOE STEP-MARKER IP54

TYPE

Die-cast aluminium recessed step-marker.

CHARACTERISTICS

Extremely compact, indirect lighting, staggered reflective compartment to maximise flux and optics protected from insects.

MATERIAL

Powder coated die-cast aluminium in three different colours.

INSTALLATION

Recessed using the springs supplied.

APPLICATIONS

Step-marker. Ideal for use on stairs to improve safety.

WHITE 1



GREY 3



BLACK 2



BASIC	220-240V 50/60Hz	Ra>80		15000h L70 B20	IP54	-25° +35°C		G2	Risk Group 0
-------	---------------------	-------	--	-------------------	------	---------------	--	----	-----------------

art.	Photo	W	lm	K	PF	L	H	L2	8011905	
ZW01W-W	1	3	90	3000	0,7	84	84	30	941178	10
ZW01N-W	1	3	90	4000	0,7	84	84	30	941185	10
ZW01W-B	2	3	90	3000	0,7	84	84	30	941192	10
ZW01N-B	2	3	90	4000	0,7	84	84	30	941208	10
ZW01W-G	3	3	90	3000	0,7	84	84	30	941215	10
ZW01N-G	3	3	90	4000	0,7	84	84	30	941222	10

Installed with counter casing

art.	8011905
KT000B	8011905972271

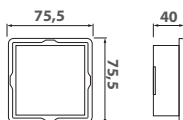

The back box is automatically shipped with each ZOE tracker.

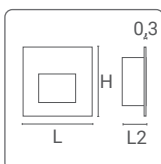



ZOE STEP-MARKER IP54

4000K

DRIVER AND CONTROLLERS

DURASTRIP DRIVERS CONSTANT VOLTAGE

CHARACTERISTICS

SELV equivalent; protection device in case of short circuit or overload in the secondary circuit.

IP20



**FLICKER
FREE** III



art.	W	Volt IN	Volt OUT	PF	L1	L2	H	8011905	
New SLD-50-24	50	100-240Vac	24Vdc	0,9	280	30	17	976439	1
New SLD-80-24	80	100-240Vac	24Vdc	0,9	320	30	17	976422	1



**FLICKER
FREE** III



art.	W	Volt IN	Volt OUT	PF	L1	L2	H	8011905	
ZK73100-SL *	100	200-240Vac	24Vdc	0,9	320	30	18,5	843915	1

* To be discontinued

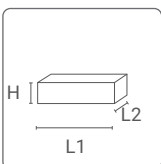

DURASTRIP DRIVERS CONSTANT VOLTAGE

IP67



**FLICKER
FREE**



art.	W (Volt IN)	W (Volt IN)	Volt OUT	PF	L	L2	H	8011905	
ELG-75-24DA-3Y	75 (220-240Vac)	60 (100-120Vac)	24Vdc	0,9	180	63	35,5	975807	1
ELG-100-24DA-3Y	96 (220-240Vac)	70 (100-120Vac)	24Vdc	0,9	199	63	35,5	975753	1
ELG-150-24DA-3Y	150 (220-240Vac)	105 (100-120Vac)	24Vdc	0,9	219	63	35,5	975760	1
ELG-200-24DA-3Y	200 (220-240Vac)	150 (100-120Vac)	24Vdc	0,9	244	71	37,5	975821	1
ELG-240-24DA-3Y	240 (220-240Vac)	180 (100-120Vac)	24Vdc	0,9	244	71	37,5	975814	1

Dimming curve expressed as a function of the load, i.e. inversely proportional to the percentage value of the power supply load. If the product is used at full load, the dimming curve is linear from 10 to 100%, if it is used at half load, the dimming possibility is halved, i.e. a dimming on the control side of 50% will produce a real load dimming of 25%. It is important to distribute the power evenly over the power supplies in the same area of the installation to achieve consistent dimming levels. It is important to distribute the power evenly over the power supplies in the same area of the installation to achieve consistent dimming levels.



**FLICKER
FREE**



art.	W	Volt IN	Volt OUT	PF	L	L2	H	8011905	
New XLG-100-24-A	100	100-240Vac	24Vdc	0,9	140	63	32	976958	1
New XLG-150-24-A	150	100-240Vac	24Vdc	0,9	180	63	35,5	976941	1
New XLG-200-24-A	200	100-240Vac	24Vdc	0,9	199	63	35,5	976934	1
New ELG-240-24A-3Y	240	100-240Vac	24Vdc	0,9	244	71	38	981303	1
New HLG-320H-24	320	100-240Vac	24Vdc	0,9	252	90	44	981297	1
New HLG-600H-24A	600	100-240Vac	24Vdc	0,9	280	144	49	976491	1
HLG-320H-48A⁽¹⁾	320	100-240Vac	48Vdc	0,95	252	90	44	931575	1

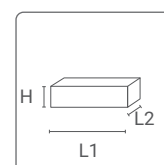

MULTI-CURRENT CONSTANT CURRENT DIMMABLE POWER SUPPLIES

IP20

CHARACTERISTICS

Can be used with fittings with replaceable remote driver.
220÷240V 50/60Hz



FLICKER FREE



art.	W Max	Volt IN	OUTPUT current	PF	L1	L2	H		8015466	
New A01486 *	42	220/240Vac/dc	450÷1100mA	0,95	103	68,5	30,5	170	162287	1

* DALI 2 - DALI Push

Suitable for use in a centralised power supply for emergency lighting.

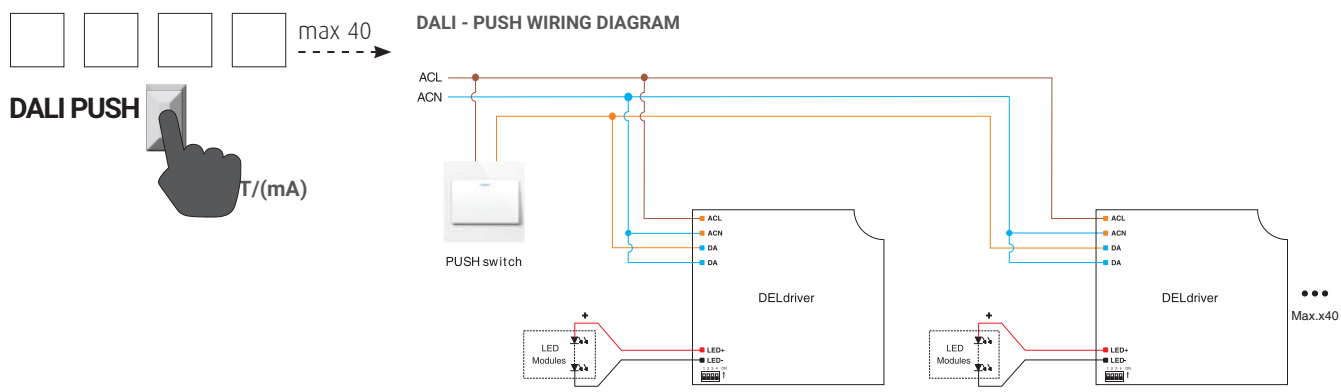

FLICKER FREE



art.	W Max	Volt IN	OUTPUT current	PF	L1	L2	H		8011905	
DELT40D-M	40	220/240Vac	300÷1050mA	0,95	147	44	30	137	863210	1

* DALI 2 - DALI Push

Suitable for use in a centralised power supply for emergency lighting.



FLICKER FREE



art.	W Max	Volt IN	OUTPUT current	PF	L1	L2	H		8011905	
DELT65D-M **	60	220/240Vac	800÷2000mA	0,95	125	80	30	245	935474	1

** DALI 2 - 1-10V - DALI Push

MULTI-CURRENT CONSTANT CURRENT DIMMABLE POWER SUPPLIES

DALI / DALI PUSH

IP20



FLICKER FREE



Volt IN

art.	W Max	Volt IN	OUTPUT current	PF	L1	L2	H		8011905	
New ZK600-14000S	50	220/240Vac	600÷1400mA	0,95	110	75	26	113	933265	1

* DALI 2 - 1-10V - DALI Push

Suitable for use in a centralised power supply for emergency lighting.

Preset power supply for Slimflux CCT panels, 680mA OUT.

DALI WIRING DIAGRAM

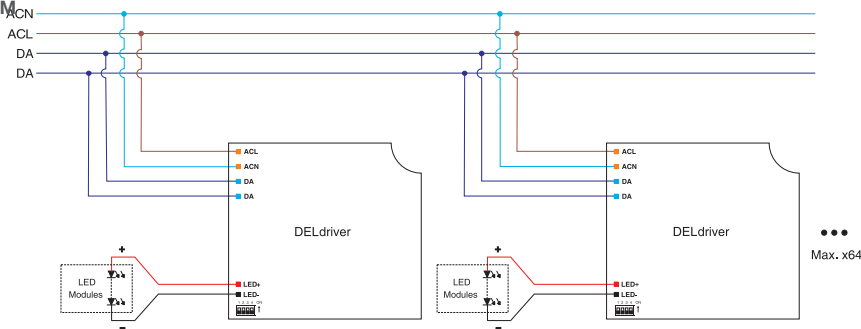

Max.x40



FLICKER FREE

1-10V

art.	W Max	Volt IN	OUTPUT current	PF	L1	L2	H		8011905	
New DELT40D-10V	40	220/240Vac	550÷1050mA	0,95	141	46	28	129	993061	1

1-10V

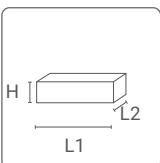

MULTI-CURRENT CONSTANT CURRENT DIMMABLE POWER SUPPLIES

IP20

CHARACTERISTICS

Can be used with fittings with replaceable remote driver.
220÷240V 50/60Hz



FLICKER FREE III



art.	W Max	Volt IN	OUTPUT current	PF	L1	L2	H		8015466	
New A01484	40	220/240Vac/dc	800÷1000mA	0,95	142	50	30	95	162263	1

Suitable for use in a centralised power supply for emergency lighting.



FLICKER FREE III



art.	W Max	Volt IN	OUTPUT current	PF	L1	L2	H		8015466	
New A01485	40	220/240Vac/dc	700÷900mA	0,95	142	50	30	95	162270	1

Suitable for use in a centralised power supply for emergency lighting.

CONSTANT CURRENT POWER SUPPLIES



FLICKER FREE III



art.	W Max	Volt IN	OUTPUT current	PF	L1	L2	H		8011905	
New ZKLP700EL	31.5	220/240Vac/dc	750mA	0,95	119	42,5	28	95	990350	1
New ZKLP1400-EL	60	220/240Vac/dc	1400mA	0,95	156	50	38	195	990565	1

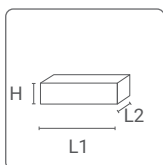

TRANSFORMERS CONSTANT VOLTAGE OUTPUT ELECTRONIC LED POWER SUPPLY

IP20

NOTE

It is advisable not to charge the driver more than 55% of its power in order to consider the in-rush current of LED lamps.



art.	W	Volt IN	Volt OUT	PF	L1	L2	H	8011905	
New SLD-50-12	50	110-305Vac	12Vdc	0,9	280	30	17	976880	1
New SLD-80-12	80	110-305Vac	12Vdc	0,9	320	30	17	976873	1

TRANSFORMER FOR 12V HALOGEN LAMPS



art.	W	Volt IN	Volt OUT	L1	L2	H	8011905		
DELT12150P *	50-150	220-240Vac	11,5Vac	180	46	36	230	826468	25

* To be discontinued

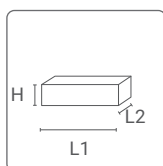



CONTROL INTERFACE TO BE USED WITH DURASTRIP

Dimming and control systems can be used to improve the ambient aspect: they help creating special, different, soft and always lively atmospheres. Moreover, they have an important function of energy saving: by varying the emission and/or activating/deactivating the system or appliances, they allow optimising the presence of solar lighting.



PRO
IP20
III
G5/h24

DALI CONTROLLER FOR DURASTRIP white light

art.	Max current (A)	Volt OUT	Volt IN	Connection	IP	L1	L2	H	 8011905 
ZKCDA	10/CH	12-24V _{DC}	12-24V _{DC}	Screw	20	167	51	23	833367 1

2-channel controller.

1-10V CONTROLLER for DURASTRIP white light

art.	Max current (A)	Volt OUT	Volt IN	Connection	IP	L1	L2	H	 8011905 
ZKC1-10	10	12-24V _{DC}	12-24V _{DC}	Screw	20	168	51	23	833374 1

It can be used with all White light Durastrips.



DALI INTERFACE

The DALI (Digital Addressable Lighting Interface) is a digital protocol interfacing with the power supplies. It is widely used in the lighting field as it provides visible benefits compared to the 1-10V analog control technology (it is essentially a flexible, digital control that allows addressing the single appliances).

The DALI protocol allows defining appliance units and managing the lighting sceneries, to create the right lighting of an ambient according to its use. Different lighting sceneries can be configured and enabled using a simple key, without involving the system wiring.

The DALI protocol is more simple and economic compared to the integrated management systems of a building (building management).

A DALI network can control up to 64 appliances/lamps.



1-10V DIMMING INTERFACE

The 1-10V luminous intensity control system runs with analog technology: 1 corresponds to 0% and 10 to 100% of the lamp emission.

The intensity can be adjusted by using the linear curve or logarithmic curve and it is the simplest system to install.

The connection is carried out by 2 polarity wires placed between the power supply and controller. It can be used with active or passive control systems.

How to use DURASTRIP with our controllers? Here the indications of maximum power.		DURASTRIP 24VDC
	ZKCDA	240W/CH
	ZKC1-10	240W

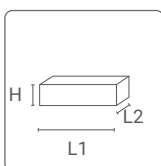

DURASTRIP WIRING DIAGRAMS

DURASTRIP CONTROLLERS: 1-10V scheme

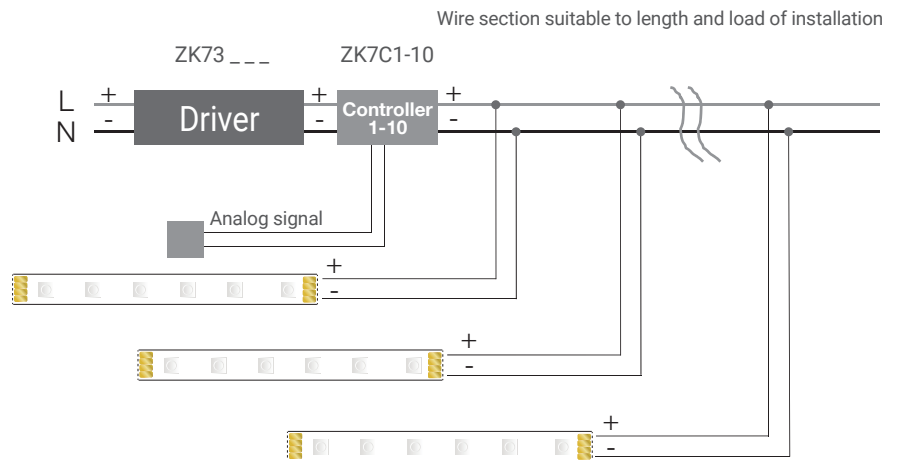

DURASTRIP CONTROLLERS: DALI scheme (Push)

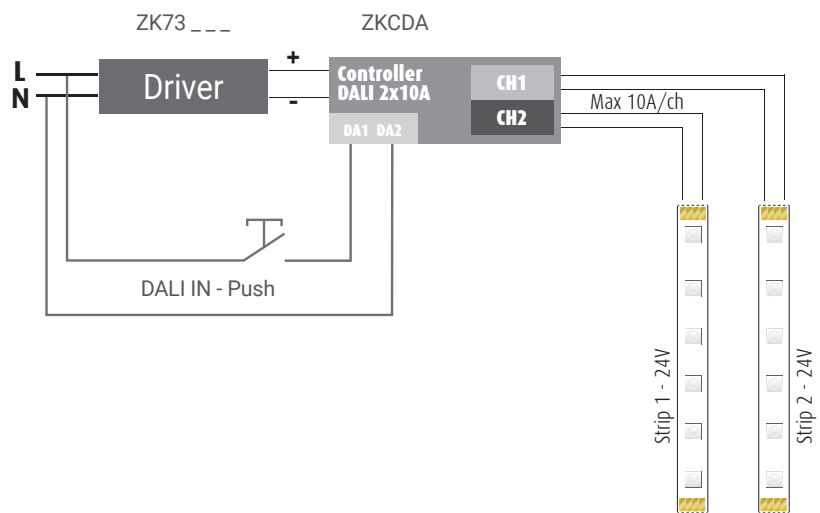

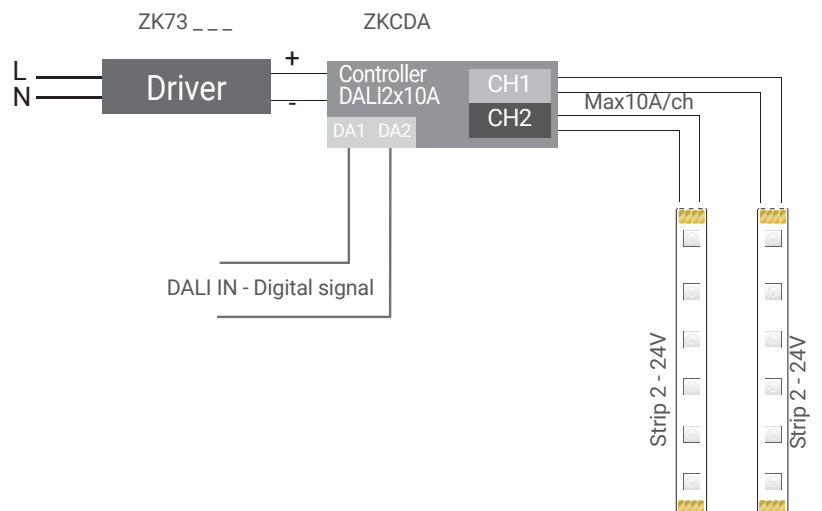

DURASTRIP CONTROLLERS: DALI Scheme



CONTROL INTERFACE TO BE USED WITH DURASTRIP



DMX CONTROLLER FOR DURASTRIP RGB (or white on 3 channels)

art.	Max current (A)	Volt OUT	Volt IN	Connection	IP	L	L2	H	 8011905 
ZKCDMX-R *	5/CH	12-24V _{DC}	12-24V _{DC}	RJ45/Screw	20	178	42	33	838795 1

It can be used with all DuraStrip RGB, and white.

* Version with RJ45 connector, which can be used in a traditional way or with remote control included in the package.



DMX 4 CHANNELS CONTROLLER FOR DURASTRIP RGB+WHITE (or 4 channels)

art.	Max current (A)	Volt OUT	Volt IN	Connection	IP	L	L2	H	 8011905 
ZKCDMXW	5/CH	12-24V _{DC}	12-24V _{DC}	Screw	20	168	51	22	838942 1

Can be used with DuraStrip RGB+white.

Connection diagrams are available at www.duralamp.it (in the product datasheet).

PWM signal repeater for 4 channels white light strips

art.	Max current (A)	Volt OUT	Volt IN	Connection	IP	L	L2	H	 8011905 
ZKREP-4CH	5/CH	24V @ 480W	12-36V _{DC}	Screw	20	178	46	22	862701 1
ZKREP-4CH-IP	5/CH	24V @ 480W	12-36V _{DC}	Screw	67	181	74	38	862718 1



DMX INTERFACE

DMX512, which abbreviation is DMX (Digital MultipleX), is a communication protocol mainly used to control lighting (even LED type), from computers or control units. It is normally used to control colored lighted or white lighted appliances (RGB) with variable temperature.

Thanks to the high transmission speed of the data, the DMX allows making dynamic and even complex sceneries.

A DMX network consists in 512 channels; the number of appliances that can be controlled cannot be defined beforehand, as it depends on how many DMX channels each appliance uses. E.g., if every appliance of the DMX network uses 3 DMX channels, the network can contain 170 appliances.

ZKCDMX-R code version: Equipped with RJ45 connector for DMX signal, complete with looping system and remote sensor with plug (20 cm cable). It can be used in a traditional way or with remote control included in the packaging (signal distance 10 mt in free air).

How to use DURASTRIP with our controllers? Here the indications of maximum power.		DURASTRIP 24VDC
	ZKCDMX	144W/CH
	ZKCDMX-R / ZKCDMXW	120W/CH

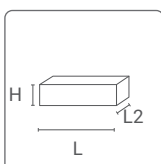

DURASTRIP
CONTROLLERS:
DMX scheme
linear system

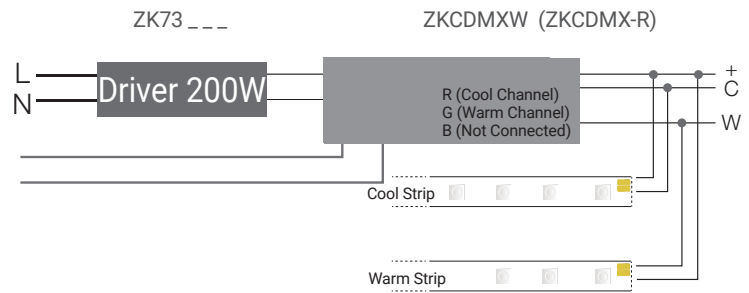

Example of of strip secondary unit

DURASTRIP
CONTROLLERS:
DMX Scheme

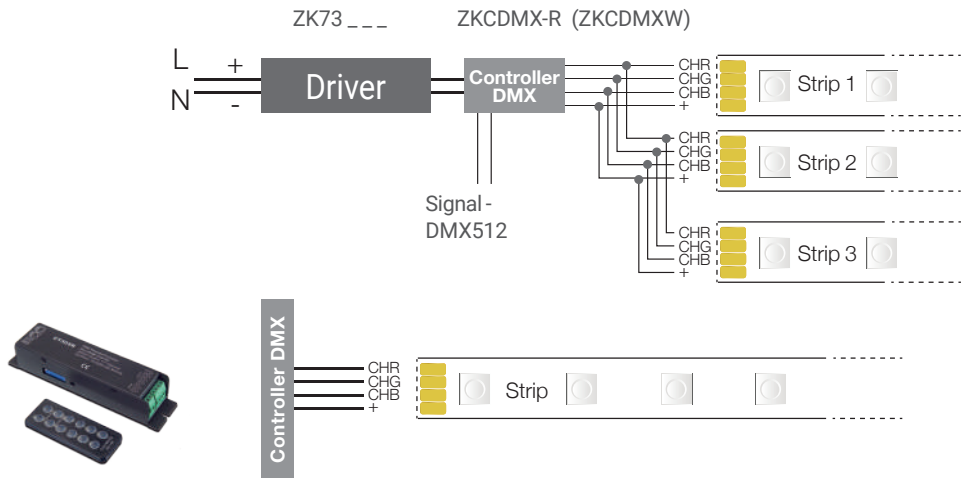

DURASTRIP
CONTROLLERS:
DMX IR Scheme

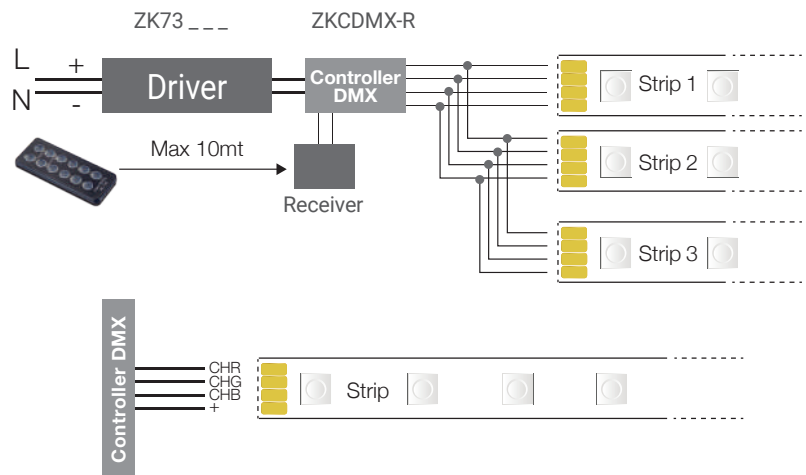

DURASTRIP RGBW
CONTROLLER RGB+W
(Cod. ZKCDMXW)

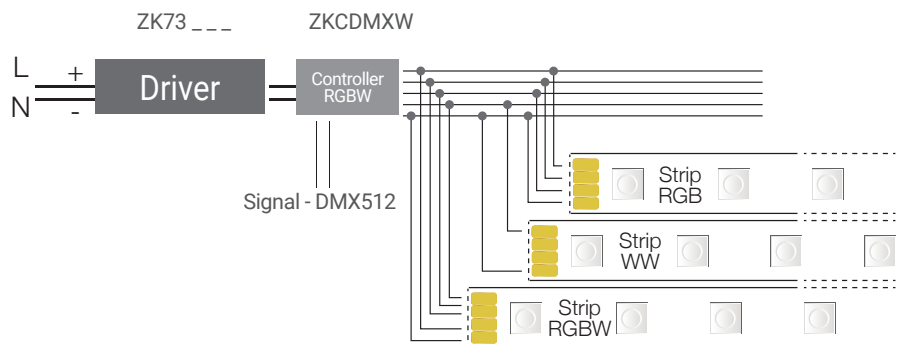

WALL TOUCH DIMMER - DMX

TYPE

Dimmers for DURASTRIP white, for DURASTRIP CTC, DURASTRIP RGB and RGB+white.

CHARACTERISTIC

external interface in tempered glass with high touch sensibility, immediate response to touch and control precision. 4 zones can be controlled separately or synchronised. Conforms with protocol DMX512(1990). Can be used with ZKCDMX, ZKCDMX-R, ZKCDMXW. Dimmer's driver included in the box (220-240Vac / 5Vdc). Easy installation and intuitive use.



PLUG AND PLAY!

DMX WALL TOUCH DIMMER FOR WHITE LIGHT DURASTRIP

art.	Input Voltage	Number of DMX channels	Number of areas	Number of scenes	L1	L2	L3	8011905	
ZKTPC-DIM	5Vdc	4	4	4	86	86	10	839635	1

Each channel can have 256 levels of light variation and 4 favourite scenes can be saved.

"Memory" function: the last color temperature chosen is recalled when the light is switched back on again; 3 scenes can be saved.

DMX WALL DIMMER FOR CTC EFFECT

art.	Input Voltage	Number of DMX channels	Number of areas	Number of scenes	L1	L2	L3	8011905	
ZKTPC-CTC	5Vdc	8	4	3	86	86	10	839642	1

Each channel can have 256 levels of light variation and 3 favourite scenes can be saved.

"Memory" function: the last color temperature chosen is recalled when the light is switched back on again; 3 scenes can be saved.

DMX WALL TOUCH DIMMER FOR RGB - RGBW DURASTRIP

art.	Input Voltage	Number of DMX channels	Number of areas	Number of scenes	L1	L2	L3	8011905	
ZKTPC-RGBW	5Vdc	16	4	4	146	106	10	839659	1

"Memory" function: the last color level chosen is recalled when the light is switched back on; 4 favourite scenes can be saved. Simultaneous or synchronous control of the RGB colors and white. 36 setting modes.

DMX DIAGRAMM

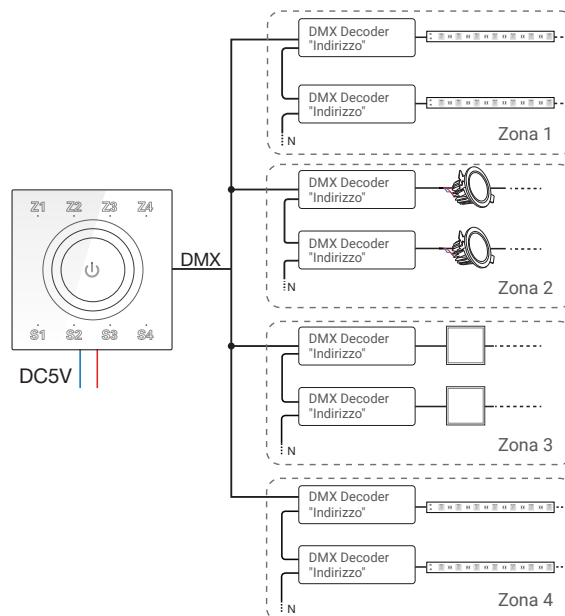

DURASTRIP WIRING DIAGRAMS

DURASTRIP DIMMER TOUCH



Max power indications for the use of DURASTRIP with the controllers.

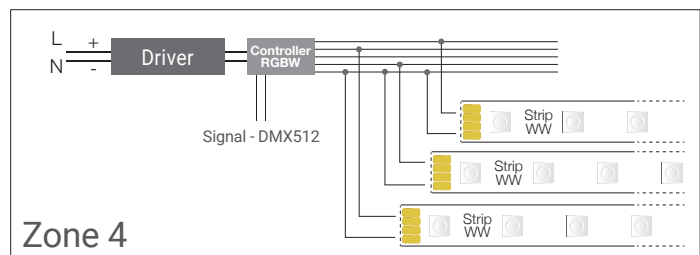
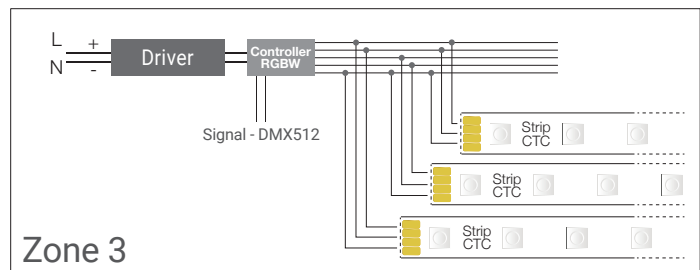
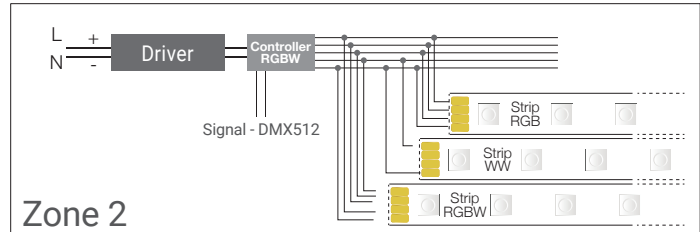
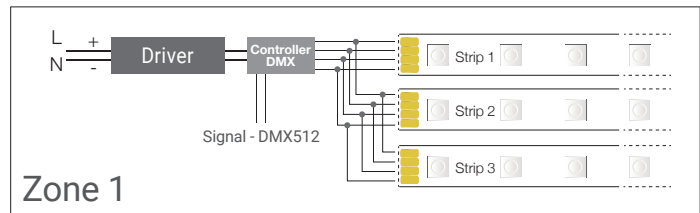

STANDBY LIGHTING FOR FITTINGS

CHARACTERISTICS

Emergency electronic unit for standby lighting suitable for current controlled power LED.

Can be used for maintained or emergency operation.

Can be used with max 2A-90V.

Battery life: 3 hours (Battery pack dimensions: 135x45x23mm); battery inserted in a protective case in accordance with regulations.

Residual flux in emergency 7%.

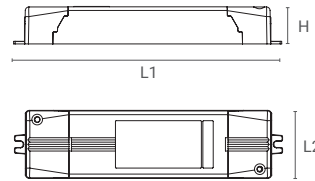

Emergency working voltage (VL)	Emergency output current (I)
6-70V	10-62mA

LED EMERGENCY KIT FOR STANDBY LIGHTING* for fittings

art.	Volt IN	L1	L2	H		8011905	
KTEMR03	220-240V	166,5	46	25	185	933012	1

* As indicated by the UNI EN 1838.

Reserve lighting means lighting that allows you to continue normal activity without substantial change. Fixtures indicated as compatible with the kit have passed the required tests for the reserve lighting category in compliance with EN 60598-2-22

ACCESSORIES FOR FITTINGS

	Safety wire and junction box art					8011905	
	LP-SSK	Junction box for connection to the mains, prepared for connection in cascade, equipped with safety suspension kit with steel cable for installations in seismic zones.	1200	854768	1		
	Junction box art					8011905	
	FASTCON-30	Junction box for connection to the power supply network, prepared for connection in cascade (cable length 27cm)	270	854775	1		

INFO AND TECHNICAL DATA

KEY

PRODUCT CATEGORY KEY

BASIC	Ideal products for markets of consumers who desire a LED product and are seeking the most convenient solution in terms of its cost.
PLUS	Articles with outstanding performance and the best quality-price ratio, the best solution for the majority of applications.
PRO	Products for specific applications and top-level features, especially appreciable by industry professionals.

LED WARRANTY SPECIFICATIONS KEY

















Warranties on all LED fixtures and LED lamps:

G2 anni GARANZIA	Up to 2 years (4000h/year)*	*4000h = 11h a day x 365 days. Without limitations on the duration of use for the first year, provided the observance of the installation conditions.
G3 anni GARANZIA	Up to 3 years (4000h/year)*	*4000h = 11h a day x 365 days. Without limitations on the duration of use for the first year, provided the observance of the installation conditions.
G4/h24 anni GARANZIA	Full Guarantee 4 years (24h/24h)	h24, provides Total Warranty! The winning element for great projects.
G5/h24 anni GARANZIA	Full Guarantee 5 years (24h/24h)	h24, Total Warranty up to 5 years use!

The specific guarantee that each item enjoys is clearly indicated in the catalog and is subject to compliance to the limitations of use. For details, refer to www.duralamp.it or contact the sales force.

KEY

TABLE PAGES KEY

W	Rated watts for lamps or fixtures
V	Lamp or fixture voltage
lm	Lumen: unit of measurement of the flux emitted by a lamp or fixture. In the case of DURALAMP'S fixtures it indicates the real emission of the fixture in stable conditions. This data is the same used in the photometrics for lighting calculations.
K	K= Kelvin colour temperature indicated in Kelvin.
COLOUR NM	Colour in nanometres, unit of spatial measurement of wavelengths of visible/invisible radiation.
	Lamp cap
PF	Power Factor
	Beam opening
Ø/L1/L2/L3/H	Diameter and other dimensions expressed in mm except where otherwise indicated.
	Weight of single item article in grams (except where otherwise indicated)
	Minimum packaging: complying with packaging quantities when ordering speeds orders and ensures greater safety of goods.
	Minimum order quantity
	Class I Fixture- Fixture with protective earthing
	Class II Fixture – Fixture with double insulation, no earthing required
	Class III Fixture – Low voltage fixture, no earthing required
	Can be used in the open air, in open fixtures and without protective glass
	Only use in fixtures fitted with protective glass
	Elimination of UV rays.
	Do not cover with insulating material
	Can be used with a dimmer. A list of compatible dimmers is found in individual product files on the web site.
	Not to be used with a dimmer.
	Adjustable
UGRXX	UGRxx: Indicates the degree of glare: the lower the number, the lower the glare
Ra>XX	Colour Rendering Index
XX000h	Operating life in hours indicated as L70 or L50, always measured at 25° room temperature AT. The life-span is modified substantially with a rise in temperature.
	Updated tech. data

KEY

LX0	Operating life of a LED fixture or lamp maintaining the indicated flux: L70= 70% flux; L50= 50% flux.
IK08	IK Code, International Protection Marking, classifies and rates the degree of protection for light fixtures against external mechanical impact. IK01 0,15 Joule IK02 0,20 Joule IK03 0,35 Joule IK04 0,5 Joule IK05 0,7 Joule IK06 1,00 Joule IK07 2,00 Joule IK08 5,00 Joule IK09 10,00 Joule IK10 20,00 Joule
IPXX	IP Code, International Protection Marking, classifies and rates the degree of protection for light fixtures against the intrusion of solid particles (first number) and water (second number). IP20 protected against solid objects up to Ø 12 mm. IP23 protected against solid objects up to Ø 12 mm and sprays of water. IP40 protected against solid objects over Ø 1 mm. IP43 protected against solid objects over Ø 1 mm and sprays of water. IP44 protected against solid objects over Ø 1 mm and splashed water. IP54 protected against dust and splashed water. IP55 protected against dust and low pressure jets of water. IP65 Totally protected against dust and low pressure jets of water. IP66 Totally protected against dust and strong jets of water. IP67 Totally protected against dust and temporary immersion. IP68 Totally protected against dust and immersion in water (with an indication of the permitted depth in metres).
IPVI IPVO	IP rating of the internal housing side (VI) and Optic side IP rating (VO)

All measurements are expressed in mm except where expressly indicated.

NB

Available on order: the message "Available on order" often appears in the catalogue. We've added it to offer our customers the broadest choice option. Careful though: if an article is available "on order", it means that it is not readily available in stock and only minimum quantities are available for purchase. We therefore recommend that you contact sales for further details.



CERTIFIED QUALITY

All Duralamp products are CE marked, ie they comply with all applicable European Directives. The UL mark is issued after certification of the product by third parties such as UL, an independent, non-governmental and non-profit organisation whose mission is to ensure that products conform to standards set by ANSI, the American National Standards Institute. UL certification is therefore a Quality and Safety mark and is required for products to be used in the United States and countries that make reference to the same standards.

The EAC mark is the Euroasian Conformity mark required for exporting products to the Customs Union of Russia, Belarus, Armenia, Kazakhstan, Kyrgyzstan. It is comparable to the CE mark and refers to the declaration of compliancy to the technical standards required by the Eurasian Customs Union.

CERTIFIED COMPANY



Duralamp operates under ISO 9001, an international reference standard for quality management of all company processes.

TECHNICAL ANALYSIS

lm

FLUX AND EFFICIENCY

Luminous Flux and Efficiency represent the key information for the evaluation of the performance of a product. What do they represent exactly? Luminous flux represents the emission of the LED source, that is the total amount of light produced by the light source. Efficiency represents the ration between the emission and the power absorbed by the source, that is the total amount of emitted light divided per the energy consumed by the LED source. Nowadays there is not a sole way of publishing these data, each company on the market makes its own choice. This means that catalogues of different companies publish different kinds of information, ranging from the data declared by LED producers to values referable to the LED source in peculiar conditions, but also to values that take into account the "loss" due to reflectors, lenses, drivers and so on. In general, the most reliable data is the value measured on the fixture in its effective usage conditions. In order to let our customers have a clearer idea of the declared data, Duralamp specifies for each LED fixture both its effective flux/efficiency values and the values directly referable to the source, as declared by the producer. The purpose of this methodic choice is to simplify the understanding of the data, and, consequently, to provide our customer the immediate possibility of comparison among Duralamp lighting fixtures and those by other brands. The rapid technical progress of LED sources results in continuous changes in terms of luminous flux and, consequently, efficacy. The information provided by the catalogue should therefore be referred to the date of publication - for regularly updated information please visit the site web.

L70

LED LIFESPAN

LED lamps, unlike traditional lamps do not suddenly stop working but gradually decrease their initial flow unless there are defects or electric shocks. A LED lamp is considered to be no longer functioning it reaches 70% of their initial flow (L70). Life tests are performed following standard IES LM-80. The life span of LED lamps is strongly influenced by the lamps operating temperature once they are installed in fixtures. Duralamp fixtures are designed to have a very low LED operating temperature to ensure the lamps have a very long lifespan.

L80 B10

According to the IEC / PAS 62717 standard, the useful life of a LED can be defined with an additional parameter, for example 50'000h L80B10, meaning the period of time (50'000h) in which 10% (B10) of the LED products of the same type has gradually fallen below 80% of the initial nominal flux.

TC

TEMPERATURE AND PERFORMANCE

The working temperature of a LED source has a significant effect on its useful life, maintenance of luminous flux and efficiency. Correct temperature management, i.e. thermal management of the power in use is a crucial factor in ensuring the performance and reliability of products.

The main characteristic to determine reliability of a product and consistency of performance is measuring the junction temperature (Tj), that can be measured indirectly as luminous flux and the useful life are linked to this parameter. Tj values between 60°C and 90°C allow you to have products with high reliability, performance and estimated lifespans that adhere to market demands.

Careful attention must be paid when reading the declared data given that LED manufacturers provide data on the flux at a temperature of Tj 25°C, a condition that is not physically possible for normal use where the LED source is turned on and tested in a fraction of a second and does not produce any heat. Duralamp products are measured and characterised for thermal stability to provide real data on everyday use for the catalogue and users. Well-designed fixtures that ensure proper dissipation also ensure constant flow, colour and spectrum parameters as well as reliability and durability in the declared lifespan.



COLOUR CONSISTENCY

LED lamps have extensive production tolerances in relation to chromaticity. For years Duralamp has only used lamps with colour consistency that is measured using the MacAdam Ellipse system. This allows for absolute repeatability of the colour characteristics compared to the binning based system. LED lamps used by Duralamp are at least 3-steps of MacAdam (3SDCM).

Ra

COLOUR RENDERING INDEX CRI or Ra

The colour rendering index CRI indicates the ability of a light source to reveal colours faithfully. Lighting a coloured object with two sources with different CRI will reveal different colours depending on the source used. It is important not to confuse the CRI with data relating to the colour temperature of a source (expressed in K); two sources with the same colour temperature can have different colour rendering indexes. The CRI strongly influences the efficiency of a LED source and many times lighting designers have to

choose between the quality and quantity of light. The LED sources that are fitted in products in the Duralamp collection normally have a colour rendering index that reaches CRI 85. In some case there are also sources with a high colour rendering index (CRI>95).

TM30

New TM30 Standard - a more precise colour definition

It is evident that a single index is not sufficient to completely characterize the colour rendering of a source. The TM-30 is the method by which we group together well-known evaluation systems, organized in a systematic way, with the introduction of two other different indexes, the Fidelity Index Rf (which indicates the fidelity of colour rendering) and the Gamut Index Rg (used to evaluate the increase or decrease in saturation), in turn accompanied by a form of graphic representation. Furthermore the method evaluates the illuminant on 99 samples (CES) that reflect the colours of the leaves, flowers, skin tones, paintings, etc. so as to extend our ability to establish its specific rendering.

UGR

UGR

UGR (Unified Glare Rating) is a unified factor in the international field developed by the CIE (International Commission on Illumination) to evaluate direct discomfort glare due to the use of lighting products. In the European Standard relating to indoor workplaces UNI EN 12464-1, the UGR varies from a minimum value of 10 (no glare) to a maximum value of 30 (considerable glare). The lower the value the lower the glare. The UGR value needs to be calculated because it takes into account the size and characteristics of the environment, the background luminance (ceiling, wall, etc), the luminance of light fixtures and the position of the latter in relation to the observation point.

UGR classification applications

- <13 imperceptible
- ≤16 perceptible technical drawings
- ≤19 perceptible reading, writing, schools, offices, working on a pc
- ≤22 perceptible industry and crafts
- ≤25 uncomfortable raw industrial jobs
- ≤28 uncomfortable railway tracks, warehouses
- >28 intolerable

Flicker



Fixtures with the "SAFE FLICKER" logo have parameters of $P_{st}^{LM}=1$ and $SVM \leq 1$, in compliance with regulations IEC TR 61547-1 and IEC TR 63158, to ensure a more comfortable and safe light.

- **P_{st}^{LM} (Short-Term flicker)**

Quantifies visible Flicker that is harmful to human health caused by the modulation of light in the frequency range between 0.3Hz and 80Hz.

The recommended threshold is $P_{st}^{LM} = 1$.

Note – This value was determined based on a representative test group of people and identifies the average perception threshold of visible flicker.

- **SVM (Stroboscopic Visibility Measure)**

Quantifies stroboscopic effects that can occur in situations relating to objects in movement in the presence of modulation of light in the frequency range between 80Hz and 20KHz.

SVM=1 represents the visibility threshold in a test group of people that quantifies the stroboscopic effect in defined laboratory conditions.

Fixtures that do not bear the "SAFE FLICKER" logo on the other hand show the flicker value declared by the driver manufacturer which is not determined according to IEC criteria.

Constant renewal of drivers will bring about the introduction of new models in line with IEC requirements. For more details and/or specific needs please contact our technical department.

Technical details

Flicker is defined as “the rapid variation of the intensity of a light source over time”; in particular that relating to the frequency range between 0-80Hz.

When fluctuations on the other hand belong to the interval between 80Hz-2KHz this are called “Stroboscopic effects” in which light fluctuation produces an incorrect perception of the movement of objects lit by the same source by a static observer.

This phenomenon became increasingly important following the introduction of LED light sources for general lighting given the combination of the following aspects:

- LED sources are characterised by a high speed response to fluctuations in the power supply which translate into variations of the light emitted
- Unwanted residual fluctuations of the driving current of LED sources generated by the electronic power supplies used
- Modulation of the driving current of LED sources for example PWM (Pulse Width Modulation), necessary to adjust the emission level
- Any instability in the operation of dimmers connected externally to the LED source power supplies

This fluctuation in light intensity, according to the frequency, intensity, viewing angle, level of light in the environment, age of the observer and their sensitivity level, can be perceptible on a conscious and/or unconscious level and generate a series of side effects depending on the sensitivity level such as: headaches, visual fatigue, distraction etc.

In order to mitigate the risks on health in lighting contexts using LED sources, recommendations have been developed for the American market (see: IEEE Std 1789™-2015), and the European market with Technical Reports IEC TR 61547-1 and IEC TR 63158.

The graphic below summarises the limits provided for in the two different “regulations”, based on different evaluation mechanisms to establish when a fixture is “SAFE” for observers.

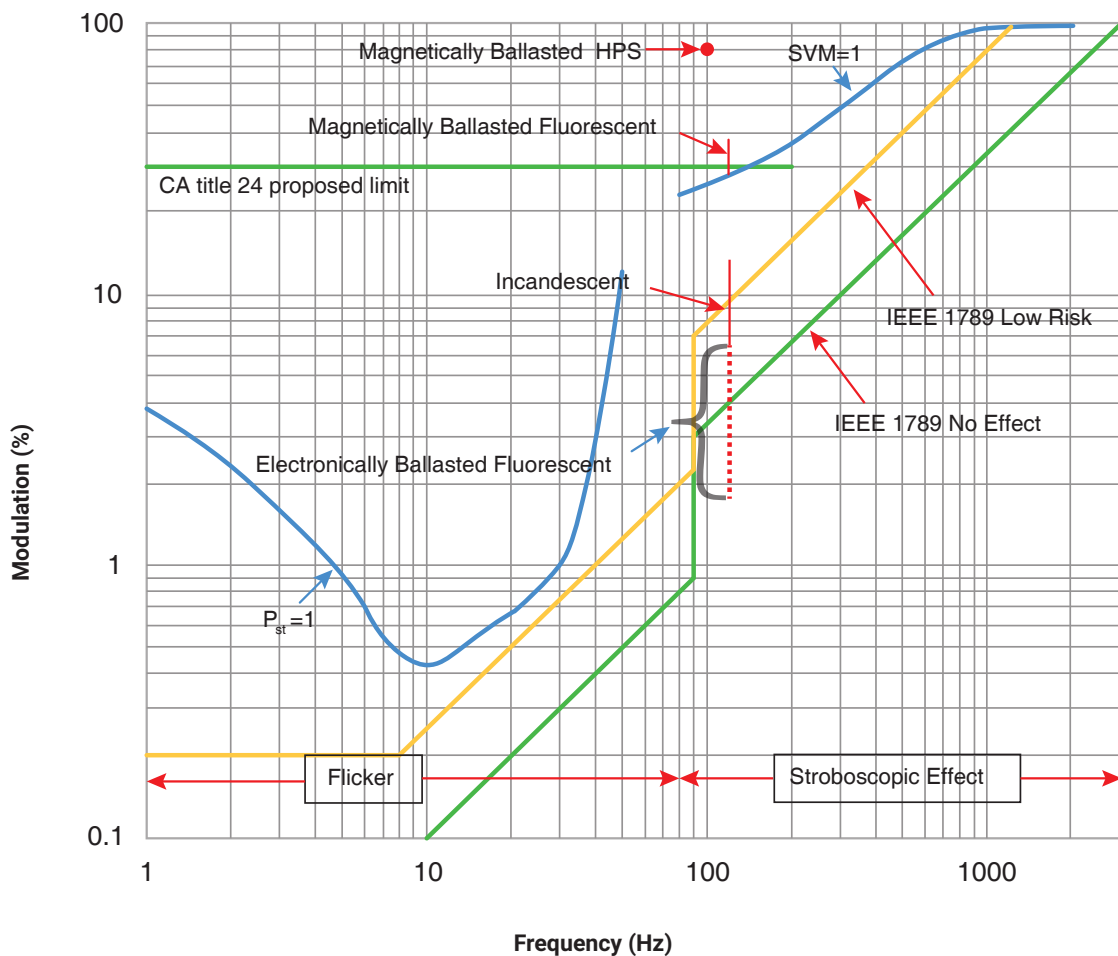

PHOTOMETRICS KEY

Photometric measurements were taken at the Duralamp Photometric Laboratory. These measurements are performed at a room temperature equal to 25 ± 1 °C as required by UNI EN 13032-1 - Light and lighting - Measurement and presentation of photometric data of lamps and luminaires - Part 1.

The photometric values quoted are dependent on the optical system to which they relate, and from the light source used. In order to improve its production, the Company reserves the right to change these optical systems and consequently relative photometric data without notice.

For ease of use, the photometric curve present within this catalogue is shown and explained below.

On the web site www.duralamp.it the special section "INFO TECH /Eulumdat" provides all the photometric data in ldt. format that is also given on every product datasheet.

The photometric curves shown in this catalogue are compiled according to the "C-γ" international reference system, where the C0-C180 plane is perpendicular to the fixtures and the C90-C270 plane is parallel to the fixtures, as depicted in the figure. For symmetrical and rotationally symmetric fixtures therefore, a single curve is used.

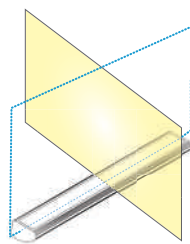

REFERENCE "C-γ"

— TRANSVERSE PLANE
Plane C0° - C180°
Beam angles α

⋯ LONGITUDINAL PLANE
Plane C90° - C270°
Beam angles β

POLAR DYAGRAM

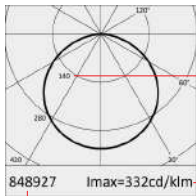

LUMINOUS INTENSITY
PHOTOMETRIC CURVE
IMAX

PHOTOMETRIC CODE: these are the last 6 digits of the item's barcode

4000K Ra90		KELVIN - IRC/Ra
Fixture Power	12W	FIXTURE POWER
Source Flux	1180lm	LED FLUX
Fixture Flux	1180lm	FIXTURE FLUX
Efficacy	98lm/W	EFFICACY
Imax	391cd	IMAX

H(m)	D(m)	Emax(lx)	
	118°		BEAM ANGLE
1	3.31	391	DISTANCE FROM THE PLAN (m)
2	6.61	98	
3	9.92	43	Ø LUMINOUS CONE (m)
4	13.23	24	
5	16.53	16	MAX ILLUMINATION (lx)

All Duralamp luminaires have integrated LED sources that cannot be separated: therefore the source flux and the luminaire flux show the same value.

INDEX

12PR1530RGB	155	B60-3SW	62	D82540SL2	41	DS08L160Q	39
12PR1860RGB	155	B603W	64	DBAQ100-B	109	DS08L160T	39
28530LL	103	B604B	62	DBAQ100-W	109	DS10L130Q	39
28540LL	103	B604RB	62	DBAT100-B	108	DS10L130T	39
A01484	171	B604RW	62	DBAT100-W	108	DS10L140Q	39
A01485	171	B604W	62	DBIN100-0	111	DS10L140T	39
A01486	169	B60MB	65	DBSP115-B	105	DS10L160Q	39
B6010B	63	B60MW	65	DBSP115-W	105	DS10L160T	39
B6010W	63	B60RC10B	65	DBSP130-B	105	DT30L130	35
B60111	63	B60RC10W	65	DBSP130-W	105	DT30L140	35
B60115B	63	B60RC11B	65	DBSP215-B	105	DT30L160	35
B60115W	63	B60RC11W	65	DBSP215-W	105	DT40L130	35
B6011B	64	B60RC13B	65	DBSP230-B	105	DT40L140	35
B6011W	64	B60RC13W	65	DBSP230-W	105	DT40L160	35
B60123	65	B60RC17B	65	DBTR160-B	103	DT40L1CCT	37
B6012B	64	B60RC17W	65	DBTR160-W	103	DT80L130	35
B6012W	64	B60RC1B	65	DELTA12150P	172	DT80L140	35
B6013B	64	B60RC1W	65	DELTA40D-10V	170	DT80L160	35
B6013W	64	B60SP	63	DELTA40D-M	169	DT80L1CCT	37
B6014B	64	B60T	65	DELTA65D-M	169	DT80L1CCTHP	37
B6014W	64	BH20	161	DH25L130	49	DT80L1HP30	35
B6015B	64	BH20LL	161	DH25L140	49	DT80L1HP40	35
B6015W	64	BH015	161	DH30L130EX	47	DT80L1HP60	35
B6016B	64	BH015LL	161	DH30L140EX	47	DU401430	157
B6016W	64	BT103C	125	DH30L2EXCCT	45	DU402030	157
B6017B	64	BT103N	125	DH40L130	49	ELG-100-24DA-3Y	168
B6017W	64	BT103W	125	DH40L130EX	47	ELG-150-24DA-3Y	168
B6018B	64	BT104C	125	DH40L140	49	ELG-200-24DA-3Y	168
B6018W	64	BT104N	125	DH40L140EX	47	ELG-240-24A-3Y	168
B601B	63	BT104W	125	DH40L2EXCCT	45	ELG-240-24DA-3Y	168
B60-1RB	62	BT105C	125	DH60L130	49	ELG-75-24DA-3Y	168
B60-1RW	62	BT105N	125	DH60L140	49	FASTCON-30	91 - 97 - 179
B60-1SB	62	BT105W	125	DH80L130	49	HB2-100	135
B60-1SW	62	CLE2624	112	DH80L130EX	47	HB2-100DALI	135
B601W	63	CLE2624S	112	DH80L140	49	HB2-150	135
B60220	56 - 61 - 65 - 104	CLE2715	113	DH80L140EX	47	HB2-150DALI	135
B60221	56 - 61 - 65 - 104	CLE2715-S	113	DH80L2EXCCT	45	HB2-200	135
B602B	63	CLE2715-SWH	113	DS04L130Q	39	HB2-200DALI	135
B60-2RB	62	CLE2715-WH	113	DS04L130T	39	HB3-100	129
B60-2RW	62	CLE2724	112	DS04L140Q	39	HB3-150	129
B60-2SB	62	D306TNW	51	DS04L140T	39	HB3-200	129
B60-2SW	62	D306TNW-D	51	DS04L160Q	39	HBL12001N	131
B602W	63	D306TWW	51	DS04L160T	39	HBL12001W	131
B603B	64	D306TWW-D	51	DS08L130Q	39	HBL12002N	131
B60-3RB	62	D41540QSL2	41	DS08L130T	39	HBL6001N	131
B60-3RW	62	D41540SL2	41	DS08L140Q	39	HBL6001W	131
B60-3SB	62	D82540QSL2	41	DS08L140T	39	HBL6002N	131

HLG-320H-24	168	KTTB50ACO1-W	56	LP6060B1UGR-930	79	LRT560WW	123
HLG-320H-48A	168	KTTB50ACO-B	56	LP6060B1UGR-940	85	LRT590CW	123
HLG-600H-24A	168	KTTB50ACO-W	56	LP6060B1UGR-9CCT	86	LRT590NW	123
JZ03BNW	151	KTTB50AGL1-B	56	LP6060B2-840	79	LRT590WW	123
JZ03BWW	151	KTTB50AGL1-W	56	LP6060B2UGR-840	79	MAR11840CCTBL	29
KT000B	164	KTTB50AGL-B	56	LP6060B2UGR-8CCT	86	MAR11840CCTWH	29
KTBH15ARB	162	KTTB50AGL-W	56	LP6060B2UGR-940	79	MAR12740CCTWH	29
KTBH15GRB	162	KTTB60ACO1-B	56	LP6060B3-830	76	MAR13000DIMBL	29
KTBH15GRW	162	KTTB60ACO1-W	56	LP6060B3-840	76	MAR13000DIMCO	29
KTBH20ARB	162	KTTB60ACO-B	56	LP6060B3-860	76	MAR13000DIMWH	29
KTBH20GRB	162	KTTB60ACO-W	56	LP6060NEX	88	MNLO16EP12FLO30E	148
KTBH20GRW	162	KTTB60LENS	56	LP6060NWB5	74	MNLO16EP12FLO40E	148
KTBH20HMB	162	KTTB80ACO1-B	56	LP6060NWB5-UGR	74	MNLO16EP12WGC30E	148
KTBH20HMW	162	KTTB80ACO1-W	56	LP6060NWQ4	91	MNLO16EP12WGC40E	148
KT-BHL-SP	131	KTTB80ACO-B	56	LP6060P1-840	80	MNLO32EP24FLO30E	148
KT-BT1-FS	125	KTTB80ACO-W	56	LP6060P1UGR-840	80	MNLO32EP24FLO40E	148
KTDH25-LENS	49	KTTB80AGL1-B	56	LP6060P2-840	80	MNLO32EP24WGC30E	148
KTDH40-LENS	49	KTTB80AGL1-W	56	LP6060P2-860	80	MNLO32EP24WGC40E	148
KTDH60-LENS	49	KTTB80AGL-B	56	LP6060S1UGR-830	82	MNLO64EP48WGC30E	148
KTDH80-LENS	49	KTTB80AGL-W	56	LP6060S1UGR-840	82	MNLO64EP48WGC40E	148
KTEMR03	179	KTTB80LENS	56	LP6060S1UGR-940	82	ORDEV1	148
KTHB2-100-F	135	KTTSL2	41	LP6060WWQ4	91	PANTH-B10N	141
KTHB2-100-LENS110	135	LC001	158	LP60T830-A	92	PANTH-B20N	141
KTHB2-100-LENS60	135	LC001-MW	158	LP60T830DE-A	92	PANTH-B30N	141
KTHB2-100-PCR	135	LC001W	158	LP60T840-A	92	PANTH-B30NS	143
KTHB2-100-R	135	LC002	158	LP60T840DE-A	92	PANTH-B50N	141
KTHB2-200-LENS60	135	LC002W	158	LP6262S1UGR-830	82	PANTH-B50NS	143
KTHB2-200-LENS90	135	LND0760NW	152	LP6262S1UGR-840	82	PANTH-SL1002	133
KTHB3-100-G	129	LP30120B1-840	85	LP6262UGR-840	82	PANTH-SL1502	133
KTHB3-100-PCR	129	LP30120B1UGR-9CCT	86	LPLAFO120	96	PANTH-SL2002	133
KTHB3-100-R60	129	LP30120B2-840	79	LPLAFO1203	96	PANTH-ST100C	139
KTHB3-200-G	129	LP30120B2-860	79	LPLAFO301204	96	PANTH-ST100N	139
KTHB3-200-PCR	129	LP30120B2UGR-940	79	LPLAFO60	96	PANTH-ST100W	139
KTHB3-200-R60	129	LP30120NWB5-UGR	74	LPLAFO601204	96	PANTH-ST10C	139
KTLPQ4-MS	90	LP30120P1-840	80	LPLAFO603	96	PANTH-ST10N	139
KTLPQ4-SM	90	LP30120S1UGR-940	82	LPLAFO604	96	PANTH-ST10W	139
KTLPQ4-SP	90 - 91	LP30120T830DE-A	94	LPLAFO60P	97	PANTH-ST150C	139
KTLP-SPU	97	LP30120T840DE-A	94	LP-SSK	97 - 179	PANTH-ST150N	139
KTLPW1-MS	97	LP60120B1-840	85	LRT5120CW	123	PANTH-ST150W	139
KTLRT	123	LP60120B1UGR-9CCT	86	LRT5120NW	123	PANTH-ST200C	139
KTLRT-CORD	123	LP60120P1-840	80	LRT5120WW	123	PANTH-ST200N	139
KTMNLBKT15	148	LP6060B1-830	85	LRT5150CW	123	PANTH-ST20C	139
KTMNLBKT30	148	LP6060B1-840	85	LRT5150NW	123	PANTH-ST20N	139
KTMNLBKT45	148	LP6060B1-840HP	85	LRT5150WW	123	PANTH-ST20W	139
KTMNLBKTVERT	148	LP6060B1-860	85	LRT530CW	123	PANTH-ST250C	139
KTQ8SL2	41	LP6060B1NEX	88	LRT530NW	123	PANTH-ST250N	139
KTQSL2	41	LP6060B1UGR-840	85	LRT530WW	123	PANTH-ST250W	139
KTT8SL2	41	LP6060B1UGR-840HP	85	LRT560CW	123	PANTH-ST30C	139
KTTB50ACO1-B	56	LP6060B1UGR-8CCT	86	LRT560NW	123	PANTH-ST30N	139

PANTH-ST30W	139	RTF08L160T	43	TDL-ACO	61	ZKRTG	118
PANTH-ST350C	139	S2T060L1	127	TDL-AGL	61	ZKTPC-CTC	177
PANTH-ST350N	139	S2T120L1	127	TDL-BDF	61	ZKTPC-DIM	177
PANTH-ST50C	139	S2T150L1	127	TDL-LENS24	61	ZKTPC-RGBW	177
PANTH-ST50N	139	SLD-50-12	172	TDL-LENS60	61	ZW01N-B	164
PANTH-ST50W	139	SLD-50-24	167	TDM-ACO	61	ZW01N-G	164
PANTH-STWH100C	137	SLD-80-12	172	TDM-AGL	61	ZW01N-W	164
PANTH-STWH100N	137	SLD-80-24	167	TDM-BDF	61	ZW01W-B	164
PANTH-STWH10C	137	SP01-W	104	TDM-LENS24	61	ZW01W-G	164
PANTH-STWH10N	137	SW001N	163	TDM-LENS60	61	ZW01W-W	164
PANTH-STWH150C	137	SW001W	163	TN-E27B	107		
PANTH-STWH150N	137	SW002N	163	TN-E27CR	107		
PANTH-STWH200C	137	SW002W	163	TN-E27CU	107		
PANTH-STWH200N	137	SW003N	163	TN-E27N	107		
PANTH-STWH20C	137	SW003W	163	TN-E27OT	107		
PANTH-STWH20N	137	T010	119	VA03L130Q	50		
PANTH-STWH250C	137	T053	119	VA03L130T	50		
PANTH-STWH250N	137	TB50L130-B	55	VA03L140Q	50		
PANTH-STWH30C	137	TB50L130-W	55	VA03L140T	50		
PANTH-STWH30N	137	TB50L140-B	55	XLG-100-24-A	168		
PANTH-STWH350C	137	TB50L140-W	55	XLG-150-24-A	168		
PANTH-STWH350N	137	TB60L130-B	55	XLG-200-24-A	168		
PANTH-STWH50C	137	TB60L130-W	55	ZK001	116		
PANTH-STWH50N	137	TB60L140-B	55	ZK002	116		
PANTH-WH10N	141	TB60L140-W	55	ZK003	116		
PANTH-WH10W	141	TB80L130-B	55	ZK004	116		
PANTH-WH20N	141	TB80L130-W	55	ZK600-14000S	170		
PANTH-WH20W	141	TB80L140-B	55	ZK73100-SL	167		
PANTH-WH30N	141	TB80L140-W	55	ZKC1-10	173		
PANTH-WH30W	141	TB80L230-B	55	ZKCD A	173		
PANTH-WH50N	141	TB80L230-W	55	ZKCDMX-R	175		
PANTH-WH50W	141	TB80L240-B	55	ZKCDMXW	175		
RTF03L130Q	43	TB80L240-W	55	ZKLP1400-EL	171		
RTF03L130T	43	TD10S-3K8L-MSP-B	60	ZKLP700EL	171		
RTF03L140Q	43	TD10S-3K8L-MSP-W	60	ZKR1-ST	115		
RTF03L140T	43	TD10S-4K8L-MSP-B	60	ZKR1-STB	115		
RTF03L160Q	43	TD10S-4K8L-MSP-W	60	ZKR2-ST	114		
RTF03L160T	43	TD15M-3K8L-FL-B	60	ZKR2-STB	114		
RTF04L130Q	43	TD15M-3K8L-FL-W	60	ZKR65QB	117		
RTF04L130T	43	TD15M-4K8L-FL-B	60	ZKR65QG	117		
RTF04L140Q	43	TD15M-4K8L-FL-W	60	ZKR65TB	117		
RTF04L140T	43	TD22M-3K8L-FL-B	60	ZKR65TG	117		
RTF04L160Q	43	TD22M-3K8L-FL-W	60	ZKREP-4CH	175		
RTF04L160T	43	TD22M-4K8L-FL-B	60	ZKREP-4CH-IP	175		
RTF08L130Q	43	TD22M-4K8L-FL-W	60	ZKRQB	118		
RTF08L130T	43	TD38L-3K8L-FL-B	60	ZKRQG	118		
RTF08L140Q	43	TD38L-3K8L-FL-W	60	ZKRR	116		
RTF08L140T	43	TD38L-4K8L-FL-B	60	ZKRTB	118		
RTF08L160Q	43	TD38L-4K8L-FL-W	60	ZKRTB2	119		

GENERAL SALES CONDITIONS

1. Applicability

1.1 These general conditions (hereafter the "Conditions") constitute an integral and essential part of the contract of sale between the Parties. The Conditions shall regulate all legal relationships between Duralamp S.p.A. (hereafter "Duralamp") and the purchaser (hereafter the "Purchaser") where the said relationships are not disciplined by the applicable terms of the Italian Civil Code (C.C.). The nullity of any of the terms of these Conditions shall not prejudice the validity of the remaining Conditions or the Contract.

1.2 Any changes to these Conditions shall be agreed between the Parties in writing, with the exception of the provisions set down in article 1341 of the Italian C.C..

2. Sales

2.1 Sale requests for the products (hereafter the "Products") shall be accepted 'subject to the seller's approval' and shall be considered to be irrevocable in accordance with and as an effect of article 1329 of the C.C. for a period of 1 (one) month from the date of the order requesting execution without prior acknowledgement, pursuant to and as an effect of article 1327 of the C.C. from the date on which the order is received by Duralamp.

2.2 The Products detailed in the individual orders and the relevant accessories shall be supplied to the Purchaser by Duralamp with "Retention of Title" pursuant to and as an effect of articles 1523-1526 of the Italian C.C. In this case, the transfer of ownership of the Products to the Purchaser shall take place exclusively upon the full payment of the price agreed, whilst any risks shall be the responsibility of the Purchaser from the moment of delivery of the Products.

2.3 Whilst confirming the terms stated above, the Parties hereby agree that should the Products and relevant accessories be destroyed for causes not attributable to Duralamp, the Purchaser shall not be released from the obligation to pay for the same, even where the Products have not yet been delivered.

3. Prices

3.1 The prices detailed on the price list shall be applied to Product sales orders. The aforementioned prices shall be unit prices per single item, except where stated otherwise for certain Products. The Parties shall have the right to agree, in writing, any derogations and/or special conditions of sale.

3.2 Moreover, the Parties hereby agree that the following conditions shall be applied:

- (I) Minimum order: € 300 (three hundred) for Italy - € 750 (seven hundred and fifty) for other countries;
- (II) Delivery free to destination in Italy for orders of € 300 (three hundred) for Italy or more;
- (III) Ex-Works deliveries for other countries.

3.3 The prices given above do not include VAT and installation costs.

3.4 The prices provided in this catalogue shall be valid until a new price list is published.

4. Currency

All prices are given in Euros (exclusive of VAT). Invoices shall be drawn up in Euros.

5. Special requests

Products can be supplied to the Purchaser in non-standard colours and with special features. The relevant price, minimum quantities per order, methods and timing of deliveries shall be agreed in each individual case, in relation to the reference order.

6. Transport

6.1 Duralamp shall not be liable for any damage and/or losses which may occur during the transportation of the Products, unless the Products are delivered free at destination.

6.2 Duralamp shall have the right to establish the method of transportation to be used for the Products, unless the Parties have previously established a method of transport in writing.

6.3 Upon delivery, the Purchaser shall undertake to verify the condition of the products and shall make any complaints directly to the carrier and/or conduct any actions necessary in the event of loss, misplacement, removal or damage, or delays in transportation and/or the methods of delivery of the Products.

7. Complaints

7.1 In the event that the Products are found to have any faults and/or defects, the Purchaser shall undertake to notify Duralamp of the same in writing, by means of a registered letter, no later than 8 (eight) days following the discovery of the said faults and/or defects, at the risk of invalidating the obligations of the guarantee provided by Duralamp. In this case, the faulty Products, which should be reported within the terms established, should be returned to Duralamp, once the Purchaser has received specific permission to do so in writing.

7.2 In the event that the Purchaser's complaints are held to be valid, Duralamp, at its complete discretion, may make the necessary repairs and/or replace the Products, excluding the attribution of any further charges, obligations, indemnification or compensation to the same. The Products in question should be returned to the Duralamp S.p.A. plant in Via Pratese 164, 50145, Firenze, Italy. In the event that, following an inspection by Duralamp, the Products returned by the Purchaser are not found to be faulty and/or defective, Duralamp shall return the Products to the Purchaser, charging the same an amount equal to 15% (fifteen percent) of the value of the said Products.

8. Delivery

8.1 The Parties hereby agree that the terms established for the delivery of the Products shall not be considered absolute or essential and that, in any case, each item shall be exclusively in favor of Duralamp, unless otherwise agreed in writing between the Parties.

8.2 In the event of delayed delivery, once 15 (fifteen) days have passed since the agreed date, the Purchaser may send Duralamp written warning to complete the delivery within a further term of no more than 15 (fifteen) days from receipt of the same. In the event that Duralamp has not completed the delivery within this further term the Purchaser may withdraw from the order with regard to the Products that have not yet been delivered. In this case the Purchaser shall only be obliged to pay Duralamp for the Products actually delivered, excluding the payment of any further indemnification and/or compensation to the Purchaser.

8.3 Duralamp shall not be responsible for any other breaches, including the failure to deliver or delayed delivery of the Products, caused by events outside its reasonable control such as, purely by way of an example and not limited to the same: the failure to deliver or delayed delivery of manufacturing materials by Duralamp's suppliers, equipment breakdowns, strikes and other trade union action, electricity blackouts, suspension of or difficulties with transportation.

9. Payment

9.1 The price due shall be paid by the Purchaser according to the conditions and modalities set down in the order and, in any case, by means of payments made exclusively to "DURALAMP S.P.A."

9.2 Duralamp shall only recognize the validity of the payments when the same are made in compliance with the provisions of article 9.1 above. This means that amounts paid using any other method shall not be considered to be a payment in discharge of the Purchaser's obligations. The eventual acceptance by Duralamp of a bank draft or other trade bill shall only occur with the application of the proviso "under usual reserve".

9.3 In the event of delayed payment with respect to the terms agreed, the Parties hereby agree that bank interest shall be due to Duralamp at the current PRIME RATE increased by 3 points. Interest shall be applied as of right, with no obligation for Duralamp to send the Purchaser a formal notice to pay.

9.4 Moreover, in the event of a delay in payment of more than 15 (fifteen) days, Duralamp shall have the right to terminate the order as of right pursuant to article 1456 C.C., sending written notification of the same, barring compensation for any damage.

9.5 In the event that the Parties have agreed upon a method of payment by instalments for the Products, the failure to pay several instalments or just one instalment exceeding one eighth of the overall price of the Products, shall result in the loss of the Purchaser's right to pay in instalments and shall give Duralamp the right to request the remaining balance of the price or, alternatively, at its own discretion, to terminate the contract with immediate return of the Products and the acquisition of the instalments paid, as indemnification, barring the right to compensation for any damage sustained.

10. Guarantee

10.1 The Products provided by Duralamp shall be guaranteed for a period of 12 (twelve) months from the date of delivery against any manufacturing or material defects and/or faults and against any breakdowns not attributable to the Purchaser. Duralamp's only obligation and the Purchaser's right with regard to claims related to the guarantee shall be limited, as decided by Duralamp, to the replacement or repair of the defective or non-compliant product or the reimbursement of the price for the purchase of another product. Duralamp shall be granted a reasonable amount of time to repair or replace the product, or to make the previously authorized reimbursement. Any defective or non-compliant Products shall become the property of Duralamp as soon as they have been replaced or reimbursed.

10.2 The guarantee shall exclude any failures due to circumstances beyond the control of Duralamp (lightning, flooding, etc.), as well as any damage caused by the improper use of the Products and/or relevant accessories. Notwithstanding the above, Duralamp shall not be bound by the guarantee if the contested defects or non-compliances have occurred as a result of submitting the Products to resistance or environmental tests, the incorrect use of the same, or in the event that the use of or conditions of use of the Products is different from that indicated in the instructions and technical information, as a result of negligence, incorrect installation or accident, or if they derive from improper repairs, alterations, modifications, storage or transportation or by incorrect handling.

10.3 The Purchaser shall send the Products returned in accordance with the terms of the guarantee to the place indicated by Duralamp in compliance with the Duralamp policy regarding authorization to return materials in force at the time. In the event that the Products returned are found to be compliant or not faulty, the Purchaser shall pay the cost of returning the same as well as the cost of insuring, inspecting and handling the Products.

10.4 LED products Enjoy specific guarantees: details are published on www.duralamp.it

11. Limitation of Liability

11.1 With the sole exclusion of criminal intent and gross negligence, duralamp shall not be liable for loss of profits or savings, loss of reputation or goodwill, any direct, indirect, consequential or special damage that may derive from or be connected to the contract or sale of products or services by duralamp or by the use of the same of a contractual or extra-contractual nature or deriving from any other source, even where duralamp has been notified of or is aware of the possibility of such damage.

11.2 The limitations and exclusions stated in article 11 shall apply within the limits permitted by law.

12. Applicable law and place of jurisdiction

12.1 These Conditions and all the effects of the same shall be governed by Italian law. The Parties hereby agree that any disputes related to these Conditions shall refer to Italian jurisdiction to the exclusion of all others.

12.2 The exclusive place of jurisdiction shall be the registered offices of Duralamp S.p.A., with the express exclusion of any other competing places of jurisdiction.



DURALAMP SPA Single member company
Registered office Via Pratese, 164 – 50145 Firenze
Tel. 055 894 881 – Fax 055 8953 032 / 055 8952 780
e-mail: duralamp@duralamp.it

Registered with the Florence Company Register -
C.F. and VAT number 03312240488
Registered with R.E.A. of Florence at n. 353287 Share capital € 400,000.00 i.v.
Subject to the management and coordination of 3F FILIPPI S.P.A.



A complete list of the Duralamp distribution
and project network is available at:
www.duralamp.it

PROFESSIONAL LIGHTING 2022

REV 0.0

© Copyright 2022 - Duralamp SpA

All data and pictured provided in this catalogue are for reference only: since they might change during mass production, they have to be considered nominal values with tolerances. Duralamp Spa reserves the right to modify its products in any moment, for technical or commercial reasons.

Photos: Ivan Rossi - Andrea Dughetti - Studio Artale - Studio Ceccanti - Alessandro Maurelli - Luca Visentini

Indoor or outdoor setting photos are used to illustrate the possible applications of the product.

3F Filippi | TARGETTI
GROUP

duralamp.it

June 2022
CAT_AP_2022-EN
rev 0



EN