



**DURA**  
LAMP



**MINILINI**

façade lighting

# MINILINI IP65



36° X 80°  
110°

RA>90

PRO

DIMENSIONS:  
30 / 60 / 120 CM

COLOUR TEMPERATURE:  
3000K - 4000K

LIFETIME:  
50000H L70 B20

WARRANTY:  
5 YEARS/24H \*

1  
2

## CHARACTERISTICS

Even illumination of surfaces from a narrow installation space.

## TYPE

Linear projector for outdoor use working at mains voltage.  
Extruded aluminium with an opal polycarbonate cover and minimal dimensions: only 40 mm wide and three length variants.

# Minilini



3

Accessories include a selection of fixed and angled surface mounting brackets or adjustable brackets for further flexibility.

**DURA**  
LAMP

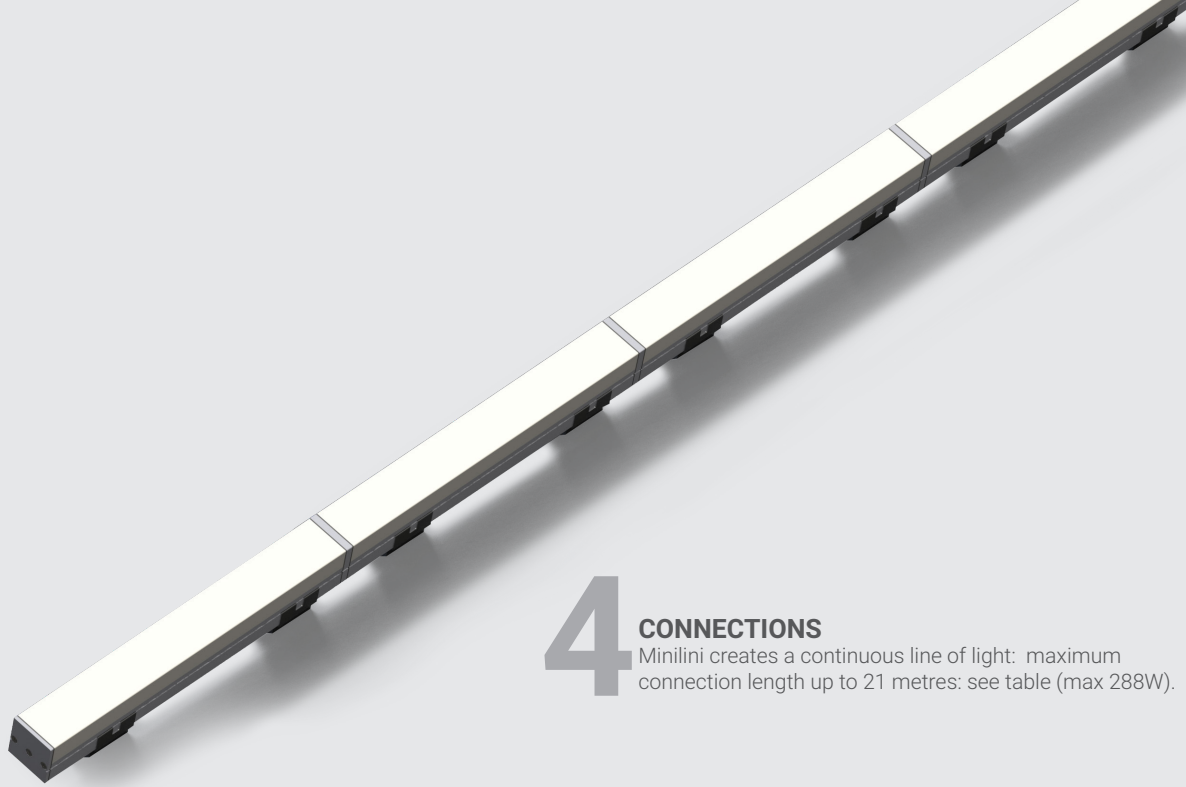

# 4

## CONNECTIONS

Minilini creates a continuous line of light: maximum connection length up to 21 metres: see table (max 288W).

# 5 6

## DIMMABILITY

230V: Dimmable 10-100%; TRIAC Leading edge

## ASSEMBLY

Choice of surface mounting brackets with different fixed angles - 15°, 30°, 45° - or with adjustable brackets of different heights to be ordered with separate codes.

# Minilini



# 7

MINILINI is complete with built-in driver and circuit protection from voltage spikes.  
The IP65 wiring is located underneath the luminaire.

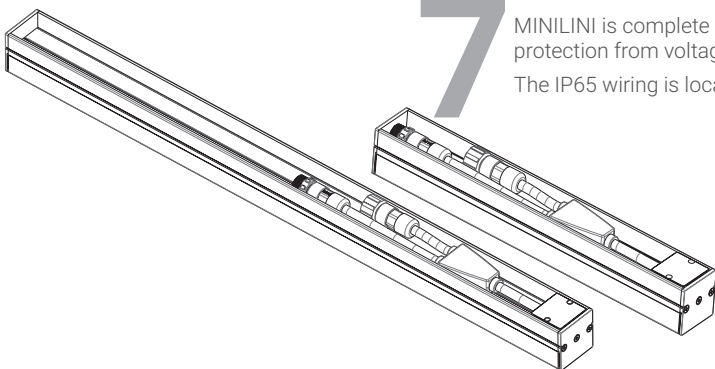

# MINILINI IP65

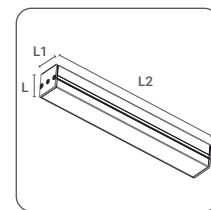

<b>PRO</b>	220-240V 50/60Hz	Ra>90	50000h L70 B20	IP65		-25° +35°C		G5/ h24	Risk Group 1
------------	---------------------	-------	-------------------	------	--	---------------	--	------------	-----------------

art.	W	lm	cd	K	PF		L	H	L1
MNLO16EP12WGC30E	16	850	640	3000	0,95	36°x80°	40	40	295
MNLO16EP12WGC40E	16	880	665	4000	0,95	36°x80°	40	40	295
MNLO16EP12FLO30E	16	695	240	3000	0,95	110°	40	40	295
MNLO16EP12FLO40E	16	720	250	4000	0,95	110°	40	40	295
MNLO32EP24WGC30E	32	1700	1285	3000	0,95	36°x80°	40	40	585
MNLO32EP24WGC40E	32	1760	1330	4000	0,95	36°x80°	40	40	585
MNLO32EP24FLO30E	32	1390	480	3000	0,95	110°	40	40	585
MNLO32EP24FLO40E	32	1440	495	4000	0,95	110°	40	40	585
MNLO64EP48WGC30E	64	3400	2570	3000	0,95	36°x80°	40	40	1200
MNLO64EP48WGC40E	64	3520	2660	4000	0,95	36°x80°	40	40	1200

## MINILINI ACCESSOIRES

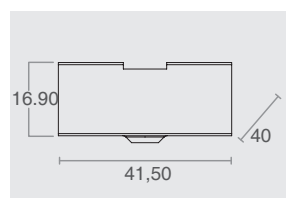

art. KTMNLBKTVERT

304 steel surface mounting bracket for vertical positioning (10 pieces). We recommend using 2 for every module.



1

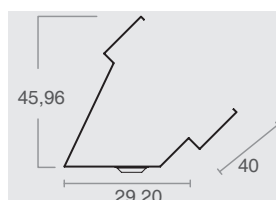

art. KTMNLBKT45

304 steel surface mounting bracket with an angle of 45° (10 pieces).



1

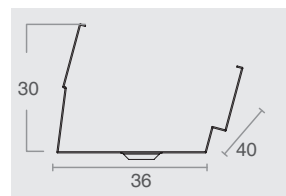

art. KTMNLBKT15

304 steel surface mounting bracket with an angle of 15° (10 pieces).



1

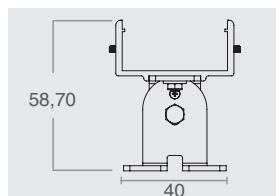

art. ORDEV1

35 mm surface mounting bracket, can swivel 90° in both directions (2 pieces).



1

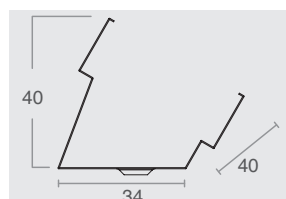

art. KTMNLBKT30

30° steel surface mounting



1

## MINILINI CONFIGURATIONS + CONNECTION TABLE

POWER	WATT SET	Modules size	Max N# of modules	Max length each line	Max W power
4W	1x4W	30,1cm	72	20,4m	288W
8W	1x8W	30,1cm	36	10,2m	288W
8W	2x4W	59,1cm	36	21m	288W
16W	1x16W	30,1cm	18	5,1m	288W
16W	2x8W	59,1cm	18	10,5m	288W
32W	2x16W	59,1cm	9	5,1m	288W
64W	4x16W	114,6cm	4	5,1m	288W