

FLEXALIGHTING

TOP QUALITY ITALIAN LED LIGHTING

smart
news
2022



FLUSH OPTIC
DOWNLIGHTS



RECESSED OPTIC
DOWNLIGHTS



TRIMLESS
DOWNLIGHTS



ADJUSTABLE
DOWNLIGHTS



TRIMLESS
PENDANTS



LINEAR
SYSTEMS



IP RATED
DOWNLIGHTS



UPLIGHTS &
PATHLIGHTS



IP RATED
PROJECTORS

FLEXALIGHTING

Alphabetical index

- ▶ Diddi
- ▶ Dig
- ▶ Flexus
- ▶ Franny
- ▶ Fly
- ▶ Gagarin PT
- ▶ Jos PT
- ▶ Lad T
- ▶ Mauna
- ▶ Minijos T
- ▶ Plexus
- ▶ Sexus
- ▶ Zed
- ▶ Zoe
- ▶ 24VDC Track

FLUSH OPTIC DOWNLIGHTS



FLEXUS 6
6W IP44



FLEXUS 10
10W IP44



FLEXUS 724
7W IP44

RECESSED OPTIC DOWNLIGHTS



FRANNY 6
6W IP44



FRANNY 10
10W IP44



FRANNY 724
7W IP44



ZED
1-2W IP44

TRIMLESS DOWNLIGHTS



DIDDI
1-2W IP44



ZOE 6
6W IP44



ZOE 10
10W IP44



ZOE 724
7W IP44



SEXUS 6
6W IP44



SEXUS 10
10W IP44

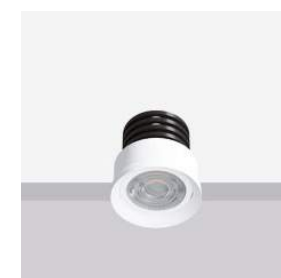

SEXUS 724
7W IP44



SEXUS 6 UGR
6W IP44



SEXUS 10 UGR
10W IP44



SEXUS 724 UGR
7W IP44

ADJUSTABLE DOWNLIGHTS



PLEXUS 6
6W IP44



PLEXUS 10
10W IP44



PLEXUS 724
7W IP44



PLEXUS 6 UGR
6W IP44



PLEXUS 10 UGR
10W IP44



PLEXUS 724 UGR
7W IP44

TRIMLESS PENDANTS



GAGARIN PT2
2W IP20



GAGARIN PT6
6W IP20



GAGARIN PT10
10W IP20



JOS PT2
2W IP20



JOS PT6
6W IP20



JOS PT10
10W IP20

LINEAR SYSTEMS



24VDC TRACK



24VDC TRIMLESS TRACK



MINI JOS T2
2W IP20



MINI JOS T6
6W IP20



MINI JOS T10
10W IP20



LAD T6
6W IP20



LAD T10
10W IP20

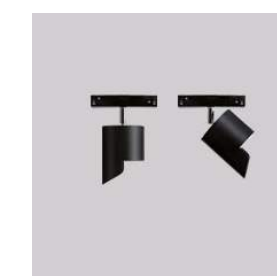

LAD T10 WW
10W IP20

IP RATED DOWNLIGHTS



FLY 6
6W IP67



FLY 10
10W IP67



FLY 724
7W IP67

UPLIGHTS AND PATHLIGHTS



DIG 6
6W IP67



DIG 10
10W IP67



DIG 724
7W IP67

IP RATED PROJECTORS



MAUNA 6
6W IP65



MAUNA 724
7W IP65

FLEXUS 6

design: Rod&Todd

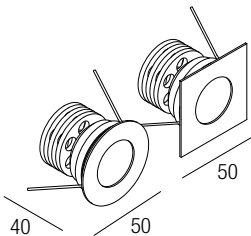

Supply current

Alimentazione
Courant d'alimentation
Stromversorgung
Corriente de alimentación
500 mA (V, 9V)

Power

Potenza
Puissance
Bestuekung
Potencia
6 W

Series wiring

Cablaggio in serie
Câblage en série
Verkabelung in Serie
Cableado en serie



CCT/CRI/Flux

2700K — 540 lm
3000K — 600 lm
4000K — 620 lm

CRI98
2-Step MacAdam

Photometric diagrams

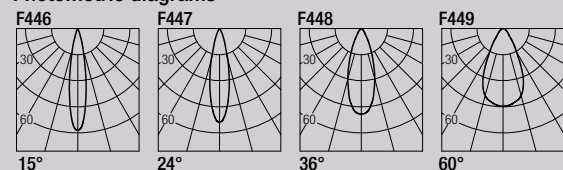

Code Construction

Costruzione del codice - Construction du code produit
Bau der Produkt-Code - Construcción del código de producto

FX6 X X X X

Beam angle
Apertura di fascio
Angle de faisceau
Strahlwinkel
Ángulo del haz

N	S	M	W
15°	24°	36°	60°

Color Temperature

2	3	4
2700K	3000K	4000K

Temperatura colore
Température couleur
Temperaturabhängige Farbe
Temperatura de color

Finishing

1	5
White Bianco Blanc Weiß Blanco	Black Nero Noir Schwarz Negro

Finitura
Finitions
Oberflächenfinish
Acabados

Shape

1	2
Round Tondo Ronde Runde Redondo	Square Quadro Carré Quadrat Cuadrado

Forma
Forme
Form

Drivers

Alimentatori - Alimentateurs
Netzteile - Alimentadores

on/off	dimmmable
500 mA	
AL1074 (1..2) 30mm IP20	AL4010 (1..4) 72mm IP20 PUSH 0/1..10V
AL1077 (1..2) 40mm IP20	AL4151 (1..4) 72mm IP20 DALI
AL1084 (1..3) 55mm IP20 S.P.	AL4153 (1..4) 56mm IP20 PUSH IGBT-TRIAC

Accessories

Accessori - Accessoires
Zubehör - Accesorios

CSFB01

Recessing box
Controcassa
Boîtier d'encastrement
Eingießgehäuse
Caja de empotrar

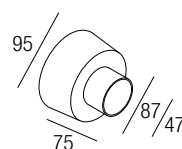

LFX601

Low luminance louver
Filtro antiabbagliamento
Filtre basse luminance
Geringe Leuchtdichte-Filter
Filtro de baja luminancia



SFX601

Milky screen
Schermo opale
Ecran opale
Opal-Bildschirm
Pantalla opal



Note: the filter and the screen must be ordered together with the lighting fixture - **Nota:** il filtro e lo schermo devono essere ordinati congiuntamente all'apparecchio - **Note:** le filtre et l'écran doivent être commandées en même temps que l'appareil
Anmerkung: müssen der Filter und der Bildschirm zusammen mit Leuchtkörper bestellt werden
Nota: el filtro y la pantalla deben pedirse juntos con la luminaria

AL7022

24VDC/500mA constant current converter
Convertitore 24VDC/500mA corrente costante
Convertisseur 24VDC/500mA courant constant
24VDC/500mA konstanter Strom konverter
Convertidor 24VDC/500mA corriente constante



FLEXUS 10

design: Rod&Todd

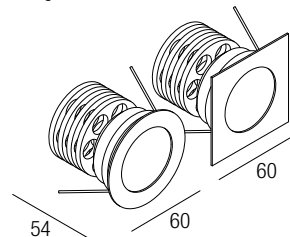

Supply current

Alimentazione
Courant d'alimentation
Stromversorgung
Corriente de alimentación
500 mA (V_I 18V)

Power

Potenza
Puissance
Bestuekung
Potencia
10 W

Series wiring

Cablaggio in serie
Câblage en série
Verkabelung in Serie
Cableado en serie



CCT/CRI/Flux

	CRI85	CRI93
2700K	890 lm	840 lm
3000K	1000 lm	930 lm
4000K	1040 lm	960 lm

CRI85 - CRI93

2-Step MacAdam

Photometric diagrams

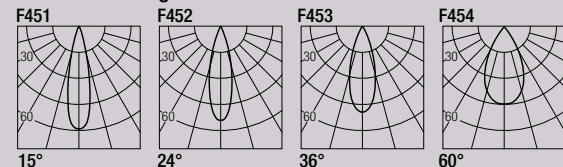

Code Construction

Costruzione del codice - Construction du code produit
Bau der Produkt-Code - Construcción del código de producto

FX1 X X X X X

Beam angle
Apertura di fascio
Angle de faisceau
Strahlwinkel
Ángulo del haz

	N	S	M	W
Beam angle	15°	24°	36°	60°

CRI
85 93

Color Temperature
Temperatura colore
Température couleur
Temperaturabhängige Farbe
Temperatura de color

	2	3	4
Color Temperature	2700K	3000K	4000K

Finishing
Finitura
Finitions
Oberflächenfinish
Acabados

	1	5
White	White	Black
Bianco	Bianco	Nero
Blanc	Blanc	Noir
Weiß	Weiß	Schwarz
Blanco	Blanco	Negro

Shape
Forma
Forme
Form

	1	2
Round	Round	Square
Tondo	Tondo	Quadro
Ronde	Ronde	Carré
Runde	Runde	Quadrat
Redondo	Redondo	Cuadrado

Drivers

Alimentatori - Alimentateurs
Netzteile - Alimentadores

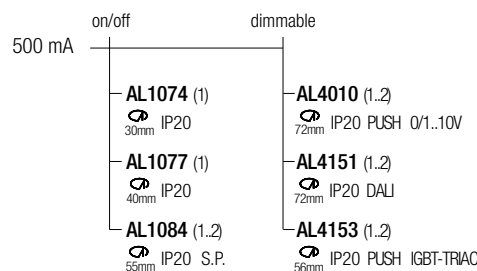

FLEXUS 724

design: Rod&Todd

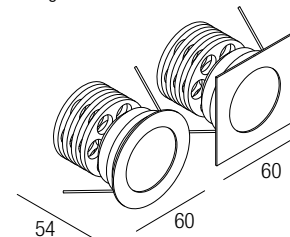

Supply current

Alimentazione
Courant d'alimentation
Stromversorgung
Corriente de alimentación
24 VDC

Power

Potenza
Puissance
Bestuekung
Potencia
7 W

Parallel wiring

Cablaggio in parallelo
Câblage en parallèle
Verkabelung in parallel
Cableado en paralelo



CCT/CRI/Flux

	CRI85	CRI93
2700K	630 lm	590 lm
3000K	700 lm	650 lm
4000K	730 lm	670 lm

CRI85 - CRI93

2-Step MacAdam

Photometric diagrams

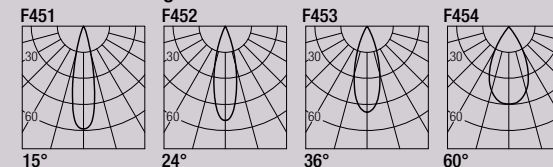

Code Construction

Costruzione del codice - Construction du code produit
Bau der Produkt-Code - Construcción del código de producto

FX24 X X X X X

Beam angle
Apertura di fascio
Angle de faisceau
Strahlwinkel
Ángulo del haz

	N	S	M	W
Beam angle	15°	24°	36°	60°

CRI
85 93

Color Temperature
Temperatura colore
Température couleur
Temperaturabhängige Farbe
Temperatura de color

	2	3	4
Color Temperature	2700K	3000K	4000K

Finishing
Finitura
Finitions
Oberflächenfinish
Acabados

	1	5
White	White	Black
Bianco	Bianco	Nero
Blanc	Blanc	Noir
Weiß	Weiß	Schwarz
Blanco	Blanco	Negro

Shape
Forma
Forme
Form

	1	2
Round	Round	Square
Tondo	Tondo	Quadro
Ronde	Ronde	Carré
Runde	Runde	Quadrat
Redondo	Redondo	Cuadrado

Drivers

Alimentatori - Alimentateurs
Netzteile - Alimentadores

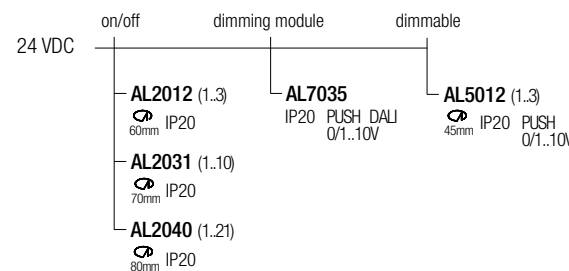

Note: dimming module AL7035 to be used in combination with an on/off 24VDC power supply
Nota: modulo di dimmerazione AL7035 da utilizzare in combinazione con un alimentatore on/off 24VDC
Note: module de variation AL7035 d'intensité à utiliser en combinaison avec une alimentation on/off 24VDC
Anmerkung: Dimmmodul AL7035 zur Verwendung in Kombination mit einem on/off 24VDC-Netzteil
Nota: módulo de regulación AL7035 se utiliza en combinación con una fuente de alimentación on/off 24VDC

Accessories

Accessori - Accessoires
Zubehör - Accesorios

CSFX01

Recessing box
Controcassa
Boîtier d'encastrement
Eingießgehäuse
Caja de empotrar

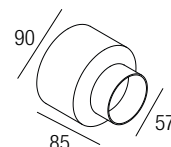

LFX101

Low luminance louver
Filtro antiabbagliamento
Filtre basse luminance
Geringe Leuchtdichte-Filter
Filtro de baja luminancia



SFX101

Milky screen
Schermo opale
Écran opale
Opal-Bildschirm
Pantalla opal



Note: the filter and the screen must be ordered together with the lighting fixture - **Nota:** il filtro e lo schermo devono essere ordinati congiuntamente all'apparecchio - **Note:** le filtre et l'écran doivent être commandées en même temps que l'appareil
Anmerkung: müssen der Filter und der Bildschirm zusammen mit Leuchtkörper bestellt werden
Nota: el filtro y la pantalla deben pedirse juntos con la luminaria

AL7022

24VDC/500mA constant current converter
Convertitore 24VDC/500mA corrente costante
Convertisseur 24VDC/500mA courant constant
24VDC/500mA konstanter Strom konverter
Convertidor 24VDC/500mA corriente constante

Accessories

Accessori - Accessoires
Zubehör - Accesorios

CSFX01

Recessing box
Controcassa
Boîtier d'encastrement
Eingießgehäuse
Caja de empotrar

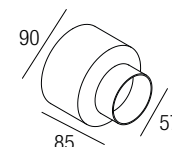

LFX2401

Low luminance louver
Filtro antiabbagliamento
Filtre basse luminance
Geringe Leuchtdichte-Filter
Filtro de baja luminancia



SFX2401

Milky screen
Schermo opale
Écran opale
Opal-Bildschirm
Pantalla opal



Note: the filter and the screen must be ordered together with the lighting fixture - **Nota:** il filtro e lo schermo devono essere ordinati congiuntamente all'apparecchio - **Note:** le filtre et l'écran doivent être commandées en même temps que l'appareil
Anmerkung: müssen der Filter und der Bildschirm zusammen mit Leuchtkörper bestellt werden
Nota: el filtro y la pantalla deben pedirse juntos con la luminaria

FRANNY 6

design: Rod&Todd

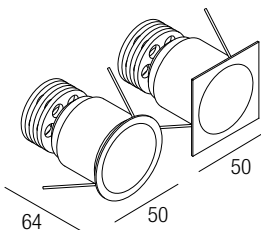

Supply current

Alimentazione
 Courant d'alimentation
 Stromversorgung
 Corriente de alimentación
500 mA (V, 9V)

Power

Potenza
 Pouissance
 Bestuekung
 Potencia
6 W

Series wiring

Cablaggio in serie
 Câblage en série
 Verkabelung in Serie
 Cableado en serie



CCT/CRI/Flux

2700K — 540 lm
 3000K — 600 lm
 4000K — 620 lm

CRI98
 2-Step MacAdam

Photometric diagrams

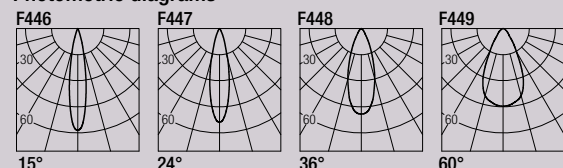

Code Construction

Costruzione del codice - Construction du code produit
 Bau der Produkt-Code - Construcción del código de producto

FN6 X X X X

Beam angle
 Apertura di fascio
 Angle de faisceau
 Strahlwinkel
 Ángulo del haz

N	S	M	W
15°	24°	36°	60°

Color Temperature
 Temperatura colore
 Température couleur
 Temperaturabhängige Farbe
 Temperatura de color

2	3	4
2700K	3000K	4000K

Finishing
 Finitura
 Finitions
 Oberflächenfinish
 Acabados

1	5
White Bianco Blanc Weiß Blanco	Black Nero Noir Schwarz Negro

Shape
 Forma
 Forme
 Form

1	2
Round Tondo Ronde Runde Redondo	Square Quadro Carré Quadrat Cuadrado

Drivers

Alimentatori - Alimentateurs
 Netzteile - Alimentadores

on/off	dimmmable
500 mA	
AL1074 (1..2) 30mm IP20	AL4010 (1..4) 72mm IP20 PUSH 0/1..10V
AL1077 (1..2) 40mm IP20	AL4151 (1..4) 72mm IP20 DALI
AL1084 (1..3) 55mm IP20 S.P.	AL4153 (1..4) 56mm IP20 PUSH IGBT-TRIAC

Accessories

Accessori - Accessoires
 Zubehör - Accesorios

CSFB01

Recessing box
 Controcassa
 Boîtier d'encastrement
 Eingießgehäuse
 Caja de empotrar

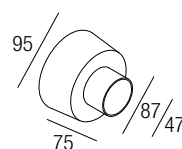

LFN601

Low luminance louver
 Filtro antiabbagliamento
 Filtre basse luminance
 Geringe Leuchtdichte-Filter
 Filtro de baja luminancia



SFN601

Milky screen
 Schermo opale
 Ecran opale
 Opal-Bildschirm
 Pantalla opal



Note: the filter and the screen must be ordered together with the lighting fixture - **Nota:** il filtro e lo schermo devono essere ordinati congiuntamente all'apparecchio - **Note:** le filtre et l'écran doivent être commandées en même temps que l'appareil
Anmerkung: müssen der Filter und der Bildschirm zusammen mit Leuchtkörper bestellt werden
Nota: el filtro y la pantalla deben pedirse juntos con la luminaria

AL7022

24VDC/500mA constant current converter
 Convertitore 24VDC/500mA corrente costante
 Convertisseur 24VDC/500mA courant constant
 24VDC/500mA konstanter Strom konverter
 Convertidor 24VDC/500mA corriente constante



FRANNY 10

design: Rod&Todd

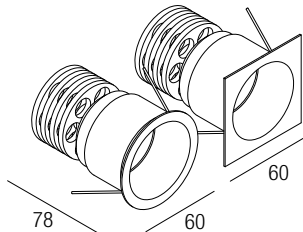

Supply current

Alimentazione
Courant d'alimentation
Stromversorgung
Corriente de alimentación
500 mA (V_I 18V)

Power

Potenza
Pouissance
Bestuekung
Potencia
10 W

Series wiring

Cablaggio in serie
Câblage en série
Verkabelung in Serie
Cableado en serie



Photometric diagrams

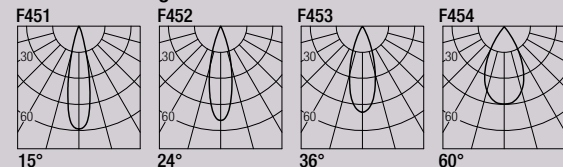

CCT/CRI/Flux

	CRI85	CRI93
2700K	890 lm	840 lm
3000K	1000 lm	930 lm
4000K	1040 lm	960 lm

CRI85 - CRI93
2-Step MacAdam

Code Construction

Costruzione del codice - Construction du code produit
Bau der Produkt-Code - Construcción del código de producto

FN1 X X X X X

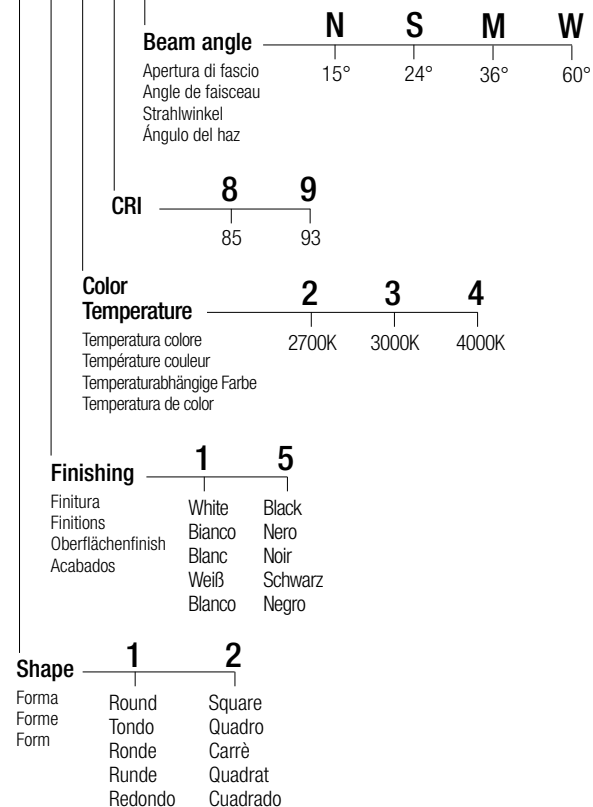

Drivers

Alimentatori - Alimentateurs
Netzteile - Alimentadores

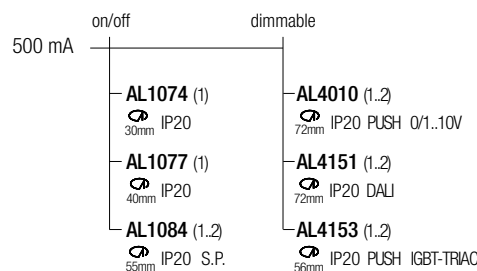

FRANNY 724

design: Rod&Todd

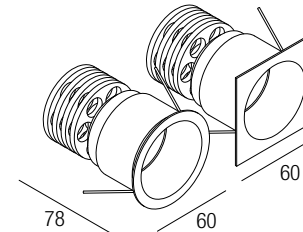

Supply current

Alimentazione
Courant d'alimentation
Stromversorgung
Corriente de alimentación
24 VDC

Power

Potenza
Pouissance
Bestuekung
Potencia
7 W

Parallel wiring

Cablaggio in parallelo
Câblage en parallèle
Verkabelung in parallel
Cableado en paralelo



Photometric diagrams

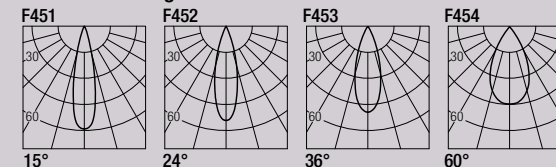

CCT/CRI/Flux

	CRI85	CRI93
2700K	630 lm	590 lm
3000K	700 lm	650 lm
4000K	730 lm	670 lm

CRI85 - CRI93
2-Step MacAdam

Code Construction

Costruzione del codice - Construction du code produit
Bau der Produkt-Code - Construcción del código de producto

FN24 X X X X X

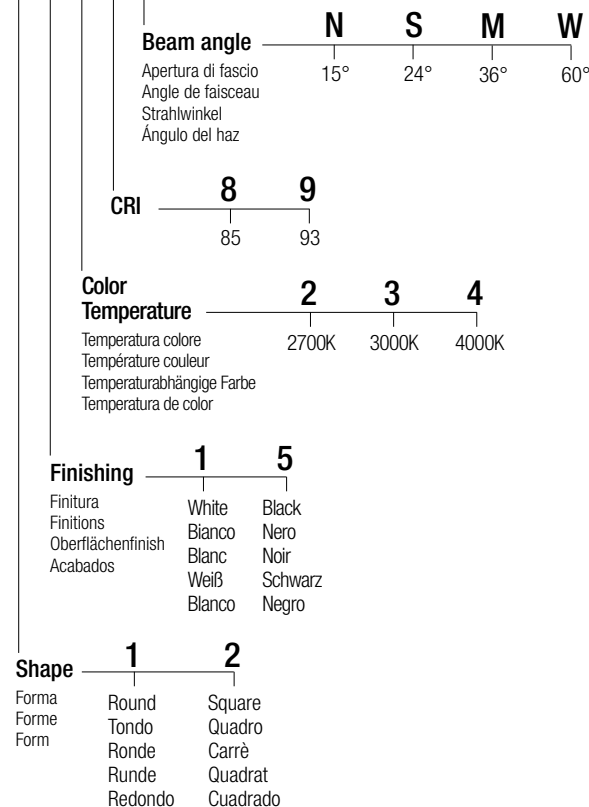

Drivers

Alimentatori - Alimentateurs
Netzteile - Alimentadores

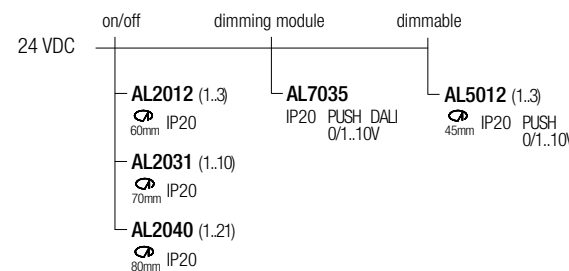

Note: dimming module AL7035 to be used in combination with an on/off 24VDC power supply
Nota: modulo di dimmerazione AL7035 da utilizzare in combinazione con un alimentatore on/off 24VDC
Note: module de variation AL7035 d'intensité à utiliser en combinaison avec une alimentation on/off 24VDC
Anmerkung: Dimmmodul AL7035 zur Verwendung in Kombination mit einem on/off 24VDC-Netzteil
Nota: módulo de regulación AL7035 se utiliza en combinación con una fuente de alimentación on/off 24VDC

Accessories

Accessori - Accessoires
Zubehör - Accesorios

CSFX01

Recessing box
Controcassa
Boîtier d'encastrement
Eingießgehäuse
Caja de empotrar

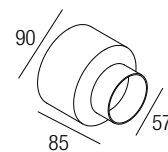

LFN101

Low luminance louver
Filtro antiabbagliamento
Filtre basse luminance
Geringe Leuchtdichte-Filter
Filtro de baja luminancia



SFN101

Milky screen
Schermo opale
Écran opale
Opal-Bildschirm
Pantalla opal



Note: the filter and the screen must be ordered together with the lighting fixture - **Nota:** il filtro e lo schermo devono essere ordinati congiuntamente all'apparecchio - **Note:** le filtre et l'écran doivent être commandées en même temps que l'appareil
Anmerkung: müssen der Filter und der Bildschirm zusammen mit Leuchtkörper bestellt werden
Nota: el filtro y la pantalla deben pedirse juntos con la luminaria

AL7022

24VDC/500mA constant current converter
Convertitore 24VDC/500mA corrente costante
Convertisseur 24VDC/500mA courant constant
24VDC/500mA konstanter Strom konverter
Convertidor 24VDC/500mA corriente constante

Accessories

Accessori - Accessoires
Zubehör - Accesorios

CSFX01

Recessing box
Controcassa
Boîtier d'encastrement
Eingießgehäuse
Caja de empotrar

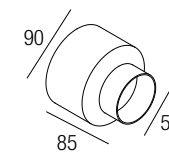

LFN2401

Low luminance louver
Filtro antiabbagliamento
Filtre basse luminance
Geringe Leuchtdichte-Filter
Filtro de baja luminancia



SFN2401

Milky screen
Schermo opale
Écran opale
Opal-Bildschirm
Pantalla opal



Note: the filter and the screen must be ordered together with the lighting fixture - **Nota:** il filtro e lo schermo devono essere ordinati congiuntamente all'apparecchio - **Note:** le filtre et l'écran doivent être commandées en même temps que l'appareil
Anmerkung: müssen der Filter und der Bildschirm zusammen mit Leuchtkörper bestellt werden
Nota: el filtro y la pantalla deben pedirse juntos con la luminaria

ZED

design: Roberto Mantovani

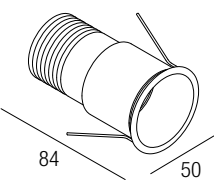

Supply current

Alimentazione
Courant d'alimentation
Stromversorgung
Corriente de alimentación
350-500 mA (V_i 2,9V)

Power

Potenza
Puissance
Bestuekung
Potencia
1-2 W

Series wiring

Cablaggio in serie
Câblage en série
Verkabelung in Serie
Cableado en serie



CCT/CRI/Flux

	350mA	500mA
2700K	89 lm	128 lm
3000K	93 lm	133 lm
4200K	103 lm	154 lm

Photometric diagrams

F445

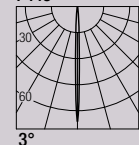

CRI85

2-Step MacAdam

Code Construction

Costruzione del codice - Construction du code produit
Bau der Produkt-Code - Construcción del código de producto

ZD X X 3

Beam angle 3°

Apertura di fascio 3°
Angle de faisceau 3°
Strahlwinkel 3°
Ángulo del haz 3°

Color Temperature

	0	1	2
Temperatura colore	2700K	3000K	4200K
Température couleur			
Temperaturabhängige Farbe			
Temperatura de color			

Finishing

	1	5
Finitura	White	Black
Finitions	Bianco	Nero
Oberflächenfinish	Blanc	Noir
Acabados	Weiß	Schwarz
	Blanco	Negro

Drivers

Alimentatori - Alimentateurs
Netzteile - Alimentadores

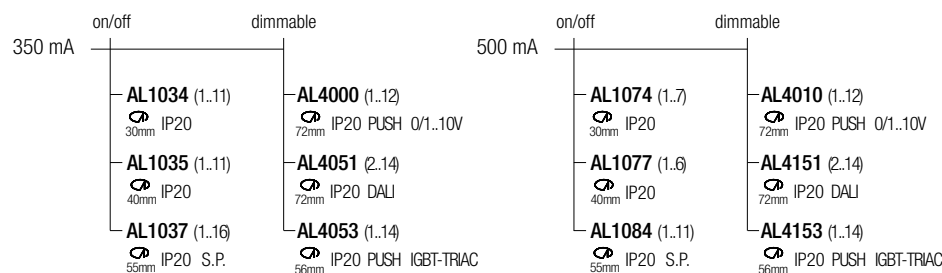

DIDDI

design: Roberto Mantovani

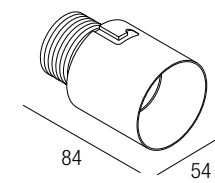

Supply current

Alimentazione
Courant d'alimentation
Stromversorgung
Corriente de alimentación
350-500 mA (V_i 2,9V)

Power

Potenza
Puissance
Bestuekung
Potencia
1-2 W

Series wiring

Cablaggio in serie
Câblage en série
Verkabelung in Serie
Cableado en serie



CCT/CRI/Flux

	350mA	500mA
2700K	89 lm	128 lm
3000K	93 lm	133 lm
4200K	103 lm	154 lm

Photometric diagrams

F445

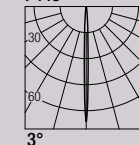

CRI85

2-Step MacAdam

Code Construction

Costruzione del codice - Construction du code produit
Bau der Produkt-Code - Construcción del código de producto

DID X X 3

Beam angle 3°

Apertura di fascio 3°
Angle de faisceau 3°
Strahlwinkel 3°
Ángulo del haz 3°

Color Temperature

	0	1	2
Temperatura colore	2700K	3000K	4200K
Température couleur			
Temperaturabhängige Farbe			
Temperatura de color			

Finishing

	1	5
Finitura	White	Black
Finitions	Bianco	Nero
Oberflächenfinish	Blanc	Noir
Acabados	Weiß	Schwarz
	Blanco	Negro

Drivers

Alimentatori - Alimentateurs
Netzteile - Alimentadores

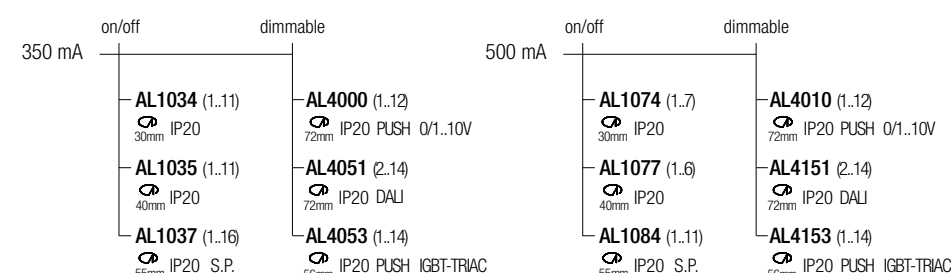

Accessories

Accessori - Accessoires
Zubehör - Accesorios

ZTC10U ZTC10UB

White
Bianco
Blanc
Weiß
Blanco

Black
Nero
Noir
Schwarz
Negro

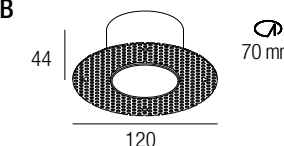

Plasterboard recessing frame
Flangia per cartongesso
Boîtier d'encastrement pour plaques de plâtre
Gehäuses Trockenbau
Cajetín para placas de yeso

LDID01

Low luminance louver
Filtro antiabbagliamento
Filtre basse luminance
Geringe Leuchtdichte-Filter
Filtro de baja luminancia

Note: the filter must be ordered together with the lighting fixture - **Nota:** il filtro deve essere ordinato congiuntamente all'apparecchio - **Note:** le filtre doit être commandé en même temps que l'appareil - **Anmerkung:** muss der Filter zusammen mit Leuchtkörper bestellt werden
Nota: el filtro debe pedirse junto con la luminaria

AL7022

24VDC/500mA constant current converter
Convertitore 24VDC/500mA corrente costante
Convertisseur 24VDC/500mA courant constant
24VDC/500mA konstanter Strom konverter
Convertidor 24VDC/500mA corriente constante

ZOE 6

design: Rod&Todd

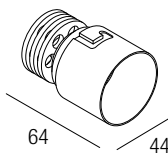

Supply current

Alimentazione
Courant d'alimentation
Stromversorgung
Corriente de alimentación

500 mA (V, 9V)

Power

Potenza
Puissance
Bestuekung
Potencia

6 W

Series wiring

Cablaggio in serie
Câblage en série
Verkabelung in Serie
Cableado en serie



CCT/CRI/Flux

2700K — 540 lm
3000K — 600 lm
4000K — 620 lm

Photometric diagrams

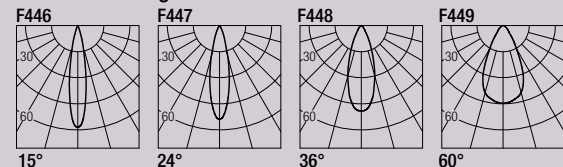

CRI98
2-Step MacAdam

Code Construction

Costruzione del codice - Construction du code produit
Bau der Produkt-Code - Construcción del código de producto

ZE6 X, X, X

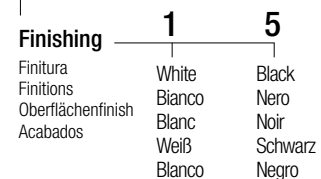
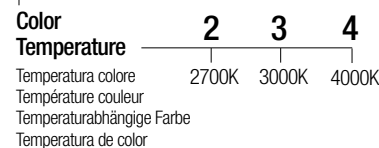
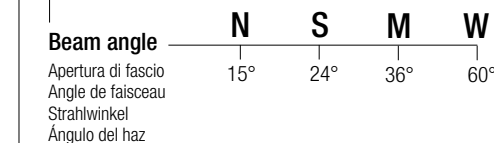

Accessories

Accessori - Accessoires
Zubehör - Accesorios

ZQH001 ZQH001B

White
Bianco
Blanc
Weiß
Blanco

Black
Nero
Noir
Schwarz
Negro

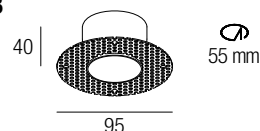

Plasterboard recessing frame
Flangia per cartongesso
Boîtier d'encastrement pour plaques de plâtre
Gehäuses Trockenbau
Cajetín para placas de yeso

LZE601

Low luminance louver
Filtro antiabbagliamento
Filtre basse luminance
Geringe Leuchtdichte-Filter
Filtro de baja luminancia

SZE601

Milky screen
Schermo opale
Écran opale
Opal-Bildschirm
Pantalla opal

Note: the filter and the screen must be ordered together with the lighting fixture - **Nota:** il filtro e lo schermo devono essere ordinati congiuntamente all'apparecchio - **Note:** le filtre et l'écran doivent être commandées en même temps que l'appareil
Anmerkung: müssen der Filter und der Bildschirm zusammen mit Leuchtkörper bestellt werden
Nota: el filtro y la pantalla deben pedirse juntos con la luminaria

AL7022

24VDC/500mA constant current converter
Convertitore 24VDC/500mA corrente costante
Convertisseur 24VDC/500mA courant constant
24VDC/500mA konstanter Strom konverter
Convertidor 24VDC/500mA corriente constante

Drivers

Alimentatori - Alimentateurs
Netzteile - Alimentadores

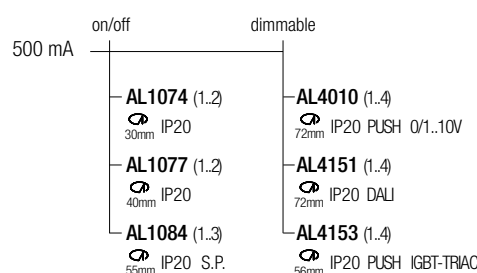

ZOE 10

design: Rod&Todd

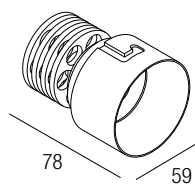

Supply current

Alimentazione
Courant d'alimentation
Stromversorgung
Corriente de alimentación
500 mA (V, 18V)

Power

Potenza
Puissance
Bestuekung
Potencia
10 W

Series wiring

Cablaggio in serie
Câblage en série
Verkabelung in Serie
Cableado en serie



Photometric diagrams

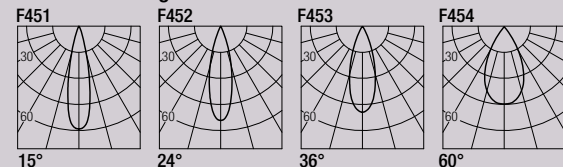

CCT/CRI/Flux

	CRI85	CRI93
2700K	890 lm	840 lm
3000K	1000 lm	930 lm
4000K	1040 lm	960 lm

CRI85 - CRI93

2-Step MacAdam

Code Construction

Costruzione del codice - Construction du code produit
Bau der Produkt-Code - Construcción del código de producto

ZE1 X X X X

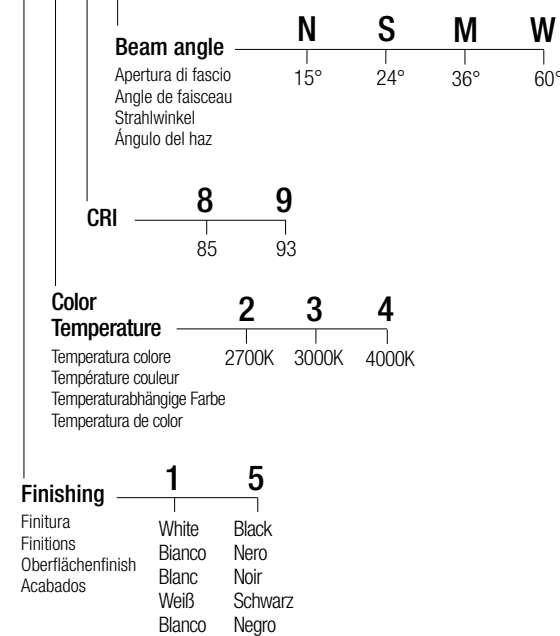

Drivers

Alimentatori - Alimentateurs
Netzteile - Alimentadores

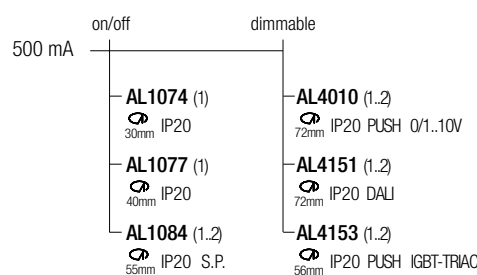

ZOE 724

design: Rod&Todd

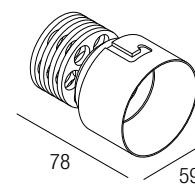

Supply current

Alimentazione
Courant d'alimentation
Stromversorgung
Corriente de alimentación
24 VDC

Power

Potenza
Puissance
Bestuekung
Potencia
7 W

Parallel wiring

Cablaggio in parallelo
Câblage en parallèle
Verkabelung in parallel
Cableado en paralelo



Photometric diagrams

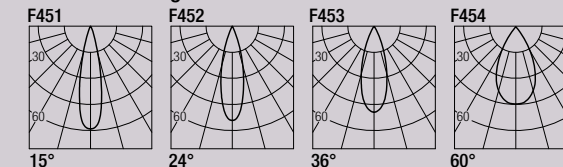

CCT/CRI/Flux

	CRI85	CRI93
2700K	630 lm	590 lm
3000K	700 lm	650 lm
4000K	730 lm	670 lm

CRI85 - CRI93

2-Step MacAdam

Code Construction

Costruzione del codice - Construction du code produit
Bau der Produkt-Code - Construcción del código de producto

ZE24 X X X X

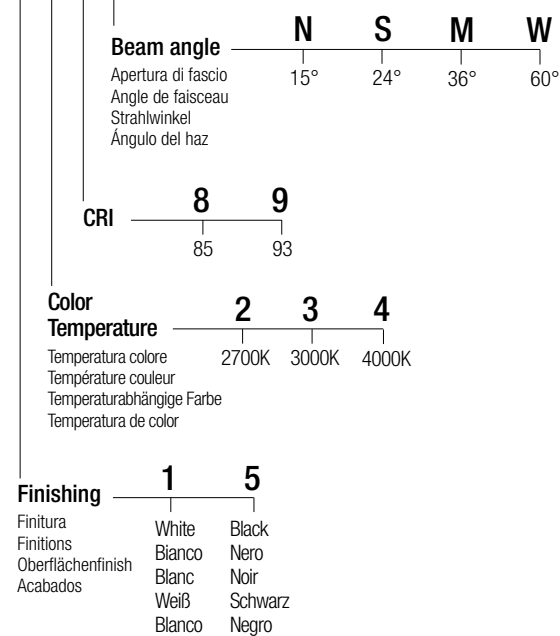

Drivers

Alimentatori - Alimentateurs
Netzteile - Alimentadores

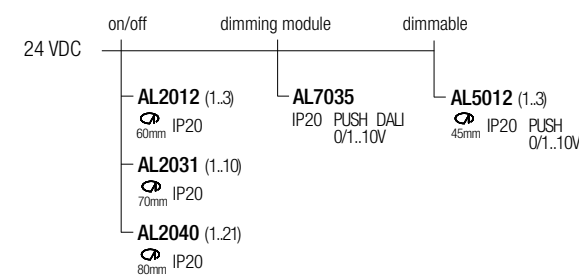

Note: dimming module AL7035 to be used in combination with an on/off 24VDC power supply
Nota: modulo di dimmerazione AL7035 da utilizzare in combinazione con un alimentatore on/off 24VDC
Note: module de variation AL7035 d'intensité à utiliser en combinaison avec une alimentation on/off 24VDC
Anmerkung: Dimmmodul AL7035 zur Verwendung in Kombination mit einem on/off 24VDC-Netzteil
Nota: módulo de regulación AL7035 se utiliza en combinación con una fuente de alimentación on/off 24VDC

Accessories

Accessori - Accessoires
Zubehör - Accesorios

ZQC003 ZQC003B

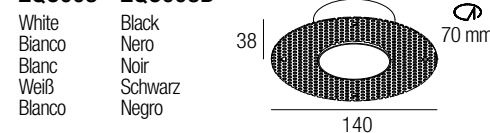

Plasterboard recessing frame
Flangia per cartongesso
Boîtier d'encastrement pour plaques de plâtre
Gehäuses Trockenbau
Cajetin para placas de yeso

LZE101

Low luminance louver
Filtro antiabbagliamento
Filtre basse luminance
Geringe Leuchtdichte-Filter
Filtro de baja luminancia

SZE101

Milky screen
Schermo opale
Écran opale
Opal-Bildschirm
Pantalla opal

Note: the filter and the screen must be ordered together with the lighting fixture - **Nota:** il filtro e lo schermo devono essere ordinati congiuntamente all'apparecchio - **Note:** le filtre et l'écran doivent être commandées en même temps que l'appareil
Anmerkung: müssen der Filter und der Bildschirm zusammen mit Leuchtkörper bestellt werden
Nota: el filtro y la pantalla deben pedirse juntos con la luminaria

AL7022

24VDC/500mA constant current converter
Convertitore 24VDC/500mA corrente costante
Convertisseur 24VDC/500mA courant constant
24VDC/500mA konstanter Strom konverter
Convertidor 24VDC/500mA corriente constante

ZOE 724

design: Rod&Todd



Supply current

Alimentazione
Courant d'alimentation
Stromversorgung
Corriente de alimentación
24 VDC

Power

Potenza
Puissance
Bestuekung
Potencia
7 W

Parallel wiring

Cablaggio in parallelo
Câblage en parallèle
Verkabelung in parallel
Cableado en paralelo



Photometric diagrams



Accessories

Accessori - Accessoires
Zubehör - Accesorios

ZQC003 ZQC003B

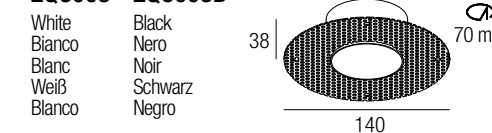

Plasterboard recessing frame
Flangia per cartongesso
Boîtier d'encastrement pour plaques de plâtre
Gehäuses Trockenbau
Cajetin para placas de yeso

LZE2401

Low luminance louver
Filtro antiabbagliamento
Filtre basse luminance
Geringe Leuchtdichte-Filter
Filtro de baja luminancia

SZE2401

Milky screen
Schermo opale
Écran opale
Opal-Bildschirm
Pantalla opal

Note: the filter and the screen must be ordered together with the lighting fixture - **Nota:** il filtro e lo schermo devono essere ordinati congiuntamente all'apparecchio - **Note:** le filtre et l'écran doivent être commandées en même temps que l'appareil
Anmerkung: müssen der Filter und der Bildschirm zusammen mit Leuchtkörper bestellt werden
Nota: el filtro y la pantalla deben pedirse juntos con la luminaria

SEXUS 6

design: Rod&Todd

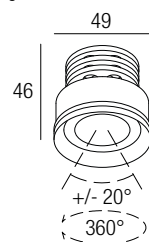

Supply current

Alimentazione
Courant d'alimentation
Stromversorgung
Corriente de alimentación

500 mA (V, 9V)

Power

Potenza
Puissance
Bestuekung
Potencia

6 W

Series wiring

Cablaggio in serie
Câblage en série
Verkabelung in Serie
Cableado en serie



Photometric diagrams

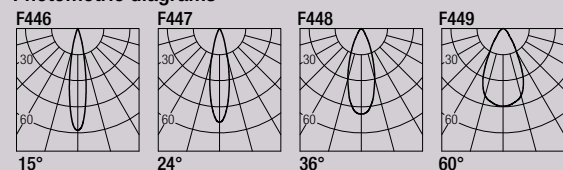

CCT/CRI/Flux

2700K — 540 lm
3000K — 600 lm
4000K — 620 lm

CRI98

2-Step MacAdam

Code Construction

Costruzione del codice - Construction du code produit
Bau der Produkt-Code - Construcción del código de producto

SX6 X X X

Beam angle

	N	S	M	W
Apertura di fascio	15°	24°	36°	60°
Angle de faisceau	15°	24°	36°	60°
Strahlwinkel	15°	24°	36°	60°
Ángulo del haz	15°	24°	36°	60°

Color Temperature

	2	3	4
Temperatura colore	2700K	3000K	4000K
Température couleur	2700K	3000K	4000K
Temperaturabhängige Farbe	2700K	3000K	4000K
Temperatura de color	2700K	3000K	4000K

Finishing

	1	5
Finitura	White	Black
Finitions	Bianco	Nero
Oberflächenfinish	Blanc	Noir
Acabados	Weiß	Schwarz
	Blanco	Negro

Accessories

Accessori - Accessoires
Zubehör - Accesorios

ZQS001 ZQS001B

White	Black
Bianco	Nero
Blanc	Noir
Weiß	Schwarz
Blanco	Negro

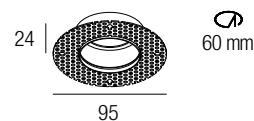

Plasterboard recessing frame
Flangia per cartongesso
Boîtier d'encastrement pour plaques de plâtre
Gehäuses Trockenbau
Cajetín para placas de yeso

LSX601

Low luminance louver
Filtro antiabbagliamento
Filtre basse luminance
Geringe Leuchtdichte-Filter
Filtro de baja luminancia

SSX601

Milky screen
Schermo opale
Écran opale
Opal-Bildschirm
Pantalla opal

Note: the filter and the screen must be ordered together with the lighting fixture - **Nota:** il filtro e lo schermo devono essere ordinati congiuntamente all'apparecchio - **Note:** le filtre et l'écran doivent être commandées en même temps que l'appareil
Anmerkung: müssen der Filter und der Bildschirm zusammen mit Leuchtkörper bestellt werden
Nota: el filtro y la pantalla deben pedirse juntos con la luminaria

AL7022

24VDC/500mA constant current converter
Convertitore 24VDC/500mA corrente costante
Convertisseur 24VDC/500mA courant constant
24VDC/500mA konstanter Strom konverter
Convertidor 24VDC/500mA corriente constante

Drivers

Alimentatori - Alimentateurs
Netzteile - Alimentadores

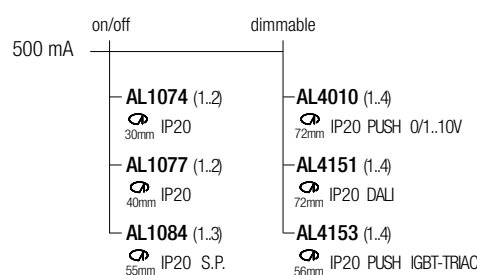

SEXUS 10

design: Rod&Todd

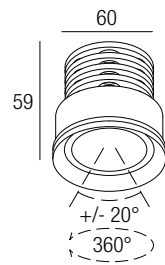

Supply current

Alimentazione
Courant d'alimentation
Stromversorgung
Corriente de alimentación
500 mA (V, 18V)

Power

Potenza
Puissance
Bestuekung
Potencia
10 W

Series wiring

Cablaggio in serie
Câblage en série
Verkabelung in Serie
Cableado en serie



Photometric diagrams

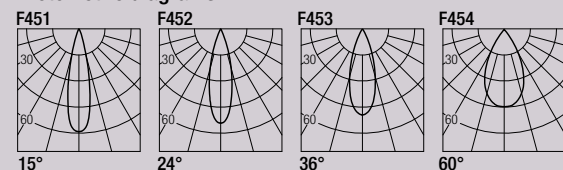

CCT/CRI/Flux

	CRI85	CRI93
2700K	890 lm	840 lm
3000K	1000 lm	930 lm
4000K	1040 lm	960 lm

CRI85 - CRI93

2-Step MacAdam

Code Construction

Costruzione del codice - Construction du code produit
Bau der Produkt-Code - Construcción del código de producto

SX1 X X X X

Beam angle N S M W
Apertura di fascio 15° 24° 36° 60°
Angle de faisceau
Strahlwinkel
Ángulo del haz

CRI 8 9
85 93

Color Temperature 2 3 4
Temperatura colore 2700K 3000K 4000K
Température couleur
Temperaturabhängige Farbe
Temperatura de color

Finishing 1 5
Finitura White Black
Finitions Bianco Nero
Oberflächenfinish Blanc Noir
Acabados Weiß Schwarz
Blanco Negro

Drivers

Alimentatori - Alimentateurs
Netzteile - Alimentadores

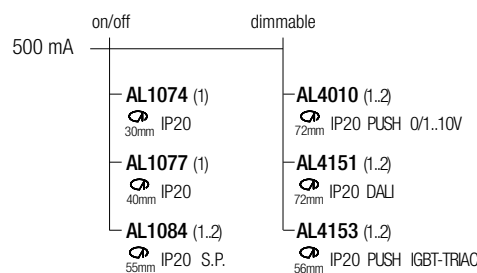

SEXUS 724

design: Rod&Todd

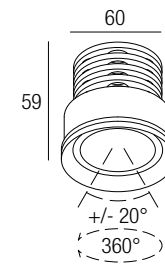

Supply current

Alimentazione
Courant d'alimentation
Stromversorgung
Corriente de alimentación
24 VDC

Power

Potenza
Puissance
Bestuekung
Potencia
7 W

Parallel wiring

Cablaggio in parallelo
Câblage en parallèle
Verkabelung in parallel
Cableado en paralelo



Photometric diagrams

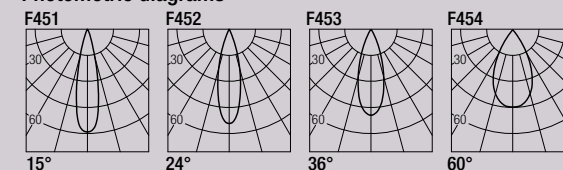

CCT/CRI/Flux

	CRI85	CRI93
2700K	630 lm	590 lm
3000K	700 lm	650 lm
4000K	730 lm	670 lm

CRI85 - CRI93

2-Step MacAdam

Code Construction

Costruzione del codice - Construction du code produit
Bau der Produkt-Code - Construcción del código de producto

SX24 X X X X

Beam angle N S M W
Apertura di fascio 15° 24° 36° 60°
Angle de faisceau
Strahlwinkel
Ángulo del haz

CRI 8 9
85 93

Color Temperature 2 3 4
Temperatura colore 2700K 3000K 4000K
Température couleur
Temperaturabhängige Farbe
Temperatura de color

Finishing 1 5
Finitura White Black
Finitions Bianco Nero
Oberflächenfinish Blanc Noir
Acabados Weiß Schwarz
Blanco Negro

Drivers

Alimentatori - Alimentateurs
Netzteile - Alimentadores

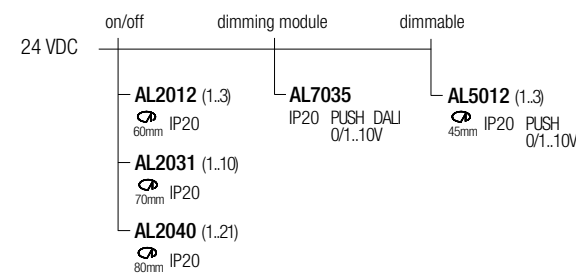

Note: dimming module AL7035 to be used in combination with an on/off 24VDC power supply
Nota: modulo di dimmerazione AL7035 da utilizzare in combinazione con un alimentatore on/off 24VDC
Note: module de variation AL7035 d'intensité à utiliser en combinaison avec une alimentation on/off 24VDC
Anmerkung: Dimmmodul AL7035 zur Verwendung in Kombination mit einem on/off 24VDC-Netzteil
Nota: módulo de regulación AL7035 se utiliza en combinación con una fuente de alimentación on/off 24VDC

Accessories

Accessori - Accessoires
Zubehör - Accesorios

ZQS002 ZQS002B

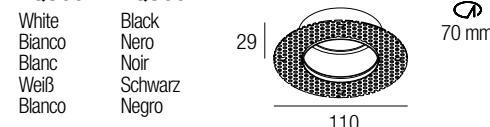

Plasterboard recessing frame
Flangia per cartongesso
Boîtier d'encastrement pour plaques de plâtre
Gehäuses Trockenbau
Cajetín para placas de yeso

LSX101

Low luminance louver
Filtro antiabbagliamento
Filtre basse luminance
Geringe Leuchtdichte-Filter
Filtro de baja luminancia

SSX101

Milky screen
Schermo opale
Écran opale
Opal-Bildschirm
Pantalla opal

Note: the filter and the screen must be ordered together with the lighting fixture - **Nota:** il filtro e lo schermo devono essere ordinati congiuntamente all'apparecchio - **Note:** le filtre et l'écran doivent être commandées en même temps que l'appareil
Anmerkung: müssen der Filter und der Bildschirm zusammen mit Leuchtkörper bestellt werden
Nota: el filtro y la pantalla deben pedirse juntos con la luminaria

AL7022

24VDC/500mA constant current converter
Convertitore 24VDC/500mA corrente costante
Convertisseur 24VDC/500mA courant constant
24VDC/500mA konstanter Strom konverter
Convertidor 24VDC/500mA corriente constante

Accessories

Accessori - Accessoires
Zubehör - Accesorios

ZQS002 ZQS002B

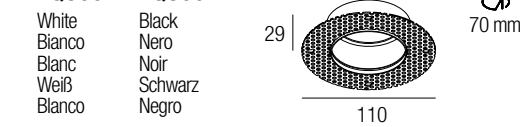

Plasterboard recessing frame
Flangia per cartongesso
Boîtier d'encastrement pour plaques de plâtre
Gehäuses Trockenbau
Cajetín para placas de yeso

LSX2401

Low luminance louver
Filtro antiabbagliamento
Filtre basse luminance
Geringe Leuchtdichte-Filter
Filtro de baja luminancia

SSX2401

Milky screen
Schermo opale
Écran opale
Opal-Bildschirm
Pantalla opal

Note: the filter and the screen must be ordered together with the lighting fixture - **Nota:** il filtro e lo schermo devono essere ordinati congiuntamente all'apparecchio - **Note:** le filtre et l'écran doivent être commandées en même temps que l'appareil
Anmerkung: müssen der Filter und der Bildschirm zusammen mit Leuchtkörper bestellt werden
Nota: el filtro y la pantalla deben pedirse juntos con la luminaria

SEXUS 6 UGR

design: Rod&Todd

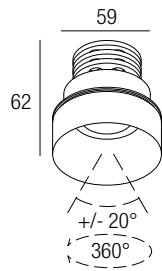

Supply current

Alimentazione
Courant d'alimentation
Stromversorgung
Corriente de alimentación
500 mA (V, 9V)

Power

Potenza
Puissance
Bestuekung
Potencia
6 W

Series wiring

Cablaggio in serie
Câblage en série
Verkabelung in Serie
Cableado en serie



CCT/CRI/Flux

2700K — 540 lm
3000K — 600 lm
4000K — 620 lm

CRI98
2-Step MacAdam

Photometric diagrams

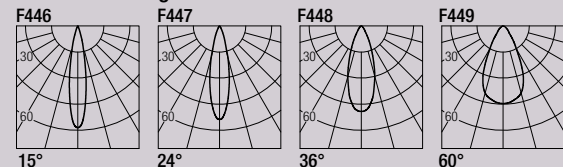

Code Construction

Costruzione del codice - Construction du code produit
Bau der Produkt-Code - Construcción del código de producto

SXU6 X X X

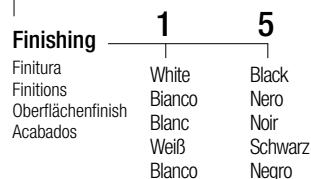
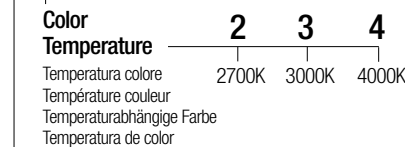
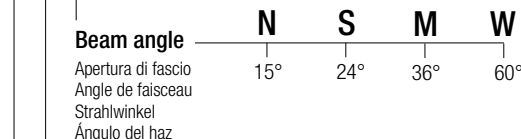

Drivers

Alimentatori - Alimentateurs
Netzteile - Alimentadores

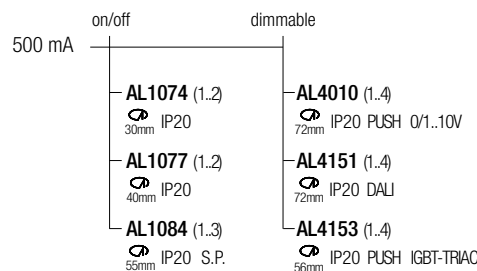

SEXUS 10 UGR

design: Rod&Todd

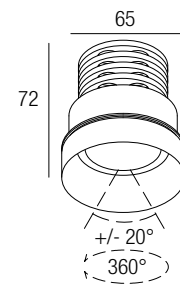

Supply current

Alimentazione
Courant d'alimentation
Stromversorgung
Corriente de alimentación
500 mA (V, 18V)

Power

Potenza
Puissance
Bestuekung
Potencia
10 W

Series wiring

Cablaggio in serie
Câblage en série
Verkabelung in Serie
Cableado en serie



CCT/CRI/Flux

CRI85 CRI93
2700K — 890 lm 840 lm
3000K — 1000 lm 930 lm
4000K — 1040 lm 960 lm

CRI85 - CRI93
2-Step MacAdam

Photometric diagrams

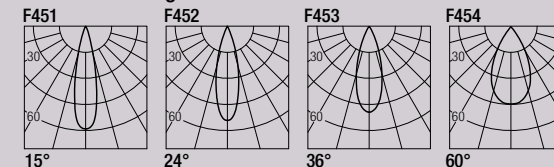

Code Construction

Costruzione del codice - Construction du code produit
Bau der Produkt-Code - Construcción del código de producto

SXU1 X X X X

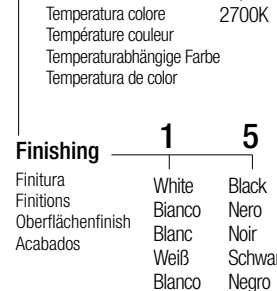
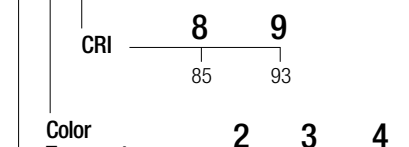
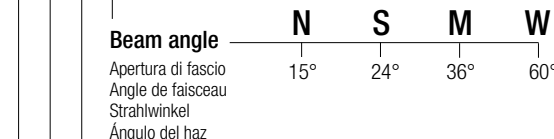

Drivers

Alimentatori - Alimentateurs
Netzteile - Alimentadores

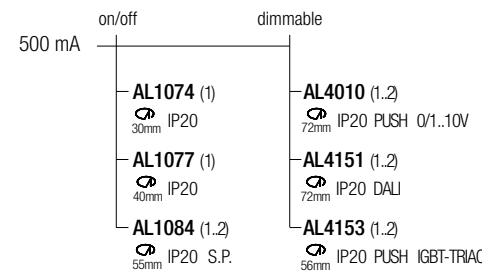

Accessories

Accessori - Accessoires
Zubehör - Accesorios

ZQSU002 ZQSU002B

White
Bianco
Blanc
Weiß
Blanco

Black
Nero
Noir
Schwarz
Negro

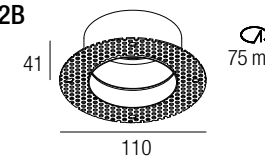

Plasterboard recessing frame
Flangia per cartongesso
Boîtier d'encastrement pour plaques de plâtre
Gehäuses Trockenbau
Cajetín para placas de yeso

LSXU101

Low luminance louver
Filtro antiabbagliamento
Filtre basse luminance
Geringe Leuchtdichte-Filter
Filtro de baja luminancia

SSXU101

Milky screen
Schermo opale
Écran opale
Opal-Bildschirm
Pantalla opal

Note: the filter and the screen must be ordered together with the lighting fixture - **Nota:** il filtro e lo schermo devono essere ordinati congiuntamente all'apparecchio - **Note:** le filtre et l'écran doivent être commandées en même temps que l'appareil
Anmerkung: müssen der Filter und der Bildschirm zusammen mit Leuchtkörper bestellt werden
Nota: el filtro y la pantalla deben pedirse juntos con la luminaria

AL7022

24VDC/500mA constant current converter
Convertitore 24VDC/500mA corrente costante
Convertisseur 24VDC/500mA courant constant
24VDC/500mA konstanter Strom konverter
Convertidor 24VDC/500mA corriente constante

SEXUS 724 UGR

design: Rod&Todd

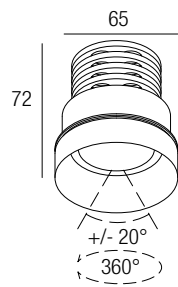

Supply current

Alimentazione
Courant d'alimentation
Stromversorgung
Corriente de alimentación
24 VDC

Power

Potenza
Puissance
Bestuekung
Potencia
7 W

Parallel wiring

Cablaggio in parallelo
Câblage en parallèle
Verkabelung in parallel
Cableado en paralelo



Photometric diagrams

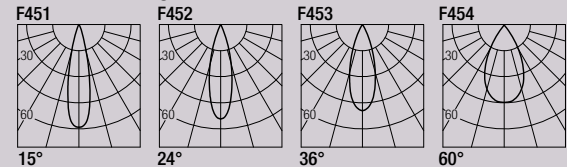

CCT/CRI/Flux

	CRI85	CRI93
2700K	630 lm	590 lm
3000K	700 lm	650 lm
4000K	730 lm	670 lm

CRI85 - CRI93
2-Step MacAdam

Code Construction

Costruzione del codice - Construction du code produit
Bau der Produkt-Code - Construcción del código de producto

SXU24 X X X X

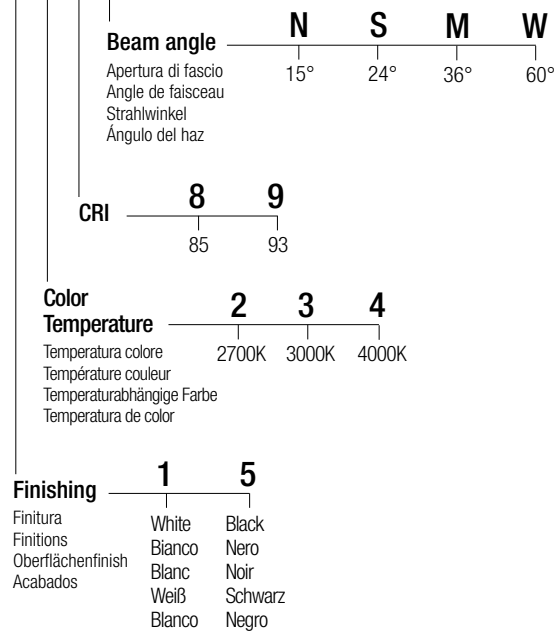

Drivers

Alimentatori - Alimentateurs
Netzteile - Alimentadores

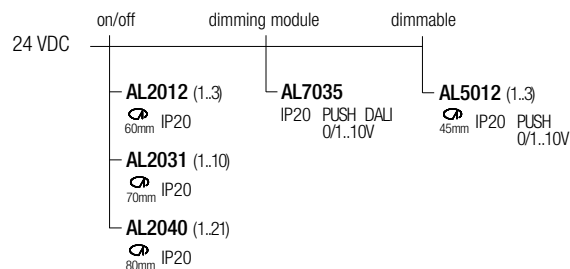

Note: dimming module AL7035 to be used in combination with an on/off 24VDC power supply
Nota: modulo di dimmerazione AL7035 da utilizzare in combinazione con un alimentatore on/off 24VDC
Note: module de variation AL7035 d'intensité à utiliser en combinaison avec une alimentation on/off 24VDC
Anmerkung: Dimmmodul AL7035 zur Verwendung in Kombination mit einem on/off 24VDC-Netzteil
Nota: módulo de regulación AL7035 se utiliza en combinación con una fuente de alimentación on/off 24VDC

- DATASHEET
- INSTALLATION MANUAL
- CERTIFICATIONS
- LDT-IES
- DRAWINGS

PLEXUS 6

design: Rod&Todd

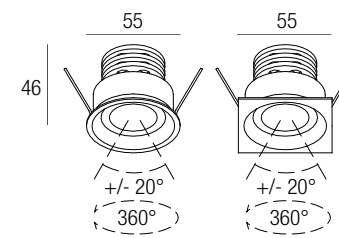

Supply current

Alimentazione
Courant d'alimentation
Stromversorgung
Corriente de alimentación
500 mA (V, 9V)

Power

Potenza
Puissance
Bestuekung
Potencia
6 W

Series wiring

Cablaggio in serie
Câblage en série
Verkabelung in Serie
Cableado en serie



Photometric diagrams

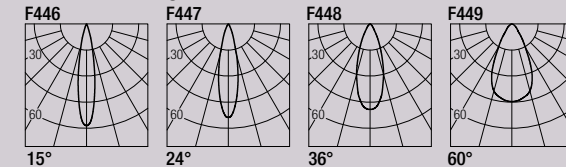

CCT/CRI/Flux

2700K	540 lm
3000K	600 lm
4000K	620 lm

CRI98
2-Step MacAdam

Code Construction

Costruzione del codice - Construction du code produit
Bau der Produkt-Code - Construcción del código de producto

PLX6 X X X X

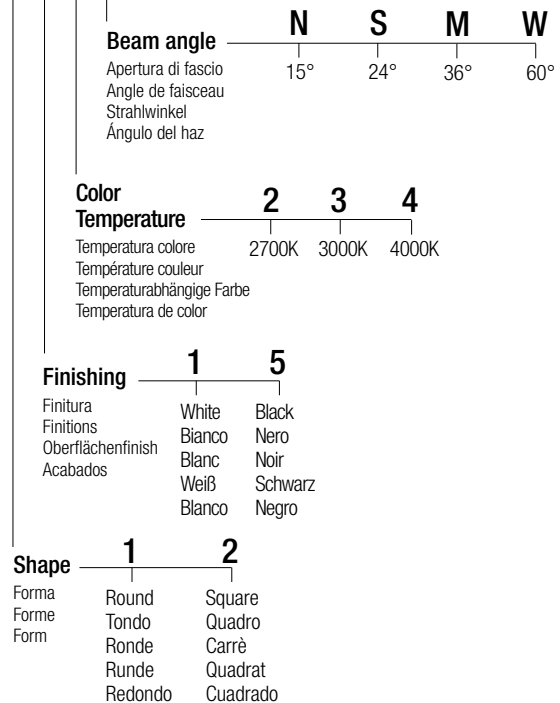

Drivers

Alimentatori - Alimentateurs
Netzteile - Alimentadores

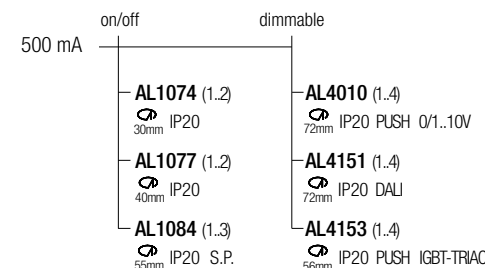

Accessories

Accessori - Accessoires
Zubehör - Accesorios

ZQS002 ZQS002B

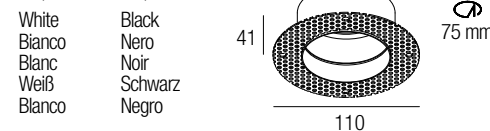

Plasterboard recessing frame
Flangia per cartongesso
Boîtier d'encastrement pour plaques de plâtre
Gehäuses Trockenbau
Cajetín para placas de yeso

LSXU2401

Low luminance louver
Filtro antiabagliamento
Filtre basse luminance
Geringe Leuchtdichte-Filter
Filtro de baja luminancia

SSXU2401

Milky screen
Schermo opale
Écran opale
Opal-Bildschirm
Pantalla opal

Note: the filter and the screen must be ordered together with the lighting fixture - **Nota:** il filtro e lo schermo devono essere ordinati congiuntamente all'apparecchio - **Note:** le filtre et l'écran doivent être commandées en même temps que l'appareil
Anmerkung: müssen der Filter und der Bildschirm zusammen mit Leuchtkörper bestellt werden
Nota: el filtro y la pantalla deben pedirse juntos con la luminaria

- DATASHEET
- INSTALLATION MANUAL
- CERTIFICATIONS
- LDT-IES
- DRAWINGS

Accessories

Accessori - Accessoires
Zubehör - Accesorios

LPLX601

Low luminance louver
Filtro antiabagliamento
Filtre basse luminance
Geringe Leuchtdichte-Filter
Filtro de baja luminancia

SPLX601

Milky screen
Schermo opale
Écran opale
Opal-Bildschirm
Pantalla opal

Note: the filter and the screen must be ordered together with the lighting fixture - **Nota:** il filtro e lo schermo devono essere ordinati congiuntamente all'apparecchio - **Note:** le filtre et l'écran doivent être commandées en même temps que l'appareil
Anmerkung: müssen der Filter und der Bildschirm zusammen mit Leuchtkörper bestellt werden
Nota: el filtro y la pantalla deben pedirse juntos con la luminaria

AL7022

24VDC/500mA constant current converter
Convertitore 24VDC/500mA corrente costante
Convertisseur 24VDC/500mA courant constant
24VDC/500mA konstanter Strom konverter
Convertidor 24VDC/500mA corriente constante

PLEXUS 10

design: Rod&Todd

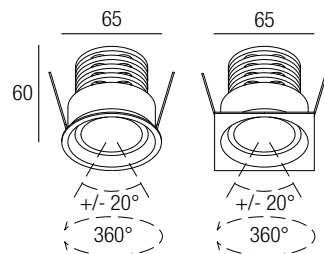

Supply current

Alimentazione
Courant d'alimentation
Stromversorgung
Corriente de alimentación
500 mA (V_I 18V)

Power

Potenza
Puissance
Bestuekung
Potencia
10 W

Series wiring

Cablaggio in serie
Câblage en série
Verkabelung in Serie
Cableado en serie



Photometric diagrams

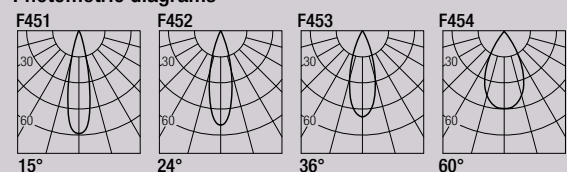

CCT/CRI/Flux

	CRI85	CRI93
2700K	890 lm	840 lm
3000K	1000 lm	930 lm
4000K	1040 lm	960 lm

CRI85 - CRI93

2-Step MacAdam

Code Construction

Costruzione del codice - Construction du code produit
Bau der Produkt-Code - Construcción del código de producto

PLX1 X X X X X

Beam angle
Apertura di fascio
Angle de faisceau
Strahlwinkel
Ángulo del haz

N	S	M	W
15°	24°	36°	60°

CRI

8	9
85	93

Color Temperature
Temperatura colore
Température couleur
Temperaturabhängige Farbe
Temperatura de color

2	3	4
2700K	3000K	4000K

Finishing

1	5
White	Black
Bianco	Nero
Blanc	Noir
Weiß	Schwarz
Blanco	Negro

Shape

1	2
Round	Square
Tondo	Quadro
Ronde	Carrè
Runde	Quadrat
Redondo	Cuadrado

Drivers

Alimentatori - Alimentateurs
Netzteile - Alimentadores

on/off	dimmable
AL1074 (1) 30mm IP20	AL4010 (1,2) 72mm IP20 PUSH 0/1..10V
AL1077 (1) 40mm IP20	AL4151 (1,2) 72mm IP20 DALI
AL1084 (1,2) 50mm IP20 S.P.	AL4153 (1,2) 56mm IP20 PUSH IGBT-TRIAC

Accessories

Accessori - Accessoires
Zubehör - Accesorios

LPLX101

Low luminance louver
Filtro antiabbagliamento
Filtre basse luminance
Geringe Leuchtdichte-Filter
Filtro de baja luminancia

SPLX101

Milky screen
Schermo opale
Écran opale
Opal-Bildschirm
Pantalla opal

Note: the filter and the screen must be ordered together with the lighting fixture - **Nota:** il filtro e lo schermo devono essere ordinati congiuntamente all'apparecchio - **Note:** le filtre et l'écran doivent être commandées en même temps que l'appareil
Anmerkung: müssen der Filter und der Bildschirm zusammen mit Leuchtkörper bestellt werden
Nota: el filtro y la pantalla deben pedirse juntos con la luminaria

AL7022

24VDC/500mA constant current converter
Convertitore 24VDC/500mA corrente costante
Convertisseur 24VDC/500mA courant constant
24VDC/500mA konstanter Strom konverter
Convertidor 24VDC/500mA corriente constante



PLEXUS 724

design: Rod&Todd

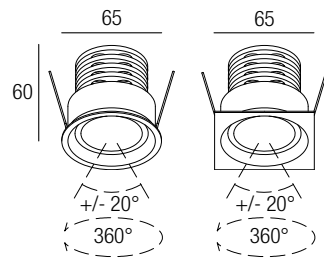

Supply current

Alimentazione
 Courant d'alimentation
 Stromversorgung
 Corriente de alimentación
24 VDC

Power

Potenza
 Pouissance
 Bestuekung
 Potencia
7 W

Parallel wiring

Cablaggio in parallelo
 Câblage en parallèle
 Verkabelung in parallel
 Cableado en paralelo



Photometric diagrams

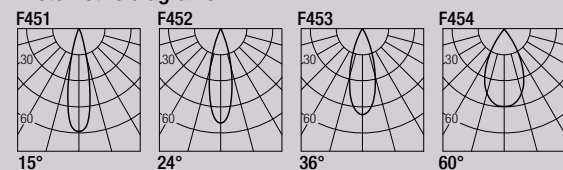

CCT/CRI/Flux

	CRI85	CRI93
2700K	630 lm	590 lm
3000K	700 lm	650 lm
4000K	730 lm	670 lm

CRI85 - CRI93
 2-Step MacAdam

Code Construction

Costruzione del codice - Construction du code produit
 Bau der Produkt-Code - Construcción del código de producto

PLX24 X X X X X

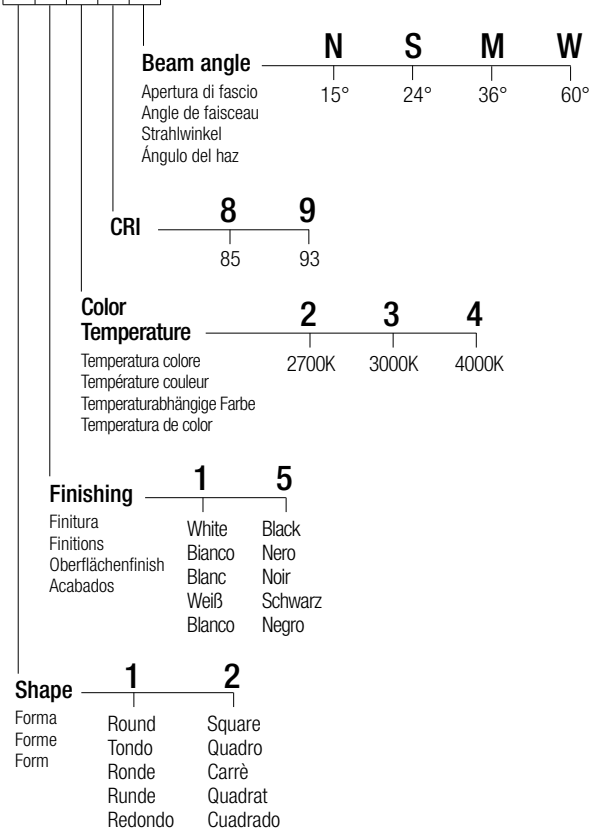

Drivers

Alimentatori - Alimentateurs
 Netzteile - Alimentadores

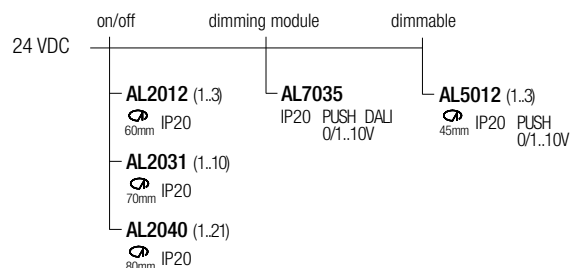

Note: dimming module AL7035 to be used in combination with an on/off 24VDC power supply
Nota: modulo di dimmerazione AL7035 da utilizzare in combinazione con un alimentatore on/off 24VDC
Note: module de variation AL7035 d'intensité à utiliser en combinaison avec une alimentation on/off 24VDC
Anmerkung: Dimmmodul AL7035 zur Verwendung in Kombination mit einem on/off 24VDC-Netzteil
Nota: módulo de regulación AL7035 se utiliza en combinación con una fuente de alimentación on/off 24VDC

Accessories

Accessori - Accessoires
 Zubehör - Accesorios

LPLX2401

Low luminance louver
 Filtro antiabbagliamento
 Filtre basse luminance
 Geringe Leuchtdichte-Filter
 Filtro de baja luminancia

SPLX2401

Milky screen
 Schermo opale
 Écran opale
 Opal-Bildschirm
 Pantalla opal

Note: the filter and the screen must be ordered together with the lighting fixture - **Nota:** il filtro e lo schermo devono essere ordinati congiuntamente all'apparecchio - **Note:** le filtre et l'écran doivent être commandées en même temps que l'appareil
Anmerkung: müssen der Filter und der Bildschirm zusammen mit Leuchtkörper bestellt werden
Nota: el filtro y la pantalla deben pedirse juntos con la luminaria

PLEXUS 6 UGR

design: Rod&Todd

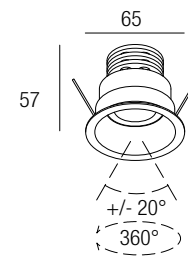

Supply current

Alimentazione
 Courant d'alimentation
 Stromversorgung
 Corriente de alimentación
500 mA (V_i 9V)

Power

Potenza
 Pouissance
 Bestuekung
 Potencia
6 W

Series wiring

Cablaggio in serie
 Câblage en série
 Verkabelung in Serie
 Cableado en serie



Photometric diagrams

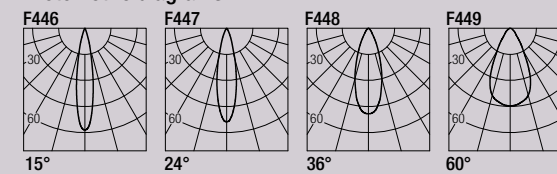

CCT/CRI/Flux

2700K	540 lm
3000K	600 lm
4000K	620 lm

CRI98
 2-Step MacAdam

Code Construction

Costruzione del codice - Construction du code produit
 Bau der Produkt-Code - Construcción del código de producto

PLXU6 X X X

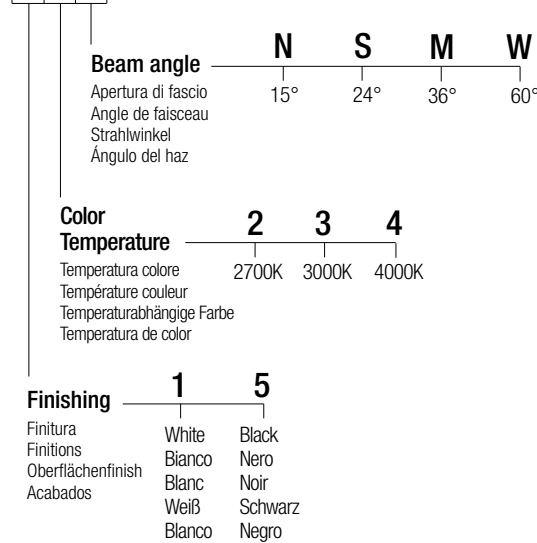

Drivers

Alimentatori - Alimentateurs
 Netzteile - Alimentadores

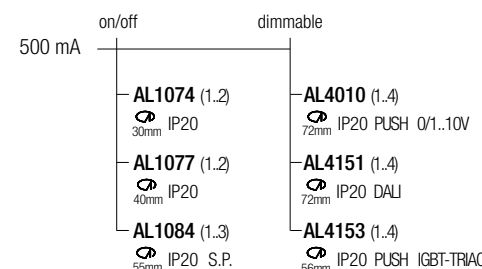

Accessories

Accessori - Accessoires
 Zubehör - Accesorios

LPLXU601

Low luminance louver
 Filtro antiabbagliamento
 Filtre basse luminance
 Geringe Leuchtdichte-Filter
 Filtro de baja luminancia

SPLXU601

Milky screen
 Schermo opale
 Écran opale
 Opal-Bildschirm
 Pantalla opal

Note: the filter and the screen must be ordered together with the lighting fixture - **Nota:** il filtro e lo schermo devono essere ordinati congiuntamente all'apparecchio - **Note:** le filtre et l'écran doivent être commandées en même temps que l'appareil
Anmerkung: müssen der Filter und der Bildschirm zusammen mit Leuchtkörper bestellt werden
Nota: el filtro y la pantalla deben pedirse juntos con la luminaria

AL7022

24VDC/500mA constant current converter
 Convertitore 24VDC/500mA corrente costante
 Convertisseur 24VDC/500mA courant constant
 24VDC/500mA konstanter Strom konverter
 Convertidor 24VDC/500mA corriente constante

PLEXUS 10 UGR

design: Rod&Todd

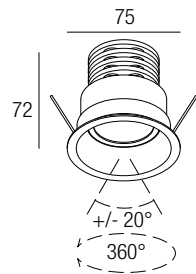

Supply current

Alimentazione
Courant d'alimentation
Stromversorgung
Corriente de alimentación
500 mA (V_i 18V)

Power

Potenza
Puissance
Bestuekung
Potencia
10 W

Series wiring

Cablaggio in serie
Câblage en série
Verkabelung in Serie
Cableado en serie



CCT/CRI/Flux

	CRI85	CRI93
2700K	890 lm	840 lm
3000K	1000 lm	930 lm
4000K	1040 lm	960 lm

Photometric diagrams

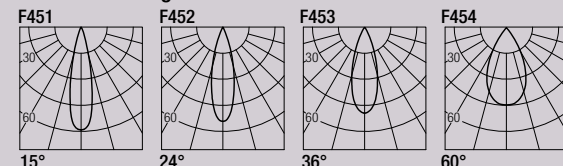

CRI85 - CRI93
2-Step MacAdam

Code Construction

Costruzione del codice - Construction du code produit
Bau der Produkt-Code - Construcción del código de producto

PLXU1 X X X X

Beam angle
Apertura di fascio
Angle de faisceau
Strahlwinkel
Ángulo del haz

N S M W
15° 24° 36° 60°

CRI
8 9
85 93

Color Temperature
Temperatura colore
Température couleur
Temperaturabhängige Farbe
Temperatura de color

2 3 4
2700K 3000K 4000K

Finishing
Finitura
Finitions
Oberflächenfinish
Acabados

1 5
White Black
Bianco Nero
Blanc Noir
Weiß Schwarz
Blanco Negro

Drivers

Alimentatori - Alimentateurs
Netzteile - Alimentadores

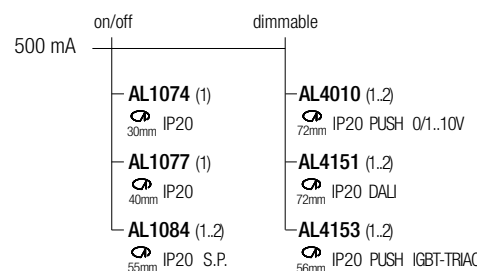

PLEXUS 724 UGR

design: Rod&Todd

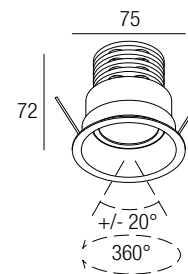

Supply current

Alimentazione
Courant d'alimentation
Stromversorgung
Corriente de alimentación
24 VDC

Power

Potenza
Puissance
Bestuekung
Potencia
7 W

Parallel wiring

Cablaggio in parallelo
Câblage en parallèle
Verkabelung in parallel
Cableado en paralelo



CCT/CRI/Flux

	CRI85	CRI93
2700K	630 lm	590 lm
3000K	700 lm	650 lm
4000K	730 lm	670 lm

Photometric diagrams

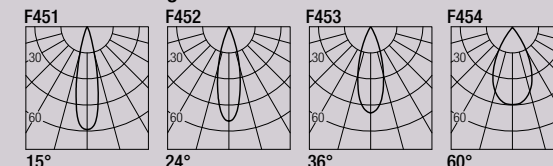

CRI85 - CRI93
2-Step MacAdam

Code Construction

Costruzione del codice - Construction du code produit
Bau der Produkt-Code - Construcción del código de producto

PLXU24 X X X X

Beam angle
Apertura di fascio
Angle de faisceau
Strahlwinkel
Ángulo del haz

N S M W
15° 24° 36° 60°

CRI
8 9
85 93

Color Temperature
Temperatura colore
Température couleur
Temperaturabhängige Farbe
Temperatura de color

2 3 4
2700K 3000K 4000K

Finishing
Finitura
Finitions
Oberflächenfinish
Acabados

1 5
White Black
Bianco Nero
Blanc Noir
Weiß Schwarz
Blanco Negro

Drivers

Alimentatori - Alimentateurs
Netzteile - Alimentadores

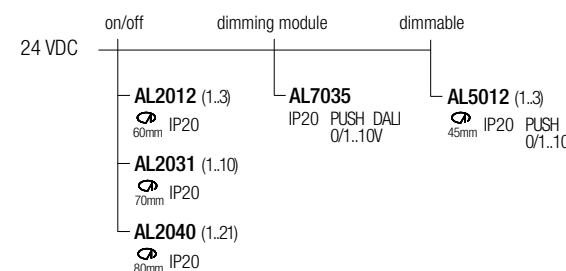

Note: dimming module AL7035 to be used in combination with an on/off 24VDC power supply
Nota: modulo di dimmerazione AL7035 da utilizzare in combinazione con un alimentatore on/off 24VDC
Note: module de variation AL7035 d'intensité à utiliser en combinaison avec une alimentation on/off 24VDC
Anmerkung: Dimmmodul AL7035 zur Verwendung in Kombination mit einem on/off 24VDC-Netzteil
Nota: módulo de regulación AL7035 se utiliza en combinación con una fuente de alimentación on/off 24VDC

Accessories

Accessori - Accessoires
Zubehör - Accesorios

LPLXU101

Low luminance louver
Filtro antiabbagliamento
Filtre basse luminance
Geringe Leuchtdichte-Filter
Filtro de baja luminancia

SPLXU101

Milky screen
Schermo opale
Écran opale
Opal-Bildschirm
Pantalla opal

Note: the filter and the screen must be ordered together with the lighting fixture - **Nota:** il filtro e lo schermo devono essere ordinati congiuntamente all'apparecchio - **Note:** le filtre et l'écran doivent être commandées en même temps que l'appareil
Anmerkung: müssen der Filter und der Bildschirm zusammen mit Leuchtkörper bestellt werden
Nota: el filtro y la pantalla deben pedirse juntos con la luminaria

AL7022

24VDC/500mA constant current converter
Convertitore 24VDC/500mA corrente costante
Convertisseur 24VDC/500mA courant constant
24VDC/500mA konstanter Strom konverter
Convertidor 24VDC/500mA corriente constante

Accessories

Accessori - Accessoires
Zubehör - Accesorios

LPLXU2401

Low luminance louver
Filtro antiabbagliamento
Filtre basse luminance
Geringe Leuchtdichte-Filter
Filtro de baja luminancia

SPLXU2401

Milky screen
Schermo opale
Écran opale
Opal-Bildschirm
Pantalla opal

Note: the filter and the screen must be ordered together with the lighting fixture - **Nota:** il filtro e lo schermo devono essere ordinati congiuntamente all'apparecchio - **Note:** le filtre et l'écran doivent être commandées en même temps que l'appareil
Anmerkung: müssen der Filter und der Bildschirm zusammen mit Leuchtkörper bestellt werden
Nota: el filtro y la pantalla deben pedirse juntos con la luminaria

GAGARIN PT2

design: Roberto Mantovani

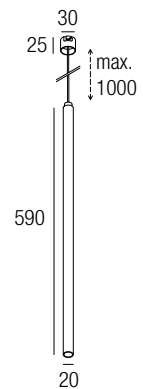

Supply current

Alimentazione
Courant d'alimentation
Stromversorgung
Corriente de alimentación
500 mA (V, 2,9V)

Power

Potenza
Puissance
Bestuekung
Potencia
2 W

Series wiring

Cablaggio in serie
Câblage en série
Verkabelung in Serie
Cableado en serie



CCT/CRI/Flux

2700K — 128 lm
3000K — 133 lm
4200K — 154 lm

Photometric diagrams

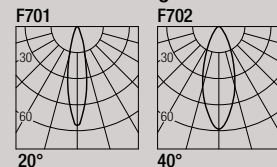

CRI85

2-Step MacAdam



GAGARIN PT6

design: Roberto Mantovani

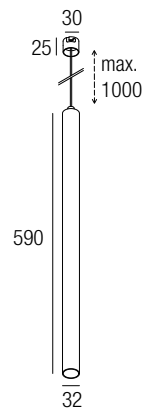

Supply current

Alimentazione
Courant d'alimentation
Stromversorgung
Corriente de alimentación
500 mA (V, 9V)

Power

Potenza
Puissance
Bestuekung
Potencia
6 W

Series wiring

Cablaggio in serie
Câblage en série
Verkabelung in Serie
Cableado en serie



CCT/CRI/Flux

2700K — 540 lm
3000K — 600 lm
4000K — 620 lm

Photometric diagrams

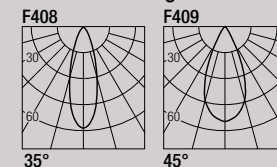

CRI98

2-Step MacAdam



Code Construction

Costruzione del codice - Construction du code produit
Bau der Produkt-Code - Construcción del código de producto

GPT2 X X X

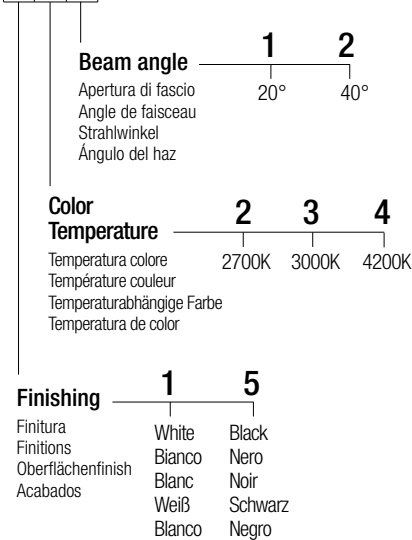

Accessories

Accessori - Accessoires
Zubehör - Accesorios

ZQC001 ZQC001B

White Bianco
Black Nero
Blanc Noir
Weiß Schwarz
Blanco Negro

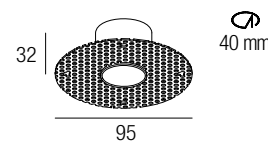

Plasterboard recessing frame
Flangia per cartongesso
Boîtier d'encastrement pour plaques de plâtre
Gehäuses Trockenbau
Cajetín para placas de yeso

Note: cable cut to measure on request
Nota: cavo a misura disponibile su richiesta
Note: câble sur mesure disponible sur demande
Anmerkung: kundenspezifisches Kabel auf Anfrage erhältlich
Nota: cable a medida disponible a petición

Drivers

Alimentatori - Alimentateurs
Netzteile - Alimentadores

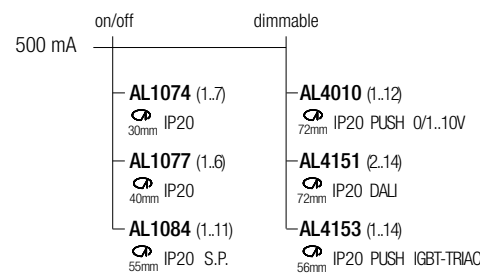

Code Construction

Costruzione del codice - Construction du code produit
Bau der Produkt-Code - Construcción del código de producto

GPT6 X X X

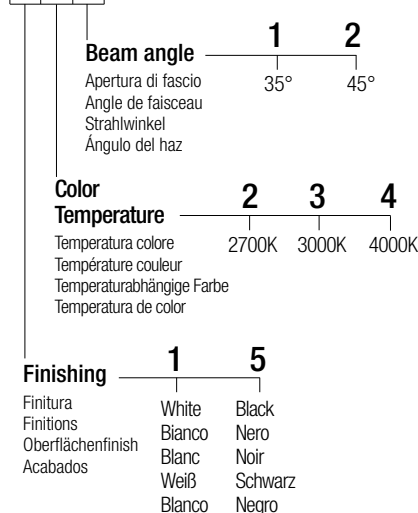

Accessories

Accessori - Accessoires
Zubehör - Accesorios

ZQC001 ZQC001B

White Bianco
Black Nero
Blanc Noir
Weiß Schwarz
Blanco Negro

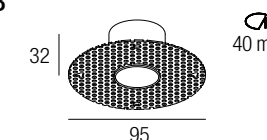

Plasterboard recessing frame
Flangia per cartongesso
Boîtier d'encastrement pour plaques de plâtre
Gehäuses Trockenbau
Cajetín para placas de yeso

LJ02 White Bianco
LJ02B Black Nero
SJ02 White Bianco
SJ02B Black Nero

Low luminance louver
Filtro antiabbagliamento
Filtre basse luminance
Geringe Leuchtdichte-Filter
Filtro de baja luminancia

Milky screen
Schermo opale
Écran opale
Opal-Bildschirm
Pantalla opal

Note: cable cut to measure on request
Nota: cavo a misura disponibile su richiesta
Note: câble sur mesure disponible sur demande
Anmerkung: kundenspezifisches Kabel auf Anfrage erhältlich
Nota: cable a medida disponible a petición

GAGARIN PT10

design: Roberto Mantovani

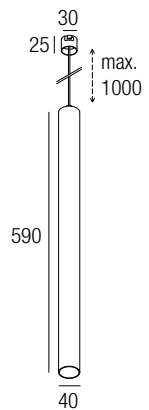

Supply current

Alimentazione
Courant d'alimentation
Stromversorgung
Corriente de alimentación

500 mA (V, 18V)

Power

Potenza
Puissance
Bestuekung
Potencia

10 W

Series wiring

Cablaggio in serie
Câblage en série
Verkabelung in Serie
Cableado en serie



CCT/CRI/Flux

	CRI85	CRI93
2700K	890 lm	840 lm
3000K	1000 lm	930 lm
4000K	1040 lm	960 lm

CRI85 - CRI93

2-Step MacAdam

Photometric diagrams

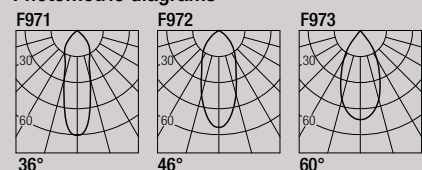

Code Construction

Costruzione del codice - Construction du code produit
Bau der Produkt-Code - Construcción del código de producto

GPT1 X X X X

Beam angle

Apertura di fascio
Angle de faisceau
Strahlwinkel
Ángulo del haz

S	M	W	X
36°	46°	60°	10-55°

Adjustable optics
Optica variabile
Optique réglable
Einstellbarer Optik
Óptica ajustable

CRI	8	9
	85	93

Color Temperature

2	3	4
2700K	3000K	4000K

Temperatura colore
Température couleur
Temperaturabhängige Farbe
Temperatura de color

Finishing

1	5
White Bianco Blanc Weiß Blanco	Black Nero Noir Schwarz Negro

Finitura
Finitions
Oberflächenfinish
Acabados

Accessories

Accessori - Accessoires
Zubehör - Accesorios

ZQC001 ZQC001B

White
Bianco
Blanc
Weiß
Blanco

Black
Nero
Noir
Schwarz
Negro

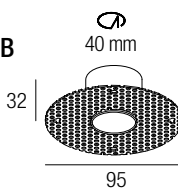

Plasterboard recessing frame
Flangia per cartongesso
Boîtier d'encastrement pour plaques de plâtre
Gehäuses Trockenbau
Cajetín para placas de yeso

LJ01 LJ01B

White
Bianco
Blanc
Weiß
Blanco

Black
Nero
Noir
Schwarz
Negro

Low luminance louver
Filtro antiabbagliamento
Filtre basse luminance
Geringe Leuchtdichte-Filter
Filtro de baja luminancia

SJ01 SJ01B

White
Bianco
Blanc
Weiß
Blanco

Black
Nero
Noir
Schwarz
Negro

Milky screen
Schermo opale
Écran opale
Opal-Bildschirm
Pantalla opal

Note: the filter and the screen are not available in 10-55° adjustable optics version - **Nota:** il filtro e lo schermo non sono disponibili nella versione ad ottica regolabile 10-55° - **Note:** le filtre et l'écran ne sont pas disponibles dans la version à optique réglable 10-55° - **Anmerkung:** Filter und Bildschirm sind in der einstellbaren optischen Version 10-55° nicht verfügbar - **Nota:** el filtro y la pantalla no están disponibles en la versión de óptica ajustable 10-55°

Drivers

Alimentatori - Alimentateurs
Netzteile - Alimentadores

500 mA	on/off	dimnable
AL1074 (1)	AL4010 (1.2)	
30mm IP20	72mm IP20 PUSH 0/1..10V	
AL1077 (1)	AL4151 (1.2)	
40mm IP20	72mm IP20 DALI	
AL1084 (1.2)	AL4153 (1.2)	
55mm IP20 S.P.	56mm IP20 PUSH IGBT-TRIAC	

Note: cable cut to measure on request
Nota: cavo a misura disponibile su richiesta
Note: câble sur mesure disponible sur demande
Anmerkung: kundenspezifisches Kabel auf Anfrage erhältlich
Nota: cable a medida disponible a petición



JOS PT2

design: Roberto Mantovani

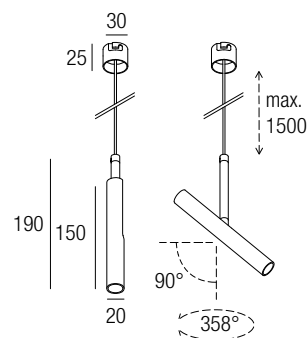

Supply current
Alimentazione
Courant d'alimentation
Stromversorgung
Corriente de alimentación
500 mA (V_i 2,9V)

Power
Potenza
Puissance
Bestuekung
Potencia
2 W

Series wiring
Cablaggio in serie
Câblage en série
Verkabelung in Serie
Cableado en serie



Photometric diagrams

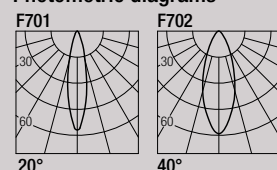

CCT/CRI/Flux

2700K	128 lm
3000K	133 lm
4200K	154 lm

CRI85
2-Step MacAdam



JOS PT6

design: Roberto Mantovani

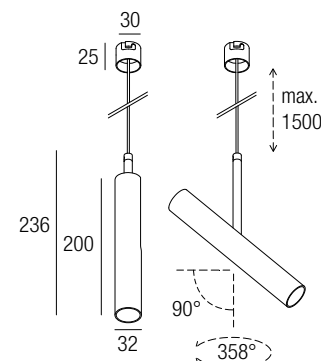

Supply current
Alimentazione
Courant d'alimentation
Stromversorgung
Corriente de alimentación
500 mA (V_i 9V)

Power
Potenza
Puissance
Bestuekung
Potencia
6 W

Series wiring
Cablaggio in serie
Câblage en série
Verkabelung in Serie
Cableado en serie



Photometric diagrams

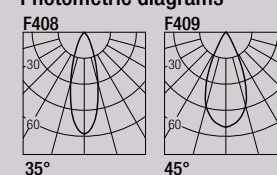

CCT/CRI/Flux

2700K	540 lm
3000K	600 lm
4000K	620 lm

CRI98
2-Step MacAdam



Code Construction

Costruzione del codice - Construction du code produit
Bau der Produkt-Code - Construcción del código de producto

JSPT2 X X X

Beam angle 1 2
Apertura di fascio 20° 40°
Angle de faisceau
Strahlwinkel
Ángulo del haz

Color Temperature 2 3 4
Temperatura colore 2700K 3000K 4200K
Température couleur
Temperaturabhängige Farbe
Temperatura de color

Finishing 1 5
Finitura White Black
Finitions Bianco Nero
Oberflächenfinish Blanc Noir
Acabados Weiß Schwarz
Blanco Negro

Accessories

Accessori - Accessoires
Zubehör - Accesorios

ZQC001 ZQC001B

White Black
Bianco Nero
Blanc Noir
Weiß Schwarz
Blanco Negro

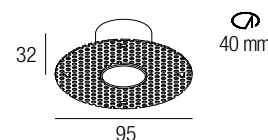

Plasterboard recessing frame
Flangia per cartongesso
Boîtier d'encastrement pour plaques de plâtre
Gehäuses Trockenbau
Cajetín para placas de yeso

Note: cable cut to measure on request
Nota: cavo a misura disponibile su richiesta
Note: câble sur mesure disponible sur demande
Anmerkung: kundenspezifisches Kabel auf Anfrage erhältlich
Nota: cable a medida disponible a petición

Drivers

Alimentatori - Alimentateurs
Netzteile - Alimentadores

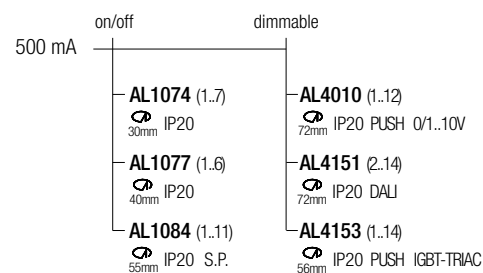

Code Construction

Costruzione del codice - Construction du code produit
Bau der Produkt-Code - Construcción del código de producto

JSPT6 X X X

Beam angle 1 2
Apertura di fascio 35° 45°
Angle de faisceau
Strahlwinkel
Ángulo del haz

Color Temperature 2 3 4
Temperatura colore 2700K 3000K 4000K
Température couleur
Temperaturabhängige Farbe
Temperatura de color

Finishing 1 5
Finitura White Black
Finitions Bianco Nero
Oberflächenfinish Blanc Noir
Acabados Weiß Schwarz
Blanco Negro

Drivers

Alimentatori - Alimentateurs
Netzteile - Alimentadores

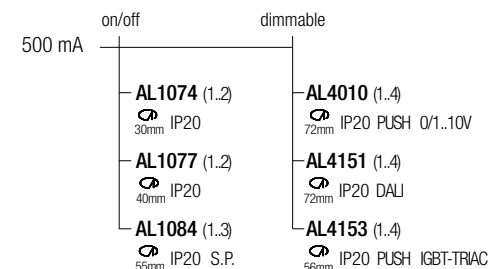

Accessories

Accessori - Accessoires
Zubehör - Accesorios

ZQC001 ZQC001B

White Black
Bianco Nero
Blanc Noir
Weiß Schwarz
Blanco Negro

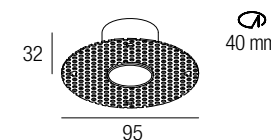

Plasterboard recessing frame
Flangia per cartongesso
Boîtier d'encastrement pour plaques de plâtre
Gehäuses Trockenbau
Cajetín para placas de yeso

LJ02	White	LJ02B	Black	SJ02	White	SJ02B	Black
	Bianco		Nero		Bianco		Nero
	Blanc		Noir		Blanc		Noir
	Weiß		Schwarz		Weiß		Schwarz
	Blanco		Negro		Blanco		Negro

Low luminance louver
Filtro antiabagliamento
Filtre basse luminance
Geringe Leuchtdichte-Filter
Filtro de baja luminancia

Milky screen
Schermo opale
Ecran opale
Opal-Bildschirm
Pantalla opal

Note: cable cut to measure on request
Nota: cavo a misura disponibile su richiesta
Note: câble sur mesure disponible sur demande
Anmerkung: kundenspezifisches Kabel auf Anfrage erhältlich
Nota: cable a medida disponible a petición

JOS PT10

design: Roberto Mantovani

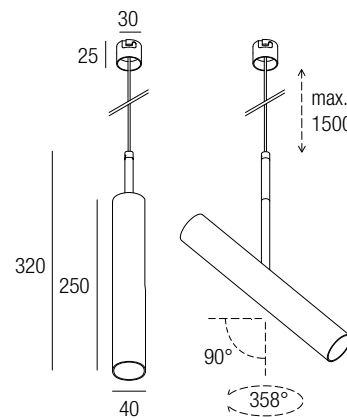

Supply current

Alimentazione
 Courant d'alimentation
 Stromversorgung
 Corriente de alimentación
500 mA (V_I 18V)

Power

Potenza
 Pouissance
 Câblage en série
 Verkabelung in Serie
 Cableado en serie
10 W

Series wiring

Cablaggio in serie
 Câblage en série
 Verkabelung in Serie
 Cableado en serie



Photometric diagrams

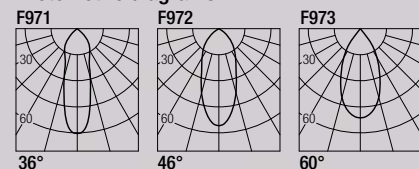

CCT/CRI/Flux

	CRI85	CRI93
2700K	890 lm	840 lm
3000K	1000 lm	930 lm
4000K	1040 lm	960 lm

CRI85 - CRI93
2-Step MacAdam



Code Construction

Costruzione del codice - Construction du code produit
 Bau der Produkt-Code - Construcción del código de producto

JSPT1 X X X X

Beam angle	S	M	W	X
Apertura di fascio Angle de faisceau Strahlwinkel Angulo del haz	36°	46°	60°	10-55°
Adjustable optics Optica variabile Optique réglable Einstellbarer Optik Óptica ajustable				

CRI	8	9
	85	93

Color Temperature	2	3	4
Temperatura colore Température couleur Temperaturabhängige Farbe Temperatura de color	2700K	3000K	4000K

Finishing	1	5
Finitura Finitions Oberflächenfinish Acabados	White Bianco Blanc Weiß Blanco	Black Nero Noir Schwarz Negro

Note: cable cut to measure on request
Nota: cavo a misura disponibile su richiesta
Note: câble sur mesure disponible sur demande
Anmerkung: kundenspezifisches Kabel auf Anfrage erhältlich
Nota: cable a medida disponible a petición

Accessories

Accessori - Accessoires
 Zubehör - Accesorios

ZQC001	ZQC001B
White Bianco Blanc Weiß Blanco	Black Nero Noir Schwarz Negro

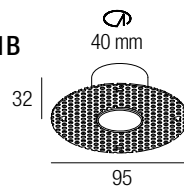

Plasterboard recessing frame
 Flangia per cartongesso
 Boîtier d'encastrement pour plaques de plâtre
 Gehäuses Trockenbau
 Cajetín para placas de yeso

LJ01	LJ01B
White Bianco Blanc Weiß Blanco	Black Nero Noir Schwarz Negro

Low luminance louver
 Filtro antiabbagliamento
 Filtre basse luminance
 Geringe Leuchtdichte-Filter
 Filtro de baja luminancia

SJ01	SJ01B
White Bianco Blanc Weiß Blanco	Black Nero Noir Schwarz Negro

Milky screen
 Schermo opale
 Écran opale
 Opal-Bildschirm
 Pantalla opal

Note: the filter and the screen are not available in 10-55° adjustable optics version - **Nota:** il filtro e lo schermo non sono disponibili nella versione ad ottica regolabile 10-55° - **Note:** le filtre et l'écran ne sont pas disponibles dans la version à optique réglable 10-55°
Anmerkung: Filter und Bildschirm sind in der einstellbaren optischen Version 10-55° nicht verfügbar - **Nota:** el filtro y la pantalla no están disponibles en la versión de óptica ajustable 10-55°

Drivers

Alimentatori - Alimentateurs
 Netzteile - Alimentadores

500 mA	on/off	dimmable
AL1074 (1) 30mm IP20	AL4010 (1,2) 72mm IP20 PUSH 0/1..10V	
AL1077 (1) 40mm IP20	AL4151 (1,2) 72mm IP20 DALI	
AL1084 (1,2) 55mm IP20 S.P.	AL4153 (1,2) 56mm IP20 PUSH IGBT-TRIAC	



24VDC TRACK



24VDC track system for surface installation.

Sistema di binario 24VDC per installazione superficiale.

Système de voie 24VDC pour installation en surface.

24VDC Schienensystem für Anbaumontage.

Sistema de carril 24VDC para instalación en superficie.

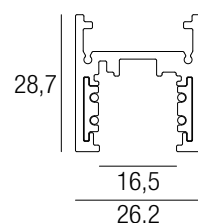

Code Construction

Costruzione del codice - Construction du code produit
Bau der Produkt-Code - Construcción del código de producto

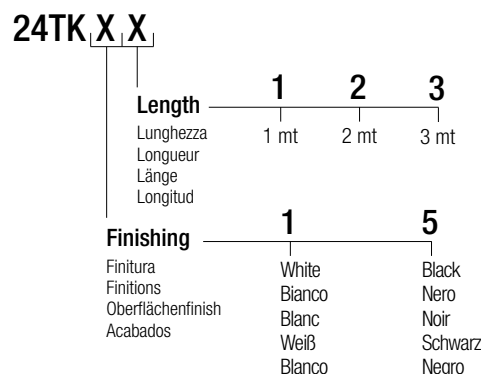

Load schemes - Schemi di carico

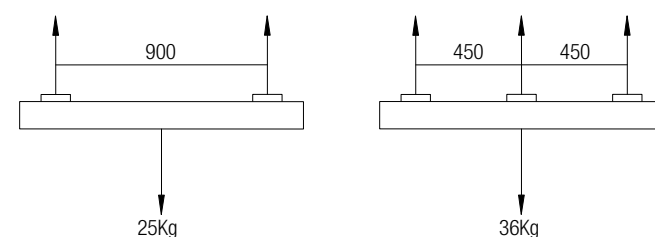

Drivers

Alimentatori - Alimentateurs
Netzteile - Alimentadores

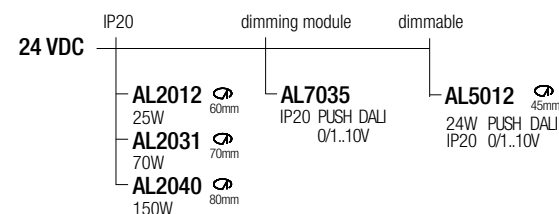

Note: dimming module AL7035 to be used in combination with a 24VDC power supply - **Nota:** modulo di dimmerazione AL7035 da utilizzare in combinazione con un alimentatore 24VDC - **Note:** module de variation AL7035 d'intensité à utiliser en combinaison avec une alimentation 24VDC - **Anmerkung:** Dimmmodul AL7035 zur Verwendung in Kombination mit einem 24VDC-Netzteil - **Nota:** módulo de regulación AL7035 se utiliza en combinación con una fuente de alimentación 24VDC

Accessories - Accessori

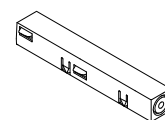

Alimentazione
Live-end
Alimentation
Macht
Alimentación

24TK011 Bianco - White - Blanc
Weiß - Blanco

24TK015 Nero - Black - Noir
Schwarz - Negro

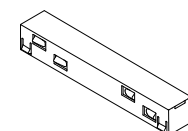

Giunto lineare con contatti
Electrical straight joint
Joint électrique
Elektrische Verbindung
Junta electrica

24TK021 Bianco - White - Blanc
Weiß - Blanco

24TK025 Nero - Black - Noir
Schwarz - Negro

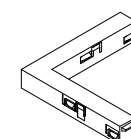

Giunto L elettrico
Electrical L joint
Joint L électrique
Elektrisches L-Verbindung
Junta L eléctrica

24TK031 Bianco - White - Blanc
Weiß - Blanco

24TK035 Nero - Black - Noir
Schwarz - Negro

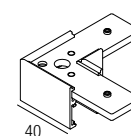

Giunto L meccanico
Mechanical L joint
Joint L mécanique
Mechanische L-Verbindung
Junta L mecánica

24TK041 Bianco - White - Blanc
Weiß - Blanco

24TK045 Nero - Black - Noir
Schwarz - Negro



Tappo di chiusura
Dead end
Bouchon
Endkappe
Tapa final

24TK051 Bianco - White - Blanc
Weiß - Blanco

24TK055 Nero - Black - Noir
Schwarz - Negro

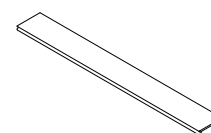

Copertura binario 3000mm
Track cover 3000mm
Écran 3000mm
Schirm 3000mm
Pantalla 3000mm

24TK061 Bianco - White - Blanc
Weiß - Blanco

24TK065 Nero - Black - Noir
Schwarz - Negro

24VDC TRIMLESS TRACK



24VDC track system for trimless recessed installation.

Sistema di binario 24VDC per installazione a incasso trimless.

Système de voie 24VDC pour une installation encastrée sans bordure.

24VDC Schienensystem für randlosen Einbau.

Sistema de carril 24VDC para instalación empotrada trimless.

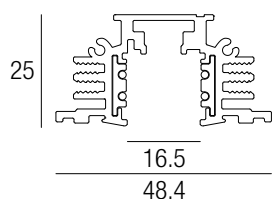

Code Construction

Costruzione del codice - Construction du code produit
Bau der Produkt-Code - Construcción del código de producto

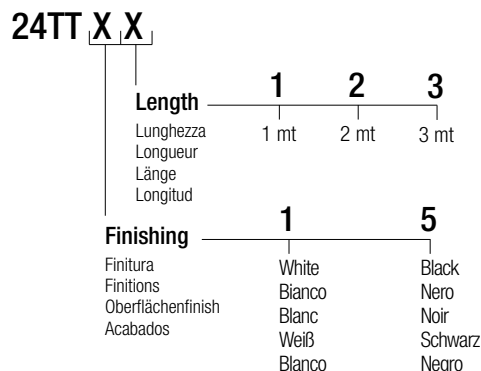

Load schemes - Schemi di carico

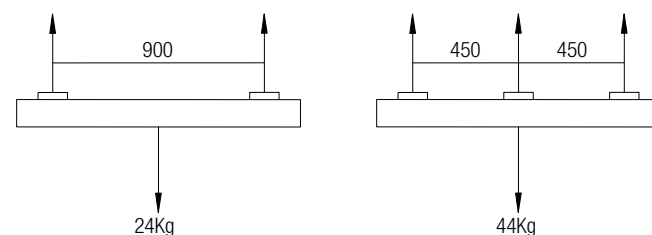

Drivers

Alimentatori - Alimentateurs
Netzteile - Alimentadores

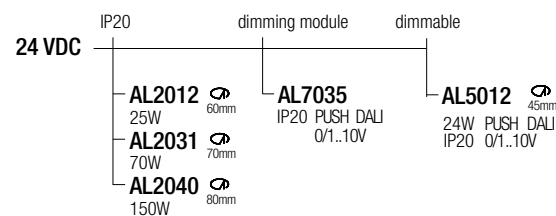

Note: dimming module AL7035 to be used in combination with a 24VDC power supply - **Nota:** modulo di dimmerazione AL7035 da utilizzare in combinazione con un alimentatore 24VDC - **Note:** module de variation AL7035 d'intensité à utiliser en combinaison avec une alimentation 24VDC - **Anmerkung:** Dimmmodul AL7035 zur Verwendung in Kombination mit einem 24VDC-Netzteil - **Nota:** módulo de regulación AL7035 se utiliza en combinación con una fuente de alimentación 24VDC

Accessories - Accessori

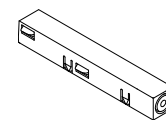

Alimentazione
Live-end
Alimentation
Macht
Alimentación

24TT011 Bianco - White - Blanc
Weiß - Blanco

24TT015 Nero - Black - Noir
Schwarz - Negro

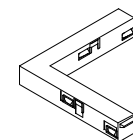

Giunto L elettrico
Electrical L joint
Joint L électrique
Elektrisches L-Verbindung
Junta L eléctrica

24TT031 Bianco - White - Blanc
Weiß - Blanco

24TT035 Nero - Black - Noir
Schwarz - Negro



Tappo di chiusura
Dead end
Bouchon
Endkappe
Tapa final

24TT051 Bianco - White - Blanc
Weiß - Blanco

24TT055 Nero - Black - Noir
Schwarz - Negro

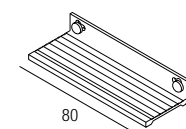

Staffa per installazione trimless
Bracket for trimless installation
Support pour installation sans bordure
Halterung für randlose Installation
Soporte para instalación sin marco

24TT07

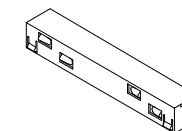

Giunto lineare con contatti
Electrical straight joint
Joint électrique
Elektrische Verbindung
Junta electrica

24TT021 Bianco - White - Blanc
Weiß - Blanco

24TT025 Nero - Black - Noir
Schwarz - Negro

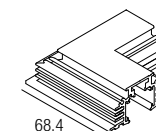

Giunto L meccanico
Mechanical L joint
Joint L mécanique
Mechanische L-Verbindung
Junta L mecánica

24TT041 Bianco - White - Blanc
Weiß - Blanco

24TT045 Nero - Black - Noir
Schwarz - Negro

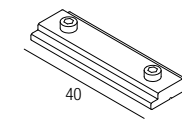

Staffa di rinforzo per giunzione lineare
Reinforcing bracket for linear junction
Support de renfort pour jonction linéaire
Verstärkungsbügel für linearen Anschluss
Soporte de refuerzo para unión lineal

24TT061 Bianco - White - Blanc
Weiß - Blanco

24TT065 Nero - Black - Noir
Schwarz - Negro

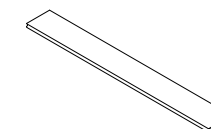

Copertura binario 3000mm
Track cover 3000mm
Écran 3000mm
Schirm 3000mm
Pantalla 3000mm

24TT081 Bianco - White - Blanc
Weiß - Blanco

24TT085 Nero - Black - Noir
Schwarz - Negro

MINIJOS T2

design: Roberto Mantovani

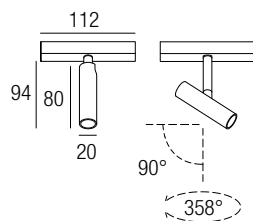

Supply current

Alimentazione
Courant d'alimentation
Stromversorgung
Corriente de alimentación

24 VDC

Power

Potenza
Puissance
Bestuekung
Potencia

2 W



CCT/CRI/Flux

Photometric diagrams

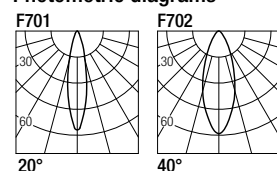

2700K — 128 lm
3000K — 133 lm
4200K — 154 lm

CRI85

2-Step MacAdam

Code Construction

Costruzione del codice - Construction du code produit
Bau der Produkt-Code - Construcción del código de producto

MJST2 X X X

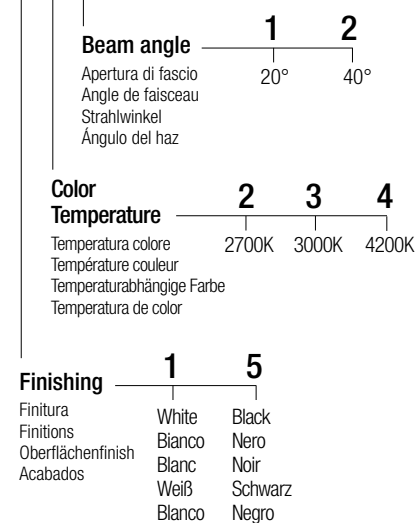

Note: versions with extended arm length are available upon request
Nota: versioni con lunghezza del braccetto maggiorata disponibili su richiesta
Note: versions avec longueur du bras majorée disponibles sur demande
Anmerkung: versionen mit erhöhter Armlänge auf Anfrage erhältlich
Nota: Versiones con longitud del brazo aumentada disponible bajo pedido

MINIJOS T6

design: Roberto Mantovani

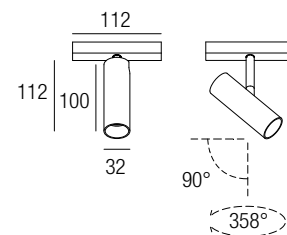

Supply current

Alimentazione
Courant d'alimentation
Stromversorgung
Corriente de alimentación

24 VDC

Power

Potenza
Puissance
Bestuekung
Potencia

6 W



CCT/CRI/Flux

Photometric diagrams

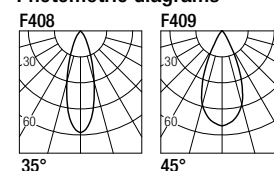

2700K — 540 lm
3000K — 600 lm
4000K — 620 lm

CRI98

2-Step MacAdam

Code Construction

Costruzione del codice - Construction du code produit
Bau der Produkt-Code - Construcción del código de producto

MJST6 X X X

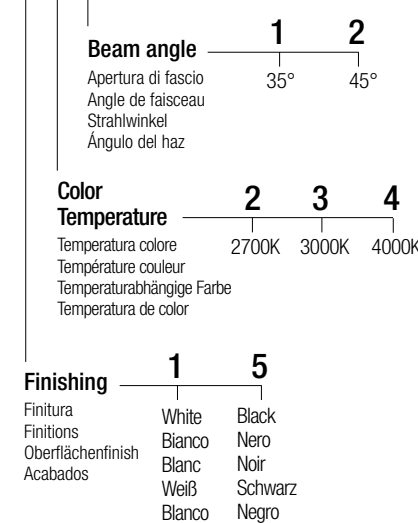

Note: versions with extended arm length are available upon request
Nota: versioni con lunghezza del braccetto maggiorata disponibili su richiesta
Note: versions avec longueur du bras majorée disponibles sur demande
Anmerkung: versionen mit erhöhter Armlänge auf Anfrage erhältlich
Nota: Versiones con longitud del brazo aumentada disponible bajo pedido

Accessories

Accessori - Accessoires
Zubehör - Accesorios

LJ02 White Bianco Blanc Weiß Blanco	LJ02B Black Nero Noir Schwarz Negro	SJ02 White Bianco Blanc Weiß Blanco	SJ02B Black Nero Noir Schwarz Negro
Low luminance louver Filtro antiabbagliamento Filtre basse luminance Geringe Leuchtdichte-Filter Filtro de baja luminancia		Milky screen Schermo opale Écran opale Opal-Bildschirm Pantalla opal	

MINIJOS T10

design: Roberto Mantovani

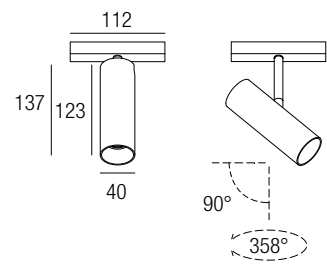

Supply current
Alimentazione
Courant d'alimentation
Stromversorgung
Corriente de alimentación
24 VDC

Power
Potenza
Puissance
Bestuekung
Potencia
10 W



Photometric diagrams

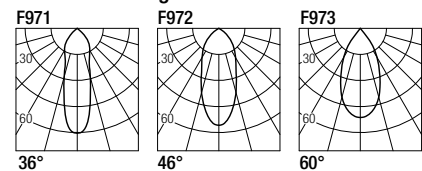

CCT/CRI/Flux	CRI85	CRI93
2700K	890 lm	840 lm
3000K	1000 lm	930 lm
4000K	1040 lm	960 lm

CRI85 - CRI93
2-Step MacAdam

Code Construction

Costruzione del codice - Construction du code produit
Bau der Produkt-Code - Construcción del código de producto

MJST1 X X X X

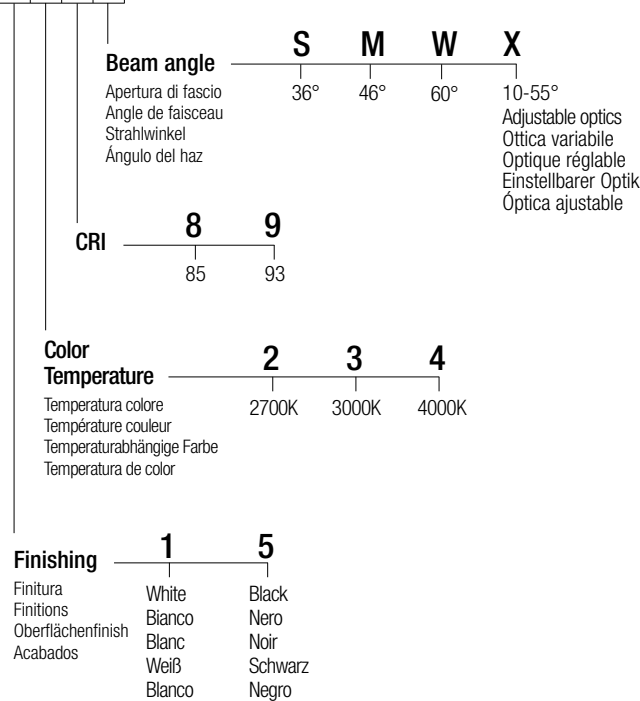

Note: versions with extended arm length are available upon request
Nota: versioni con lunghezza del braccetto maggiorata disponibili su richiesta
Note: versions avec longueur du bras majorée disponibles sur demande
Anmerkung: versionen mit erhöhter Armlänge auf Anfrage erhältlich
Nota: Versiones con longitud del brazo aumentada disponible bajo pedido

DATASHEET ▶ INSTALLATION MANUAL ▶

CERTIFICATIONS ▶ LDT-IES ▶ DRAWINGS ▶



LAD T6

design: Roberto Mantovani

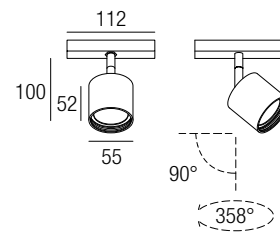

Supply current
Alimentazione
Courant d'alimentation
Stromversorgung
Corriente de alimentación
24 VDC

Power
Potenza
Puissance
Bestuekung
Potencia
6 W



Photometric diagrams

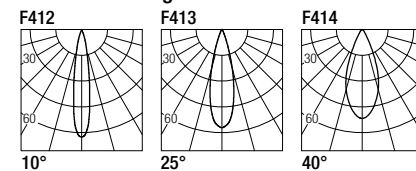

CCT/CRI/Flux	CRI85	CRI93
2700K	540 lm	
3000K	600 lm	
4000K	620 lm	

CRI98
2-Step MacAdam

Code Construction

Costruzione del codice - Construction du code produit
Bau der Produkt-Code - Construcción del código de producto

LADT6 X X X

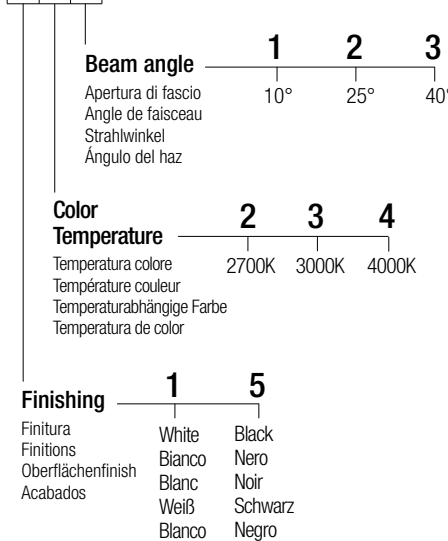

Note: versions with extended arm length are available upon request
Nota: versioni con lunghezza del braccetto maggiorata disponibili su richiesta
Note: versions avec longueur du bras majorée disponibles sur demande
Anmerkung: versionen mit erhöhter Armlänge auf Anfrage erhältlich
Nota: Versiones con longitud del brazo aumentada disponible bajo pedido

DATASHEET ▶ INSTALLATION MANUAL ▶

CERTIFICATIONS ▶ LDT-IES ▶ DRAWINGS ▶



Accessories

Accessori - Accessoires
Zubehör - Accesorios

LJ01	LJ01B	SJ01	SJ01B
White Bianco Blanc Weiß Blanco	Black Nero Noir Schwarz Negro	White Bianco Blanc Weiß Blanco	Black Nero Noir Schwarz Negro
Low luminance louver Filtro antiabbagliamento Filtre basse luminance Geringe Leuchtdichte-Filter Filtro de baja luminancia	Milky screen Schermo opale Écran opale Opal-Bildschirm Pantalla opal		

Note: the filter and the screen are not available in adjustable optics version 10-55° - **Nota:** il filtro e lo schermo non sono disponibili nella versione ad ottica regolabile 10-55° - **Note:** le filtre et l'écran ne sont pas disponibles dans la version à optique réglable 10-55° - **Anmerkung:** Filter und Bildschirm sind in der einstellbaren optischen Version 10-55° nicht verfügbar - **Nota:** el filtro y la pantalla no están disponibles en la versión de óptica ajustable 10-55°

Accessories

Accessori - Accessoires
Zubehör - Accesorios

LL02	LL02B	SL02	SL02B
White Bianco Blanc Weiß Blanco	Black Nero Noir Schwarz Negro	White Bianco Blanc Weiß Blanco	Black Nero Noir Schwarz Negro
Low luminance louver Filtro antiabbagliamento Filtre basse luminance Geringe Leuchtdichte-Filter Filtro de baja luminancia	Milky screen Schermo opale Écran opale Opal-Bildschirm Pantalla opal		

LAD T10

design: Roberto Mantovani

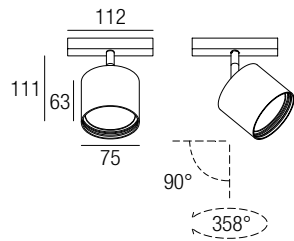

Supply current

Alimentazione
Courant d'alimentation
Stromversorgung
Corriente de alimentación

24 VDC

Power

Potenza
Puissance
Bestuekung
Potencia

10 W



Photometric diagrams

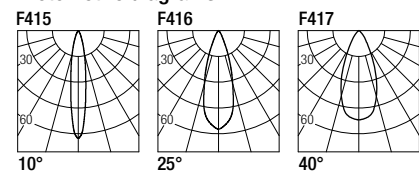

CCT/CRI/Flux

	CRI85	CRI93
2700K	890 lm	840 lm
3000K	1000 lm	930 lm
4000K	1040 lm	960 lm

CRI85 - CRI93

2-Step MacAdam

Code Construction

Costruzione del codice - Construction du code produit
Bau der Produkt-Code - Construcción del código de producto

LADT1 X X X X

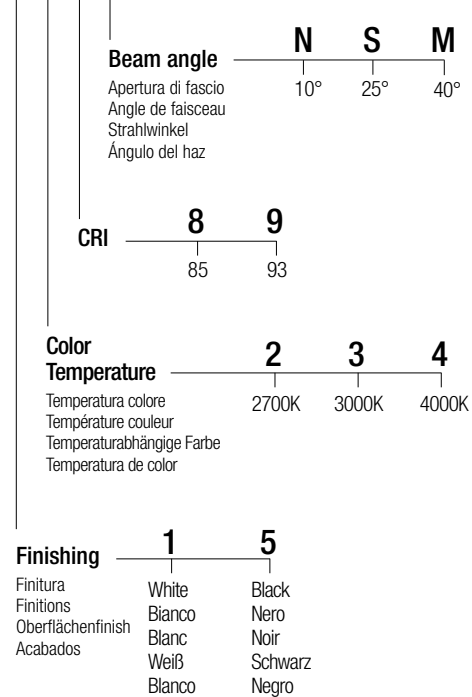

Note: versions with extended arm length are available upon request
Nota: versioni con lunghezza del braccetto maggiorata disponibili su richiesta
Note: versions avec longueur du bras majorée disponibles sur demande
Anmerkung: versionen mit erhöhter Armlänge auf Anfrage erhältlich
Nota: Versiones con longitud del brazo aumentada disponible bajo pedido

[DATASHEET](#) [INSTALLATION MANUAL](#)

[CERTIFICATIONS](#) [LDT-IES](#) [DRAWINGS](#)



LAD T10 WALL WASHER

design: Roberto Mantovani

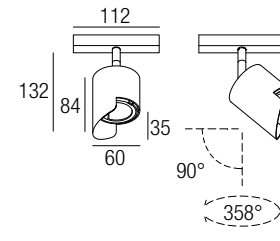

Supply current

Alimentazione
Courant d'alimentation
Stromversorgung
Corriente de alimentación

24 VDC

Power

Potenza
Puissance
Bestuekung
Potencia

10 W



Photometric diagrams

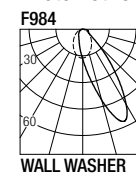

CCT/CRI/Flux

	CRI85	CRI93
2700K	890 lm	840 lm
3000K	1000 lm	930 lm
4000K	1040 lm	960 lm

CRI85 - CRI93

2-Step MacAdam

Code Construction

Costruzione del codice - Construction du code produit
Bau der Produkt-Code - Construcción del código de producto

LADTW X X X

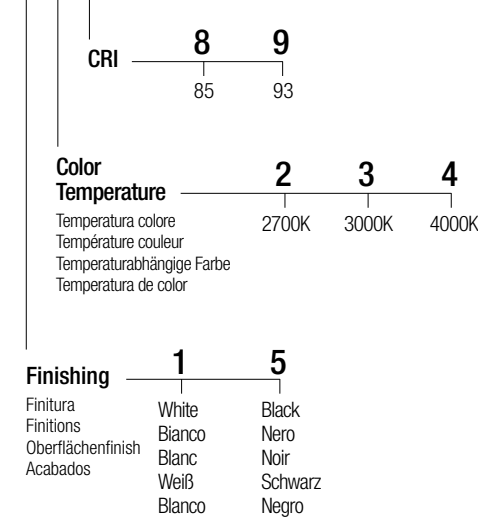

Note: versions with extended arm length are available upon request
Nota: versioni con lunghezza del braccetto maggiorata disponibili su richiesta
Note: versions avec longueur du bras majorée disponibles sur demande
Anmerkung: versionen mit erhöhter Armlänge auf Anfrage erhältlich
Nota: Versiones con longitud del brazo aumentada disponible bajo pedido

[DATASHEET](#) [INSTALLATION MANUAL](#)

[CERTIFICATIONS](#) [LDT-IES](#) [DRAWINGS](#)



FLY 6

design: Rod&Todd

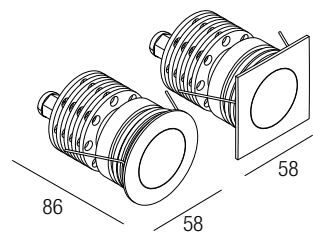

Supply current

Alimentazione
 Courant d'alimentation
 Stromversorgung
 Corriente de alimentación
500 mA (V, 9V)

Power

Potenza
 Pouissance
 Bestuekung
 Potencia
6 W

Series wiring

Cablaggio in serie
 Câblage en série
 Verkabelung in Serie
 Cableado en serie



Photometric diagrams

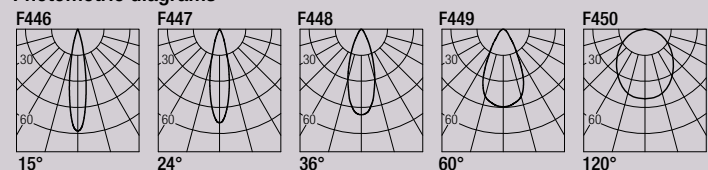

CCT/CRI/Flux

2700K — 540 lm
 3000K — 600 lm
 4000K — 620 lm

CRI98

2-Step MacAdam

Code Construction

Costruzione del codice - Construction du code produit
 Bau der Produkt-Code - Construcción del código de producto

FLY6 X X X X

Beam angle	N	S	M	W	X
Apertura di fascio Angle de faisceau Strahlwinkel Ángulo del haz	15°	24°	36°	60°	120°
Finishing	B	G	N	K	Z
Finitura Finitions Oberflächenfinish Acabados	White Bianco Weiß Blanco	Grey Grigio Gris Grau	Black Nero Schwarz Negro	COR-TEN	INOX AISI 316L Steel Acciaio Acier Stahl Acero
Color Temperature	2	3	4		
Temperatura colore Température couleur Temperaturabhängige Farbe Temperatura de color	2700K	3000K	4000K		
Shape	1	2			
Forma Forme Form	Round Tondo Ronde Runde Redondo	Square Quadro Carré Quadrat Cuadrado			

Accessories

Accessori - Accessoires
 Zubehör - Accesorios

CSDS10

Recessing box
 Controcassa
 Boîtier d'encastrement
 Eingießgehäuse
 Caja de empotrar

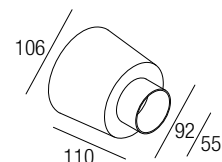

LFLY601

Low luminance louver
 Filtro antiabbagliamento
 Filtre basse luminance
 Geringe Leuchtdichte-Filter
 Filtro de baja luminancia



Note: the filter must be ordered together with the lighting fixture - **Nota:** il filtro deve essere ordinato congiuntamente all'apparecchio - **Note:** le filtre doit être commandé en même temps que l'appareil - **Anmerkung:** muss der Filter zusammen mit Leuchtkörper bestellt werden
Nota: el filtro debe pedirse junto con la luminaria

Drivers

Alimentatori - Alimentateurs
 Netzteile - Alimentadores

on/off	dimnable
500 mA	
AL1074 (1..2) 30mm IP20	AL4010 (1..4) 72mm IP20 PUSH 0/1..10V
AL1077 (1..2) 40mm IP20	AL4151 (1..4) 72mm IP20 DALI
AL1084 (1..3) 55mm IP20 S.P.	AL4153 (1..4) 56mm IP20 PUSH IGBT-TRIAC
AL9051 (1..3) 44mm IP67	AL8050 (2..4) IP67 DALI



FLY 10

design: Rod&Todd

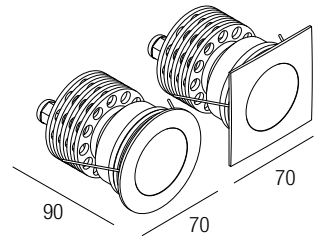

Supply current

Alimentazione
Courant d'alimentation
Stromversorgung
Corriente de alimentación

500 mA (V_i 18V)

Power

Potenza
Puissance
Bestuekung
Potencia

10 W

Series wiring

Cablaggio in serie
Câblage en série
Verkabelung in Serie
Cableado en serie

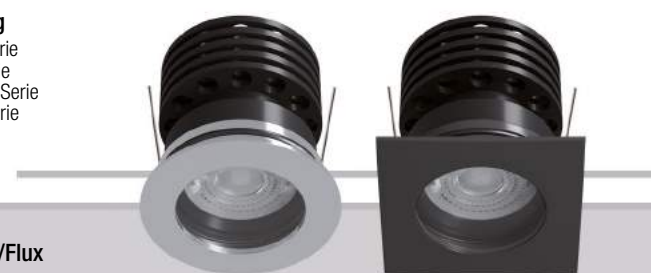

Photometric diagrams

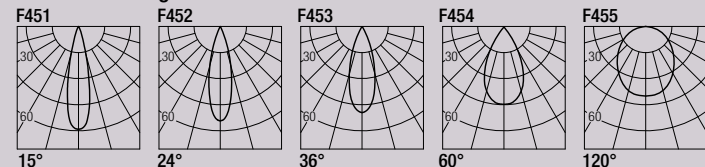

CCT/CRI/Flux

	CRI85	CRI93
2700K	890 lm	840 lm
3000K	1000 lm	930 lm
4000K	1040 lm	960 lm

CRI85 - CRI93

2-Step MacAdam

Code Construction

Costruzione del codice - Construction du code produit
Bau der Produkt-Code - Construcción del código de producto

FLY1 X X X X X

Beam angle

	N	S	M	W	X
Apertura di fascio Angle de faisceau Strahlwinkel Ángulo del haz	15°	24°	36°	60°	120°

Finishing

	B	G	N	K	Z
Finitura Finitions Oberflächenfinish Acabados	White Blanco Blanc Weiß Blanco	Grey Grigio Gris Grau	Black Nero Noir Schwarz Negro	COR-TEN	INOX AISI 316L Steel Acciaio Stahl Acero

CRI

8	9
85	93

Color Temperature

2	3	4
2700K	3000K	4000K
Temperatura colore Température couleur Temperaturabhängige Farbe Temperatura de color		

Shape

	1	2
Forma Forme Form	Round Tondo Ronde Runde Redondo	Square Quadro Carré Quadrat Cuadrado

Accessories

Accessori - Accessoires
Zubehör - Accesorios

CSXJ01

Recessing box
Controcassa
Boîtier d'encastrement
Eingießgehäuse
Caja de empotrar

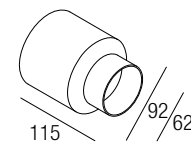

LFLY101

Low luminance louver
Filtro antiabbagliamento
Filtre basse luminance
Geringe Leuchtdichte-Filter
Filtro de baja luminancia



Note: the filter must be ordered together with the lighting fixture - **Nota:** il filtro deve essere ordinato congiuntamente all'apparecchio - **Note:** le filtre doit être commandé en même temps que l'appareil - **Anmerkung:** muss der Filter zusammen mit Leuchtkörper bestellt werden
Nota: el filtro debe pedirse junto con la luminaria

Drivers

Alimentatori - Alimentateurs
Netzteile - Alimentadores

500 mA	on/off	dimming
AL1074 (1)	AL4010 (1.2)	
30mm IP20	72mm IP20 PUSH 0/1..10V	
AL1077 (1)	AL4151 (1.2)	
40mm IP20	72mm IP20 DALI	
AL1084 (1.2)	AL4153 (1.2)	
55mm IP20 S.P.	56mm IP20 PUSH IGBT-TRIAC	
AL9051 (1.2)	AL8050 (1.2)	
44mm IP67	IP67 DALI	

FLY 724

design: Rod&Todd

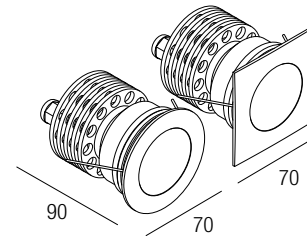

Supply current

Alimentazione
Courant d'alimentation
Stromversorgung
Corriente de alimentación

24 VDC

Power

Potenza
Puissance
Bestuekung
Potencia

7 W

Parallel wiring

Cablaggio in parallelo
Câblage en parallèle
Verkabelung in parallel
Cableado en paralelo

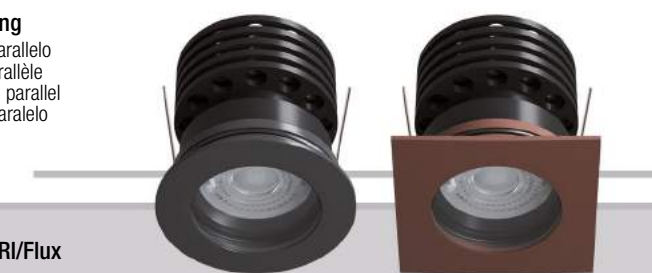

Photometric diagrams

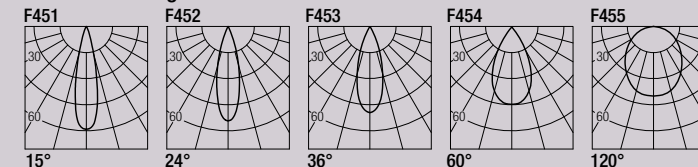

CCT/CRI/Flux

	CRI85	CRI93
2700K	630 lm	590 lm
3000K	700 lm	650 lm
4000K	730 lm	670 lm

CRI85 - CRI93

2-Step MacAdam

Code Construction

Costruzione del codice - Construction du code produit
Bau der Produkt-Code - Construcción del código de producto

FLY24 X X X X X

Beam angle

	N	S	M	W	X
Apertura di fascio Angle de faisceau Strahlwinkel Ángulo del haz	15°	24°	36°	60°	120°

Finishing

	B	G	N	K	Z
Finitura Finitions Oberflächenfinish Acabados	White Blanco Blanc Weiß Blanco	Grey Grigio Gris Grau	Black Nero Noir Schwarz Negro	COR-TEN	INOX AISI 316L Steel Acciaio Stahl Acero

CRI

8	9
85	93

Color Temperature

2	3	4
2700K	3000K	4000K
Temperatura colore Température couleur Temperaturabhängige Farbe Temperatura de color		

Shape

	1	2
Forma Forme Form	Round Tondo Ronde Runde Redondo	Square Quadro Carré Quadrat Cuadrado

Accessories

Accessori - Accessoires
Zubehör - Accesorios

CSXJ01

Recessing box
Controcassa
Boîtier d'encastrement
Eingießgehäuse
Caja de empotrar

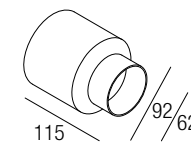

LFLY2401

Low luminance louver
Filtro antiabbagliamento
Filtre basse luminance
Geringe Leuchtdichte-Filter
Filtro de baja luminancia



Note: the filter must be ordered together with the lighting fixture - **Nota:** il filtro deve essere ordinato congiuntamente all'apparecchio - **Note:** le filtre doit être commandé en même temps que l'appareil - **Anmerkung:** muss der Filter zusammen mit Leuchtkörper bestellt werden
Nota: el filtro debe pedirse junto con la luminaria

Drivers

Alimentatori - Alimentateurs
Netzteile - Alimentadores

24 VDC	on/off	dimming module	dimming
AL2012 (1..3)	AL7035	AL5012 (1..3)	
60mm IP20	IP20 PUSH DALI 0/1..10V	45mm IP20 PUSH DALI 0/1..10V	
AL2031 (1..10)		AL8012 (1..3)	
70mm IP20		IP67 DALI	
AL2040 (1..21)			
80mm IP20			
AL9212 (1..2)			
110mm IP67			
AL9231 (1..10)			
85mm IP67			
AL9240 (1..21)			
85mm IP67			

Note: dimming module AL7035 to be used in combination with an on/off 24VDC power supply
Nota: modulo di dimmerazione AL7035 da utilizzare in combinazione con un alimentatore on/off 24VDC
Note: module de variation AL7035 d'intensité à utiliser en combinaison avec une alimentation on/off 24VDC
Anmerkung: Dimmmodul AL7035 zur Verwendung in Kombination mit einem on/off 24VDC-Netzteil
Nota: módulo de regulación AL7035 se utiliza en combinación con una fuente de alimentación on/off 24VDC

DIG 6

design: Rod&Todd

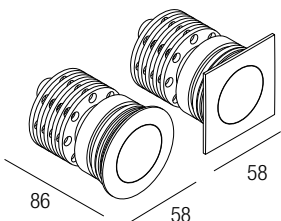

Supply current

Alimentazione
 Courant d'alimentation
 Stromversorgung
 Corriente de alimentación
500 mA (V, 9V)

Power

Potenza
 Pouissance
 Bestuekung
 Potencia
6 W

Series wiring

Cablaggio in serie
 Câblage en série
 Verkabelung in Serie
 Cableado en serie



Photometric diagrams

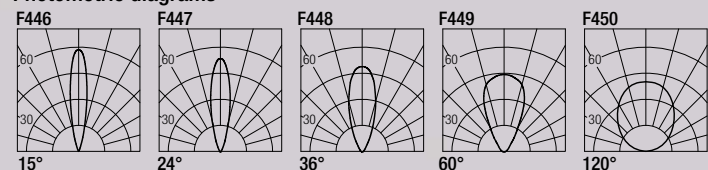

CCT/CRI/Flux

2700K — 540 lm
 3000K — 600 lm
 4000K — 620 lm

CRI98

2-Step MacAdam



Code Construction

Costruzione del codice - Construction du code produit
 Bau der Produkt-Code - Construcción del código de producto

DIG6 X X X X

Beam angle	N	S	M	W	X
Apertura di fascio	15°	24°	36°	60°	120°
Angle de faisceau					
Strahlwinkel					
Ángulo del haz					

Finishing	G	N	K	Z
Finitura	Grey	Black	COR-TEN	INOX AISI
Finitions	Grigio	Nero		316L
Oberflächenfinish	Gris	Noir		Steel
Acabados	Grau	Schwarz		Acciaio
		Negro		Acier
				Stahl
				Acero

Color Temperature	2	3	4
Temperatura colore	2700K	3000K	4000K
Température couleur			
Temperaturabhängige Farbe			
Temperatura de color			

Shape	1	2
Forma	Round	Square
Forme	Tondo	Quadro
Form	Ronde	Carrè
	Runde	Quadrat
	Redondo	Cuadrado

Drivers

Alimentatori - Alimentateurs
 Netzteile - Alimentadores

on/off	dimnable
AL1074 (1.2) 30mm IP20	AL4010 (1.4) 72mm IP20 PUSH 0/1..10V
AL1077 (1.2) 40mm IP20	AL4151 (1.4) 72mm IP20 DALI
AL1084 (1.3) 55mm IP20 S.P.	AL4153 (1.4) 56mm IP20 PUSH IGBT-TRIAC
AL9051 (1.3) 44mm IP67	AL8050 (2.4) IP67 DALI

Accessories

Accessori - Accessoires
 Zubehör - Accesorios

CSDS10

Recessing box
 Controcassa
 Boîtier d'encastrement
 Eingießgehäuse
 Caja de empotrar

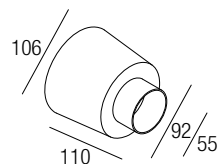

LDIG601

Low luminance louver
 Filtro antiabbagliamento
 Filtre basse luminance
 Geringe Leuchtdichte-Filter
 Filtro de baja luminancia

Note: the filter must be ordered together with the lighting fixture - **Nota:** il filtro deve essere ordinato congiuntamente all'apparecchio - **Note:** le filtre doit être commandé en même temps que l'appareil - **Anmerkung:** muss der Filter zusammen mit Leuchtkörper bestellt werden
Nota: el filtro debe pedirse junto con la luminaria

Note: cable cut to measure on request
Nota: cavo a misura disponibile su richiesta
Note: câble sur mesure disponible sur demande
Anmerkung: kundenspezifisches Kabel auf Anfrage erhältlich
Nota: cable a medida disponible a petición



DIG 10

design: Rod&Todd

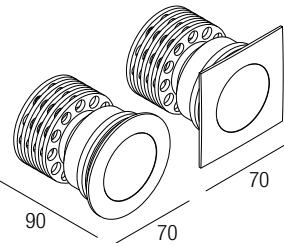

Supply current

Alimentazione
Courant d'alimentation
Stromversorgung
Corriente de alimentación

500 mA (V_i 18V)

Power

Potenza
Puissance
Bestuekung
Potencia

10 W

Series wiring

Cablaggio in serie
Câblage en série
Verkabelung in Serie
Cableado en serie

CCT/CRI/Flux

	CRI85	CRI93
2700K	890 lm	840 lm
3000K	1000 lm	930 lm
4000K	1040 lm	960 lm

CRI85 - CRI93
2-Step MacAdam



Photometric diagrams

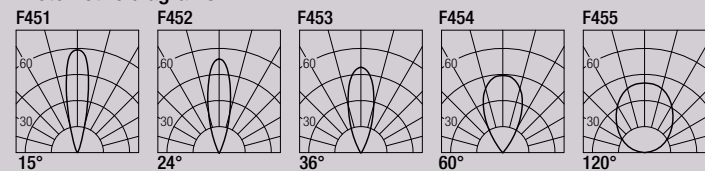

Code Construction

Costruzione del codice - Construction du code produit
Bau der Produkt-Code - Construcción del código de producto

DIG1 X X X X X

Beam angle N S M W X
Apertura di fascio 15° 24° 36° 60° 120°
Angle de faisceau
Strahlwinkel
Ángulo del haz

Finishing G N K Z
Finitura Grey Black COR-TEN INOX AISI
Finitions Gris Nero 316L
Oberflächenfinish Acabados
Gris Noir Schwarz Acier Stahl Acero

CRI 8 9
85 93

Color Temperature 2 3 4
Temperatura colore 2700K 3000K 4000K
Température couleur
Temperaturabhängige Farbe
Temperatura de color

Shape 1 2
Forma Round Square
Forme Tondo Quadro
Forme Ronde Carré
Forme Runde Quadrat
Forme Redondo Cuadrado

Accessories

Accessori - Accessoires
Zubehör - Accesorios

CSXJ01

Recessing box
Controcassa
Boîtier d'encastrement
Eingieβgehäuse
Caja de empotrar

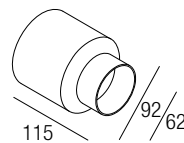

LDIG101

Low luminance louver
Filtro antiabbagliamento
Filtre basse luminance
Geringe Leuchtdichte-Filter
Filtro de baja luminancia



Note: the filter must be ordered together with the lighting fixture - **Nota:** il filtro deve essere ordinato congiuntamente all'apparecchio - **Note:** le filtre doit être commandé en même temps que l'appareil - **Anmerkung:** muss der Filter zusammen mit Leuchtkörper bestellt werden
Nota: el filtro debe pedirse junto con la luminaria

Note: cable cut to measure on request
Nota: cavo a misura disponibile su richiesta
Note: câble sur mesure disponible sur demande
Anmerkung: kundenspezifisches Kabel auf Anfrage erhältlich
Nota: cable a medida disponible a petición

Drivers

Alimentatori - Alimentateurs
Netzteile - Alimentadores

on/off	dimnable
AL1074 (1) 30mm IP20	AL4010 (1.2) 72mm IP20 PUSH 0/1..10V
AL1077 (1) 40mm IP20	AL4151 (1.2) 72mm IP20 DALI
AL1084 (1.2) 55mm IP20 S.P.	AL4153 (1.2) 56mm IP20 PUSH IGBT-TRIAC
AL9051 (1.2) 44mm IP67	AL8050 (1.2) IP67 DALI

DIG 724

design: Rod&Todd

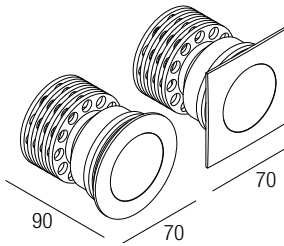

Supply current

Alimentazione
Courant d'alimentation
Stromversorgung
Corriente de alimentación

24 VDC

Power

Potenza
Puissance
Bestuekung
Potencia

7 W

Parallel wiring

Cablaggio in parallelo
Câblage en parallèle
Verkabelung in parallel
Cableado en paralelo

CCT/CRI/Flux

	CRI85	CRI93
2700K	630 lm	590 lm
3000K	700 lm	650 lm
4000K	730 lm	670 lm

CRI85 - CRI93
2-Step MacAdam



Photometric diagrams

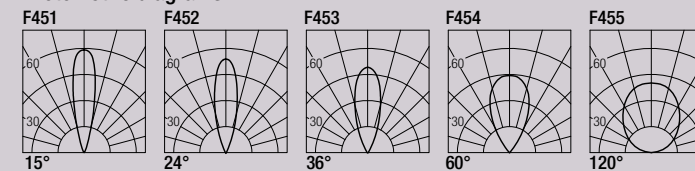

Code Construction

Costruzione del codice - Construction du code produit
Bau der Produkt-Code - Construcción del código de producto

DIG24 X X X X X

Beam angle N S M W X
Apertura di fascio 15° 24° 36° 60° 120°
Angle de faisceau
Strahlwinkel
Ángulo del haz

Finishing G N K Z
Finitura Grey Black COR-TEN INOX AISI
Finitions Gris Nero 316L
Oberflächenfinish Acabados
Gris Noir Schwarz Acier Stahl Acero

CRI 8 9
85 93

Color Temperature 2 3 4
Temperatura colore 2700K 3000K 4000K
Température couleur
Temperaturabhängige Farbe
Temperatura de color

Shape 1 2
Forma Round Square
Forme Tondo Quadro
Forme Ronde Carré
Forme Runde Quadrat
Forme Redondo Cuadrado

Accessories

Accessori - Accessoires
Zubehör - Accesorios

CSXJ01

Recessing box
Controcassa
Boîtier d'encastrement
Eingieβgehäuse
Caja de empotrar

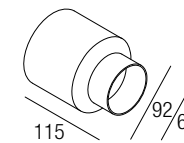

LDIG2401

Low luminance louver
Filtro antiabbagliamento
Filtre basse luminance
Geringe Leuchtdichte-Filter
Filtro de baja luminancia



Note: the filter must be ordered together with the lighting fixture - **Nota:** il filtro deve essere ordinato congiuntamente all'apparecchio - **Note:** le filtre doit être commandé en même temps que l'appareil - **Anmerkung:** muss der Filter zusammen mit Leuchtkörper bestellt werden
Nota: el filtro debe pedirse junto con la luminaria

Note: cable cut to measure on request
Nota: cavo a misura disponibile su richiesta
Note: câble sur mesure disponible sur demande
Anmerkung: kundenspezifisches Kabel auf Anfrage erhältlich
Nota: cable a medida disponible a petición

Drivers

Alimentatori - Alimentateurs
Netzteile - Alimentadores

on/off	dimming module	dimmable
AL2012 (1..3) 60mm IP20	AL7035 IP20 PUSH DALI 0/1..10V	AL5012 (1..3) 45mm IP20 PUSH DALI 0/1..10V
AL2031 (1..10) 70mm IP20		AL8012 (1..3) IP67 DALI
AL2040 (1..21) 80mm IP20	Note: dimming module AL7035 to be used in combination with an on/off 24VDC power supply Nota: modulo di dimmerazione AL7035 da utilizzare in combinazione con un alimentatore on/off 24VDC Note: module de variation AL7035 d'intensité à utiliser en combinaison avec une alimentation on/off 24VDC Anmerkung: Dimmmodul AL7035 zur Verwendung in Kombination mit einem on/off 24VDC-Netzteil Nota: módulo de regulación AL7035 se utiliza en combinación con una fuente de alimentación on/off 24VDC	
AL9212 (1..2) 110mm IP67		
AL9231 (1..10) 85mm IP67		
AL9240 (1..21) 85mm IP67		

MAUNA 6

design: Rod&Todd

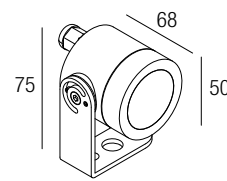

Supply current

Alimentazione
Courant d'alimentation
Stromversorgung
Corriente de alimentación
500 mA (V_i 9V)

Power

Potenza
Puissance
Bestuekung
Potencia
6 W

Series wiring

Cablaggio in serie
Câblage en série
Verkabelung in Serie
Cableado en serie



Photometric diagrams

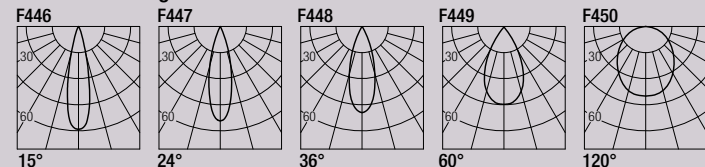

CCT/CRI/Flux

2700K — 540 lm
3000K — 600 lm
4000K — 620 lm

CRI98
2-Step MacAdam

Note: cable cut to measure on request
Nota: cavo a misura disponibile su richiesta
Note: câble sur mesure disponible sur demande
Anmerkung: kundenspezifisches Kabel auf Anfrage erhältlich
Nota: cable a medida disponible a petición

Code Construction

Costruzione del codice - Construction du code produit
Bau der Produkt-Code - Construcción del código de producto

MU6 X X X X

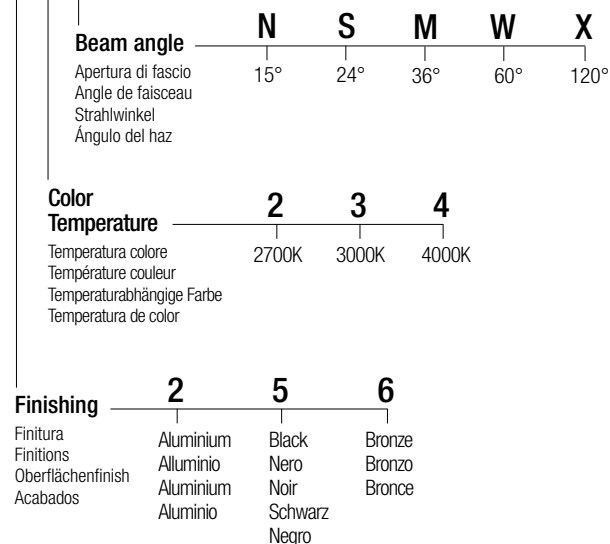

Drivers

Alimentatori - Alimentateurs
Netzteile - Alimentadores

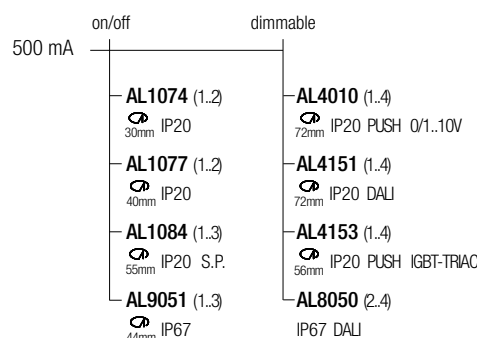

Accessories

Accessori - Accessoires
Zubehör - Accesorios

XP0022

Earth spike
Picchetto
Piquet de terre
Erdspeiß
Pico de la tierra

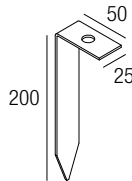

XP0200

Aluminium
Aluminio
Aluminium
Aluminio

XP0500

Black
Nero
Noir
Schwarz
Negro

XP0600

Bronze
Bronzo
Bronce

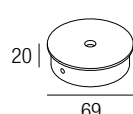

Base
Basis

LMU601

Low luminance louver
Filtro antiabbagliamento
Filtre basse luminance
Geringe Leuchtdichte-Filter
Filtro de baja luminancia



Note: the filter must be ordered together with the lighting fixture - **Nota:** il filtro deve essere ordinato congiuntamente all'apparecchio - **Note:** le filtre doit être commandé en même temps que l'appareil - **Anmerkung:** muss der Filter zusammen mit Leuchtkörper bestellt werden
Nota: el filtro debe pedirse junto con la luminaria

XNTM02

Aluminium
Aluminio
Aluminium
Aluminio

XNTM05

Black
Nero
Noir
Schwarz
Negro

XNTM06

Bronze
Bronzo
Bronce

Antiglare snoot
Snoot antiabbagliamento
Snoot antiéblouissement
Blendschutz Snoot
Snoot antideslumbrante



XXT01

Tree strap
Cinghia per albero
Courroie d'arbre
Baumbügel
Correa del árbol

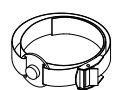

MAUNA 724

design: Rod&Todd

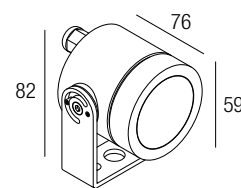

Supply current

Alimentazione
Courant d'alimentation
Stromversorgung
Corriente de alimentación
24 VDC

Power

Potenza
Puissance
Bestuekung
Potencia
7 W

Parallel wiring

Cablaggio in parallelo
Câblage en parallèle
Verkabelung in parallel
Cableado en paralelo



Photometric diagrams

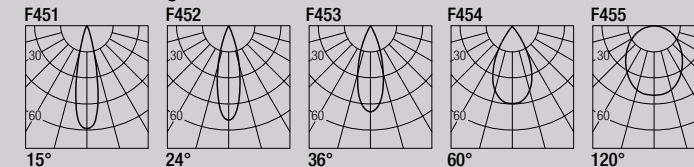

CCT/CRI/Flux

CRI85 CRI93
2700K — 630 lm 590 lm
3000K — 700 lm 650 lm
4000K — 730 lm 670 lm

CRI85 - CRI93
2-Step MacAdam

Note: cable cut to measure on request
Nota: cavo a misura disponibile su richiesta
Note: câble sur mesure disponible sur demande
Anmerkung: kundenspezifisches Kabel auf Anfrage erhältlich
Nota: cable a medida disponible a petición

Code Construction

Costruzione del codice - Construction du code produit
Bau der Produkt-Code - Construcción del código de producto

MU24 X X X X

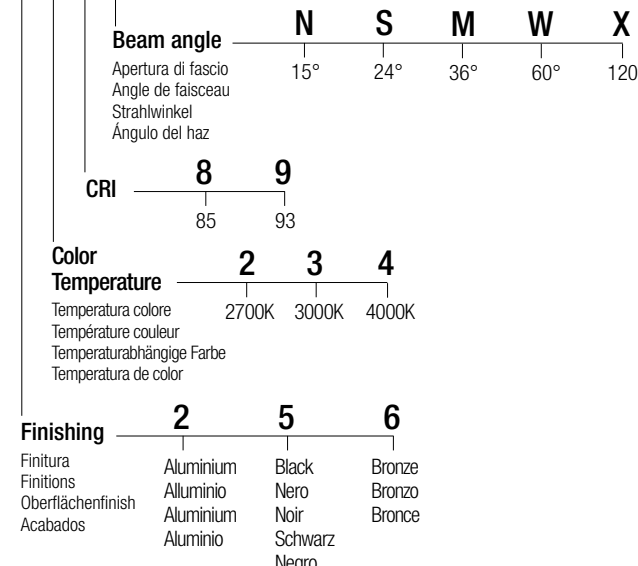

Drivers

Alimentatori - Alimentateurs
Netzteile - Alimentadores

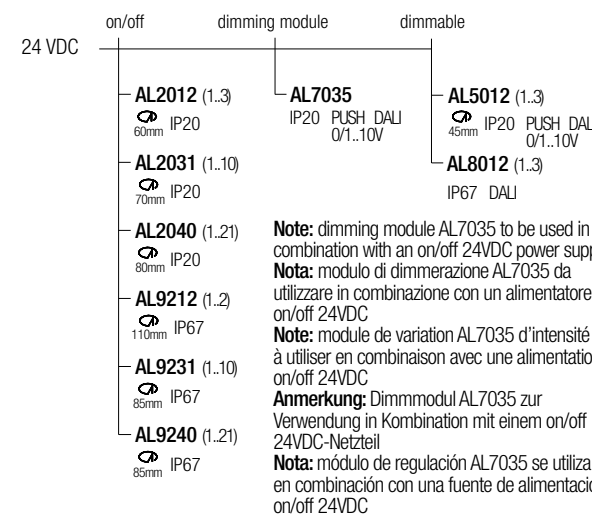

Accessories

Accessori - Accessoires
Zubehör - Accesorios

ESMU2401

Earth spike
Picchetto
Piquet de terre
Erdspeiß
Pico de la tierra

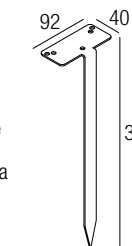

XP0200

Aluminium
Aluminio
Aluminium
Aluminio

XP0500

Black
Nero
Noir
Schwarz
Negro

XP0600

Bronze
Bronzo
Bronce

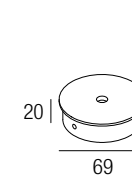

Base
Basis

LMU2401

Low luminance louver
Filtro antiabbagliamento
Filtre basse luminance
Geringe Leuchtdichte-Filter
Filtro de baja luminancia



Note: the filter must be ordered together with the lighting fixture - **Nota:** il filtro deve essere ordinato congiuntamente all'apparecchio - **Note:** le filtre doit être commandé en même temps que l'appareil - **Anmerkung:** muss der Filter zusammen mit Leuchtkörper bestellt werden
Nota: el filtro debe pedirse junto con la luminaria

XNTX202

Aluminium
Aluminio
Aluminium
Aluminio

XNTX205

Black
Nero
Noir
Schwarz
Negro

XNTX206

Bronze
Bronzo
Bronce

Antiglare snoot
Snoot antiabbagliamento
Snoot antiéblouissement
Blendschutz Snoot
Snoot antideslumbrante



XXT01

Tree strap
Cinghia per albero
Courroie d'arbre
Baumbügel
Correa del árbol

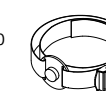

FLEXALIGHTING

Flexalighting is part of the group
Italian Design Brands © 2020

Via Lisbona 21
50065 Pontassieve
Firenze, Italy

ph +39.055.83.23.021
fax +39.055.83.24.866

- ▶ info@flexalighting.it
- ▶ www.flexalighting.it

