

lighting guide

TRONIX guided by light







Care

We care for our clients. We help them do what they do best. We strive to build a long-term relationship, so that we can rely on one another unconditionally.

We zorgen voor onze klanten. We helpen ze te doen waar ze goed in zijn. We streven naar een duurzame relatie, zodat we onvoorwaardelijk op elkaar kunnen bouwen.

Light connects. It creates atmosphere, experiences and emotion. As a comprehensive LED supplier, we have the perfect answer for any light-related question. For you, for ourselves, and out of respect for the beauty around us. We're guided by light.



Share

Knowledge is power, but sharing is even more powerful. Because sharing means: growing together. We as a supplier, and our client as an authority/specialist for their own clients.

Kennis is kracht, kennis delen is nog veel krachtiger. Want delen betekent: samen groeien. Wij als leverancier, en onze klant als autoriteit/specialist voor zijn eindklant.



Connect

We connect people and partners. Together, we can make one plus one equal three. We see the market as a dynamic playing field, where together we can make 'beautiful' even more beautiful!

We verbinden mensen en partijen. Samen maken we van één plus één drie. We zien de markt als een dynamisch speelveld, waarin we samen 'mooi' nog mooier maken.



TRONIX guided by light

Lighting guide 2022

🇬🇧 Our stock-holding product selection is bigger than big: We can provide anything you need, so you don't have to shop around. With our led solutions for every light application, your project is in good hands with our light experts. We bring lighting solutions that excel in function ánd wow factor.

Whether we do it from scratch or via reverse engineering, we always develop products using the best components, technical specifications and contemporary designs. Quality and satisfied customers are our first priorities. As light pioneers, we have a partner network that reaches around the globe, giving us a leading position with first-class light. You do business with us, we'll do business with the rest of the world. And going that extra mile for you is just in our DNA.

🇳🇱 Ons aanbod is groter dan groot en uit voorraad leverbaar. Bij ons vind je wat je zoekt, gewoon op één adres. Met led-oplossingen voor elke lichttoepassing is je project hier in goede handen. Wij gaan voor lichtoplossingen die uitblinken in functie én wow-factor.

Van 'scratch' of vanuit een bestaand ontwerp (reverse engineering) ontwikkelen we producten met de beste componenten, technische specificaties en eigentijdse designs. Kwaliteit en tevreden klanten staan bij ons op nummer één. Als lichtpioniers hebben we een wereldwijd partner netwerk voor een koppositie met eersteklas licht. Jij doet zaken met ons, wij met de rest van de wereld. En die extra stap zetten we graag voor je, dat zit gewoon in ons DNA.





Office and showroom in Uden - The Netherlands



Looking for our latest product releases? We keep continued focus on new product development and further extension of our range. Visit our website for a most actual overview.

Op zoek naar onze allernieuwste producten? We werken voortdurend aan nieuwe productontwikkeling en een verdere uitbreiding van ons assortiment. Bezoek onze website voor het meest actuele overzicht!



Order online? Ask for your personal login account at sales@tronixlighting.com

Orders placed before 12.00h (GMT +1) will be shipped the same day

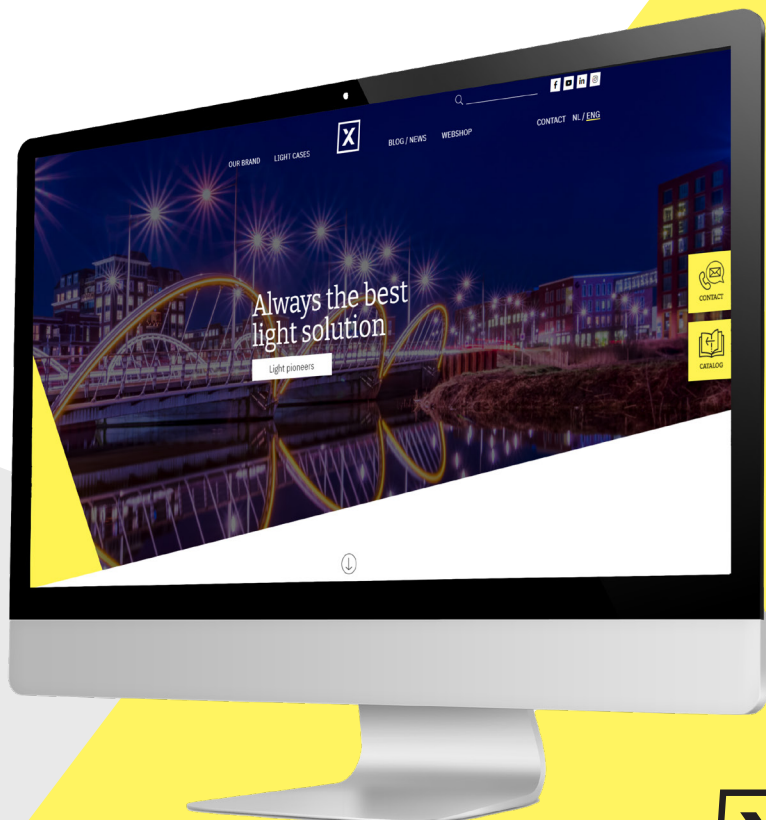

Check our complete
catalog range online

Bekijk alle Tronix product
catalogi online



Light design & technology 2022



light design & technology









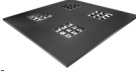

TRONIX guided by light



TRONIX guided by light



Content

1. downlights & spots		10
2. panels		28
3. ceiling & wall lights		42
4. track light		60
5. recessed fixtures		68
6. led tl's & lamps		76
7. emergency light		86
8. high bays		98
9. industrial fixtures & line lighting		104
10. flood light		112
11. area lighting		116
12. garden lights & ground spots		122

Photography / Fotografie:



Fenna Gijswijt fotografie /



Hans Koster /



Ronald Strijbosch / Margot van den Nieuwenhuizen

Adobe Stock Foto's

The images and information provided in this catalogue are composed with great care, but may be always subject to alterations. Tronix Lighting accepts no liability for misprints, errors or unforeseen changes.

De beelden en informatie zoals deze zijn weergegeven in deze catalogus zijn met zorg samengesteld maar blijven altijd onder voorbehoud. Tronix Lighting accepteert geen aansprakelijkheid voor drukfouten en onvoorziene wijzigingen.

Technical indications

There is a lot to know about light and we think it is important to share this knowledge with you. Why? Because we place high demands on the quality of our lighting products, and this information will help you to qualify and compare products better. Below overview of important technical specifications and measurement factors can be of help.

CRI value

The Color Rendering or Color Rendering Index (CRI value) tells you on a scale of 0-100% how 'true' a light source represents the colors compared to real daylight. The higher the CRI value of a light source, the more real the colors. A CRI value value of 80 means a quite high color rendering; CRI value values of 90 or more have an excellent color rendering.

Dimming

LED can be dimmed in many ways. A primary condition is that the LED lamp itself is suitable for dimming, and also the dimmer must be fit for controlling the LED. On top of that, the driver needs to be suitable for the combination of dimmer and LED lamp. And there is a difference of control between LED dimmers: it can be analogue (0-10 V, 1-10V, trailing edge dimming) or digital (DALI, Casambi dimming).

EIA

Led lighting is eligible for energy investment deduction (EIA) in a number of countries. This concerns subsidy money that allows you to deduct 45% of the investment (luminaires + assembly) from the profit tax. To qualify for this subsidy, LED lighting fixtures meet the lifespan criteria L90B50 at 50.000 hours and must be measured in accordance with LM-80.

Flicker-free

The flickering of a light source is expressed in a Flicker percentage, and caused by the quality of the used Led driver. The lower the percentage, the better. A Flicker value > 35% is experienced as very annoying; values up to 15% can cause fatigue or headaches. All Tronix lighting and LED drivers have a flicker percentage below <1% and therefore meet all current EPREL requirements.

IP rate

Ingress Protection (International Protection Rating) of a product, normalized to the IEC60529 standard. The IP value is expressed in 2 digits; the first number indicates the protection value against dust/touch, the second number the protection value against moisture. In case of Led lighting, IP ratings vary from IP20, non- or poorly resistant to dust and moisture, up to IP68 - water resistant and 100% dust resistant.

IK rate

The Impact Protection Rating says something about the impact resistance of a luminaire, so to what extent it is resistant to mechanical shocks. In practice, this value varies from IK02 to IK10. The higher the IK value, the higher the impact resistance. Tronix wall/ceiling luminaires vary in value from IK08 (resistant to 5 Joule shocks) to IK10 (vandal-proof with a 20 Joule shock resistance).

Kelvin

The Kelvin (K) value indicates the color temperature. The lower the Kelvin value, the warmer the light looks. The higher the number of Kelvin, the 'colder' the light. The standard Kelvin values for Led lighting start at 2300K (warm white) to 7000K (cold white).

Lifespan

The lifespan of Led is many times longer than that of conventional lighting, such as incandescent lamps. A good Led easily achieves a lifespan of 50,000 hours, however the actual lifetime of the Led strongly depends on the ambient temperature (in connection with cooling), and the electronics used. The more stable the strength of current, the longer the lifespan. The humidity level of the Led environment is also an influential factor. In the course of time, it is however inevitable that the Luminous flux will eventually decrease to a maximum of 70%.

Luminous flux

The amount of light (current) that a light source produces, in other words the sum of all emitted light, regardless of the direction in which the light shines. The Luminous flux value is often expressed as Luminous flux per Watt, which expresses the efficiency of the LED. With a Luminous flux of >130 Lm / Watt, Tronix High Efficiency Panels score very high on an operating efficiency level, making them eligible for EIA.

LUX

The amount of lux is the most reliable measurement value for lighting and says something about the amount of light (Luminous flux) that ends up on a certain surface. 1 lux = 1 Lm / m². For example: a light source of 1000 Lm spread over 1 m² illuminates that square meter with 1000 Lux. Spread that same 1000 Lm over 10m², and it will then only illuminate 100 Lux. European standards for lux values in various interior lighting environments are captured in NEN 1246-1 regulations.

Power factor

The power factor represents the relationship between the actual power (P) and the apparent power (Ps). The lower the power factor, the higher the unwanted power consumption. High quality Led lighting has a power factor of at least 0.90 and is now running up to 0.95 (max. 5% undesired power consumption). Inferior LED products have a considerably lower power factor; In addition to higher electricity costs, this also results in dangerous situations due to the large amount of reactive current.

UGR

The Unified Glare Rating indicates the degree of light nuisance or glare. The average value is between 15 and 30. Below 10 there is no glare.

Communication protocol

With a large variation in control and dimming techniques, the possibilities with the current Tronix range are endless. For example; we have DALI, Casambi, ZigBee, DMX, Triac and 1-10V. Can't find the right protocol? Each fixture can be supplied with integrated control in any desired protocol, simply ask us about the options and possibilities.

Technische aanduidingen

Er is veel te weten over licht en wij vinden het belangrijk om deze kennis met u te delen. Waarom? Omdat we hoge eisen stellen aan de kwaliteit van onze verlichting, en deze informatie u zal helpen om producten beter te beoordelen en met elkaar te vergelijken. Onderstaand overzicht van belangrijke technische specificaties en meefactoren zijn hierbij een helpende hand.



CRI value

De kleurweergave of Color Rendering Index (CRI value) geeft op een schaal van 0-100% aan hoe 'kleurecht' een lichtbron de kleuren weergeeft in vergelijking tot daglicht. Hoe hoger de CRI value van een lichtbron, hoe echter de kleuren. Een CRI value waarde van 80 betekent een hoge kleurweergave; CRI value waarden van 90 of meer hebben een uitstekende kleurweergave.



Dimming

Led is op vele manieren te dimmen. Voorwaarde is wel dat de led lamp zelf geschikt is om te dimmen en de dimmer moet ook geschikt zijn voor het aansturen van de Led. Bij aanwezigheid van een driver moet deze daarnaast ook geschikt zijn voor de combinatie dimmer en led lamp. Tussen led dimmers zit ook nog een verschil van aansturing, deze kan Analoog (0-10 V, 1-10V, Fase Aan-/afsnijding Dimming) of Digitaal zijn (DALI, Casambi).



EIA

Led verlichting komt in een aantal landen in aanmerking voor energie investeringsaftrek, een subsidiepotje waarbij men 45% van de investering (armaturen + montage) mag aftrekken van de winstbelasting. Om voor deze subsidie in aanmerking te komen moet het armatuur aan de levensduurcriteria L90B50 bij 50.000 uur en dienen gemeten te zijn conform LM-80.



Flikkervrij

Het knipperen van een lichtbron wordt uitgedrukt in een Flikkerpercentage, en veroorzaakt door de kwaliteit van de gebruikte Led driver. Hoe lager het percentage, hoe beter. Een Flikkerwaarde >35% wordt als zeer hinderlijk ervaren; waarden tot 15% kunnen vermoeidheids- of hoofdpijnklachten veroorzaken. Alle Tronix verlichting en led drivers hebben een Flikkerpercentage onder de <1% en voldoen daarmee aan alle huidige EPREL eisen.



IP rate

Ingress Protection (International Protection Rating) van een product, genormaliseerd volgens de IEC60529 norm. De IP waarde wordt in 2 cijfers uitgedrukt; het eerste getal geeft de beschermwaarde aan tegen stof/aanraken, het tweede getal de beschermwaarde tegen vocht. In de Led verlichting variëren de IP ratings van IP20 – niet (goed)bestendig tegen stof en vocht – tot aan IP68 – waterbestendig en 100% stofbestendig.



IK rate

De Impact Protection Rating zegt iets over de slagvastheid van een armatuur, dus in hoeverre deze bestand is tegen mechanische schokken. In de praktijk varieert deze waarde van IK02 tot IK10. Hoe hoger de IK waarde, hoe hoger de slagvastheid. De wand-/plafondarmaturen van Tronix variëren in waarde van IK08 (weerstand tegen schokken van 5 Joule) tot IK10 (vandalismebestendig met een weerstand tegen schokken van 20 Joule).



Kelvin

De Kelvin (K) waarde duidt op de kleurtemperatuur. Hoe lager de K waarde, hoe warmer het licht oogt. Hoe hoger het aantal Kelvin, hoe 'kouder' het licht. De standaard Kelvin-waarden beginnen bij 2300K (warm wit) tot 7000K (koud wit).



levensduur

De levensduur van led-verlichting is vele malen langer dan dat van conventionele verlichting zoals gloei- en halogeenlampen. Een goede led haalt makkelijk een levensduur van 50.000 uur, echter de uiteindelijke levensduur van de led is sterk afhankelijk van de omgevingstemperatuur (i.v.m. koeling), en de gebruikte elektronica. Hoe stabielere de stroomsterkte hoe langer de levensduur. Ook de vochtigheidsgraad van de led omgeving is nog van invloed. Overigens loopt de lichtopbrengst na verloop van tijd wel enigszins terug tot maximaal 70%.



Luminous flux

De hoeveelheid licht(stroom) die een lichtbron oplevert, oftewel de som van al het uitgestraalde licht ongeacht de richting waarin het licht straalt. De Luminous flux waarde wordt vaak uitgedrukt per stroomeenheid (Lm/W) om de efficiëntie van de led uit te drukken. Tronix High Efficiency Panelen scoren met een lichtopbrengst van >130 Lm /Watt hoog in gebruiksefficiëntie, waardoor deze in aanmerking komen voor EIA.



LUX

De hoeveelheid lux is de meest betrouwbare meetwaarde voor verlichting en zegt iets over de hoeveelheid licht (Luminous flux) die er op een bepaald oppervlak terecht komt. 1 lux = 1 Lm/m². Vb: een lichtbron van 1000 Lm, verspreid over 1 m², verlicht die vierkante meter met 1000 Lux. Verspreid over 10m² verlicht die zelfde 1000 Lm slechts 100 Lux. De gestelde Europese normen voor luxwaarden in diverse binnenverlichtingsomgevingen zijn vastgelegd in NEN 1246-1.



Power factor

De power factor geeft de relatie weer tussen het werkelijke vermogen (P) en het schijnbare vermogen (Ps). Hoe lager de power factor, hoe hoger het ongewenste stroomverbruik. Hoge kwaliteit led verlichting heeft een powerfactor van minimaal 0,90 en loopt inmiddels tegen de 0,95 (max. 5% ongewenst stroomverbruik). Inferieure led producten hebben een aanzienlijk lagere power factor; behalve hogere stroomkosten levert dit ook gevaarlijke situaties op door de grote hoeveelheid blindstroom.



UGR

De Unified Glare Rating geeft aan in hoeverre er sprake is van lichthinder of verblinding. De gemiddelde waarde licht tussen de 15 en de 30. Beneden de 10 is er geen sprake van verblinding.



Communicatieprotocol

Met een grote variatie in aansturing en dimtechnieken zijn de mogelijkheden met het huidige Tronix verlichtingsassortiment eindeloos. Zo beschikken we over DALI, Casambi, ZigBee, DMX, Triac en 1-10V. Toch niet het juiste protocol beschikbaar? Elk armatuur is te leveren met geïntegreerde aansturing in elk gewenst protocol. Vraag ons naar de opties en mogelijkheden.

1

Downlights

The right solution for a wide
variety in applications





Downlights & Spots

DOWNLIGHT FLAT | TRI-WHITE | BLACK DIMMABLE



With CCT switch for pre-settable color temperature 3000K - 4000K - 5700K

Input voltage: 240V
Power: 7/10/15 Watt
Driver: External driver included
Dimming method: Triac
Beam angle: 120°
IP rate: IP20
Mounting: Recessed
Cable length: 200 cm
Connection type: Europlug
Housing frame: Aluminium (black coated)



ART. NR.	POWER	LUMINOUS FLUX	LIGHT COLOR	DIAMETER Ø	HEIGHT	MOUNTING HOLE
136-185	7 Watt	410-450-480 Lm	Tri-white	Ø 120 mm	21 mm	Ø 105 mm
136-186	10 Watt	620-670-720 Lm	Tri-white	Ø 173 mm	21 mm	Ø 160 mm
136-187	10 Watt	620-670-720 Lm	Tri-white	Ø 200 mm	21 mm	Ø 185 mm
136-189	15 Watt	950-990-1130 Lm	Tri-white	Ø 240 mm	21 mm	Ø 220 mm

DOWNLIGHT FLAT | TRI-WHITE | WHITE DIMMABLE



With CCT switch for pre-settable color temperature 3000K - 4000K - 5700K

Input voltage: 240V
Power: 7/10/15 Watt
Driver: External driver included
Dimming method: Triac
Beam angle: 120°
IP rate: IP20
Mounting: Recessed
Cable length: 200 cm
Connection type: Europlug
Housing frame: Aluminium (white coated)

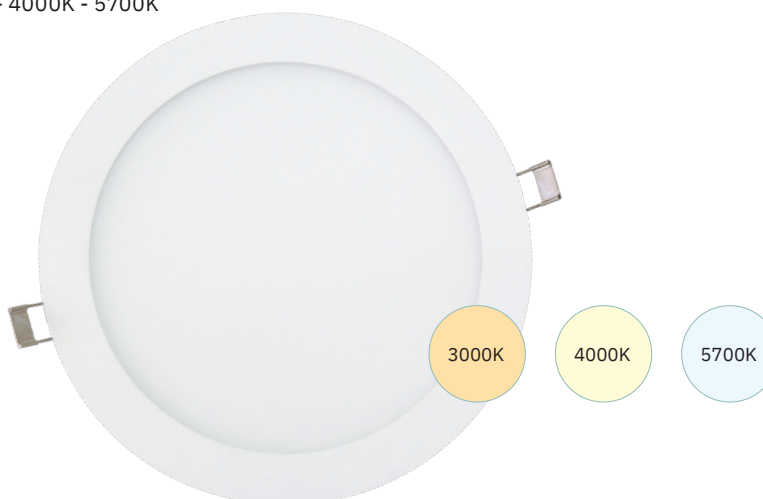

ART. NR.	POWER	LUMINOUS FLUX	LIGHT COLOR	DIAMETER	HEIGHT	MOUNTING HOLE
136-180	7 Watt	410-450-480 Lm	Tri-white	Ø 120 mm	21 mm	Ø 105 mm
136-181	10 Watt	620-670-720 Lm	Tri-white	Ø 173 mm	21 mm	Ø 160 mm
136-182	10 Watt	620-670-720 Lm	Tri-white	Ø 200 mm	21 mm	Ø 185 mm
136-183	15 Watt	900-970-1030 Lm	Tri-white	Ø 224 mm	21 mm	Ø 210 mm
136-184	15 Watt	950-990-1130 Lm	Tri-white	Ø 240 mm	21 mm	Ø 220 mm

Downlights & Spots

DOWNLIGHT TRI-WHITE PRESETTABLE

With CCT switch for pre-settable color temperature 3000K - 4000K - 6000K



- Input voltage:** 220-240V
- Power:** 10/14/18/20/30/40 Watt
- Driver:** External Class A driver Eaglerise (non-dimmable) included
- Dimmable:** Optional
- Beam angle:** 50°
- IP rate:** IP20
- Mounting:** Recessed
- Wire length:** 1,2 m
- Connection type:** Europlug
- Housing frame:** Aluminium
- Housing color:** White

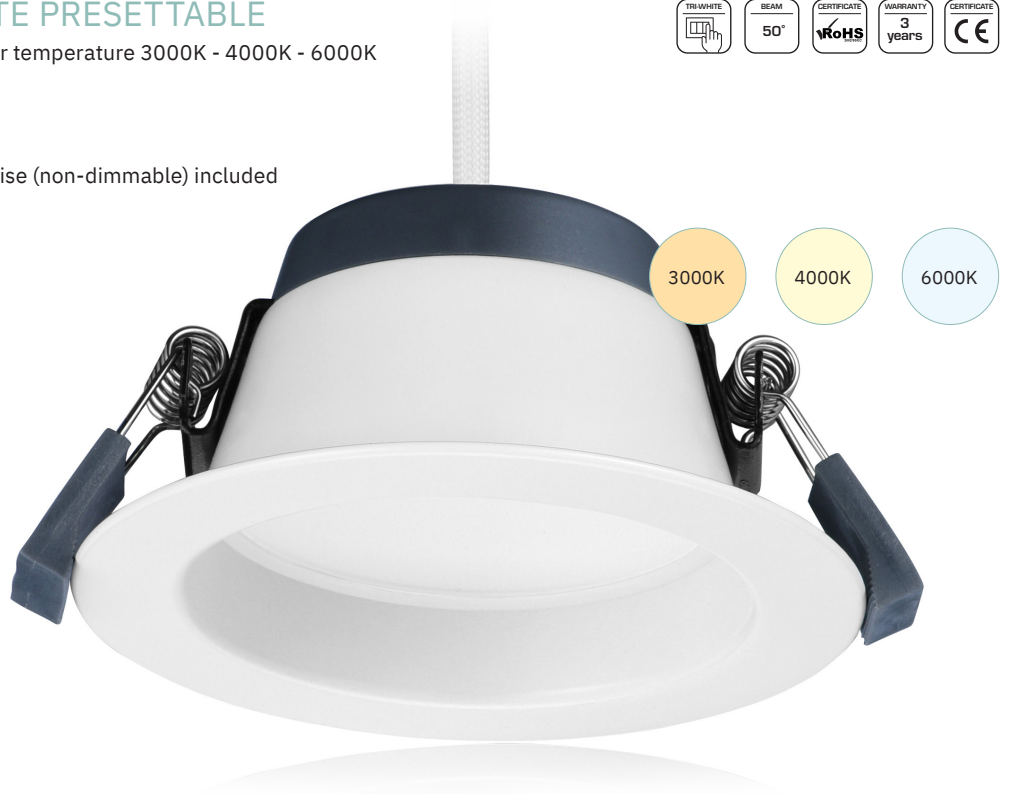

ART.NR.	POWER	LUMINOUS FLUX	LIGHT COLOR	DIAMETER	HEIGHT	MOUNTING HOLE
136-122	10 Watt	780/850/850 Lm	Tri-white	Ø 113 mm	57 mm	Ø 90-98 mm
136-124	14 Watt	1090/1170/1170 Lm	Tri-white	Ø 143 mm	61 mm	Ø 117-127 mm
136-125	18 Watt	1440/1550/1550 Lm	Tri-white	Ø 165 mm	63 mm	Ø 135-145 mm
136-126	20 Watt	1600/1720/1720 Lm	Tri-white	Ø 200 mm	68 mm	Ø 168-178 mm
136-127	30 Watt	2610/2820/2820 Lm	Tri-white	Ø 230 mm	75 mm	Ø 192-210 mm
136-128	40 Watt	3600/3880/3880 Lm	Tri-white	Ø 279 mm	94 mm	Ø 240-255 mm

DIMMABLE DRIVERS

ART. NR.	TRIAC	1-10V	DALI
136-122	215-280	215-517	215-267
136-124	215-280	215-517	215-267
136-125	215-280	215-517	215-267
136-126	215-281	215-509	215-265
136-127	215-282	215-509	215-265
136-128	215-214	215-509	215-505

Downlights & Spots

DOWNLIGHT TRI-WHITE PRESETTABLE

With CCT switch for pre-settable color temperature 3000K - 4000K - 6000K.



Input voltage: 220-240V
Power: 7/9/14/17/25 Watt
Driver: internal dimmable driver included
Dimming method: Triac
Beam angle: 90°
IP rate: IP20
Mounting: Recessed
Connection type: Terminal block
Housing frame: Plastic

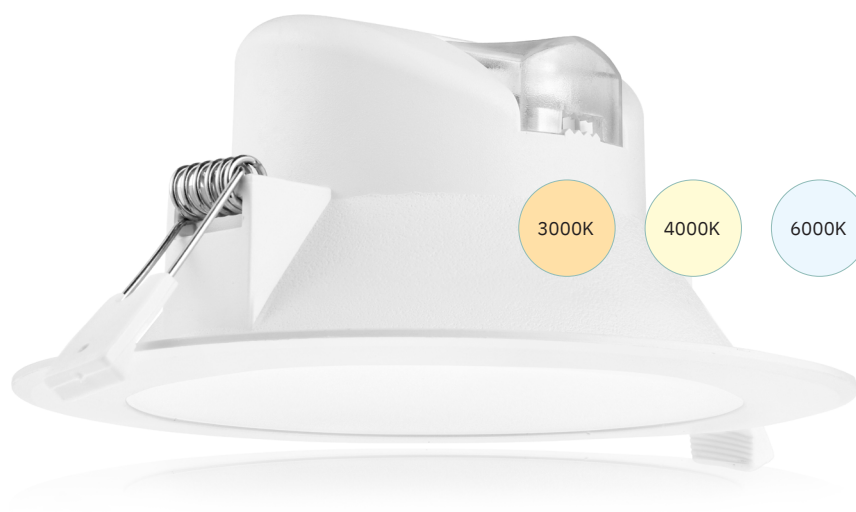

ART.NR.	POWER	LUMINOUS FLUX	LIGHT COLOR	DIAMETER	HEIGHT	MOUNTING HOLE
136-160	7 Watt	560/590/590 Lm	Tri-white	Ø 95 mm	57,5 mm	Ø 68 mm
136-161	9 Watt	750/800/800 Lm	Tri-white	Ø 113 mm	58,0 mm	Ø 90 mm
136-162	14 Watt	1200/1260/1260 Lm	Tri-white	Ø 145 mm	65,8 mm	Ø 120 mm
136-163	17 Watt	1450/1530/1530 Lm	Tri-white	Ø 174 mm	68,5 mm	Ø 145 mm
136-164	25 Watt	2330/2450/2450 Lm	Tri-white	Ø 244 mm	84,0 mm	Ø 195 mm

*See page 13 for accessories

TRI-white: always the right color

TRI-white lighting has a so-called CCT switch on the back, so that the lamp can be pre-set in three different light colors. Warm white, natural white and cold white. In this way, you can choose the right light color for your application.

Altijd de juiste kleur

TRI-white verlichting heeft aan de achterkant een zogeheten CCT-switch, waardoor de lamp in drie verschillende lichtkleuren ingesteld kan worden. Warm wit, neutraal wit en koud wit. Zo kan de lichtkleur altijd naar behoefte worden ingesteld.



Downlights & Spots

DOWNLIGHT TRIAC DIMMABLE

“Low entry” professional Downlights that are a worthy opponent to Tronix upper models in price-quality ratio.



Input voltage: 220-240V
Power: 7/10/14/17/25 Watt
Driver: internal dimmable driver included
Dimming method: Triac
Beam angle: 90°
IP rate: IP20
Mounting: recessed
Connection type: Terminal block
Housing frame: Plastic



ART.NR.	POWER	LUMINOUS FLUX	COLOR TEMP.	LIGHT COLOR	DIAMETER	HEIGHT	MOUNTING HOLE
136-140	7 Watt	560 Lm	3000K	○ Warm white	Ø 92 mm	63.5 mm	Ø 68 mm
136-141	7 Watt	630 Lm	4000K	○ Natural white	Ø 92 mm	63.5 mm	Ø 68 mm
136-143	10 Watt	800 Lm	3000K	○ Warm white	Ø 113 mm	72.5 mm	Ø 90 mm
136-144	10 Watt	840 Lm	4000K	○ Natural white	Ø 113 mm	72.5 mm	Ø 90 mm
136-146	14 Watt	1150 Lm	3000K	○ Warm white	Ø 145 mm	75.0 mm	Ø 120 mm
136-147	14 Watt	1200 Lm	4000K	○ Natural white	Ø 145 mm	75.0 mm	Ø 120 mm
136-149	17 Watt	1430 Lm	3000K	○ Warm white	Ø 174 mm	78.5 mm	Ø 145 mm
136-150	17 Watt	1500 Lm	4000K	○ Natural white	Ø 174 mm	78.5 mm	Ø 145 mm
136-152	25 Watt	2230 Lm	3000K	○ Warm white	Ø 244 mm	94.5 mm	Ø 195 mm
136-153	25 Watt	2350 Lm	4000K	○ Natural White	Ø 244 mm	94.5 mm	Ø 195-210 mm

ACCESSORIES

ART.NR.	ACCESSORIES
136-165	Adapter Ring PC Ø83-110 for Mounting hole Ø68
136-166	Adapter Ring PC Ø100-125 for Mounting hole Ø90
136-167	Adapter Ring PC Ø130-150 for Mounting hole Ø120
136-168	Adapter Ring PC Ø155-180 for Mounting hole Ø145
136-169	Adapter Ring PC Ø215-245 for Mounting hole Ø195



Art.nr 136-143 / 136-144 / 136-161
Ø90 mm



Art.nr 136-166



Ø100-125 mm

Downlights & Spots

DOWNLIGHT ROUND ECO

“Low entry” professional Downlights that are a worthy opponent to Tronix upper models in price-quality ratio.



- Input voltage:** 220-240V
- Power:** 6/12/18/20 Watt
- Driver:** Internal driver included
- Dimmable:** No
- Beam angle:** 120°
- IP rate:** IP20 (downlight front IP44)
- Mounting:** Recessed
- Cable length:** 20 cm
- Connection type:** Stripped wire
- Housing frame:** Anti-UV and heat resistant plastic



ART. NR.	POWER	LUMINOUS FLUX	COLOR TEMP.	LIGHT COLOR	DIAMETER	HEIGHT	MOUNTING HOLE
174-300	6 Watt	350 Lm	3000K	○ Warm White	Ø 115 mm	Ø 30 mm	Ø 100-110 mm
174-301	6 Watt	390 Lm	4000K	○ Natural White	Ø 115 mm	Ø 30 mm	Ø 100-110 mm
174-303	12 Watt	780 Lm	3000K	○ Warm White	Ø 170 mm	Ø 32 mm	Ø 150-160 mm
174-304	12 Watt	850 Lm	4000K	○ Natural White	Ø 170 mm	Ø 32 mm	Ø 150-160 mm
174-306	18 Watt	1350 Lm	3000K	○ Warm White	Ø 220 mm	Ø 31 mm	Ø 200-210 mm
174-307	18 Watt	1450 Lm	4000K	○ Natural White	Ø 220 mm	Ø 31 mm	Ø 200-210 mm
174-309	20 Watt	1500 Lm	3000K	○ Warm White	Ø 240 mm	Ø 31 mm	Ø 220-230 mm
174-310	20 Watt	1600 Lm	4000K	○ Natural White	Ø 240 mm	Ø 31 mm	Ø 220-230 mm

ACCESSORIES

ART. NR.	ACCESSORIES
174-315	Surface Mounting Kit for Downlight Round ECO 6 Watt
174-316	Surface Mounting Kit for Downlight Round ECO 12 Watt
174-317	Surface Mounting Kit for Downlight Round ECO 18 Watt
174-318	Surface Mounting Kit for Downlight Round ECO 20 Watt



Surface Mounting Kit



Surface Mounting Kit including Downlight

Downlights & Spots

DOWNLIGHT SQUARE ECO

“Low entry” professional Downlights that are a worthy opponent to Tronix upper models in price-quality ratio.



- Input voltage:** 220-240V
- Power:** 6/12/18 Watt
- Driver:** Internal driver included
- Dimmable:** No
- Beam angle:** 120°
- IP rate:** IP20 (downlight front IP44)
- Mounting:** Recessed
- Cable length:** 20 cm
- Connection type:** Stripped wire
- Housing frame:** Anti-UV and heat resistant plastic



ART. NR.	POWER	LUMINOUS FLUX	COLOR TEMP.	LIGHT COLOR	DIAMETER	HEIGHT	MOUNTING HOLE
174-320	6 Watt	350 Lm	3000K	○ Warm White	115 x 115 mm	30 mm	105 x 105 mm
174-321	6 Watt	390 Lm	4000K	○ Natural White	115 x 115 mm	30 mm	105 x 105 mm
174-323	12 Watt	780 Lm	3000K	○ Warm White	165 x 165 mm	32 mm	155 x 155 mm
174-324	12 Watt	850 Lm	4000K	○ Natural White	165 x 165 mm	32 mm	155 x 155 mm
174-326	18 Watt	1350 Lm	3000K	○ Warm White	220 x 220 mm	31 mm	205 x 205 mm
174-327	18 Watt	1450 Lm	4000K	○ Natural White	220 x 220 mm	31 mm	205 x 205 mm

ACCESSORIES

ART. NR.	ACCESSORIES
174-330	Surface Mounting Kit PC for Downlight Square ECO 6 Watt
174-331	Surface Mounting Kit PC for Downlight Square ECO 12 Watt
174-332	Surface Mounting Kit PC for Downlight Square ECO 18 Watt



Surface Mounting Kit



Surface Mounting Kit including Downlight

Downlights & Spots | Reflector

LED REFLECTOR DOWNLIGHT COB | 10/20/30W WHITE



Input voltage: 220-240V
Power: 10/20/30 Watt
Driver: External driver (Non-dimmable) included
Dimmable: Optional
UGR: <19
Beam angle: 60°
IP rate: IP20
Mounting: Recessed
Cable length: 120 cm
Connection type: Europlug
Housing frame: Glass/Aluminium (white coated)



Universal Plug, Art. nr. 595-033

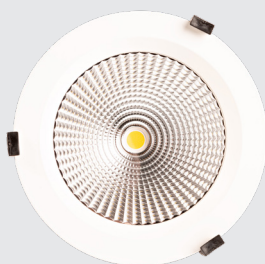

ART. NR.	POWER	LUMINOUS FLUX	LIGHT COLOR	COLOR TEMP.	DIAMETER	HEIGHT	MOUNTING HOLE
136-281	10W	1122 Lm	3000K	● Warm white	Ø 190 mm	75 mm	Ø 160 mm
136-284	10W	1218 Lm	4000K	○ Natural white	Ø 190 mm	75 mm	Ø 160 mm
136-282	20W	2126 Lm	3000K	● Warm white	Ø 190 mm	75 mm	Ø 160 mm
136-285	20W	2342 Lm	4000K	○ Natural white	Ø 190 mm	75 mm	Ø 160 mm
136-283	30W	3115 Lm	3000K	● Warm white	Ø 190 mm	75 mm	Ø 160 mm
136-286	30W	3458 Lm	4000K	○ Natural white	Ø 190 mm	75 mm	Ø 160 mm
136-287	10W	1122 Lm	3000K	● Warm white	Ø 225 mm	87 mm	Ø 200 mm
136-290	10W	1206 Lm	4000K	○ Natural white	Ø 225 mm	87 mm	Ø 200 mm
136-288	20W	2126 Lm	3000K	● Warm white	Ø 225 mm	87 mm	Ø 200 mm
136-291	20W	2382 Lm	4000K	○ Natural white	Ø 225 mm	87 mm	Ø 200 mm
136-289	30W	3115 Lm	3000K	● Warm white	Ø 225 mm	87 mm	Ø 200 mm
136-292	30W	3529 Lm	4000K	○ Natural white	Ø 225 mm	87 mm	Ø 200 mm

Reflector | Downlights & Spots

LED REFLECTOR DOWNLIGHT COB | 10/20/30W BLACK



Input voltage: 220-240V
Power: 10/20/30 Watt
Driver: External driver (Non-dimmable) included
Dimmable: Optional
UGR: <19
Beam angle: 60°
IP rate: IP20
Mounting: Recessed
Cable length: 120 cm
Connection type: Europlug
Housing frame: Glass/Aluminium (black coated)



Universal Plug, Art. nr. 595-033



ART. NR.	POWER	LUMINOUS FLUX	LIGHT COLOR	COLOR TEMP.	DIAMETER	HEIGHT	MOUNTING HOLE
136-275	10W	1122 Lm	3000K	● Warm white	Ø 190 mm	75 mm	Ø 160 mm
136-278	10W	1218 Lm	4000K	○ Natural white	Ø 190 mm	75 mm	Ø 160 mm
136-276	20W	2126 Lm	3000K	● Warm white	Ø 190 mm	75 mm	Ø 160 mm
136-279	20W	2342 Lm	4000K	○ Natural white	Ø 190 mm	75 mm	Ø 160 mm
136-277	30W	3115 Lm	3000K	● Warm white	Ø 190 mm	75 mm	Ø 160 mm
136-280	30W	3458 Lm	4000K	○ Natural white	Ø 190 mm	75 mm	Ø 160 mm

DIMMABLE DRIVERS

POWER	TRIAC	1-10V	DALI
10W	215-205	215-517	215-266
20W	215-206	215-517	215-266
30W	215-282	215-509	215-265

Downlights & Spots | Reflector

LED REFLECTOR DOWNLIGHT | TRI-WHITE 8/10/20/30W | BLACK



With CCT switch for pre-settable color temperature 3000K - 4000K - 5700K

- Input voltage:** 230V
- Power:** 10/20/30 Watt
- Driver:** External driver (Non-dimmable) included
- Dimmable:** Optional
- UGR:** <19
- Beam angle:** 60°
- IP rate:** IP54 (when mounted)
- Mounting:** Recessed
- Cable length:** 120 cm
- Connection type:** Europlug
- Housing frame:** PC/Aluminium (black coated)



ART. NR.	POWER	LUMINOUS FLUX	LIGHT COLOR	DIAMETER	HEIGHT	MOUNTING HOLE
136-415	8W	540-625-570 Lm	Tri-white	Ø 95 mm	55 mm	Ø 82-88 mm
136-416	10W	640-760-670 Lm	Tri-white	Ø 108 mm	55 mm	Ø 90-95 mm
136-417	10W	900-1000-900 Lm	Tri-white	Ø 145 mm	77 mm	Ø 125-135 mm
136-418	20W	1800-2000-1800 Lm	Tri-white	Ø 145 mm	77 mm	Ø 125-135 mm
136-419	10W	960-1030-950 Lm	Tri-white	Ø 172 mm	90 mm	Ø 150-165 mm
136-420	20W	1920-2060-1900 Lm	Tri-white	Ø 172 mm	90 mm	Ø 150-165 mm
136-421	10W	950-1050-1030 Lm	Tri-white	Ø 228 mm	107 mm	Ø 200-210 mm
136-422	20W	1900-2100-2060 Lm	Tri-white	Ø 228 mm	107 mm	Ø 200-210 mm
136-423	30W	2680-3060-2940 Lm	Tri-white	Ø 228 mm	107 mm	Ø 200-210 mm
136-424	10W	960-1080-1040 Lm	Tri-white	Ø 280 mm	123 mm	Ø 230-260 mm
136-425	20W	1920-2160-2080 Lm	Tri-white	Ø 280 mm	123 mm	Ø 230-260 mm
136-426	30W	2880-3240-3120 Lm	Tri-white	Ø 280 mm	123 mm	Ø 230-260 mm

Reflector | Downlights & Spots

LED REFLECTOR DOWNLIGHT | TRI-WHITE 8/10/20/30W | WHITE



With CCT switch for pre-settable color temperature 3000K - 4000K - 5700K

- Input voltage:** 220-240V
- Power:** 10/20/30 Watt
- Driver:** External driver (Non-dimmable) included
- Dimmable:** Optional
- UGR:** <19
- Beam angle:** 60°
- IP rate:** IP54 (when mounted)
- Mounting:** Recessed
- Cable length:** 120 cm
- Connection type:** Europlug
- Housing frame:** PC/Aluminium (white coated)



ART. NR.	POWER	LUMINOUS FLUX	LIGHT COLOR	DIAMETER	HEIGHT	MOUNTING HOLE
136-427	8W	540-625-570 Lm	Tri-white	Ø 95 mm	55 mm	Ø 82-88 mm
136-428	10W	640-760-670 Lm	Tri-white	Ø 108 mm	55 mm	Ø 90-95 mm
136-429	10W	900-1000-900 Lm	Tri-white	Ø 145 mm	77 mm	Ø 125-135 mm
136-430	20W	1800-2000-1800 Lm	Tri-white	Ø 145 mm	77 mm	Ø 125-135 mm
136-431	10W	960-1030-950 Lm	Tri-white	Ø 172 mm	90 mm	Ø 150-165 mm
136-432	20W	1920-2060-1900 Lm	Tri-white	Ø 172 mm	90 mm	Ø 150-165 mm
136-433	10W	950-1050-1030 Lm	Tri-white	Ø 228 mm	107 mm	Ø 200-210 mm
136-434	20W	1900-2100-2060 Lm	Tri-white	Ø 228 mm	107 mm	Ø 200-210 mm
136-435	30W	2680-3060-2940 Lm	Tri-white	Ø 228 mm	107 mm	Ø 200-210 mm
136-436	10W	960-1080-1040 Lm	Tri-white	Ø 280 mm	123 mm	Ø 230-260 mm
136-437	20W	1920-2160-2080 Lm	Tri-white	Ø 280 mm	123 mm	Ø 230-260 mm
136-438	30W	2880-3240-3120 Lm	Tri-white	Ø 280 mm	123 mm	Ø 230-260 mm

DIMMABLE DRIVERS

POWER	TRIAC	1-10V	DALI
8 W	215-205	215-517	215-266
10W	215-205	215-517	215-266
20W	215-206	215-517	215-266
30W	215-282	215-509	215-265

Downlights & Spots | Reflector

REFLECTOR DOWNLIGHT ECO | TRI-WHITE

With CCT switch for pre-settable color temperature 3000K - 4000K - 6000K



Input voltage: 220-240V
Power: 10/15/20/28 Watt
Driver: External driver (non dimmable) included
Dimmable: Optional
UGR: <19
Beam angle: 50°
IP rate: IP20
Mounting: Recessed
Cable length: 120 cm
Connection type: Europlug
Housing frame: PC/Aluminium (white coated)



ART. NR.	POWER	LUMINOUS FLUX	LIGHT COLOR	DIAMETER	HEIGHT	MOUNTING HOLE
136-112	10W	1000 Lm	Tri-white	Ø 113 mm	65,5 mm	Ø 90 mm
136-115	15W	1500 Lm	Tri-white	Ø 145 mm	81,8 mm	Ø 120 mm
136-118	20W	2000 Lm	Tri-white	Ø 174 mm	90 mm	Ø 145 mm
136-121	28W	2800 Lm	Tri-white	Ø 232 mm	118 mm	Ø 195 mm

DIMMABLE DRIVERS

POWER	TRIAC	1-10V	DALI
10W	215-380	215-517	215-266
15W	215-280	215-517	215-267
20W	215-281	215-517	215-267
28W	215-282	215-509	215-265

Reflector | Downlights & Spots

REFLECTOR DOWNLIGHT ECO | TRI-WHITE

With CCT switch for pre-settable color temperature 3000K - 4000K - 6000K



Input voltage: 220-240V
Power: 10/15/20/28 Watt
Driver: External driver (non dimmable) included
Dimmable: Optional
UGR: <19
Beam angle: 50°
IP rate: IP20
Mounting: Recessed
Cable length: 120 cm
Connection type: Europlug
Housing frame: PC/Aluminium (Black coated)



ART. NR.	POWER	LUMINOUS FLUX	LIGHT COLOR	DIAMETER	HEIGHT	MOUNTING HOLE
136-195	10W	1000 Lm	Tri-white	Ø 113 mm	65,5 mm	Ø 90 mm
136-196	15W	1500 Lm	Tri-white	Ø 145 mm	81,8 mm	Ø 120 mm
136-197	20W	2000 Lm	Tri-white	Ø 174 mm	90 mm	Ø 145 mm
136-198	28W	2800 Lm	Tri-white	Ø 232 mm	118 mm	Ø 195 mm

DIMMABLE DRIVERS

POWER	TRIAC	1-10V	DALI
10W	215-380	215-517	215-266
15W	215-280	215-517	215-267
20W	215-281	215-517	215-267
28W	215-282	215-509	215-265



Toilet area with Black Reflector Spot 3000K art.nr 136-103, van Tienen Zeeland - The Netherlands

Downlights & Spots

DOWNLIGHT SPOT | DIMMABLE | WHITE

The newest generation in LED Downlights



Input voltage: 220-240V
Power: 6/9 Watt
Driver: Internal dimmable driver included
Dimming method: Triac
UGR: <17
Beam angle: 40°
IP rate: IP44 (When mounted)
Mounting: Recessed
Connection type: Terminal block
Housing frame: Aluminium (thermal coated)
Housing color: White



ART. NR.	POWER	LUMINOUS FLUX	COLOR TEMP.	LIGHT COLOR	DIAMETER	HEIGHT	MOUNTING HOLE
136-176	6W	370 Lm	2200K	● Warm white++	Ø 81 mm	87,7 mm	Ø 68 mm
136-177	6W	440 Lm	2700K	● Warm white+	Ø 81 mm	87,7 mm	Ø 68 mm
136-101	6W	470 Lm	3000K	● Warm white	Ø 81 mm	87,7 mm	Ø 68 mm
136-102	6W	480 Lm	4000K	○ Natural white	Ø 81 mm	87,7 mm	Ø 68 mm
136-190	9W	580 Lm	2700K	● Warm white+	Ø 103 mm	90,7 mm	Ø 90 mm
136-105	9W	600 Lm	3000K	● Warm white	Ø 103 mm	90,7 mm	Ø 90 mm
136-106	9W	650 Lm	4000K	○ Natural white	Ø 103 mm	90,7 mm	Ø 90 mm

DOWNLIGHT SPOT | DIMMABLE | BLACK

The newest generation in LED Downlights



Input voltage: 220-240V
Power: 6/9 Watt
Driver: Internal dimmable driver included
Dimming method: Triac
UGR: <17
Beam angle: 40°
IP rate: IP44 (When mounted)
Mounting: Recessed
Connection type: Terminal block
Housing frame: Aluminium (thermal coated)
Housing color: Black



ART. NR.	POWER	LUMINOUS FLUX	COLOR TEMP.	LIGHT COLOR	DIAMETER	HEIGHT	MOUNTING HOLE
136-178	6W	300 Lm	2200K	● Warm white++	Ø 81 mm	87,7 mm	Ø 68 mm
136-179	6W	370 Lm	2700K	● Warm white+	Ø 81 mm	87,7 mm	Ø 68 mm
136-103	6W	400 Lm	3000K	● Warm white	Ø 81 mm	87,7 mm	Ø 68 mm
136-104	6W	480 Lm	4000K	○ Natural white	Ø 81 mm	87,7 mm	Ø 68 mm
136-191	9W	460 Lm	2700K	● Warm white+	Ø 103 mm	90,7 mm	Ø 90 mm
136-107	9W	500 Lm	3000K	● Warm white	Ø 103 mm	90,7 mm	Ø 90 mm
136-108	9W	500 Lm	4000K	○ Natural white	Ø 103 mm	90,7 mm	Ø 90 mm

TRIAC LED DIMMERS

ART. NR.	POWER
215-131	2W - 350W
215-135	2X 2W - 100W

Downlights & Spots | Reflector

DOWNLIGHT ADJUSTABLE | ROUND



Input voltage: 220-240V
Power: 10/20/30 Watt
Driver: External driver (non dimmable) included
Dimmable: Optional
UGR: <19
Beam angle: 24°/45°
IP rate: IP20
Mounting: Recessed
Cable length: 200 cm
Connection type: Europlug
Housing frame: Aluminium/Glass (white coated)



ART.NR.	POWER	LUMINOUS FLUX	COLOR TEMP.(CCT)	LIGHT COLOR	BEAM ANGLE	DIAMETER	HEIGHT	MOUNTING HOLE
136-078	10W	750 Lm	3000K	○ Warm white	24°	Ø 96 mm	68 mm	Ø 85 mm
136-079	10W	800 Lm	4000K	○ Natural white	24°	Ø 96 mm	68 mm	Ø 85 mm
136-080	10W	975 Lm	3000K	○ Warm white	24°	Ø 145 mm	102 mm	Ø 120 mm
136-081	10W	1020 Lm	4000K	○ Natural white	24°	Ø 145 mm	102 mm	Ø 120 mm
136-082	20W	1950 Lm	3000K	○ Warm white	24°	Ø 145 mm	102 mm	Ø 120 mm
136-083	20W	2040 Lm	4000K	○ Natural white	24°	Ø 145 mm	102 mm	Ø 120 mm
136-084	10W	1020 Lm	3000K	○ Warm white	45°	Ø 180 mm	128,5 mm	Ø 165 mm
136-085	10W	1085 Lm	4000K	○ Natural white	45°	Ø 180 mm	128,5 mm	Ø 165 mm
136-086	20W	2040 Lm	3000K	○ Warm white	45°	Ø 180 mm	128,5 mm	Ø 165 mm
136-087	20W	2171 Lm	4000K	○ Natural white	45°	Ø 180 mm	128,5 mm	Ø 165 mm
136-088	30W	3060 Lm	3000K	○ Warm white	45°	Ø 180 mm	128,5 mm	Ø 165 mm
136-089	30W	3257 Lm	4000K	○ Natural white	45°	Ø 180 mm	128,5 mm	Ø 165 mm

DIMMABLE DRIVERS

POWER	TRIAC	1-10V	DALI
10W	215-205	215-517	215-266
20W	215-206	215-517	215-266
30W	215-282	215-509	215-265

Reflector | Downlights & Spots

DOWNLIGHT 42 WATT | ADJUSTABLE | 90°X70° | 3000K



Xitanium LED Driver

Input voltage: 220-240V
Power: 42W
Driver: External Philips Xitanium driver included
Dimmable: No
UGR: <19
Beam angle: 90°x70°
IP rate: IP20
Mounting: Recessed
Connection type:
Stripped wire
Housing frame: Aluminium/Glass (white coated)



ART.NR.	POWER	LUMINOUS FLUX	COLOR TEMP.(CCT)	LIGHT COLOR	BEAM ANGLE	SIZE	HEIGHT	MOUNTING HOLE
136-075	42W	3780 Lm	3000K	○ Warm white	90° x 70°	150 x 240 mm	113 mm	145 x 235 mm

Downlights with Casambi?

Casambi is an advanced system based on Bluetooth. Ideal for a dynamic offices and co-working spaces, enabling users to control their own lighting or have it controlled automatically with the Casambi app. Energy and cost saving!

CONTROLLING

- **Downlights with internal dimmable driver** use Casambi receiver Art.nr 214-206 (max 150W)
- **Downlights with external driver** replace driver with Art.nr 215-295 (max 20 Watt) or Art.nr 215-296 (max 36 Watt)

Interested to find out more about Casambi or see the entire Casambi range? Check our Tronix catalog 'Light design & technique'

CASAMBI

Downlights Casambi aansturen?

Casambi is een geavanceerd systeem op basis van Bluetooth. Ideaal voor een dynamisch kantoor of verzamelgebouw, omdat het gebruikers de mogelijkheid geeft om de verlichting voor hun eigen ruimte zelf in te stellen, of deze automatisch te laten aansturen. Energie- en kostenbesparend!

AANSTURING

- **Downlights met interne dimbare driver** gebruik Casambi ontvanger Art.nr 214-206 (max 150W)
- **Downlights met externe driver** vervang driver met Art.nr 215-295 (max 20 Watt) of Art.nr 215-296 (max 36 Watt)

Meer weten over Casambi of het gehele Casambi assortiment zien? Check dan onze Tronix catalogus 'Light design & technique'

2 Panels

Setting quality standards for
functional lighting in work spaces





Panels | 60x60

LED PANEL 60X60 CM | >100 LM/W WHITE FRAME

LED panels with 100 Lm/W performance in 3000K, 4000K and 6000K



- Input voltage:** 220-240V
- Power:** 36 Watt
- Luminous flux:** 3600 Lm
- Luminous efficiency:** >100 Lm/W
- Driver:** External flicker free driver included
- Beam angle:** 120° / 90° UGR<19
- IP rate:** IP20
- Length:** 595 mm
- Width:** 595 mm
- Height:** 11 mm
- Cable length:** 200 cm
- Connection type:** Europlug
- Housing frame:** Aluminium (white coated)



PANEL 60X60 | WARM WHITE 3000K | 3600 LM



ART. NR.	DIMMABLE	UGR
174-140	Non-dimmable	-
174-176	Triac	-
174-177	1-10V	-
174-178	Dali	-
174-156	Non-dimmable	UGR<19
174-191	Triac	UGR<19
174-192	1-10V	UGR<19
174-193	Dali	UGR<19

PANEL 60X60 | NATURAL WHITE 4000K | 3600 LM



ART. NR.	DIMMABLE	UGR
174-141	Non-dimmable	-
174-182	Triac	-
174-183	1-10V	-
174-184	Dali	-
174-155	Non-dimmable	UGR<19
174-188	Triac	UGR<19
174-189	1-10V	UGR<19
174-190	Dali	UGR<19

PANEL 60X60 | COLD WHITE 6000K | 3600 LM



ART. NR.	DIMMABLE	UGR
174-130	Non-dimmable	-
174-185	Triac	-
174-186	1-10V	-
174-187	Dali	-
174-233	Non-dimmable	UGR<19
174-234	Triac	UGR<19
174-235	1-10V	UGR<19
174-236	Dali	UGR<19

LED PANEL 60X60 CM | HIGH EFFICIENCY >130 LM/W | WHITE FRAME

LED panel with high Lm/W performance in 3000K or 4000K



- Input voltage:** 220-240V
- Power:** 27 Watt
- Luminous flux:** 3510 Lm
- Luminous efficiency:** >130 Lm/W
- Driver:** External flicker free driver included (non dimmable)
- Dimmable:** Optional, check our website for optional dimmable drivers
- Beam angle:** 120° / 90° UGR<19
- IP rate:** IP20
- Length:** 595 mm
- Width:** 595 mm
- Height:** 11 mm
- Cable length:** 200 cm
- Connection type:** Europlug
- Housing frame:** Aluminium (white coated)



PANEL 60X60 | WARM WHITE 3000K | 3510 LM



ART. NR.	DIMMABLE	UGR
174-740	Non-dimmable	-
174-756	Non-dimmable	UGR<19

PANEL 60X60 | NATURAL WHITE 4000K | 3510 LM



ART. NR.	DIMMABLE	UGR
174-741	Non-dimmable	-
174-755	Non-dimmable	UGR<19

30x120 | Panels

LED PANEL 30X120 CM | >100 LM/W WHITE FRAME



LED panels with Lm/W performance in 3000K, 4000K and 6000K

- Input voltage:** 220-240V
- Power:** 36 Watt
- Luminous flux:** 3600 Lm
- Luminous efficiency:** >100 Lm/W
- Driver:** External flicker free driver included.
- Beam angle:** 120° / 90° UGR<19
- IP rate:** IP20
- Length:** 1195 mm
- Width:** 295 mm
- Height:** 11 mm
- Cable length:** 200 cm
- Connection type:** Europlug
- Housing frame:** Aluminium (white coated)



PANEL 30X120 | WARM WHITE 3000K | 3600 LM



ART. NR.	DIMMABLE	UGR
174-131	Non-dimmable	-
174-208	Triac	-
174-209	1-10V	-
174-210	Dali	-
174-222	Non-dimmable	UGR<19
174-226	Triac	UGR<19
174-227	1-10V	UGR<19
174-228	Dali	UGR<19

PANEL 30X120 | NATURAL WHITE 4000K | 3600 LM



ART. NR.	DIMMABLE	UGR
174-154	Non-dimmable	-
174-197	Triac	-
174-198	1-10V	-
174-199	Dali	-
174-221	Non-dimmable	UGR<19
174-223	Triac	UGR<19
174-224	1-10V	UGR<19
174-225	Dali	UGR<19

PANEL 30X120 | COLD WHITE 6000K | 3600 LM



ART. NR.	DIMMABLE	UGR
174-132	Non-dimmable	-
174-194	Triac	-
174-195	1-10V	-
174-196	Dali	-
174-229	Non-dimmable	UGR<19
174-230	Triac	UGR<19
174-231	1-10V	UGR<19
174-232	Dali	UGR<19

LED PANEL 30X120 CM | HIGH EFFICIENCY >130 LM/W | WHITE FRAME



LED panel with high Lm/W performance in 3000K or 4000K

- Input voltage:** 220-240V
- Power:** 27 Watt
- Luminous flux:** 3510 Lm
- Luminous efficiency:** >130 Lm/W
- Driver:** External flicker free driver included (non dimmable).
- Dimmable:** Optional (check our website)
- Beam angle:** 120° / 90° UGR<19
- IP rate:** IP20
- Length:** 1195 mm
- Width:** 295 mm
- Height:** 11 mm
- Cable length:** 200 cm
- Connection type:** Europlug
- Housing frame:** Aluminium (white coated)



PANEL 30X120 | WARM WHITE 3000K | 3510 LM



ART. NR.	DIMMABLE	UGR
174-731	Non-dimmable	-
174-822	Non-dimmable	UGR<19

PANEL 30X120 | NATURAL WHITE 4000K | 3510 LM



ART. NR.	DIMMABLE	UGR
174-754	Non-dimmable	-
174-821	Non-dimmable	UGR<19

Panels | 60x60 | Specials

LED PANEL 60X60 CM | TRI-WHITE | >100 LM/W

With CCT switch for pre-settable color temperature 3000K - 4000K - 6000K



- Input voltage:** 220-240V
- Power:** 40 Watt
- Luminous flux:** 4000 Lm
- Luminous efficiency:** >100 Lm/W
- Driver:** External flicker free driver included (non dimmable).
- Dimmable:** Optional, check our website for optional dimmable drivers
- Beam angle:** 90°/120°
- Length:** 595 mm
- Width:** 595 mm
- Height:** 11 mm
- IP rate:** IP20
- Cable length:** 200 cm
- Connection type:** Europlug
- Housing frame:** Aluminium (white coated)

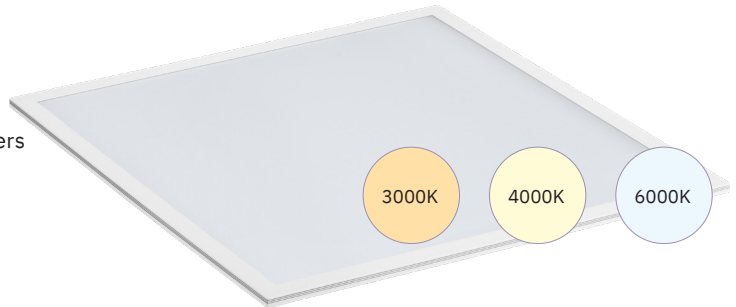

ART.NR.	POWER	LUMINOUS FLUX	LIGHT COLOR	UGR	CRI	BEAM ANGLE
174-240	40 Watt	4000 Lm	Tri-white	-	CRI>80	120°
174-242	40 Watt	4000 Lm	Tri-white	UGR <19	CRI>90	90°

LED PANEL 60X60 CM | 34W | RGBW

Controllable LED panel RGBW, RGBW controller not included (Art.nr. 214-143)



- Input voltage:** 24V
- Power:** 34 Watt
- Driver:** Not included
- Dimmable:** Yes
- Beam angle:** 120°
- Length:** 595 mm
- Width:** 595 mm
- Height:** 11 mm
- IP rate:** IP20
- Cable length:** 200 cm
- Connection type:** Stripped wire
- Housing frame:** Aluminium (white coated)

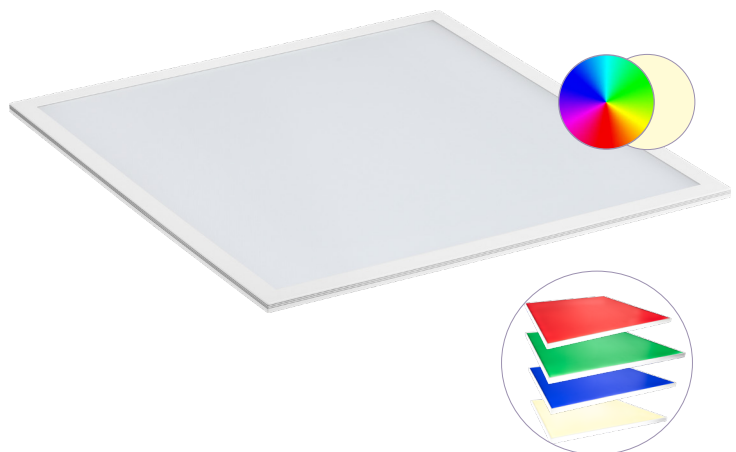

ART. NR.	POWER	LIGHT COLOR	COLOR TEMP. (CCT)
174-048	34 Watt	RGBW	RGB + 3000K

ART. NR.	CONTROLLER/RECEIVER*
214-142	RGB+W Remote control RF 2 Zones 10 Scenes
214-143	RF RGB(W) or TW Controller 12V ~ 36V 4*5A



Specials | 30x120 | Panels

LED PANEL 30X120 CM | TRI-WHITE | >100 LM/W

With CCT switch for pre-settable color temperature 3000K/4000K /6000K



Input voltage: 220-240V

Power: 40 Watt

Luminous flux: 4000 Lm

Luminous efficiency: >100 Lm/W

Driver: External flicker free driver included (non dimmable).

Dimmable: Optional, check our website for optional dimmable drivers

Light color: Tri-White

Beam angle: 120°

IP rate: IP20

Length: 1195 mm

Width: 295 mm

Height: 11 mm

Cable length: 200 cm

Connection type: Europlug

Housing frame: Aluminium (white coated)

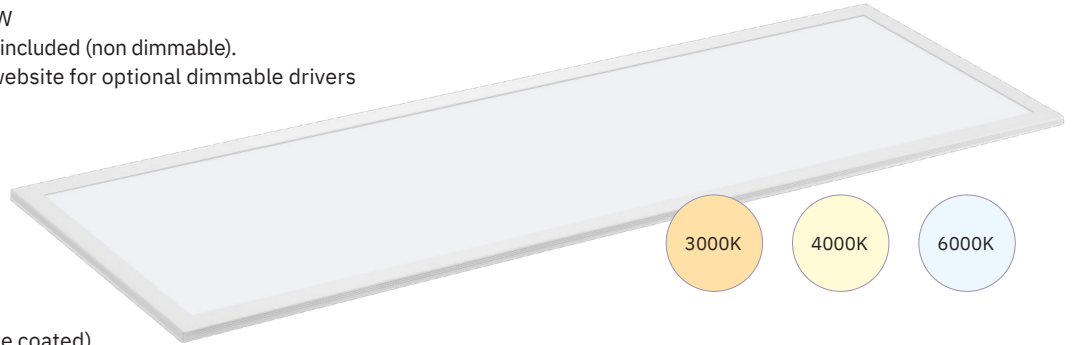

ART.NR.	POWER	LUMINOUS FLUX	LIGHT COLOR
174-241	40 Watt	4000 Lm	Tri-white

Energy investment allowance (EIA)

LED lighting fixtures with an integrated, non-changeable LED light source that meets the lifespan criteria L90B50 at 50.000 hours and must be measured in accordance with LM-80.

All >130 Lm/Watt High Efficiency Panels are qualified for Energy Investment Allowance (EIA) for Dutch businesses. So if you have a company in the Netherlands and invest in energy-efficient technologies or assets, you may be eligible to apply for this allowance and benefit from it. In that case, 45% of the costs are deductible from the taxable profit.

*LM-80 files available online

Energie investeringsaftrek (EIA)

LED verlichtingsarmaturen met een geïntegreerde, niet uitwisselbare LED-lichtbron, die voldoen aan de levensduurcriteria L90B50 bij 50.000 uur en dienen gemeten te zijn conform LM-80.

Alle Tronix >130 Lm/W High Efficiency LED Panels voldoen aan de eisen die anno 2022 worden gesteld om voor de Energie investeringsaftrek (EIA) regeling in aanmerking te komen*. Investeert u als bedrijf in energiezuinige technieken en duurzame energie? Maak dan gebruik van deze regeling, want 45,5% van de investeringskosten is in dat geval aftrekbaar van de fiscale winst.

*LM-80 rapporten online beschikbaar



Panels | specials

LED PANEL 60x60 / 30X120 CM | TUNABLE WHITE >100 LM/W

Tunable white 2700K - 6000K LED Panel, Power supply not included.



Constant current: 1050 mA
Power: 36 Watt
Luminous flux: >3600 Lm
Luminous efficiency: >100 Lm/W
Driver: Not included (Art.nr. 214-167)
Dimmable: Yes
Beam angle: 90°
IP rate: IP20
Length: 595 | 1195 mm
Width: 595 | 295 mm
Height: 11 mm

Cable length: 50 cm
Connection type: Stripped wire
Housing frame: Aluminium (white coated)



ART. NR.	SIZE	POWER	LUMINOUS FLUX	COLOR TEMP. (CCT)
174-250	60x60 cm	36 Watt	>3600 Lm	2700K - 6000K
174-255	30x120 cm	36 Watt	>3600 Lm	2700K - 6000K

DESK REMOTE FOR TUNABLE WHITE



- 1. Decrease light intensity from 100% to 1%
- 2. Change color temperature from 2700K~6000K
- 1. Increase light intensity from 1% to 100%
- 2. Change color temperature from 6000K~2700K

REMOTE WALL CONTROLLER FOR TUNABLE WHITE



ART. NR.	214-159
OUTPUT	RF Signal
IP RATE	IP20
SIZE	96 x 65 x 74 mm
CONTROL RANGE	CCT & Brightness <20 meter

ART. NR.	214-172
OUTPUT	RF Signal
IP RATE	IP20
SIZE	86 x 86 x 14 mm
CONTROL RANGE	CCT & Brightness <20 meter

50 WATT RF 2 CHANNELS LED DRIVER

Constant current adjustable



ART. NR.	214-167
INPUT VOLTAGE	200-240V
OUTPUT	250-1500 mA (Adjustable)
POWER FACTOR	>0.9
POWER	50 Watt
SIZE	210 x 50 x 32 mm

REMOTE CONTROL FOR TUNABLE WHITE



ART. NR.	214-175
DIMMING	Color wheel
SIZE	120 x 55 x 17 mm
BATTERY	Included
RANGE	<20 meter
ZONES	4

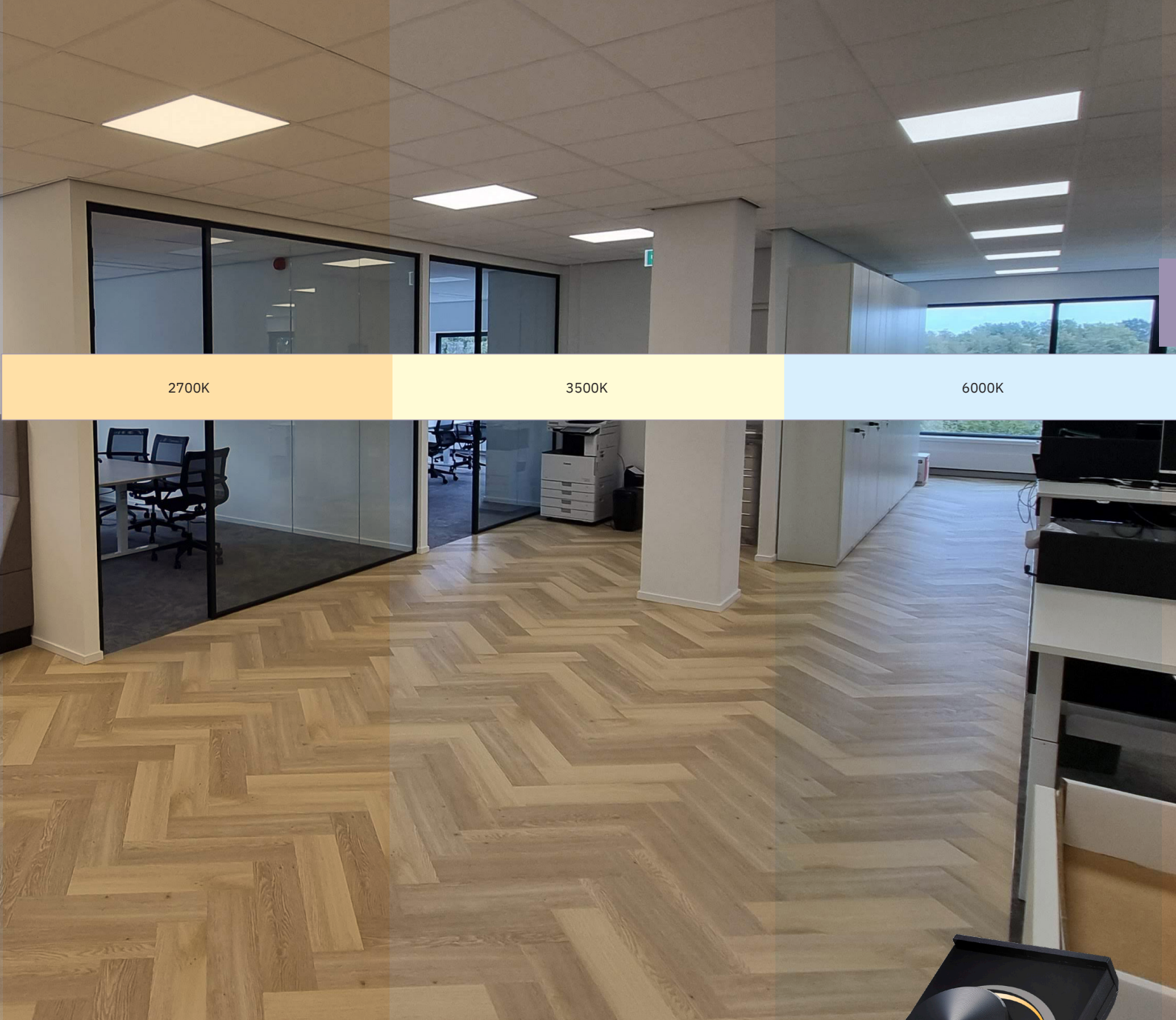

2700K

3500K

6000K

Tronix Tunable White LED Panels 2700K-6000K

Create a natural course of light in your building with Tronix Tunable White LED Panels, that are completely adjustable in both light intensity and color tone. With the matching controller, not only the amount of light is completely adjustable, but on top of that possible to choose from a complete color range, varying from 2700K (warm light) to 6000K (cold light).

With these special panels you can create a more natural course of light: from dimmed warm light in the morning, to a higher light intensity with cooler light around noon, and then slowly getting back again to a lower light level with warm white light.

Tronix Tunable Witte LED Panelen 2700K-6000K

Creëer een natuurlijk lichtverloop in elke ruimte met de Tunable White LED Panelen van Tronix, die volledig instelbaar zijn op lichtintensiteit en kleur. Met de bijpassende controller kan niet alleen de hoeveelheid licht heel eenvoudig worden aangepast, maar is het ook mogelijk om een complete kleurenrange van 2700K (warm licht) tot en met 6000K (koud licht) zelf in te stellen.

Hiermee wordt het mogelijk om een natuurlijker lichtverloop te creëren: van gedimd warm licht in de ochtend, naar een hogere lichtsterkte met koeler licht rond het middaguur, om aan het eind van middag weer langzaam terug te gaan naar een lager lichtniveau met warm wit licht.





Conference room with Tronix LED Panels Tri-white UGR <17
Art.nr 174-270, van Tienen Zeeland - The Netherlands

LED PANEL | 60X60 CM | TRI-WHITE | 130 Lm/W | UGR<17



LED panel with CCT switch for pre-settable color temperature 3000K, 4000K or 5700K
Choice in black or white frame. Also available in Tunable white. Ask us for more information.



- Input voltage:** 220-240V
- Power:** 27 Watt
- Luminous flux:** >3510 Lm
- Luminous efficiency:** >130 Lm/W
- Driver:** External flicker free driver included (non dimmable)
- Dimmable:** Optional, check our website for dimmable drivers
- Beam angle:** 70°
- IP rate:** IP20
- Length:** 595 mm
- Width:** 595 mm
- Height:** 16 mm
- Cable length:** 200 cm
- Connection type:** Europlug
- Housing frame:** Aluminium (coated)

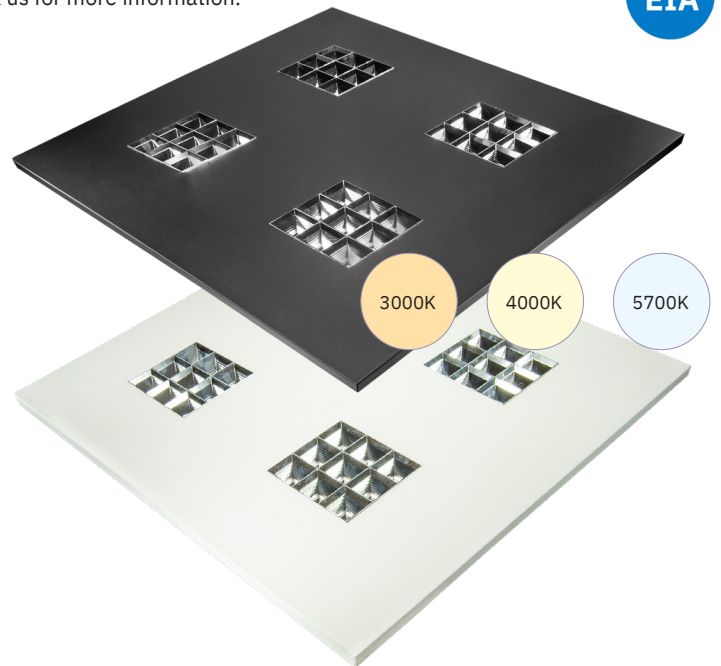

ART. NR.	FRAME COLOR
174-271	● Black frame
174-270	○ White frame

LED PANEL | BUTTERFLY | TRI-WHITE | UGR<19



LED panel with CCT switch for pre-settable color temperature
3000K, 4000K or 5700K

- Input voltage:** 220-240V
- Power:** 36 Watt
- Luminous flux:** 3000~3600 Lm
- Luminous efficiency:** >100 Lm/W
- Driver:** External flicker free driver included
- Dimmable:** Yes, Triac
- Beam angle:** 90°
- IP rate:** IP20
- Length:** 595 mm / 1195 mm
- Width:** 595 mm / 295 mm
- Height:** 49 mm
- Cable length:** 200 cm
- Connection type:** Europlug
- Housing frame:** Aluminium (coated)

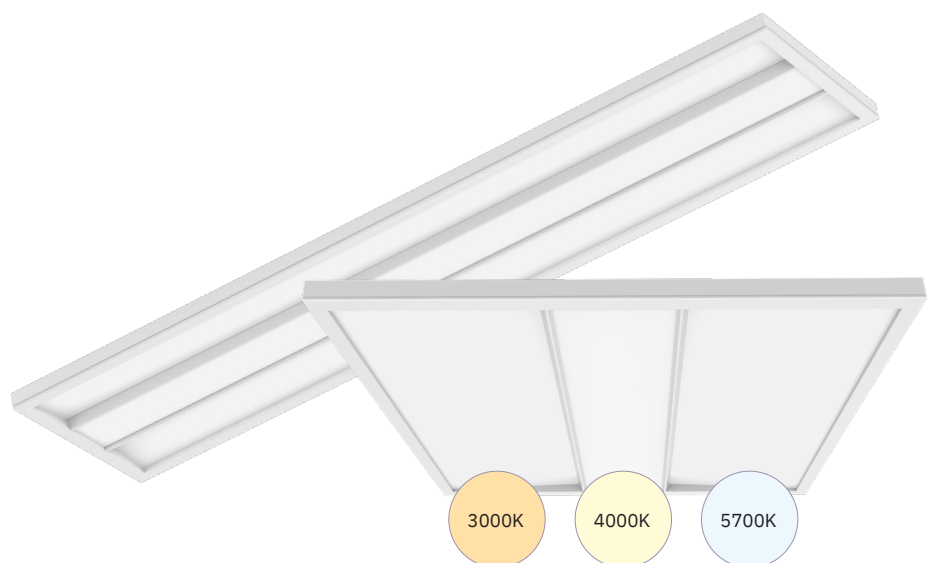

ART. NR.	LENGTH	WIDTH	HEIGHT
174-275	595 mm	595 mm	49 mm
174-276	1195 mm	295 mm	49 mm

Panels | Round

PANEL ROUND Ø 61 CM | CRI>90 | >100 LM/W WHITE FRAME

LED panels 100 Lm/W performance in 4000K or 3000K with white frame.



- Input voltage:** 240V
- Power:** 40 Watt
- Luminous flux:** 4000 Lm
- Luminous efficiency:** >100 Lm/W
- Driver:** External flicker free driver included.
- Beam angle:** 90°
- IP rate:** IP20
- UGR:** <19
- CRI:** >90
- Diameter:** 610 mm
- Height:** 15 mm
- Connection type:** Terminal block
- Housing frame:** Aluminium (white coated)



PANEL Ø 61 | WARM WHITE 3000K | 4000 LM



ART. NR.	DIMMABLE	UGR
174-204	Non-dimmable	UGR<19
174-214	Triac	UGR<19
174-215	1-10V	UGR<19
174-216	Dali	UGR<19

PANEL Ø 61 | NATURAL WHITE 4000K | 4000 LM



ART. NR.	DIMMABLE	UGR
174-205	Non-dimmable	UGR<19
174-211	Triac	UGR<19
174-212	1-10V	UGR<19
174-213	Dali	UGR<19

Low UGR<19 value for minimal discomfort from glare and high productivity

A low UGR value (Unified Glare Rating) avoids unwanted glare, minimizing any discomfort caused by light in working spaces. The light must be clear enough to perform activities, but should at no time be causing unwanted brilliance or glare. Tronix UGR<19 Panels have a high scoring rate according to the guidelines as established by norm NEN-EN 12464-1. A low value represents a minimized glare-effect; the average value lies between 15 and 30.

Lage UGR<19 voor minder lichthinder en hoge productiviteit

Een lage UGR waarde (Unified Glare Rating) zorgt voor minder lichthinder in werkrumtes. Het licht moet helder genoeg zijn om de werkzaamheden te kunnen uitvoeren, maar mag niet zorgen voor schittering of verblinding. Tronix UGR<19 Panelen scoren zeer goed volgens de richtlijnen zoals deze zijn vastgesteld in de norm NEN-EN 12464-1. Een lage waarde staat voor weinig verblinding; de gemiddelde waarde ligt tussen 15 en 30.



LED PANEL 30X60 CM | TRI-WHITE | >100 LM/W

With CCT switch for pre-settable color temperature 3000K/4000K/6000K



- Input voltage:** 220-240V
- Power:** 18 Watt
- Luminous flux:** >1800 Lm
- Luminous efficiency:** >100 Lm/W
- Driver:** External flicker free driver included (non dimmable)
- Dimmable:** Optional, check our website for optional dimmable drivers
- Beam angle:** 120°
- IP rate:** IP20
- Length:** 595 mm
- Width:** 295 mm
- Height:** 11 mm
- Cable length:** 200 cm
- Connection type:** Europlug
- Housing frame:** Aluminium (white coated)

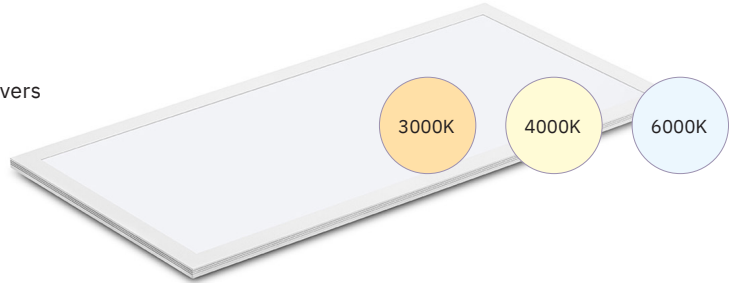

ART.NR.	POWER	LUMINOUS FLUX	LIGHT COLOR
174-029	18 Watt	>1800 Lm	Tri-white

LED PANEL 60X120 CM | TRI-WHITE | >100 LM/W

With CCT switch for pre-settable color temperature 3000K/4000K/6000K



- Input voltage:** 220-240V
- Power:** 48 Watt
- Luminous efficiency:** >100 Lm/W
- Driver:** External flicker free driver included (non dimmable)
- Dimmable:** Optional, check our website for optional dimmable drivers
- Beam angle:** 120°
- IP rate:** IP20
- Length:** 1195 mm
- Width:** 595 mm
- Height:** 11 mm
- Cable length:** 200 cm
- Connection type:** Europlug
- Housing frame:** Aluminium (white coated)

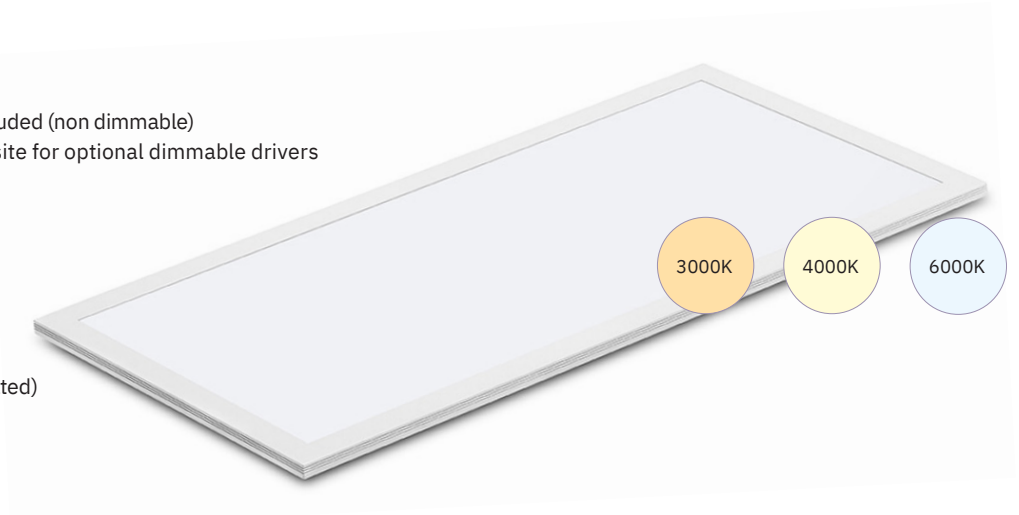

ART.NR.	POWER	LUMINOUS FLUX	LIGHT COLOR
174-237	48 Watt	>4800 Lm	Tri-white

Panels | Accessories

SURFACE MOUNTING KIT FOR PANEL | WHITE

ART. NR.	LENGTH	WIDTH	HEIGHT
174-101	600 mm	600 mm	40 mm
174-103	1200 mm	300 mm	40 mm
174-105	600 mm	300 mm	40 mm
174-106	1200 mm	600 mm	40 mm



SURFACE MOUNTING KIT FOR PANEL | BLACK

ART. NR.	LENGTH	WIDTH	HEIGHT
174-107	600 mm	600 mm	40 mm



SUSPENSION KIT FOR LED PANELS 174-100 & 174-200 SERIES | MAX. 150 CM

Suitable for 60x60 or 30x120 cm LED Panels 100 Lm/W 174-100 to 174-299

ART. NR.	WIRE QUANTITY	LED PANEL SIZE
174-050	4 pcs	All sizes

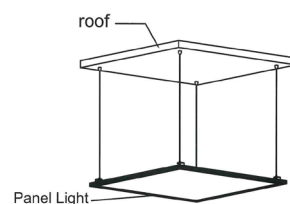

SUSPENSION KIT FOR LED PANELS | MAX. 200 CM

Suitable for all 60x60 or 30x120 cm LED Panels

ART. NR.	WIRE QUANTITY	LED PANEL SIZE
174-700	4 pcs	60x60
174-701	6 pcs	30x120

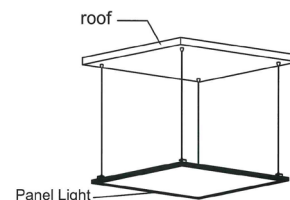

EASY SURFACE MOUNTING KIT

For 60*60 cm and 30*120 cm LED Panels (174-100 & 200 series)

ART. NR.	QUANTITY
174-058	4 pcs

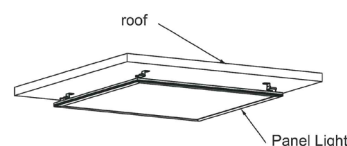

SPRING KIT FOR LED PANELS

For 60*60 cm and 30*120 cm Panels (174-100 & 200 series)

ART. NR.	QUANTITY
174-057	4 pcs

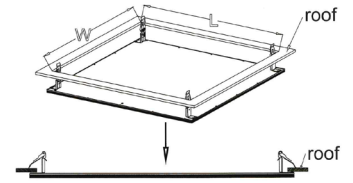

LED EMERGENCY PACK | 10-60V | 70mA | AUTO TEST

To convert LED panels, downlights or other ceiling lights into luminaires with an emergency function. See P.89 for more specs.

ART. NR.	SIZE	OPERATING TIME
600-028	145 x 36,8 x 23,5 mm	Min. 3 hrs.



IR MOTION SENSOR | CEILING | RECESSED | IP20

Recessed Infra-red motion sensor for suspended ceilings. Use 595-039 for easy connecting to Panels.

Input voltage: 220V -240V

Time delay: 10 sec. - 15 min. (adj.)

Detection motion speed: 0,6 - 1,5 m/sec

Installation Height: 2,2 - 4m

Size: Ø76 mm (mount. size Ø61,5x75,6 mm)

IP rate: IP20

Connection type: Terminal block



ART. NR.	DETECTION RADIUS	OPERATING TIME	DETECTION DISTANCE	AMBIENT LIGHT
214-051	360°	300 Watt	Max. 6 meter	3-2000 Lux (adj.)

GST18/3 ACCESSORIES



ART. NR.	CONNECTION TYPE
595-040	Plug Male
595-036	Powercable 3 meter
595-035	Extension cable 2 meter
595-037	Extension cable 3 meter
595-034	T-connector
595-030	Male to Female Schuko
595-033	Male to Female EU plug
595-039	Easy connecting sensor Stripped wire
595-038	With stripped wire 1 meter



595-040



595-036



595-035/595-037



595-034



595-030



595-033



595-039



595-038

3 Ceiling & Wall Lights

Large choice in lighting solutions
for walls and ceilings





Ceiling & Wall Lights | Ceiling Lights

CEILING LIGHT ROUND | TRI-WHITE | 12W/18W | IP54

With CCT switch for pre-settable color temperature 3000K - 4000K - 5700K



Input voltage: 230V
Power: 12W/18W
Dimmable: No/Yes
Beam angle: 120°
IP rate: IP54
Connection type: Terminal block
Material: PC



ART.NR.	POWER	LUMINOUS FLUX	LIGHT COLOR	DIAMETER	HEIGHT	DIMMABLE	MOTION SENSOR
136-042	12W	1200 Lm	Tri-white	Ø 300 mm	58 mm	No	No
136-040	18W	1850 Lm	Tri-white	Ø 300 mm	58 mm	Yes	No
136-041	18W	1850 Lm	Tri-white	Ø 300 mm	58 mm	No	Yes

CEILING LIGHT ROUND | TRI-WHITE | 15W | IP65

With CCT switch for pre-settable color temperature 3000K - 4000K - 5700K



Input voltage: 230V
Power: 15W
Dimmable: No
Beam angle: 110°
IP rate: IP65
Connection type: Terminal block
Material: PC (white)



ART.NR.	POWER	LUMINOUS FLUX	LIGHT COLOR	DIAMETER	HEIGHT	EMERGENCY
136-043	15W	1270-1420 Lm	Tri-white	Ø 300 mm	60 mm	No
136-044	15W	1270-1420 Lm	Tri-white	Ø 300 mm	60 mm	Yes

CEILING LIGHT ROUND | TRI-WHITE | 15W | IP65

With CCT switch for pre-settable color temperature 3000K - 4000K - 5700K



Input voltage: 230V
Power: 15W
Dimmable: No
Beam angle: 110°
IP rate: IP65
Connection type: Terminal block
Material: PC (black)



ART.NR.	POWER	LUMINOUS FLUX	LIGHT COLOR	DIAMETER	HEIGHT	EMERGENCY
136-045	15W	1270-1420 Lm	Tri-white	Ø 300 mm	60 mm	No
136-046	15W	1270-1420 Lm	Tri-white	Ø 300 mm	60 mm	Yes

Ceiling Lights | Ceiling & Wall Lights

CEILING LIGHT | TRI-WHITE | 12W | IP20

With CCT switch for pre-settable color temperature 3000K - 4000K - 5700K



Input voltage: 230V
Power: 12W
Dimmable: No
Beam angle: 120°
IP rate: IP20
Connection type: Terminal block
Housing material: Aluminium & PC



ART. NR.	POWER	LUMINOUS FLUX	LIGHT COLOR	DIAMETER	HEIGHT	MOTION SENSOR
136-002	12 Watt	924 Lm	Tri-white	Ø 280 mm	95 mm	No
136-003	12 Watt	924 Lm	Tri-white	Ø 280 mm	95 mm	Yes

CEILING DOWNLIGHT | TRI-WHITE | 12W/18W | IP44

This multifunctional ceiling lamp can be used for both recessed and surface mounting. In addition, it can be pre-set to power (12W / 18W) and light color (3000K / 4000K / 6000K).



Input voltage: 220-240V
Power: 12/18W (presettable)
Dimmable: No
Beam angle: 110°
IP rate: IP44
Connection type: Terminal block
Housing material: Aluminium & PC



ART. NR.	POWER	LUMINOUS FLUX	LIGHT COLOR	DIAMETER	HEIGHT	MOUNTING HOLE
136-221	12/18 Watt	900/1350 Lm	Tri-white	Ø 280 mm	20,5 mm	Ø 120-200 mm

VESTIBULE BULKHEAD | 4000K | 6,4W | IP65



Input voltage: 230V
Power: 6,4W
Dimmable: No
Beam angle: 120°
IP rate: IP65
Connection type: Terminal block
Housing material: PC



ART. NR.	POWER	LUMINOUS FLUX	COLOR TEMP.(CCT)	LIGHT COLOR	LENGTH	WIDTH	HEIGHT
136-024	6,4W	328 Lm	4000K	○ Natural white	345 mm	107 mm	75 mm

Ceiling & Wall Lights | Wall Lights

WALL LIGHT | 7W | IP65 | 2700K-3000K

With CCT switch for pre-settable color temperature 2700K-3000K



Input voltage: 220-240V
Power: 7W
Dimmable: No
Beam angle: 120°
IP rate: IP65
IK rate: IK08
Connection type: Terminal block
Material: PC/Aluminium



ART.NR.	POWER	LUMINOUS FLUX	COLOR TEMP. (CCT)	LIGHT COLOR	SIZE (L X W X H)	DIMMABLE	MOTION SENSOR
136-240	7W	700 Lm	2700K-3000K	☉ Warm white+ / warm white	251 x 167 x 80 mm	No	No
136-241	7W	700 Lm	2700K-3000K	☉ Warm white+ / warm white	251 x 167 x 80 mm	No	Yes

WALL LIGHT | 3W | IP65 | 2700K-3000K

With CCT switch for pre-settable color temperature 2700K-3000K



Input voltage: 220-240V
Power: 3W/6W
Dimmable: No
Beam angle: 120°
IP rate: IP65
IK rate: IK06
Connection type: Terminal block
Material: PC



ART.NR.	POWER	LUMINOUS FLUX	COLOR TEMP. (CCT)	LIGHT COLOR	SIZE	DIMMABLE	MOTION SENSOR
136-250	3W	700 Lm	2700K-3000K	☉ Warm white+ / warm white	Ø 125 mm	No	No
136-255	6W	700 Lm	2700K-3000K	☉ Warm white+ / warm white	Ø 160 mm	No	No



*Appartment hallway with surface mount
Wall Light, Art.nr. 136-042*

Ceiling & Wall Lights | Batten Lights

BATTEN LIGHT | 2 SIZES | 20W/40W | IP20 | TRI-WHITE

With CCT switch for pre-settable color temperature 3000K - 4000K - 5700K. Equipped with internal terminal block for wiring in and out.



Input voltage: 220-240V

Power: 20W/40W

Dimmable: No

Beam angle: 120°

IP rate: IP20

IK rate: IK08

Connection type: Terminal block

Housing material: Aluminium & PC



ART. NR.	POWER	LUMINOUS FLUX	LIGHT COLOR	LENGTH	WIDTH	HEIGHT
136-300	20 Watt	1800 - 2200 Lm	Tri-white	603 mm	71 mm	64 mm
136-301	40 Watt	4000 - 4600 Lm	Tri-white	1203 mm	71 mm	64 mm

BATTEN LIGHT | 600MM | 10~25W | IP20 | TRI-WHITE

With DIP switch for pre-settable power 10~25W and CCT switch for pre-settable color temperature 3000K - 4000K - 5700K. Equipped with internal terminal block for wiring in and out.



Input voltage: 220-240V

Power: 10W~25W

Dimmable: No

Beam angle: 120°

IP rate: IP20

IK rate: IK08

Connection type: Terminal block

Housing material: Aluminium & PC

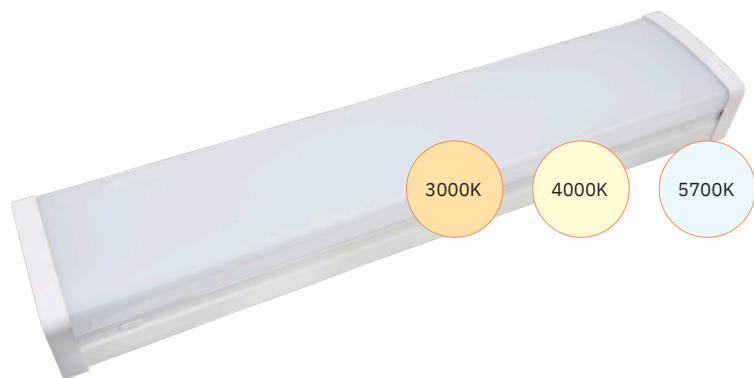

ART. NR.	POWER	LUMINOUS FLUX	LIGHT COLOR	LENGTH	WIDTH	HEIGHT
136-305	10~25 Watt	1050~2500 Lm	Tri-white	600 mm	124 mm	68 mm

Batten Lights | Ceiling & Wall Lights

LED T5 | SURFACE | 60/120 CM | TRI-WHITE

With CCT switch for pre-settable color temperature 3000K - 4000K - 5700K.
Easy connectable upto 750W



Input voltage: 200-240V

Power: 8W/18W

Dimmable: No

Beam angle: 160°

IP Rate: IP42

Connection Type: Male connector

Power cable: Excluding 177-068/177-069 (1x Power cable for max. 750W)

Housing material: PC white (RAL9001)

Accessories included: Mounting brackets for wall/ceiling, 1x connector

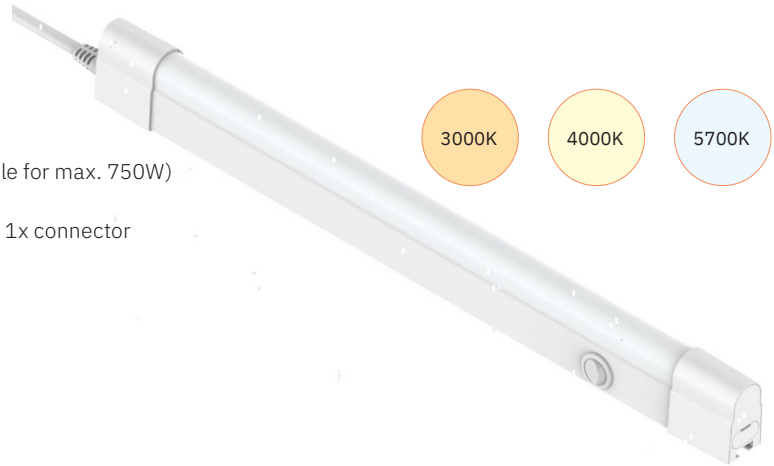

ART. NR.	POWER	LUMINOUS FLUX	LIGHT COLOR	LENGTH	WIDTH	HEIGHT
177-061	8 Watt	866-974-937 Lm	Tri-white	600 mm	22,3 mm	37,4 mm
177-062	18 Watt	1937-2203-2099 Lm	Tri-white	1200 mm	22,3 mm	37,4 mm

BATTEN LIGHT FLAT | 2 SIZES | 18W/30W | IP20 | TRI-WHITE

With CCT switch for pre-settable color temperature 3000K - 4000K - 5700K.



Input voltage: 200-240V

Power: 18W/30W

Dimmable: No

Beam angle: 120°

IP rate: IP20

IK rate: IK06

Connection type: Stripped wire

Power cable: 60 cm (on the back of the fixture)

Housing material: PC

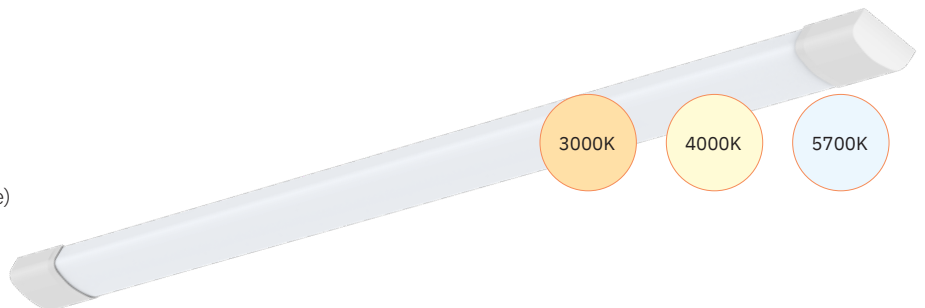

ART. NR.	POWER	LUMINOUS FLUX	LIGHT COLOR	LENGTH	WIDTH	HEIGHT
136-310	18 Watt	1450 - 1750 Lm	Tri-white	690 mm	56,5 mm	27,5 mm
136-311	30 Watt	3100 - 3400 Lm	Tri-white	1200 mm	56,5 mm	27,5 mm



Office space with Heartfelt® acoustic ceiling system and Opal Light Bar, Art.nr. 179-024.

HeartFelt® | Ceiling & Wall Lights

HEARTFELT® LIGHT BAR | REFLECTOR/OPAL

Especially developed for the HeartFelt® Modular and Acoustic Ceiling system. In 3000K or 4000K with reflector or opal cover, Flicker-free Triac or Dali dimmable Driver excluded.



Input voltage: 200-240V
Power: 38/41W
Dimmable: Yes
Beam angle: : 70° x 70° (reflector) 120° (opal)
Color temperature: 3000K/4000K
IP rate: IP20
Connection type: Connector
Housing material: Aluminium/PC



ART. NR.	TYPE	POWER	LUMINOUS FLUX	COLOR TEMP. (CCT)	LIGHT COLOR	LENGTH	WIDTH	HEIGHT
179-002	Reflector	38 Watt	3900 Lm	3000K	● Warm white	1375 mm	40 mm	35 mm
179-004	Reflector	38 Watt	3900 Lm	4000K	○ Natural white	1375 mm	40 mm	35 mm
179-022	Opal	41 Watt	3600 Lm	3000K	● Warm white	1375 mm	40 mm	35 mm
179-024	Opal	41 Watt	3600 Lm	4000K	○ Natural white	1375 mm	40 mm	35 mm

ACCESSORIES

ART. NR.	TYPE
179-061	Phase-Cut Dim Driver for Ceiling Light Bar Wieland 3P connector
179-060	Dali Driver for Ceiling Light Bar Wieland 5P Connector
179-050	Coupler for Ceiling Light Bar
179-080	Mounting Brackets 2pcs Ceiling Light Bar HeartFelt 40HL55
179-081	Mounting Brackets 2pcs Ceiling Light Bar HeartFelt 40HL80
179-082	Mounting Brackets 2pcs Ceiling Light Bar HeartFelt 40HL105



Art.nr. 179-061



Art.nr. 179-060



Art.nr. 179-050



Art.nr. 179-080, 179-081, 179-082

Especially developed for Heartfelt® ceilings

The Tronix 'Ceiling light bar' is especially developed for Hunter Douglas HeartFelt® Modular and Acoustic Ceiling System: an advanced system for architects, installers and building owners that delivers the right acoustics in every single room, setting or environment.

This sophisticated 'light bar' can easily be attached to the HeartFelt® ceiling carrier system with matching mounting brackets to hold them in place. They can be applied in one single line, in a more playful way, or just in the most efficient way possible.

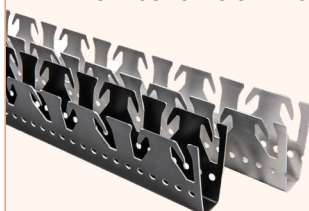

*The lightbar can be easily attached to any existing HeartFelt® ceiling carrier system with mounting brackets to hold them in place.

Speciaal ontwikkeld voor Heartfelt® plafonds

De armaturen voor HeartFelt plafonds zijn speciaal ontwikkeld voor het Hunter Douglas HeartFelt® Modulaire en akoestisch plafondsysteem: een geavanceerd systeem voor architecten, installateurs en gebouw eigenaren dat in elke ruimte, setting of omgeving de juiste akoestiek levert.

Dit armatuur kan eenvoudig worden bevestigd aan het HeartFelt® plafonddragersysteem met montagebeugels om ze op hun plaats te houden. De armaturen kunnen in één lijn worden toegepast, op een meer speelse manier, of juist op de meest efficiënte manier.

Ceiling & Wall Lights | Ceiling Lights

DOWNLIGHT SURFACE | TRI-WHITE | DIMMABLE

With CCT switch for pre-settable color temperature 3000K - 4000K - 5700K



Input voltage: 200-240V

Dimming method: Triac

Beam angle: 90°

IP rate: IP20

Connection type: Terminal block

Housing material: Aluminium

Housing color: Black or white

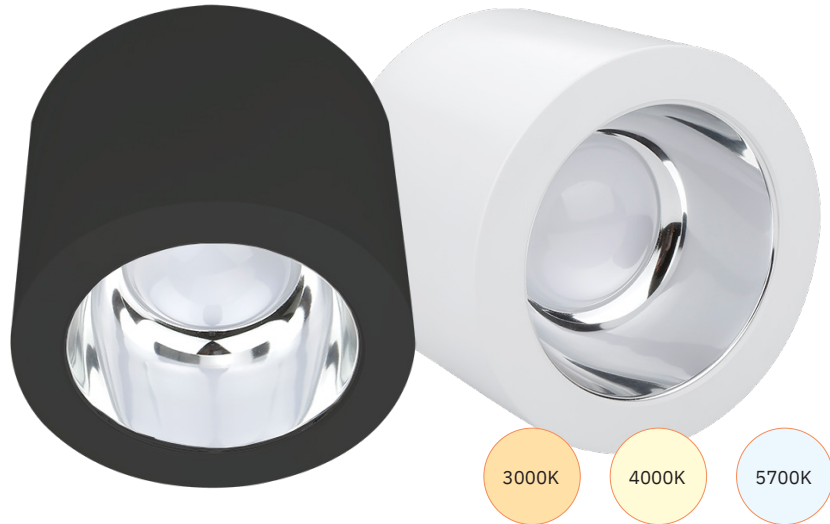

ART.NR.	HOUSING COLOR	POWER	LUMINOUS FLUX	LIGHT COLOR	DIAMETER	HEIGHT
136-097	● Black	13 Watt	1050-1260-1170 Lm	Tri-white	Ø 143 mm	112 mm
136-096	○ White	13 Watt	1050-1260-1170 Lm	Tri-white	Ø 143 mm	112 mm
136-099	● Black	18 Watt	1440-1670-1530 Lm	Tri-white	Ø 170 mm	124 mm
136-098	○ White	18 Watt	1440-1670-1530 Lm	Tri-white	Ø 170 mm	124 mm

TRIAC LED DIMMERS

ART NR.	POWER
215-131	2W - 350W
215-135	2X 2W - 100W

Ceiling Lights | Ceiling & Wall Lights

CEILING LIGHT | ADJUSTABLE | FLAME DIMMABLE

Flame dimmable from 3000K/2800K to 2000K



Input voltage: 220-240V

Dimming method: Triac (flame)

Beam angle: 40°

IP rate: IP44

Connection type: Terminal block

Housing material: Aluminium

Housing color: Black or white



ART.NR.	HOUSING COLOR	POWER	LUMINOUS FLUX	COLOR TEMP. (CCT)	LIGHT COLOR	SIZE (L X W X H)
136-232	● Black	8 Watt	450 - 350 Lm	3000K-2000K	○● Warm white~Warm white++	135 x 135 x 60 mm
136-231	○ White	9 Watt	620 Lm	2800K-2000K	○● Warm white~Warm white++	126 x 126 x 82 mm

TRI-white: always the right color

TRI-white lighting has a so-called CCT switch on the back, that allows you to pre-set the lamp in three different light colors: warm white, natural white and cold white. In this way, you can always choose the right light color for your application.

TRI-white: altijd de juiste kleur

TRI-white verlichting heeft aan de achterkant een zogeheten CCT-switch, waardoor de lamp in drie verschillende lichtkleuren ingesteld kan worden: warm wit, neutraal wit en koud wit. Zo kan de lichtkleur altijd naar behoefte worden ingesteld.





Our successful Tronix Light Cube (Art.nr. 149-144) beautifully decorates design restaurant Twin Pancakes in Uden - The Netherlands

Wall Lights | Ceiling & Wall Lights

WALL LAMP | CUBE | UP & DOWN | 6W | DIMMABLE

With two independently adjustable beam angles (1° to 120°).

Input voltage: 220-240V
Power: 6 Watt
Dimming method: Triac
Beam angle: 2 x 1° to 120° (independently adjustable)
IP rate: IP65
Connection type: Terminal block
Housing material: Aluminium
Housing color: Black, white or grey (RAL7016)



ART.NR.	HOUSING COLOR	POWER	LUMINOUS FLUX	COLOR TEMP. (CCT)	LIGHT COLOR	SIZE (L X W X H)
149-138	● Black	6 Watt	2 x 110 Lm	2300K	● Warm white++	100 x 100 x 101 mm
149-139	○ White	6 Watt	2 x 110 Lm	2300K	● Warm white++	100 x 100 x 101 mm
149-134	● Grey (RAL7016)	6 Watt	2 x 110 Lm	2300K	● Warm white++	100 x 100 x 101 mm
149-144	● Black	6 Watt	2 x 110 Lm	2700K	● Warm white+	100 x 100 x 101 mm
149-145	○ White	6 Watt	2 x 110 Lm	2700K	● Warm white+	100 x 100 x 101 mm
149-133	● Grey (RAL7016)	6 Watt	2 x 110 Lm	2700K	● Warm white+	100 x 100 x 101 mm
149-142	● Black	6 Watt	2 x 110 Lm	3000K	○ Warm white	100 x 100 x 101 mm
149-143	○ White	6 Watt	2 x 110 Lm	3000K	○ Warm white	100 x 100 x 101 mm
149-132	● Grey (RAL7016)	6 Watt	2 x 110 Lm	3000K	○ Warm white	100 x 100 x 101 mm

WALL LAMP | CUBE | UP & DOWN | 20W | DIMMABLE

With two independently adjustable beam angles (1° to 120°).

Input voltage: 220-240V
Power: 20 Watt
Dimming method: Triac
Beam angle: 2 x 1° to 120° (independently adjustable)
IP rate: IP65
Connection type: Terminal block
Housing material: Aluminium
Housing color: Black



ART.NR.	HOUSING COLOR	POWER	LUMINOUS FLUX	COLOR TEMP. (CCT)	LIGHT COLOR	SIZE (L X W X H)
149-244	● Black	20 Watt	2 x 254 Lm	2700K	● Warm white+	200 x 100 x 101 mm
149-242	● Black	20 Watt	2 x 287 Lm	3000K	○ Warm white	200 x 100 x 101 mm

TRIAC LED DIMMERS

ART NR.	POWER
215-131	2W - 350W
215-135	2X 2W - 100W

Ceiling & Wall Lights | Wall Lights

WALL LAMP | ROUND | UP & DOWN | 6W DIMMABLE

With two independently adjustable beam angles (1° to 120°).

Input voltage: 220-240V

Power: 6 Watt

Dimming method: Triac

Beam angle: 2 x 1° to 120° (independently adjustable)

IP rate: IP65

Connection type: Terminal block

Housing material: Aluminium

Housing color: Black or white



ART.NR.	HOUSING COLOR	POWER	LUMINOUS FLUX	COLOR TEMP. (CCT)	LIGHT COLOR	SIZE (L X W X H)
149-148	● Black	6 Watt	2 x 110 Lm	2700K	● Warm white+	136 x 115 x 100 mm
149-149	○ White	6 Watt	2 x 110 Lm	2700K	● Warm white+	136 x 115 x 100 mm
149-146	● Black	6 Watt	2 x 110 Lm	3000K	○ Warm white	136 x 115 x 100 mm
149-147	○ White	6 Watt	2 x 110 Lm	3000K	○ Warm white	136 x 115 x 100 mm

WALL LAMP | DOWNLIGHT | 5,8W | 2700K DIMMABLE

Pyramid shaped downlight with a beam angle of 36°.

Input voltage: 220-240V

Power: 5,8 Watt

Dimming method: Triac

Beam angle: 36°

IP rate: IP65

Connection type: Terminal block

Housing material: Aluminium

Housing color: Black



ART.NR.	HOUSING COLOR	POWER	LUMINOUS FLUX	COLOR TEMP. (CCT)	LIGHT COLOR	SIZE (L X W X H)
149-170	● Black	5,8 Watt	640 Lm	2700K	● Warm white+	143 x 90 x 90 mm

Wall Lights | Ceiling & Wall Lights

WALL LAMP | UP- & DOWNLIGHT | 5,5W | 3000K NON DIMMABLE



Up- and downlight with a beam angle of 25°, ultra small fixture; 100 mm.

Input voltage: 220-240V
Power: 5,5 Watt
Dimmable: No
Beam angle: 25°
IP rate: IP65
Connection type: Terminal block
Housing material: Aluminium
Housing color: Black



ART.NR.	HOUSING COLOR	POWER	LUMINOUS FLUX	COLOR TEMP. (CCT)	LIGHT COLOR	SIZE (L X W X H)
149-160	● Black	5,5 Watt	2 x 161 Lm	3000K	○ Warm white	100x61x38 mm

WALL LAMP | UP- & DOWNLIGHT | 2 SIZES | DIMMABLE



Black or white up- and downlight in two sizes.

Input voltage: 220-240V
Power: 6,9/12,9 Watt
Dimming method: Triac
Beam angle: 90°
IP rate: IP54
Connection type: Terminal block
Housing material: Aluminium
Housing color: Black or white



ART.NR.	HOUSING COLOR	POWER	LUMINOUS FLUX	COLOR TEMP. (CCT)	LIGHT COLOR	SIZE (L X W X H)
149-150	● Black	6,9 Watt	2 x 346 Lm	2700K	○ Warm white+	115 x 90 x 28 mm
149-151	○ White	6,9 Watt	2 x 346 Lm	2700K	○ Warm white+	115 x 90 x 28 mm
149-155	● Black	12,9 Watt	2 x 508 Lm	2700K	○ Warm white+	175 x 90 x 28 mm
149-156	○ White	12,9 Watt	2 x 508 Lm	2700K	○ Warm white+	175 x 90 x 28 mm

Ceiling & Wall Lights | Floor Lamp

FLOOR LAMP | 81W | 3500K | USB&230V SOCKET | BLACK & WHITE

With two USB ports for charging mobile devices and a 230V contact point for connecting a laptop or desktop.



Input voltage: 200-240V

Power: 81 Watt

Dimming method: Button on lamp

Beam angle: 30°

IP rate: IP20

Connection type: Europlug

Housing material: Aluminium

Housing color: Black (RAL9005) or white (RAL9016)



ART.NR.	HOUSING COLOR	POWER	LUMINOUS FLUX	COLOR TEMP. (CCT)	LIGHT COLOR	SIZE (L X W X H)
138-001	● Black	81 Watt	3000 Lm (up) 6000 Lm (down)	3500K	○ Warm white	360 x 1120 x 2000 mm
138-011	○ White	81 Watt	3000 Lm (up) 6000 Lm (down)	3500K	○ Warm white	360 x 1120 x 2000 mm



*NSVV report 'functional home-office lighting' (Dutch)

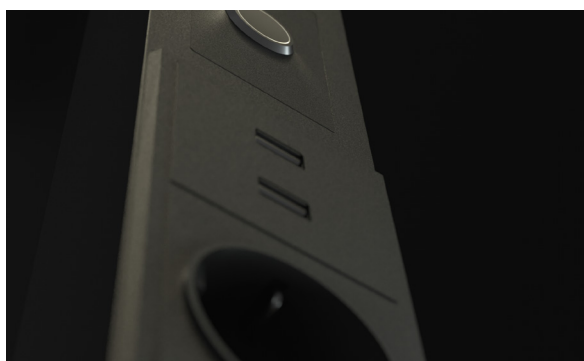

THE IMPORTANCE OF FUNCTIONAL HOME OFFICE LIGHTING

To respond to the need of efficient home office lighting, we have developed a floor lamp that is all about functionality and aesthetics. This lamp will help you maintain maximum concentration while allowing you to adjust the light intensity to your specific needs via the dimming function.

This floor lamp also has 2 USB ports for charging mobile devices and a 230V connection point for connecting a laptop or desktop.

- **2x USB port (total 2.1A)** and 1x 230V connection point at 1m height
- **1 button** for on/off and dimming
- **Up- & Downlight** 3000Lm (Uplight) 6000Lm (Downlight)
- **50.000 working hours** 5 year warranty
- **High quality material and finish** Aluminum housing and PMMA lens
- **CE, RoHS and ENEC** certified



Tronix Floor Lamp especially designed for functional home office lighting

4

Track Light

Powerful light sources for efficient lighting and natural looking colors in retail and hospitality







Tronix Track Lights at food store Pincho Copa, Uden - The Netherlands



Linear | Track Light

3 PHASE TRACK | TRACK SPOT | BLACK



Input voltage: 220-240V
Power: 8/20/30 Watt
Power factor: >0.95
LED qty: 1 pc
LED type: SMD
Beam angle: 40°
CRI value: >80
IP rate: IP20
Connection type: 3-phase adaptor



ART.NR.	HOUSING	POWER	LUMINOUS FLUX	COLOR TEMP.(CCT)	LIGHT COLOR	BEAM ANGLE	DIMMABLE	LENGTH	DIAMETER Ø
169-272	● Black	8 Watt	660 Lm	2200K	● Warm white++	40°	Yes	125 mm	Ø 60 mm
169-270	● Black	8 Watt	660 Lm	2700K	● Warm white+	40°	Yes	125 mm	Ø 60 mm
169-294	● Black	20 Watt	1706 Lm	2700K	● Warm white+	40°	Yes	186 mm	Ø 80 mm
169-290	● Black	20 Watt	1706 Lm	3000K	● Warm white	40°	Yes	186 mm	Ø 80 mm
169-360	● Black	30 Watt	2400 Lm	3000K	● Warm white	40°	Yes	210 mm	Ø 90 mm

3 PHASE TRACK | TRACK SPOT | WHITE



Input voltage: 220-240V
Power: 8/20/30 Watt
Power factor: >0.95
LED qty: 1 pc
LED type: SMD
Beam angle: 40°
CRI value: >80
IP rate: IP20
Connection type: 3-phase adaptor



For more design options, every white Track Spot, comes with a white and black inner ring

ART.NR.	HOUSING	POWER	LUMINOUS FLUX	COLOR TEMP.(CCT)	LIGHT COLOR	BEAM ANGLE	DIMMABLE	LENGTH	DIAMETER Ø
169-273	○ White	8 Watt	660 Lm	2200K	● Warm white++	40°	Yes	125 mm	Ø 60 mm
169-271	○ White	8 Watt	660 Lm	2700K	● Warm white+	40°	Yes	125 mm	Ø 60 mm
169-295	○ White	20 Watt	1706 Lm	2700K	● Warm white+	40°	Yes	186 mm	Ø 80 mm
169-291	○ White	20 Watt	1706 Lm	3000K	● Warm white	40°	Yes	186 mm	Ø 80 mm
169-361	○ White	30 Watt	2400 Lm	3000K	● Warm white	40°	Yes	210 mm	Ø 90 mm



Tronix Linear Track Lights at post office depot 't Handelshuys in Uden - The Netherlands

Linear | Track Light

3 PHASE TRACK | LINEAR LIGHT | 16W | TRI-WHITE

With CCT switch for pre-settable color temperature 3000K - 4000K - 5700K.



Input voltage: 220-240V
Power: 16 Watt
Power factor: >0.9
LED type: SMD
Dimmable: No
Beam angle: 110°
CRI value: >80
IP rate: IP20
Length: 650 mm
Width: 32,5 mm
Height: 52 mm
Connection type: 3-phase adaptor

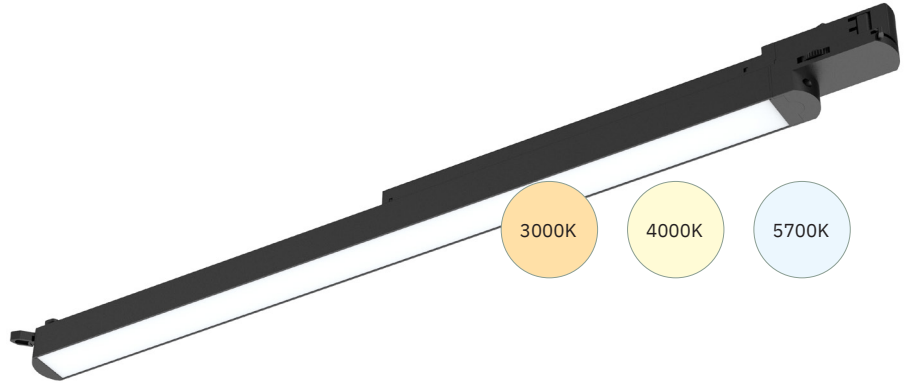

ART. NR.	HOUSING	POWER	LUMINOUS FLUX	COLOR TEMP. (CCT)	LIGHT COLOR
169-307	● Black	16 Watt	1547/1725/1620 Lm	3000K/4000K/5700K	Warm white/Natural white/Cold white

3 PHASE TRACK | LINEAR LIGHT | 16W | 3000K REFLECTOR



Input voltage: 100-240V
Power: 16 Watt
Power factor: >0.9
LED qty: 48 pcs
LED type: SMD2835
Dimmable: No
Beam angle: 110°
CRI value: >80
IP rate: IP20
Length: 650 mm
Width: 32 mm
Height: 52 mm
Connection type: 3-phase adaptor

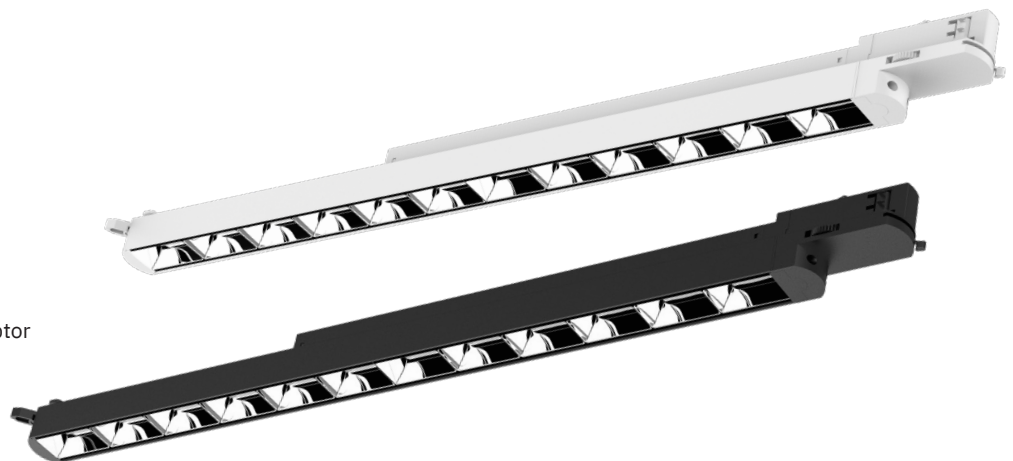

ART.NR	HOUSING	POWER	LUMINOUS FLUX	COLOR TEMP. (CCT)	LIGHT COLOR
169-310	● Black	16 Watt	1600 Lm	3000K	○ Warm white
169-311	○ White	16 Watt	1600 Lm	3000K	○ Warm white

Track Light | 3-Phase Rail & Accessories

POWER CONNECTOR



ART. NR. COLOR

169-042 ● Black

169-007 ● Silver

169-025 ○ White

ART. NR. COLOR

169-043 ● Black

169-015 ● Silver

169-026 ○ White

ENDCAP

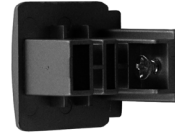

ART. NR. COLOR

169-041 ● Black

169-006 ● Silver

169-024 ○ White

L-CONNECTOR

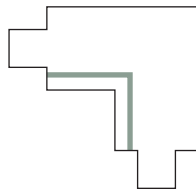
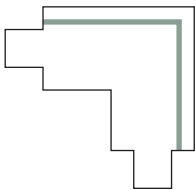

ART. NR. COLOR

169-048 ● Black

169-011 ● Silver

169-031 ○ White

ART. NR. COLOR

169-049 ● Black

169-017 ● Silver

169-032 ○ White

X-CONNECTOR



ART. NR. COLOR

169-045 ● Black

169-009 ● Silver

169-028 ○ White

L-CONNECTOR ADJUSTABLE



ART. NR. COLOR

169-012 ● Silver

INTERIOR CONNECTOR



ART. NR. COLOR

169-040 ● Black

169-005 ● Silver

169-023 ○ White

FLEXIBLE CONNECTOR

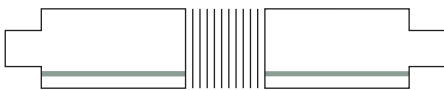

ART. NR. COLOR

169-072 ● Black

169-013 ● Silver

169-035 ○ White

I-CONNECTOR



ART. NR. COLOR

169-044 ● Black

169-008 ● Silver

169-027 ○ White

T-CONNECTOR

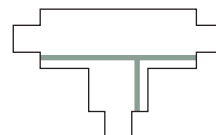
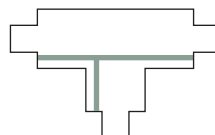
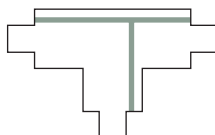
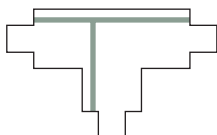

ART. NR. COLOR

169-046 ● Black

169-010 ● Silver

169-029 ○ White

ART. NR. COLOR

169-047 ● Black

169-016 ● Silver

169-030 ○ White

ART. NR. COLOR

169-101 ● Black

169-102 ● Silver

169-103 ○ White

ART. NR. COLOR

169-104 ● Black

169-105 ● Silver

169-106 ○ White

3-Phase Rail & Accessories | Track Light

3 PHASE ADAPTER

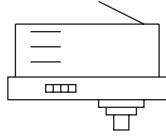

ART. NR.	COLOR
169-074	● Black
169-020	● Silver
169-037	○ White

EMERGENCY TRACKLIGHT

NEW

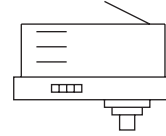

ART. NR.	COLOR	LUMINOUS FLUX
600-033	● Black	200 lm

PENDING

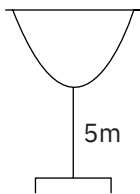

ART. NR.	COLOR
169-073	● Black
169-014	● Silver
169-036	○ White

MOUNTING BRACKET

To connect rails screwless on to suspended ceilings

NEW



ART. NR.	COLOR
169-120	● Black
169-119	○ White

SURFACE MOUNTED FIXTURE



ART. NR.	COLOR
169-113	● Black
169-112	○ White

SUSPENSION KIT

To connect rails screwless on to suspended ceilings (with pendel)

NEW



ART. NR.	COLOR
169-118	● Black

3-PHASE TRACK RAIL



ART. NR.	COLOR
169-108	● Black
169-107	● Silver
169-109	○ White

Rail 2 meter

ART. NR.	COLOR
169-038	● Black
169-002	● Silver
169-021	○ White

Rail 3 meter

ART. NR.	COLOR
169-039	● Black
169-003	● Silver
169-022	○ White

5 Recessed Fixtures

For elegant lighting
results in any ceiling





Recessed Fixtures | Trimless

RECESSED MOUNTING FIXTURE | 50MM | FULLY ADJUSTABLE

Delivered with fixed frame and trimless frame. To be used with 50 mm lamp (not included)



Housing: Black or White

Material: Iron, power coated

Use in combination with: 50 mm lamp, see page 78 and 79



ART. NR.	COLOR	MOUNTING HOLE RECESSED	SIZE - RECESSED (LXWXH)	SIZE - INCL. TRIMLESS FRAME (LXWXH)	FIXTURE TYPE
148-060	● Black	90 x 90 mm	119 x 119 x 100 mm	140 x 140 x 100 mm	Single
148-061	○ White	90 x 90 mm	119 x 119 x 100 mm	140 x 140 x 100 mm	Single
148-062	● Black	184 x 91 mm	219 x 119 x 102 mm	241 x 95 x 100 mm	Double
148-063	○ White	184 x 91 mm	219 x 119 x 102 mm	241 x 95 x 100 mm	Double

RECESSED MOUNTING FIXTURE | AR70 | FULLY ADJUSTABLE

Delivered with fixed frame and trimless frame. To be used with AR70 lamp (not included)



Housing: Black or White

Material: Iron, powder coated

Use in combination with: AR70 lamp (with GU10 socket), see page 80



ART. NR.	COLOR	MOUNTING HOLE RECESSED	SIZE - RECESSED (LXWXH)	SIZE - INCL. TRIMLESS FRAME (LXWXH)	FIXTURE TYPE
148-050	● Black	108 x 108 mm	137 x 137 x 100 mm	145 x 145 x 100 mm	Single
148-051	○ White	108 x 108 mm	137 x 137 x 100 mm	145 x 145 x 100 mm	Single
148-052	● Black	210 x 110 mm	240 x 137 x 100 mm	260 x 155 x 100 mm	Double
148-053	○ White	210 x 110 mm	240 x 137 x 100 mm	260 x 155 x 100 mm	Double

RECESSED MOUNTING FIXTURE | AR111 | FULLY ADJUSTABLE

Delivered with fixed frame and trimless frame. To be used with AR111 lamp (not included)



Housing: Black or White

Material: Iron, powder coated

Use in combination with: AR111 lamp, see page 81



ART. NR.	COLOR	MOUNTING HOLE RECESSED	SIZE - RECESSED (LXWXH)	SIZE - INCL. TRIMLESS FRAME (LXWXH)	FIXTURE TYPE
148-043	● Black	152 x 152 mm	192 x 192 x 100 mm	197 x 197 x 100 mm	Single
148-044	○ White	152 x 152 mm	192 x 192 x 100 mm	197 x 197 x 100 mm	Single
148-045	● Black	336 x 152 mm	375 x 192 x 100 mm	384 x 197 x 100 mm	Double
148-046	○ White	336 x 152 mm	375 x 192 x 100 mm	384 x 197 x 100 mm	Double



Tronix Trimless fixtures AR70 in a modern apartment in Nistelrode - The Netherlands



Recessed mounting fixtures in a modern kitchen in Uden - The Netherlands

Trimless Fixtures

1. Choose 'trimless' or 'recessed'

Tronix Trimless Fixtures are provided with both a recessed frame and a separate plaster frame. Choose recessed for a visible frame (fig.1) in ●○, or choose the plaster frame for a seamless ceiling without any visible outer frame (fig.2).



Fig 1. Recessed mounted



Fig 2. Trimless (invisible frame)

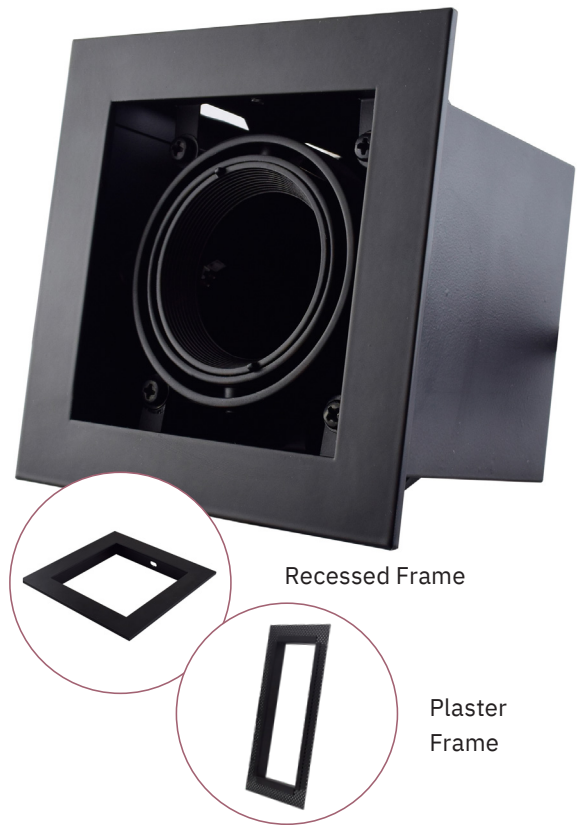

2. How to install

Installation of a recessed frame is easy: the luminaire can be mounted in the ceiling with mounting clips. In case of a plaster frame, the frame is attached behind a ceiling plate, after which the plate can be plastered.

3. Light source

Tronix Trimless Fixtures are suitable for Ø 50 mm, Ø 70 mm or Ø 111 mm spots. For matching spots, see P81

4. Fully adjustable

The fixtures are fully adjustable, making them ideal for atmospheric, homogeneous lighting results in any desired direction.



Scan for
installation
manual



Recessed Fixtures | Ø50 MM

Non Adjustable

Use in combination with:
Ø50 mm lamp, see page 78-79

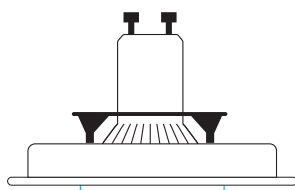

MODEL	1 hole plate round
DIMENSIONS	Ø 75 mm
MOUNTING	Ø 68 mm
ALUMINIUM	● 148-572
WHITE	○ 148-573
BLACK	● 148-582



MODEL	1 hole plate square
DIMENSIONS	85 x 85 mm
MOUNTING	Ø 70 mm
ALUMINIUM	● 148-578
WHITE	○ 148-579

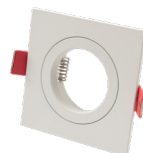

MODEL	1 hole plate square
DIMENSIONS	79 x 79 mm
MOUNTING	Ø 65 mm
ALUMINIUM	● 148-552
WHITE	○ 148-556



MODEL	1 hole plate round
DIMENSIONS	Ø 80 mm
MOUNTING	Ø 65 mm
ALUMINIUM	● 148-570
WHITE	○ 148-571



MODEL	1 hole plate round
DIMENSIONS	Ø 84 mm
MOUNTING	Ø 60 mm
ALUMINIUM	● 148-550
WHITE	○ 148-558
BLACK	● 148-585



MODEL	1 hole plate round
DIMENSIONS	Ø 85 mm
MOUNTING	Ø 70 mm
ALUMINIUM	● 148-576
WHITE	○ 148-577
BLACK	● 148-581



MODEL	1 hole plate round
DIMENSIONS	Ø 79 mm
MOUNTING	Ø 65 mm
ALUMINIUM	● 148-551
WHITE	○ 148-555
BLACK	● 148-586

Adjustable

Use in combination with:
Ø50 mm lamp, see page 78-79

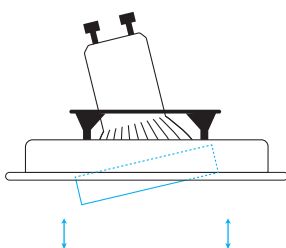

MODEL	1 hole plate round
DIMENSIONS	Ø 90 mm
MOUNTING	Ø 76 mm
WHITE	○ 148-565
BLACK	● 148-584



MODEL	1 hole plate round
DIMENSIONS	Ø 92 mm
MOUNTING	Ø 80 mm
ALUMINIUM	● 148-553
WHITE	○ 148-557
BLACK	● 148-563



MODEL	1 hole plate round
DIMENSIONS	Ø 83 mm
MOUNTING	Ø 72 mm
ALUMINIUM	● 148-507
WHITE	○ 148-569
BLACK	● 148-580



MODEL	1 hole plate square
DIMENSIONS	92 x 92 mm
MOUNTING	Ø 80 mm
ALUMINIUM	● 148-559
WHITE	○ 148-560
BLACK	● 148-583



MODEL	1 hole plate round
DIMENSIONS	Ø 75 mm
MOUNTING	Ø 68 mm
ALUMINIUM	● 148-574
WHITE	○ 148-575

AR70-AR111 | Recessed Fixtures

AR70 Plates - Adjustable

Use in combination with: AR70 lamp, see page 80

Size: Ø128 mm

Housing material: Aluminium

Housing color: Black, aluminium or white

ART. NR.	COLOR	MOUNTING HOLE	MOUNTING (HEIGT RECESSED)
148-027	● Black	Ø 100 mm	25 mm
148-028	○ White	Ø 100 mm	25 mm
148-026	● Aluminium	Ø 100 mm	25 mm

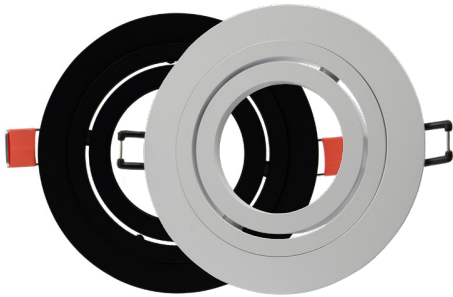
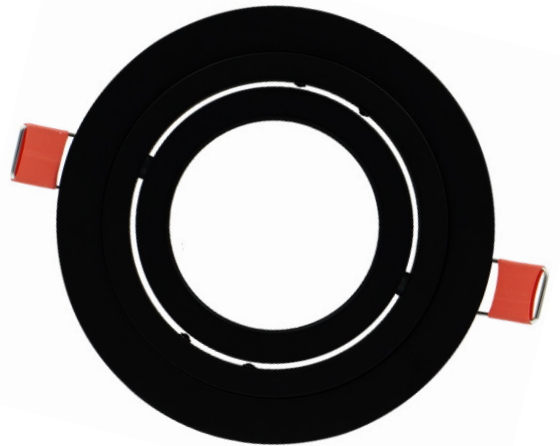

Available in black, white or aluminium.



Fits perfectly with 175-370/175-372 (Black) or 175-343/175-347/175-344 (Alu)

AR111 PLATES - ADJUSTABLE

Use in combination with: AR111 lamp, see page 81

ART.NR.	MODEL	DIMENSIONS	MOUNTING
148-030	1 hole plate round AR111 - Aluminium	Ø 180 mm	Ø 150 mm
148-033	1 hole plate round AR111 - White	Ø 180 mm	Ø 150 mm
148-036	1 hole plate round AR111 - Black	Ø 180 mm	Ø 150 mm
148-031	1 hole plate square AR111 - Aluminium	180 x 180 mm	Ø 150 mm
148-034	1 hole plate square AR111 - White	180 x 180 mm	Ø 150 mm
148-037	1 hole plate square AR111 - Black	180 x 180 mm	Ø 150 mm
148-032	2 hole plate square AR111 - Aluminium	355 x 180 mm	325 x 150 mm
148-035	2 hole plate square AR111 - White	355 x 180 mm	325 x 150 mm
148-038	2 hole plate square AR111 - Black	355 x 180 mm	325 x 150 mm



Art. nr. 148-030



Art. nr. 148-033



Art. nr. 148-036

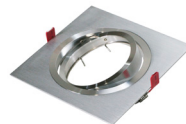

Art. nr. 148-031

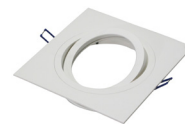

Art. nr. 148-034



Art. nr. 148-037



Art. nr. 148-032



Art. nr. 148-035



Art. nr. 148-038

6 LED Tubes & Lamps

A complete range to suit any
purpose and get great savings





LED TL's & Lamps | Ø 50 mm Lamps

GU10 LED LAMP | 5 WATT COB

Replacement for 30W halogen spot



Input voltage: 220-240V
Power: 5 Watt
LED type: COB
CRI value: >92
Dimmable: Yes (Triac)

Beam angle: 24°
IP rate: IP20
Length: 60 mm
Diameter: Ø 50 mm
Housing: Aluminium/Silver



ART. NR.	POWER	LUMINOUS FLUX	COLOR TEMP. (CCT)	LIGHT COLOR	DIMMABLE
175-137	5 Watt	250 Lm	2700K	○ Warm white+	Yes (Triac)

Ø 50 MM LED SPOT | 5 WATT | 38° | 2700K

Perfect substitute for all Ø50 mm GU10 Spots. A similar sized all performance with a height of only 26mm suitable in any ceiling application.



Input voltage: 220-240V
Power: 5 Watt
LED type: SMD
CRI value: >80
Dimmable: Yes >1% (Triac)

Beam angle: 38°
IP rate: IP20
Height: 26 mm (31 mm with cable)
Diameter: Ø 50 mm
Housing: Black or white



ART. NR.	HOUSING COLOR	POWER	LUMINOUS FLUX	COLOR TEMP. (CCT)	LIGHT COLOR	DIMMABLE
175-550	○ White	5 Watt	400 Lm	2700K	○ Warm white+	Yes (Triac)
175-570	● Black	5 Watt	400 Lm	2700K	○ Warm white+	Yes (Triac)

Winner Spot replaces GU10 light source

Tronix Lighting introduces the perfect substitute for all Ø50mm GU10 Spots: a similar sized all-performance LED Spot that has an incredibly stable dimming function and does NOT flicker. This alternative LED Spot with internal led driver only counts 26 mm in height (31 mm with cable) for a suitable fit with just any ceiling application. In addition, this competitive light source has a connection block with strain relief, enabling a direct connection onto 230V: a winning solution!

FEATURES:

- Stable and flicker-free
- Only 26 mm in height, cable 15 cm

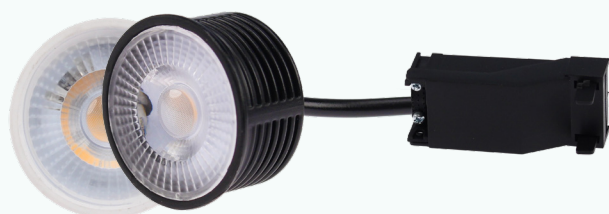

Winner Spot vervangt GU10 lichtbron

Tronix Lighting lanceert dé vervanger voor Ø50mm GU10 Spotjes. Een Ø50 mm LED Spot, speciaal ontwikkeld om stabiel te dimmen zonder te flikkeren. De vervangende LED Spots zijn slechtst 26 mm hoog (31 mm met kabeldikte) inclusief interne driver en daardoor geschikt voor nagenoeg iedere plafondsituatie. Daarnaast heeft de Tronix LED Spot een aansluitblokje met trekontlasting voor directe aansluiting op 230V, waardoor dit spotje een must is voor iedereen!

KENMERKEN:

- Stabiel en flikkervrij
- Slechts 26 mm hoog, kabel 15 cm lang

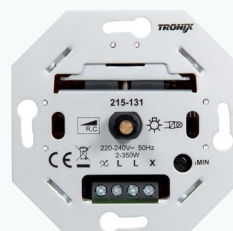

For a perfect dimming result, use the LED Spot with the Tronix universal Triac LED Dimmer (art. nr. 215-131).

Ø 50 mm Lamps | LED Tubes & Lamps

GU10 | 5W | 2700K OR 2000~2700K FLAME DIM. | CRI >97



Input voltage: 220-240V
Power: 5 Watt
LED type: COB
CRI value: >97
Dimmable: Yes (Triac)

IP rate: IP20
Length: 58 mm
Diameter: Ø 50 mm
Housing: Aluminium/Silver



ART. NR.	POWER	LUMINOUS FLUX	COLOR TEMP. (CCT)	LIGHT COLOR	BEAM ANGLE	DIMMABLE
175-142	5 Watt	350 Lm	2000~2700k	● Flame Dimming	45°	Yes (Triac)
175-143	5 Watt	350 Lm	2700K	● Warm white	35°	Yes (Triac)

GU10 LED LAMP | 7W | COB



Input voltage: 220-240V
Power: 7 Watt
LED type: COB
Dimmable: Yes (Triac)
Beam angle: 35°

IP rate: IP20
Length: 73 mm
Diameter: Ø 50 mm
Housing: Aluminium/Silver



ART. NR.	POWER	LUMINOUS FLUX	COLOR TEMP. (CCT)	LIGHT COLOR	BEAM ANGLE	DIMMABLE
175-144	7 Watt	600 Lm	2700K	● Warm white	35°	Yes (Triac)

MR16 LED LAMP | 5 WATT COB



Input voltage: 12V AC/DC
Power: 5 Watt
LED qty: 1 pc
LED type: COB
Dimmable: No
CRI value: >82

Beam angle: 24°
IP rate: IP20
Length: 51 mm
Diameter: Ø 50 mm
Connection type: MR16
Housing: Aluminium, Silver



ART. NR.	POWER	LUMINOUS FLUX	COLOR TEMP. (CCT)	LIGHT COLOR
175-138	5 Watt	250 Lm	2700K	● Warm white+

MR16 LED LAMP | 5 WATT COB



Input voltage: 12V AC/DC
Power: 5W
LED qty: 1
LED type: COB
Dimmable: No
CRI value: >80

Beam angle: 45°
IP rate: IP20
Length: 50 mm
Diameter: Ø 50 mm
Connection type: MR16
Housing: Aluminium, Silver



ART. NR.	POWER	LUMINOUS FLUX	COLOR TEMP.(CCT)	LIGHT COLOR
175-154	5 Watt	400 Lm	2700K	● Warm white+

LED Tubes & Lamps | Ø 70 mm Lamps

AR70 LED LAMP | 6/7 WATT | GU10

In 2700K, 3000K or with Flame Dimming 2000K~2700K



Input voltage: 220-240V
Power: 6/7 Watt
LED type: COB
LED qty: 1
Dimmable: Yes
Beam angle: 24°/36°
CRI value: >92 Ra
IP rate: IP20
Diameter: Ø70 mm
Height: 62 mm
Connection type: GU10
Housing: Aluminium



ART. NR.	POWER	BEAM	CRI	LUMINOUS FLUX	COLOR TEMP. (CCT)	LIGHT COLOR	DIMMABLE
175-344	6 Watt	24°	>92	300 Lm	2000K~2700K	● Warm white++	Yes, flame dimming
175-343	6 Watt	24°	>92	300 Lm	2700K	● Warm white+	Yes
175-347	6 Watt	24°	>92	300 Lm	3000K	● Warm white	Yes
175-350	7 Watt	36°	>92	300 Lm	2000K~2700K	● Warm white++	Yes, flame dimming

AR70 LED LAMP | 7 WATT DIMMABLE DRIVER | B15D

Including external dimmable driver with EU Plug and B15D socket



Input voltage: 220-240V
Power: 7 Watt
LED type: CREE/Shineon
LED qty: 1
Dimmable: Yes
Beam angle: 36°
CRI value: >92/95 Ra
IP rate: IP20
Diameter: Ø70 mm
Height: 49 mm
Connection type: B15D
Housing: Aluminium



ART. NR.	POWER	CRI	LUMINOUS FLUX	COLOR TEMP. (CCT)	LIGHT COLOR	DIMMABLE
175-370	7 Watt	>95	300 Lm	2700K	● Warm white+	Yes
175-372	7 Watt	>92	300 Lm	2000K~2700K	● Warm white++	Yes, flame dimming

Ø 111 mm Lamps | LED Tubes & Lamps

AR111 LED LAMP | 12 WATT | DIMMABLE

External driver with Europlug included



Input voltage: 220-240V
Power: 12 Watt
LED type: COB
LED qty: 1
CRI value rate: >92 Ra
IP rate: IP20
Diameter: Ø111 mm
Height: 60 mm
Connection type: Terminal block



ART. NR.	POWER	LUMINOUS FLUX	COLOR TEMP. (CCT)	LIGHT COLOR	DIMMABLE	BEAM ANGLE
175-316	12 Watt	600 Lm	2000K ~ 2900K	☉ Warm white ~ Warm white ++	Yes, flame dimming	36°
175-323	12 Watt	650 Lm	2700K	☉ Warm white	Yes	24°
175-324	12 Watt	650 Lm	3000K	☉ Warm white	Yes	24°

AR111 LED LAMP | RGB



Input voltage: 12V
Power: 7 Watt
LED qty: 6
Dimmable: Yes
Beam angle: 25°
IP rate: IP20
Diameter: Ø111 mm
Height: 38 mm
Connection type: Stripped wire



ART. NR.	POWER	LUMINOUS FLUX	COLOR TEMP. (CCT)	LIGHT COLOR	DIMMABLE
175-299	7 Watt	n/a	n/a	🌈 RGB	Yes



LED Tubes & Lamps | Bulbs

G45 LED LAMP DECO

Input voltage: 220-240V
Power: 1 Watt
LED type: DIP
Dimmable: No
Beam angle: 190°
IP Rate: IP20
Length: 69 mm
Diameter: Ø 45 mm
Connection type: E27
Housing: Clear + PC



ART. NR.	POWER	LUMINOUS FLUX	COLOR TEMP. (CCT)	LIGHT COLOR
165-000	1 Watt	51 Lm	2400K	○ Warm white+

LED P45 | 1 WATT | PC CAP

Input voltage: 220-240V
Power: 1 Watt
LED type: SMD
Dimmable: No
Beam angle: 190°
IP rate: IP20 (IP44 when mounted in Tronix Festoon cable light)
LED type: SMD
Connection type: E27
Housing: PC



ART. NR.	POWER	LUMINOUS FLUX	COLOR TEMP.	LIGHT COLOR
165-031	1 Watt	62 Lm	Cold white	○ 6000K
165-038	1 Watt	50 Lm	Warm white	○ 2700K
165-032	1 Watt	n.a.	Blue	● n.a.
165-033	1 Watt	n.a.	Green	● n.a.
165-034	1 Watt	n.a.	Red	● n.a.
165-035	1 Watt	n.a.	Yellow	● n.a.
165-036	1 Watt	n.a.	Orange	● n.a.

Corn Lamps | LED Tubes & Lamps

CORN LED LAMP | 18 WATT

In 3000K or 5000K



Input voltage: 100-240V
Power: 18 Watt
LED type: SMD
Dimmable: No
Beam angle: 360°
IP rate: IP64
Diameter: Ø 64 mm
Length: 187 mm
Connection type: E27



ART. NR.	POWER	LUMINOUS FLUX	COLOR TEMP. (CCT)	LIGHT COLOR
175-536	18 Watt	2340 Lm	3000K	● Warm white
175-537	18 Watt	2340 Lm	5000K	○ Cold white

CORN LED LAMP | 26 WATT

In 3000K or 5000K



Input voltage: 100-240V
Power: 26 Watt
LED type: SMD
Dimmable: No
Beam angle: 360°
IP rate: IP64
Diameter: Ø 64 mm
Length: 207 mm
Connection type: E27



ART. NR.	POWER	LUMINOUS FLUX	COLOR TEMP. (CCT)	LIGHT COLOR
175-538	26 Watt	3380 Lm	3000K	● Warm white
175-539	26 Watt	3380 Lm	5000K	○ Cold white

Corn lamps E27 in 18W/26W in 3000K or 5000K

Effective outdoor lighting

LED Tubes & Lamps | LED Tubes

LED Tube T8 | 120/150 CM | MAGNETIC-BALLAST

LED Tubes for T8 fixtures with an magnetic ballast

Input voltage: 100-240V
Power: 18/25 Watt
Power factor: >0.9
LED type: SMD2835
Dimmable: No
Beam angle: 140°
Lifetime: 50.000 hours

CRI value: >80
IP Rate: IP20
Diameter: Ø 25,4 mm
Connection type: G13
Housing: Aluminium + PC



ART. NR.	LENGTH	POWER	LUMINOUS FLUX	COLOR TEMP.	COLOR CODE	LIGHT COLOR
177-125	120 cm	18 Watt	2700 Lm	2700K	827	● Warm white+
177-124	120 cm	18 Watt	2880 Lm	4000K	840	○ Natural white
177-123	150 cm	25 Watt	4000 Lm	4000K	840	○ Natural white

LED TUBE T8 | 60 CM | ELECTRICAL-BALLAST

LED tubes for T8 fixtures with an electronic ballast

Input voltage: 100-240V
Power: 9/18/20/25 Watt
Power factor: >0.9
LED type: SMD2835
Dimmable: No
Beam angle: 140°
Lifetime: 50.000 hours
CRI value: >80

IP Rate: IP20
Diameter: Ø 26 mm
Connection type: G13
Housing: Aluminium + PC



ART. NR.	LENGTH	POWER	LUMINOUS FLUX	COLOR TEMP.	COLOR CODE	LIGHT COLOR
177-105	60 cm	9 Watt	1350 Lm	3000K	830	● Warm white
177-099	60 cm	9 Watt	1350 Lm	4000K	840	○ Natural white
177-106	120 cm	18 Watt	3000 Lm	3000K	830	● Warm white
177-100	120 cm	20 Watt	3000 Lm	4000K	840	○ Natural white
177-107	150 cm	25 Watt	3750 Lm	3000K	835	● Warm white
177-101	150 cm	25 Watt	3750 Lm	4000K	840	○ Natural white
177-110	150 cm	25 Watt	3750 Lm	6000K	860	● Cold white
177-102	150 cm	25 Watt	3250 Lm	6500K	965	○ Cold white

LED Tube T5 | 150 CM | MAGNETIC BALLAST

LED Tubes for T5 fixtures with an magnetic ballast

Input voltage: 100-240V
Power: 30 Watt
Power factor: >0.95
LED type: SMD2835
Dimmable: No
Beam angle: 140°
Lifetime: 50.000 hours

CRI value: >80
IP Rate: IP20
Diameter: Ø 22 mm
Connection type: G5
Housing: Aluminium + PC



ART. NR.	LENGTH	POWER	LUMINOUS FLUX	COLOR TEMP.	COLOR CODE	LIGHT COLOR
177-200	150 cm	30 Watt	4800 Lm	4000K	840	○ Natural white

LED Tubes | LED Tubes & Lamps

LED T5 | SURFACE | 60/120 CM | TRI-WHITE

Fixture with CCT switch for pre-settable color temperature 3000K - 4000K - 5700K.
Easy connectable upto 750W.



Input voltage: 200-240V

Power: 8/18 Watt

Beam angle: 160°

IP Rate: IP42

Max. to connect: 750 Watt

Width: 22,3 mm

Height: 37,4

Connection Type: Male

Power cable: Excluding 177-068/069 (one Power cable for max. 750W)

Cover: PC white (RAL9016)

Accessories included: Mounting brackets for wall/ceiling, 1x connector



ART. NR.	POWER	LUMINOUS FLUX	COLOR TEMP. (CCT)	LIGHT COLOR	LENGTH
177-061	8 Watt	866-974-937 Lm	3000K/4000K/5700K	Warm white/Natural white/Cold white	60 cm
177-062	18 Watt	1937-2203-2099 Lm	3000K/4000K/5700K	Warm white/Natural white/Cold white	120 cm



INCLUDING SHORT CONNECTOR



OPTIONALLY LONGER CONNECTOR



EVERY FIXTURE COMES WITH ON/OFF SWITCH

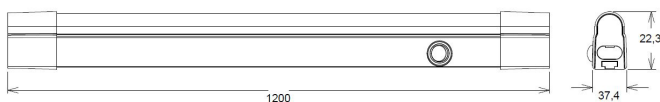
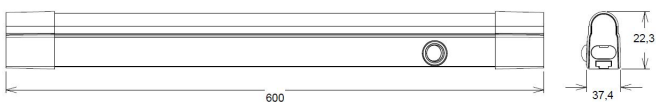

ART. NR. ACCESSORIES

170-065 Connector cable for LED T5 | 15cm

177-068 Power cable for LED T5 | 60CM

177-069 Power cable for LED T5 | 500CM



7

Emergency Lights

Setting best standards for
escape route illumination



Emergency Lights | Exit Signs

EMERGENCY BULK HEAD | 3W | AUTO TEST

With automatically periodic testing of the light source, electronics and battery



Input voltage: 220-240V
Power: 3 Watt
LED type: SMD2835
IP rate: IP65
Operating time: min. 3 hrs
Pictogram: 8x included
Connection type: Terminal block
Material: PC/Clear cover



ART. NR.	MOUNTING	POWER	LUMINOUS FLUX	COLOR TEMP. (CCT)	SIZE (L X W X H)
600-021	Surface	3 Watt	200 Lm	5000K	340 x 61,8 x 105 mm



*Pictograms included

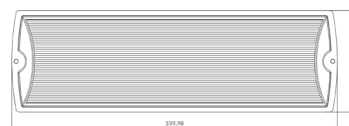

Auto test - Automatic testing - IEC 62034



Autotest is a function that provides emergency lighting for automatic periodic testing of the light source, electronics and battery. This is a protocol that complies with the international standard IEC 62034.

1. Test after commissioning: Takes place as soon as the luminaire is connected for the first time. The batteries are charging for 24 hours; after 24 hours a full autonomy test takes place. After that, the batteries are recharging again for 24 hours.
2. Short function test: for 3 seconds the luminaire tests (after pressing and releasing the test button) the condition of battery, electronics and light source.
3. Monthly function test: automatic 3-minute monthly test.
4. Annual autonomy test: 3-hour automatic, annual, full autonomy test.

Auto test - Automatisch testen - IEC 62034

Autotest is de nieuwst ontwikkelde functie voor Tronix noodverlichting. Het voorziet noodverlichting automatisch periodieke testen van de lichtbron, elektronica en batterij, volgens een protocol dat voldoet aan de internationale norm IEC 62034.

1. Test na ingebruikname: vindt plaats zodra het armatuur voor het eerst met netspanning is verbonden. De batterij wordt 24 uur lang geladen, waarna een volledige autonomietest plaatsvindt. Daarna wordt de batterij opnieuw 24 uur geladen.
2. Korte functie test: gedurende 3 seconden test het armatuur (na het indrukken en loslaten van de testknop) de conditie van batterij, elektronica en lichtbron.
3. Maandelijks functie test: automatische maandelijks test van 3 minuten.
4. Jaarlijkse autonome test: automatische, jaarlijkse, volledige autonome test van 3 uur.

Exit Signs | Emergency Lights

LED EXIT SIGN | SURFACE | WALL & CEILING AUTO TEST

With automatically periodic testing of the light source, electronics and battery.



- Input voltage:** 220-240V
- Power:** 1 Watt
- LED type:** SMD2835
- Luminous flux:** 35 Lm
- IP rate:** IP20
- Operating time:** min. 3 hrs
- Pictogram:** 9x included
- Connection type:** Terminal block
- Material:** Metal/steel housing with acrylic double sided legend panel



*Wall & ceiling mounting



*Pictograms included



ART. NR.	MOUNTING	POWER	LUMINOUS FLUX	COLOR TEMP. (CCT)	SIZE (L X W X H)
600-022	Surface	1 Watt	35 Lm	5000K	315 x 223 x 45 mm

ACCESSORIES

ART. NR.	MOUNTING	HOUSING COLOR	SIZE	MOUNTING HOLE	MOUNTING HEIGHT
600-030	Recessed	○ White	385 x 80 x 52 mm	360 x 55 mm	75 mm
600-032	Recessed	● Black	385 x 80 x 52 mm	360 x 55 mm	75 mm
600-031	Pendant	○ White	200 x 25 x 10 mm	n/a	1.5 m (max pendant height)

COMBINATIONS

MOUNTING	ART.NR.
Surface ceiling mounted	600-022
Surface wall mounted	600-022
Recessed ceiling mounted	600-022 + 600-030/600-032
Pendant mounted	600-022 + 600-031

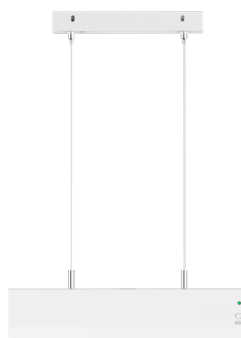

Art. nr. 600-031 Pendant kit

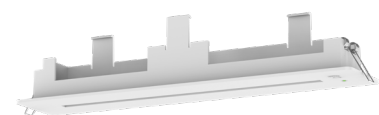

Art. nr. 600-030 Recessed mounting kit | white

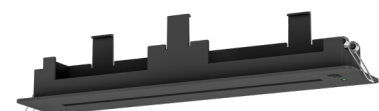

Art. nr. 600-032 Recessed mounting kit | black

Emergency Lights | Exit Signs

LED EXIT SIGN | WALL MOUNT | AUTO TEST

Included pictograms up, down, left, up-right, down-right. With automatically periodic testing of the light source, electronics and battery.



- Input voltage:** 220-240V
- Power:** 1 Watt (exit). 0,5 Watt (light)
- LED type:** SMD3014
- Luminous flux:** 35 Lm
- IP rate:** IP40
- Operating time:** min. 3 hrs
- Pictogram:** 5x included
- Connection type:** Terminal block
- Material:** PC/Clear cover



ART. NR.	MOUNTING	POWER	HOUSING COLOR	COLOR TEMP. (CCT)	SIZE (L X W X H)
600-019	Surface	5 Watt	● Black	5000K	330 x 190 x 45 mm
600-020	Surface	5 Watt	○ White	5000K	330 x 190 x 45 mm

*Pictograms included

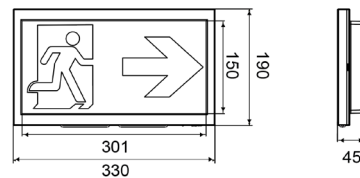
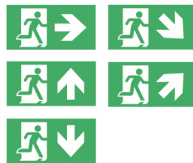

*In maintained mode, only the pictogram is illuminated (38 Lm). When emergency is detected, emergency mode will switch on. The two LED's provides 50 Lm lighting at the bottom of the fixture, useful for extra lighting in the escape route.

Exit Signs | Emergency Lights

LED EXIT SIGN LARGE | SINGLE | AUTO TEST

Extra large Exit sign with 70 meter viewing distance, designed for big areas such as warehouses or airports. With automatically periodic testing of the light source, electronics and battery.



- Input voltage:** 220-240V
- Power:** 10/20 Watt
- LED type:** SMD2835
- Luminous flux:** Single 264 Lm, Double 528 Lm
- IP rate:** IP20
- Operating time:** min. 3 hrs
- Pictogram:** Single 8x, Double 9x included
- Connection type:** Terminal block
- Material:** Aluminium / PMMA

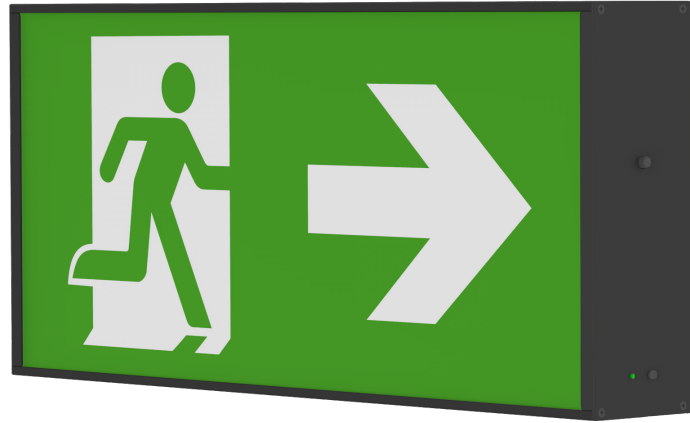

ART. NR.	TYPE	MOUNTING	POWER	COLOR TEMP. (CCT)	SIZE (L X W X H)	PICTOGRAM
600-039	Single	Wall, ceiling	10 Watt	6000K	744 x 363 x 90 mm	8 x
600-040	Double	Ceiling, pendant	20 Watt	6000K	744 x 363 x 90 mm	9 x (1x empty excluded)

*Single: Wall or ceiling



*Pictograms included



*Single: Ceiling or pendant (included)

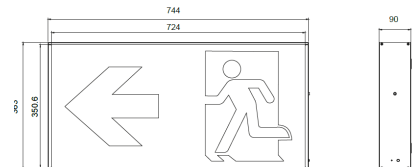

Emergency Lights | Luminaires

EMERGENCY DOWNLIGHT | 3W | Ø140MM BLACK & WHITE | AUTO TEST

Including two optional lenses (round&oval). With automatically periodic testing of the light source, electronics and battery. For surface or recessed mounting. with interchangeable lens. Round for square spaces. Oval for narrow long spaces such as hallways.

Input voltage: 220-240V

Power: 3 Watt

Beam angle: 150° (round), 65° x 160° (oval)

IP rate: IP20

Operating time: min. 3 hrs (internal battery)

Connection type: Screw

Material: PC housing



ART. NR.	HOUSING COLOR	MOUNTING	POWER	LUMINOUS FLUX	COLOR TEMP. (CCT)	DIAMETER	MOUNTING HOLE	(MOUNTING) HEIGHT
600-026	● Black	Surface	3 Watt	240 Lm	5000K	Ø 140 mm	-	61,55 mm
-	● Black	Recessed	3 Watt	240 Lm	5000K	-	Ø 112,5 mm	55,34 mm
600-025	○ White	Surface	3 Watt	240 Lm	5000K	Ø 140 mm	-	61,55 mm
-	○ White	Recessed	3 Watt	240 Lm	5000K	-	Ø 112,5 mm	55,34 mm

EMERGENCY DOWNLIGHT | 3W | Ø55-80MM BLACK & WHITE | AUTO TEST

Including two optional lenses (round&oval). With automatically periodic testing of the light source, electronics and battery. For recessed mounting. with interchangeable lens. Round for square spaces. Oval for narrow long spaces such as hallways.

Input voltage: 220-240V

Power: 3 Watt

Beam angle: 148° (round), 68° x 165° (oval)

IP rate: IP20

Operating time: min. 3 hrs (external battery)

Connection type: Screw

Material: PC housing

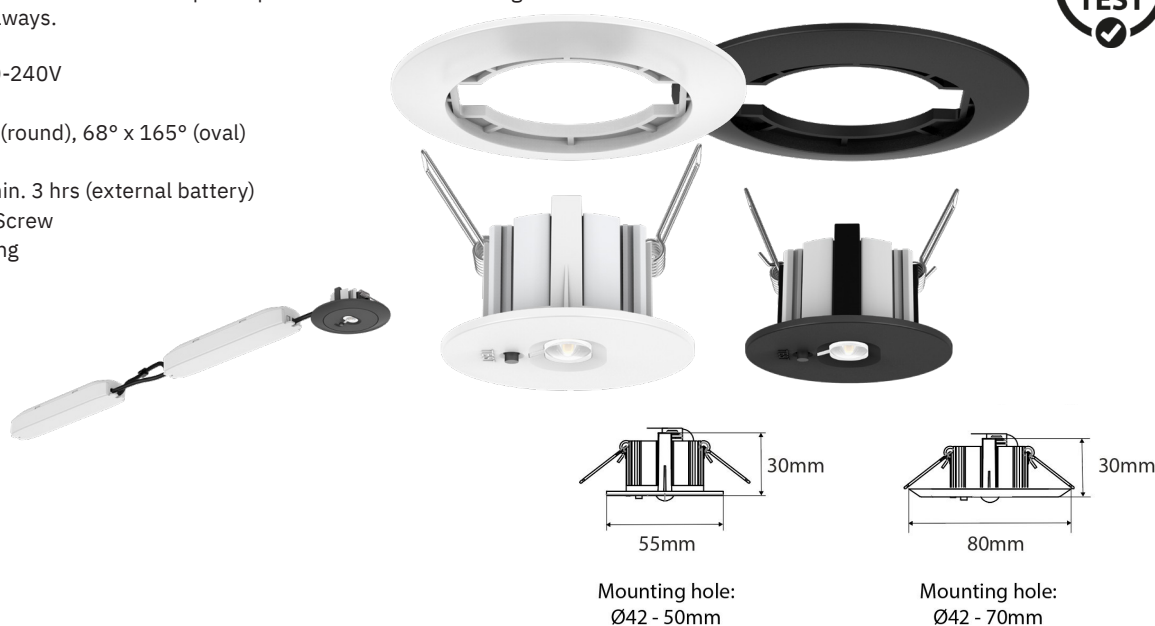

ART. NR.	HOUSING COLOR	MOUNTING	POWER	LUMINOUS FLUX	COLOR TEMP. (CCT)	DIAMETER	MOUNTING HOLE	(MOUNTING) HEIGHT
600-024	● Black	Recessed	3 Watt	240 Lm	5000K	Ø 55 mm	Ø 42-50 mm	30 mm
-	● Black	Recessed	3 Watt	240 Lm	5000K	Ø 80 mm	Ø 42-70 mm	30 mm
600-023	○ White	Recessed	3 Watt	240 Lm	5000K	Ø 55 mm	Ø 42-50 mm	30 mm
-	○ White	Recessed	3 Watt	240 Lm	5000K	Ø 80 mm	Ø 42-70 mm	30 mm

Luminaires | Emergency Lights

EMERGENCY DOWNLIGHT | 3W | 148X148 MM BLACK & WHITE | AUTO TEST



Including two optional lenses (round&oval). With automatically periodic testing of the light source, electronics and battery. For surface or recessed mounting. with interchangeable lens. Round for square spaces. Oval for narrow long spaces such as hallways.

- Input voltage:** 200-240V
- Power:** 3 Watt
- Beam angle:** 150° (round), 65° x 160° (oval)
- IP rate:** IP20
- Operating time:** min. 3 hrs (internal battery)
- Connection type:** Screw
- Material:** PC housing



ART. NR.	HOUSING COLOR	MOUNTING	POWER	LUMINOUS FLUX	COLOR TEMP. (CCT)	LENGTH	WIDTH	HEIGHT
600-029	● Black	Surface	3 Watt	220 Lm	5000K	148 mm	148 mm	33 mm
600-027	○ White	Surface	3 Watt	220 Lm	5000K	148 mm	148 mm	33 mm

LED EMERGENCY CEILING LIGHT | IP65 | BLACK & WHITE | TRI-WHITE



With CCT switch for pre-settable color temperature 3000K - 4000K - 5700K

- Input voltage:** 230V
- Power:** 15W
- Dimmable:** No
- Beam angle:** 110°
- IP rate:** IP65
- Operating time:** min. 3 hrs (emergency model)
- Connection type:** Terminal block
- Material:** PC



ART.NR.	HOUSING COLOR	MOUNTING	POWER	LUMINOUS FLUX	LIGHT COLOR	DIAMETER	HEIGHT	EMERGENCY
136-046	● Black	Surface	15W	1270-1420 Lm	Tri-white	Ø 300 mm	60 mm	Yes
136-045	● Black	Surface	15W	1270-1420 Lm	Tri-white	Ø 300 mm	60 mm	No
136-044	○ White	Surface	15W	1270-1420 Lm	Tri-white	Ø 300 mm	60 mm	Yes
136-043	○ White	Surface	15W	1270-1420 Lm	Tri-white	Ø 300 mm	60 mm	No

Emergency Lights | Luminaires

EMERGENCY LIGHT | 4W | IP65 | BLACK & WHITE AUTO TEST

With automatically periodic testing of the light source, electronics and battery. For surface mounting. The two light heads are independently adjustable.

Input voltage: 230V
Power: 4 Watt
Beam angle: 120°
IP rate: IP65
Operating time: min. 3 hrs (internal battery)
Connection type: Screw terminal
Material: PC housing

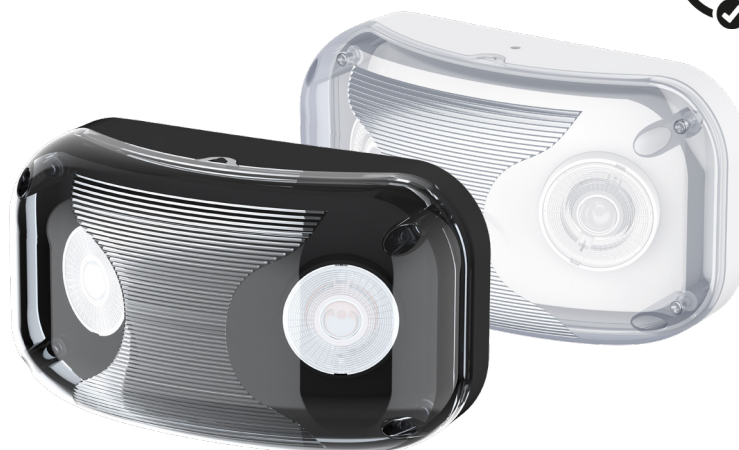

ART. NR.	HOUSING COLOR	MOUNTING	POWER	LUMINOUS FLUX	COLOR TEMP. (CCT)	LENGTH	WIDTH	HEIGHT
600-036	● Black	Surface	4 Watt	375 Lm	5000K	279 mm	127 mm	91 mm
600-035	○ White	Surface	4 Watt	375 Lm	5000K	279 mm	127 mm	91 mm

EMERGENCY LIGHT | 8W | BLACK & WHITE AUTO TEST

With automatically periodic testing of the light source, electronics and battery. For surface mounting. The two light heads are independently adjustable.

Input voltage: 220-240V
Power: 8 Watt
Beam angle: 120°
IP rate: IP20
Operating time: min. 3 hrs (internal battery)
Connection type: Screw terminal
Material: PC housing



ART. NR.	HOUSING COLOR	MOUNTING	POWER	LUMINOUS FLUX	COLOR TEMP. (CCT)	LENGTH	WIDTH	HEIGHT
600-038	● Black	Surface	8 Watt	1200 Lm	5000K	235 mm	130 mm	65 mm
600-037	○ White	Surface	8 Watt	1200 Lm	5000K	235 mm	130 mm	65 mm

Emergency Packs | Emergency Lights

LED EMERGENCY TRACK LIGHT | 1.7 | 70mA AUTO TEST

Can be directly connected on a 3-phase Track Rail. With automatically periodic testing of the light source, electronics and battery.

Input voltage: 220-240V

Power: 1.7W

Beam angle: 26°

IP rate: IP20

Operating time: min. 3 hrs (internal battery)

Connection type: 3-phase Track Rail

Material: PC



ART. NR.	HOUSING COLOR	MOUNTING	POWER	LUMINOUS FLUX	COLOR TEMP. (CCT)	LENGTH	WIDTH	HEIGHT
600-033	● Black	Surface	1.7 Watt	220 Lm	5000K	212 mm	63 mm	98 mm



*Emergency Light at office building, Art.nr. 600-022 with Recessed Mounting
Kit Black Art.nr 600-032, Poort van Uden - The Netherlands*

Packs & Accessories | Emergency Lights

LED EMERGENCY PACK | 10-60V | 70mA | AUTO TEST

To convert LED panels, downlights or other ceiling lights into luminaires with an emergency function.



Input voltage: 220-240V
Output current: Adjustable - 50/60/70 mA
Output voltage: 10-60V
Battery: Lipo 6,4V 3200mA

ART. NR.	SIZE	OPERATING TIME
600-028	145 x 36,8 x 23,5 mm	Min. 3 hrs

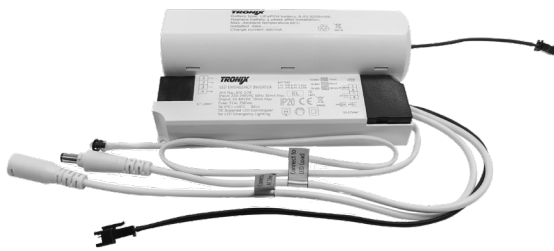

REPLACEMENT BATTERIES

Replacement Battery for Tronix Emergency Lights.



Type: Li-ion or LiPo
IP rate: IP20
Operating time: min. 3 hrs



ART. NR.	SUITABLE FOR	INCL. CASE	TYPE	VOLTAGE	CURRENT
600-100	600-022	No	LiPo	6.4V	600 mA
600-101	600-021, 600-023, 600-024	No	LiPo	6.4V	1500 mA
600-102	600-035, 600-036	No	Li-ion	3.7V	440 mA
600-103	600-028	Yes	LiPo	6.4V	3200 mA
600-104	600-025, 600-026, 600-033	No	LiPo	6.4V	1500 mA



8

High Bays

High savings with High Bay Lighting solutions for every warehouse





High Bays | ufo

UFO HIGH BAY | 80W~150W | 140 LM/W 5000K POWER/BEAM ADJUSTABLE

Pre-settable Power (DIP-switch) 80/100/120/150 Watt and Pre-settable beam angle 60°/80°/100° (lens rotatable).

Input voltage: 220-240V
Power: 80/100/120/150 Watt
Led type: SMD3030
Beam angle: 60° / 80° / 100°
CRI value: >70
IP rate: IP42
Cable length: 150 cm
Connection type: Schuko plug

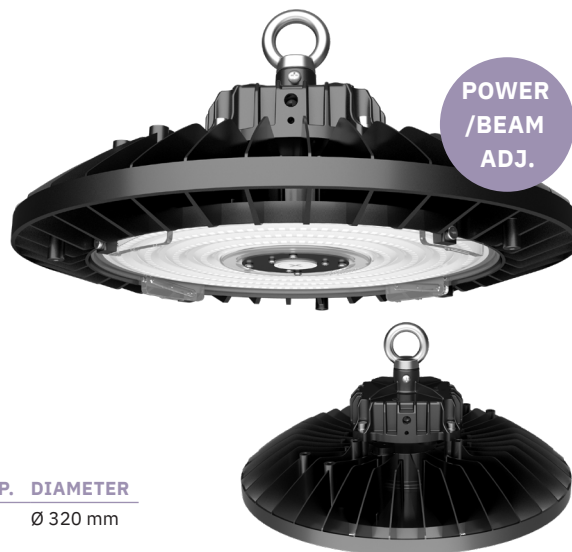
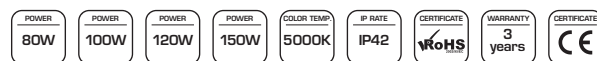

ART. NR.	POWER	LUMINOUS FLUX	BEAM ANGLE	COLOR TEMP.	DIAMETER
950-120	80/100/120/150W	21.000 Lm (max.)	60°/80°/100°	5000K	Ø 320 mm

UFO HIGH BAY | 190 Lm/W | 100W & 150W

High Lumen (190 Lm/W) High Bay with a 90° beam angle and a 120° optional lens available.

Input voltage: 100-240V
Power: 100/150 Watt
Led type: SMD2835
Beam angle: 90° (optional 120°)
CRI value: >70
IP rate: IP65
Cable length: 100 cm
Connection type: Schuko plug



ART. NR.	POWER	LUMINOUS FLUX	COLOR TEMP.	DIAMETER	HEIGHT (INCL. HOOK)
950-105	100 Watt	19.000 Lm	4000K	Ø 360 mm	186 mm
950-106	100 Watt	19.000 Lm	5000K	Ø 360 mm	186 mm
950-110	150 Watt	28.500 Lm	4000K	Ø 360 mm	186 mm
950-111	150 Watt	28.500 Lm	5000K	Ø 360 mm	186 mm

ART. NR. ACCESSORIES

- 950-112 Lens for UFO high bay | high luminous flux 190 Lm/W | 120°
- 950-113 Reflector for UFO high bay | high luminous flux 190 Lm/W | Black
- 950-114 Reflector for UFO high bay | high luminous flux 190 Lm/W | Acrylate



Art. nr. 950-113

Art. nr. 950-114





Tronix Ufo Highbay and Black Reflector (Art.nr 950-113) Intrax Oss - The Netherlands



Tronix Highbay (Art.nr 950-024) at Intratuin store Veghel - The Netherlands

50W | High Bays

HIGH BAY | 50W | 130 LM/W | 3000K NON DIMMABLE

White High Bay with aluminum housing and polycarbonate cover. Due to its white appearance, it is not only suitable for warehouses, but also for aesthetically demanding spaces.

Input voltage: 100-240V
Power: 50 Watt
Led type: SMD2835
Beam angle: 120°
CRI value: >80
IP rate: IP65
Cable length: 100 cm
Connection type: Schuko plug



ART. NR.	POWER	LUMINOUS FLUX	BEAM ANGLE	COLOR TEMP.	DIAMETER
950-024	50W	6500 Lm	120°	3000K	Ø 278 mm



9

Industrial Fixtures & Line Lighting

Meeting high expectations in
industrial lighting solutions



Industrial Fixtures & Line Lighting

INDUSTRIAL LIGHTBAR 150 CM | PRE-SETTABLE 40-50-60 WATT



With adjustable power switch 40/50/60 Watt and adjustable phase 1/2/3.

Input voltage: 100-240V
Power: 40/50/60 Watt (power switch on fixture)
Power Factor: >0.90
LED type: SMD2835
Beam angle: 120°
IP rate: IP65

IK rate: IK10
Connection type: Terminal block
Cover: PC Opal
Operating Environment: -20 +40 C°
Accessories included: 2x mounting clips and 2x M20 water proof connector
Wired: 3 Phase



ART.NR	POWER	LUMINOUS FLUX	COLOR.TEMP. (CCT)	LENGTH	WIDTH	HEIGHT	EMERGENCY
950-075	Preset 40-50-60 Watt	5300-6500-7800 Lm	4000K	1500 mm	85 mm	64 mm	No
950-076	Preset 40-50-60 Watt	5300-6500-7800 Lm	4000K	1500 mm	85 mm	64 mm	Yes



OPENS WITHOUT TOOLS



ADJUSTABLE POWER- AND PHASE SWITCH



FAST FIT AND ZERO MAINTENANCE

How many fixtures can be connected in one line?

max. 60 fixtures divided over 3 phases (3 x 20 fixtures)

ART. NR. ACCESSORIES

950-067 Pendant steel cable - 1 pc | 1,5M

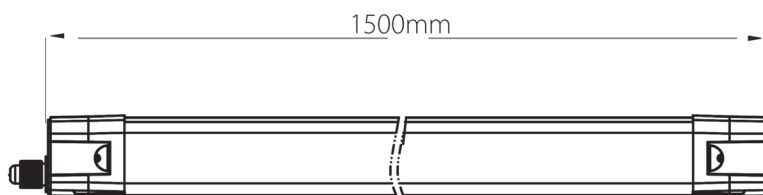
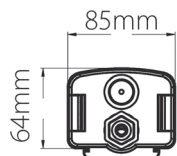

Industrial Fixtures & Line Lighting

TRI-PROOF LIGHT BAR

With single or double lightline. Buckle can be adjust to self-locking anti-theft mode.



- Input voltage:** 200-240V
- Power:** 10/19/38/57 Watt
- Power Factor:** >0,90
- LED type:** SMD
- Beam angle:** 120°
- CRI value:** >80
- IP Rate:** IP65
- IK Rate:** IK08
- Connection Type:** Screw Terminal inside
- Cover:** PC Opal
- Operating Environment:** -20°~45°
- Accessories included:** Mounting clip (2pcs) and cable gland (2pcs)



How many fixtures can be connected in one line?

Max. 35 fixtures

ART. NR. ACCESSORIES

950-090 Pendant Steel cable - 1 pc | 3M

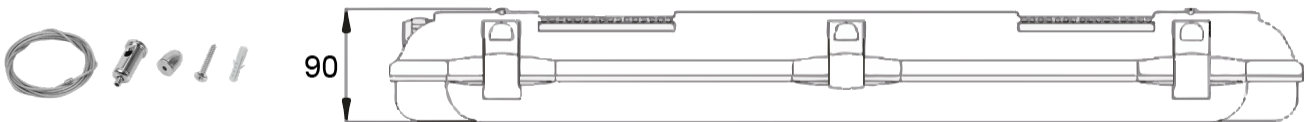

ART. NR.	POWER	LIGHT LINE	LUMINOUS FLUX	COLOR TEMP. (CCT)	LENGTH	WIDTH	HEIGHT
950-080	10 Watt	Single	1300 Lm	5000K	660 mm	90 mm	90 mm
950-081	19 Watt	Double	2470 Lm	5000K	664 mm	140 mm	90 mm
950-082	19 Watt	Single	2470 Lm	5000K	1274 mm	90 mm	90 mm
950-083	38 Watt	Double	4940 Lm	5000K	1274 mm	140 mm	90 mm
950-084	38 Watt	Single	4940 Lm	5000K	1574 mm	90 mm	90 mm
950-085	57 Watt	Double	7410 Lm	5000K	1574 mm	140 mm	90 mm

Industrial Fixtures & Line Lighting

TRI-PROOF LIGHTBAR | 1500MM | 45W | IP66 | 5000K

Ammonia resistant lightbar, ideal for car washes or agro industry. The fixtures can be connected upto 35 pieces and can be mounted with the two included clips.



Input voltage: 220-240V
Power: 45W
Dimmable: Yes
Beam angle: 140°
IP rate: IP66
IK rate: IK06
Connection type: Terminal block
Material: Aluminium & PC

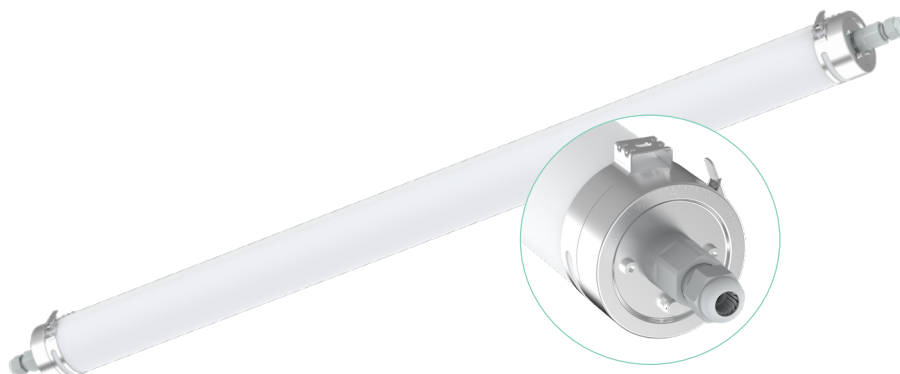

ART. NR.	POWER	LUMINOUS FLUX	LIGHT COLOR	LENGTH	DIAMETER
950-095	45 Watt	5000-5300 Lm	5000K	1500 mm	Ø75,2 mm

LED T5 | SURFACE | 60/120 CM | TRI-WHITE

With CCT switch for pre-settable color temperature 3000K/4000K/5700K



Input voltage: 200-240V
Power: 8/15 Watt
Dimmable: No
Beam angle: 160°
IP Rate: IP42
Connection Type: Male connector
Power cable: Excluding 177-068/177-069 (1x Power cable for max. 750W)
Material: PC white (RAL9001)
Accessories included: Mounting brackets for wall/ceiling, 1x connector

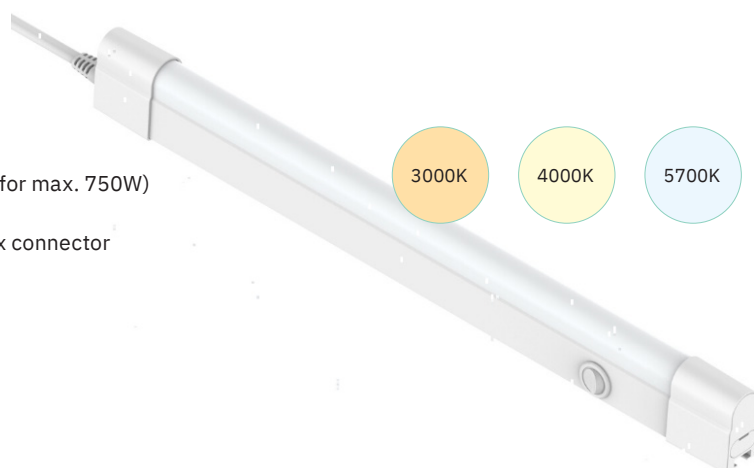

ART. NR.	POWER	LUMINOUS FLUX	LIGHT COLOR	LENGTH	WIDTH	HEIGHT
177-061	8 Watt	866-974-937 Lm	Tri-white	600 mm	22,3 mm	37,4 mm
177-062	18 Watt	1937-2203-2099 Lm	Tri-white	1200 mm	22,3 mm	37,4 mm

Industrial Fixtures & Line Lighting

BATTEN LIGHT | 20W/40W/10~25W | IP20 | TRI-WHITE

With CCT switch for pre-settable color temperature 3000K/4000K/5700K. Equipped with internal terminal block for wiring in and out. 10~25W: With DIP switch for pre-settable power.



Input voltage: 220-240V

Power: 20/40/10~25 Watt

Dimmable: No

Beam angle: 120°

IP rate: IP20

IK rate: IK08

Connection type: Terminal block

Material: Aluminium & PC



ART. NR.	POWER	LUMINOUS FLUX	LIGHT COLOR	LENGTH	WIDTH	HEIGHT
136-300	20 Watt	1800 - 2200 Lm	Tri-white	603 mm	71 mm	64 mm
136-301	40 Watt	4000 - 4600 Lm	Tri-white	1203 mm	71 mm	64 mm
136-305	10~25 Watt	1050 - 2500 Lm	Tri-white	600 mm	124 mm	68 mm

BATTEN LIGHT FLAT | 2 SIZES | 18W/30W | IP20 TRI-WHITE

With CCT switch for pre-settable color temperature 3000K - 4000K - 5700K.



Input voltage: 200-240V

Power: 18W/30W

Dimmable: No

Beam angle: 120°

Color temperature: 3000K/4000K/5700K

IP rate: IP20

IK rate: IK06

Connection type: Stripped wire

Power cable: 60 cm (on the back of the fixture)

Housing material: PC

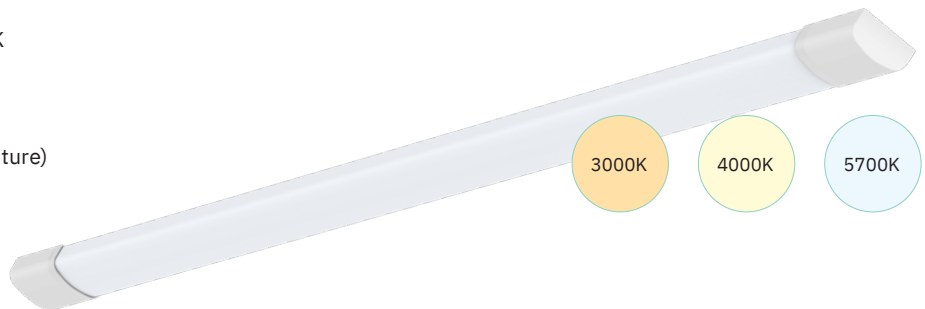

ART. NR.	POWER	LUMINOUS FLUX	LIGHT COLOR	LENGTH	WIDTH	HEIGHT
136-310	18 Watt	1450 - 1750 Lm	Tri-white	690 mm	56,5 mm	27,5 mm
136-311	30 Watt	3100 - 3400 Lm	Tri-white	1200 mm	56,5 mm	27,5 mm

Industrial Fixtures & Line Lighting

Why choose for Tronix Industrial LED Line-Lighting?

6500K

4000K

3000K

1. Simplicity

Tronix light lines can easily be connected by means of a toolless click-coupling system, enabling the realisation of light lines up to 100 meters long. Quick and easy assembly are guaranteed.



2. Savings up to 60%

With light performances up to 150 Lm per Watt, Tronix Industrial Light Lines realize savings of up to 60% compared to conventional light lines. This feature, ensuring a short return on investment period.



3. Control

Maintain control over use, consumption and savings by applying a light management system such as Dali, 1-10V and presence detection.



4. Flexibility

Offering a large choice in fixtures, both in performance and Beam angle, Tronix Industrial Light Lines are suitable for a wide variety of application areas, such as warehouses, workshops, production facilities, shops, and sports centres.

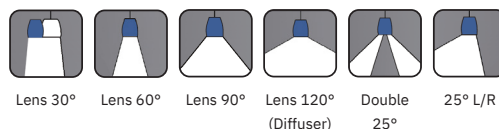

5. Total Solution

In addition to just plain delivery, Tronix Lighting also supports and advises in complete mounting and instalment, in close cooperation with our professional partners. This also includes the possibility of making light plans. National coverage, cost efficient and a single point of contact for the complete installation. In short, full customer support from A-Z.



LIMITED STOCK

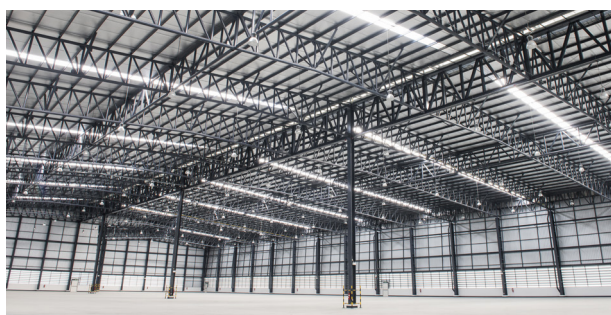

Tronix LED Line-Lighting System

Order on request - delivery time 4-6 weeks

Every project in the industrial area requires a custom-made approach with different requirements in color temperature, beam angle and dimming system. For this reason we maintain low standard stock of our Tronix LED Line-Lighting System so we can serve you best with maximum results.

Contact us so we can help and support you with custom-made advice. sales@tronixlighting.com | +31 (0)413 33 03 80

More info



Industrial Fixtures & Line Lighting

How does it work?

1. Choose Carrying profile

Carrying profiles for Tronix industrial light lines are available in 1.5 meters and 3 meters, and are equipped with a standard 7-wire cable 2.5 mm². They are suitable for 3-phase voltage in combination with dimming (1-10V or Dali) or emergency power lighting. Or optionally available with an 11-vein wiring for 3-phase voltage, in combination with both dimming (1-10V or Dali) and emergency lighting.

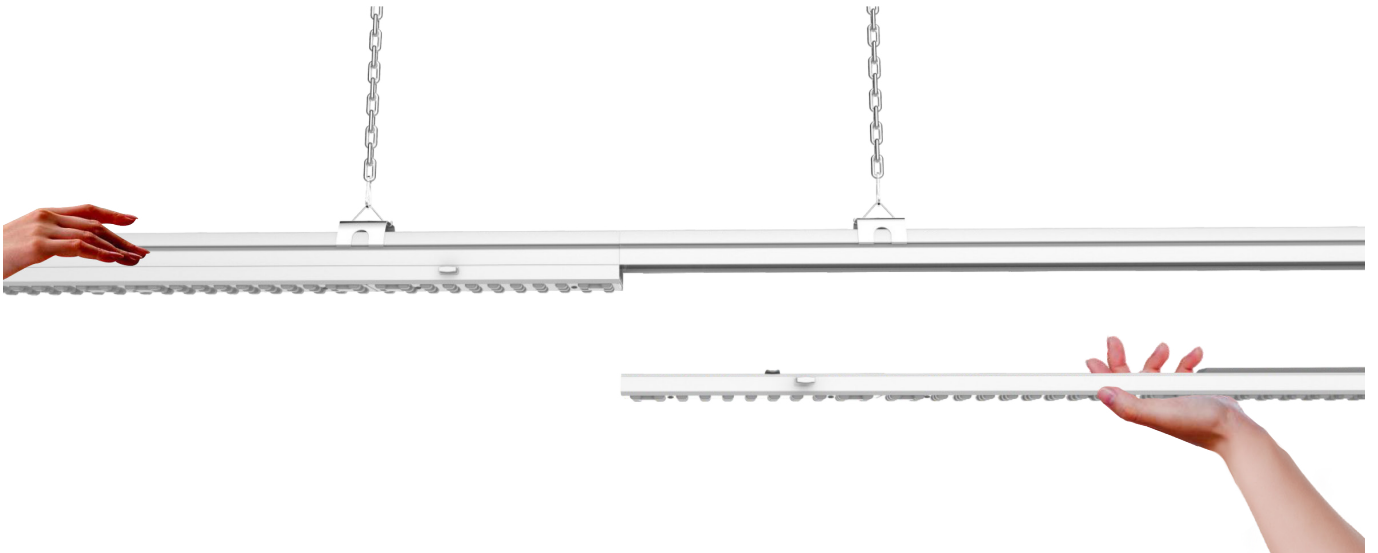

2. Choose LED module with optical lens

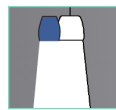

Lens 30°

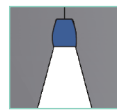

Lens 60°

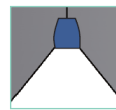

Lens 90°

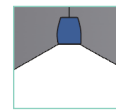

Lens 120°

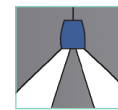

Double 25°

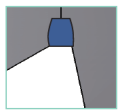

25° L/R

(Diffuser)

For all models (the 1-10V as well as the Dali dimmable versions), there is an optional model available with emergency function.



3. Choose Cover plate and accessories

Choose between a neutral cover plate or a neutral cover plate with a rail to combine with track spots. Accessories available like end sets, hang-up wires or extra power adaptors.

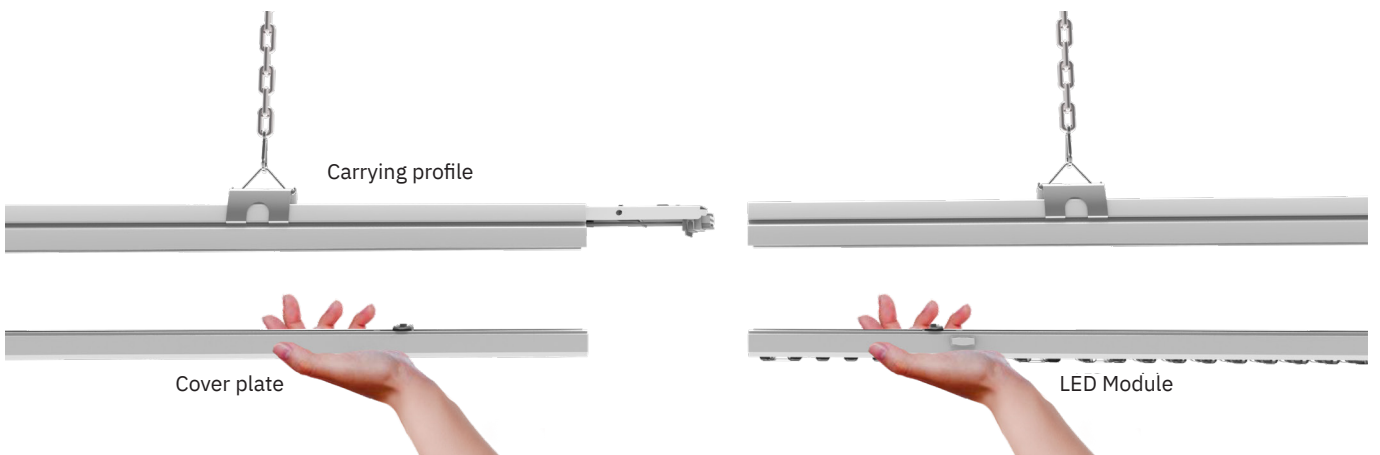

10 Floodlights

Powerful illumination of outdoor
areas, building facades or objects



HOUSE OF BEERS
REBELS IN DRINKS

Floodlights | ECO

FLOODLIGHT ECO | 10W/20W/30W/50W

Low entry Floodlight with Plug & Play connector for ECO sensors



Input voltage: 220-240 Volt
Power: 10/20/30/50 Watt
LED type: SMD2835
Dimmable: No
Beam angle: 100°
CRI value: >80
IP rate: IP65
Connection type: Schuko
Wire length: 150 cm
Housing: Aluminium
Finish: Black (powder coated)



ART. NR.	POWER	LUMINOUS FLUX	COLOR TEMP. (CCT)	WIDTH	HEIGHT	DEPTH
146-300	10 Watt	1000 Lm	● 3000K	132 mm	103 mm	30 mm
146-303	20 Watt	2000 Lm	● 3000K	160 mm	142 mm	30 mm
146-306	30 Watt	3000 Lm	● 3000K	195 mm	157 mm	35 mm
146-307	30 Watt	3000 Lm	○ 4000K	195 mm	157 mm	35 mm
146-309	50 Watt	5000 Lm	● 3000K	239 mm	165 mm	44 mm
146-310	50 Watt	5000 Lm	○ 4000K	239 mm	165 mm	44 mm
146-312	50 Watt	n/a	● Green	239 mm	165 mm	44 mm

ART. NR.	ACCESSORIES
146-318	Floodlight ECO Light Dark Sensor plug & play 10W to 50W
146-319	Floodlight ECO Motion Sensor plug & play 10W to 50W



Art.nr. 146-318



Art.nr. 146-319



*With Plug & Play connector for watertight connection of the motion or light/dark sensor.

PRO | Floodlights

FLOODLIGHT PRO | 50W/100W/200W/300W

With surge protection against peak voltages and external air pressure valve for air pressure regulation inside and outside (no moisture inside fixture).



- Input voltage:** 220-240 Volt
- Power:** 50/100/200/300 Watt
- LED type:** SMD3030
- Dimmable:** No
- Beam angle:** 120°
- CRI value:** >70
- IP rate:** IP66
- Connection type:** Schuko
- Wire length:** 150 cm
- Housing:** Aluminium
- Finish:** Black (powder coated)



ART. NR.	POWER	LUMINOUS FLUX	COLOR TEMP. (CCT)	WIDTH	HEIGHT	HEIGHT INCL. HANDLE	DEPTH
146-320	50 Watt	6.250 Lm	● 3000K	190 mm	200 mm	267 mm	55 mm
146-321	50 Watt	6.250 Lm	○ 4000K	190 mm	200 mm	267 mm	55 mm
146-334	100 Watt	12.500 Lm	● 2000K	230 mm	240 mm	314 mm	61 mm
146-330	100 Watt	12.500 Lm	● 3000K	230 mm	240 mm	314 mm	61 mm
146-331	100 Watt	12.500 Lm	○ 4000K	230 mm	240 mm	314 mm	61 mm
146-340	200 Watt	25.000 Lm	● 3000K	300 mm	305 mm	398 mm	70 mm
146-350	300 Watt	37.500 Lm	● 3000K	363 mm	370 mm	470 mm	80 mm
146-352	300 Watt	37.500 Lm	○ 5000K	363 mm	370 mm	470 mm	80 mm

ART.NR.	ACCESSORIES
146-327	Floodlight PRO Lens for 50W 60°
146-325	Floodlight PRO Lens for 50W Asymmetrical
146-329	Floodlight PRO Wall bracket 50W 1 meter
146-337	Floodlight PRO Lens for 100W 60°
146-335	Floodlight PRO Lens for 100W Asymmetrical
146-346	Floodlight PRO Lens for 200W 30°
146-347	Floodlight PRO Lens for 200W 60°
146-345	Floodlight PRO Lens for 200W Asymmetrical
146-356	Floodlight PRO Lens for 300W 30°
146-357	Floodlight PRO Lens for 300W 60°
146-355	Floodlight PRO Lens for 300W Asymmetrical
146-360	Floodlight PRO 60MM Pole mounting adapter
146-361	Floodlight PRO Pole clamp bracket



Art.nr. 146-360

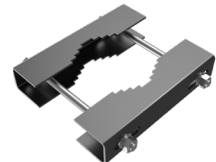

Art.nr. 146-361



Art.nr. 146-329

11

Area Lighting

For bright and powerful illumination of parking, retail or commercial areas or other general spaces



Office]

Area Lighting

PARKING LIGHT FIXTURE | E27 SOCKET

Excluding lamp



Input voltage: E27 Light Bulb (not included)

IP Rate: IP54

IK Rate: IK09

Connection Diameter: Ø 60 mm

Material: PET + Aluminium



ART. NR.	DIAMETER Ø	HEIGHT
220-040	590 mm	459 mm

CORN LAMP | E27

ART. NR.	POWER	LUMINOUS FLUX	COLOR TEMP. (CCT)
175-536	18 Watt	2340 Lm	3000K
175-537	18 Watt	2340 Lm	5000K
175-538	26 Watt	3380 Lm	3000K
175-539	26 Watt	3380 Lm	5000K

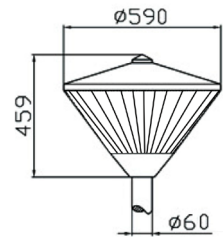

WALL PACK | 4000K | GREY RAL7024 | 20W | 40W

This wall pack has a slim design and is designed for a long service life without any maintenance



Input voltage: 100-240V

Power: 20/ 40 Watt

Beam angle: 100° x 120°

IP rate: IP66

Housing: Aluminium

Finish: Dark grey RAL7024

ART. NR.	POWER	LUMINOUS FLUX	COLOR TEMP.	LENGTH	WIDTH	HEIGHT
230-001	20W	2500 Lm	4000K	96 mm	196 mm	186 mm
230-004	40W	5000 Lm	4000K	125 mm	282 mm	205 mm



ART. NR. ACCESSORIES

230-009	Photocell Sensor for Wallpack Day/Night 10~20Lux on / 30~60 Lux off
---------	---





Tronix Wall-Pack (Art.nr. 230-004) at co-working space 't Handelshuys Uden - The Netherlands



Tronix Parking Light fixture (Art.nr. 220-040) at co-working space d'n Office Uden - The Netherlands

Parking Lights | Area Lighting

STREET LIGHT | 4000K | CREE LED PHILIPS DRIVER



With built-in surge protection, avoiding any possible damage caused by lightning or sudden electric pulses.

Input voltage: 220-240V
Power: 38/73/110/150 Watt
LED type: Cree LED XP-G3
Driver: Philips
Beam angle: 90°
IP rate: IP65
Connection diameter: 60 mm
Connection type: Terminal block
Housing: Aluminium
Finish: RAL7024



Art. nr. 220-050 - 220-051



Art. nr. 220-052 - 220-055



ADJUSTABLE ANGLE



USER FRIENDLY MAINTENANCE



EASY REMOVAL OF COMPONENTS

ART. NR.	POWER	LUMINOUS FLUX	COLOR TEMP. (CCT)	LED QTY	LENGTH	WIDTH	HEIGHT
220-050	38 Watt	4535 Lm	○ 4000K	16	472 mm	240 mm	100 mm
220-051	73 Watt	8924 Lm	○ 4000K	32	568 mm	240 mm	115 mm
220-052	110 Watt	13178 Lm	○ 4000K	48	762 mm	370 mm	130 mm
220-055	150 Watt	18391 Lm	○ 4000K	72	762 mm	370 mm	130 mm



Art. nr. 220-062



Art. nr. 220-080



Art. nr. 220-081

ART. NR. ACCESSORIES

- 220-062 LED Street Light | Mounting/Wall support 60mm | RAL7024
- 220-080 Street Light Acc. | Light Dark Switch at NEMA 3 Socket
- 220-081 Drill bit | 38 mm | For 220-080 Sensor

12

Garden Lights & Ground Spots

For attractive illumination of
gardens, patio's or driveways



Garden Lights & Spots | Ground Spots 220-240V

GROUND SPOT | 230V | 106MM | 9W

The beam angle of 36° is 22° projectable. Due to the PU cable, IK10 and anti-condensation valve, this spot is ideal for 'heavy' applications.



Input voltage: 230V
Power: 9 Watt
LED qty: 1 pc
LED type: CREE 1304
IP rate: IP67
IK rate: IK10

Connection type: Stripped wire
Wire length: 3 meter (PU, H07BQ-F)
Material: Stainless steel, Aluminium
Dimmable: Yes



ART. NR.	POWER	LUMINOUS FLUX	COLOR TEMP. (CCT)	LIGHT COLOR	BEAM	DIAMETER Ø	MOUNTING Ø	MOUNTING DEPTH
140-082	9 watt	687 Lm	2700K	● Warm white+	36°	106 mm	98 mm	151 mm
140-081	9 watt	687 Lm	3000K	○ Warm white	36°	106 mm	98 mm	151 mm

GROUND SPOT | 230V | 123MM | 16W

The beam angle of 38° is 22° projectable. Due to the PU cable, IK10 and anti-condensation valve, this spot is ideal for 'heavy' applications.



Input voltage: 230V
Power: 16 Watt
LED qty: 1 pc
LED type: CREE 1507
IP rate: IP67
IK rate: IK10

Connection type: Stripped wire
Wire length: 3 meter (PU, H07BQ-F)
Material: Stainless steel, Aluminium
Dimmable: Yes



ART. NR.	POWER	LUMINOUS FLUX	COLOR TEMP. (CCT)	LIGHT COLOR	BEAM	DIAMETER Ø	MOUNTING Ø	MOUNTING DEPTH
140-086	16 Watt	1084 Lm	2700K	● Warm white+	38°	123 mm	111 mm	177 mm
140-085	16 Watt	1084 Lm	3000K	○ Warm white	38°	123 mm	111 mm	177 mm

GROUND SPOT | 230V | 123MM | 23W

The beam angle of 38° is 22° projectable. Due to the PU cable, IK10 and anti-condensation valve, this spot is ideal for 'heavy' applications.



Input voltage: 230V
Power: 23 Watt
LED qty: 1 pc
LED type: CREE CXA1816
IP rate: IP67
IK rate: IK10

Connection type: Stripped wire
Wire length: 3 meter (PU, H07BQ-F)
Material: Stainless steel, Aluminium
Dimmable: Yes



ART. NR.	POWER	LUMINOUS FLUX	COLOR TEMP. (CCT)	LIGHT COLOR	BEAM	DIAMETER Ø	MOUNTING Ø	MOUNTING DEPTH
140-090	23 Watt	2200 Lm	2700K	● Warm white+	38°	123 mm	111 mm	177 mm
140-089	23 Watt	2200 Lm	3000K	○ Warm white	38°	123 mm	111 mm	177 mm

GROUND SPOT | 230V | 170MM | 28W

The beam angle of 40° is 22° projectable. Due to the PU cable, IK10 and anti-condensation valve, this spot is ideal for 'heavy' applications.



Input voltage: 230V
Power: 28 Watt
LED qty: 1 pc
LED type: CREE CXA2520
IP rate: IP67
IK rate: IK10

Connection type: Stripped wire
Wire length: 3 meter (PU, H07BQ-F)
Material: Stainless steel, Aluminium
Dimmable: Yes



ART. NR.	POWER	LUMINOUS FLUX	COLOR TEMP. (CCT)	LIGHT COLOR	BEAM	DIAMETER Ø	MOUNTING Ø	MOUNTING DEPTH
140-094	28 Watt	3298 Lm	2700K	● Warm white+	40°	170 mm	150 mm	233 mm
140-093	28 Watt	3298 Lm	3000K	○ Warm white	40°	170 mm	150 mm	233 mm

Ground Spots 24V | Garden Lights & Spots

GROUND SPOT | 24V | 42MM

IK08 Groundspot with stainless steel cover. Driver exluded, see Drivers & Controllers for 24V drivers.



Input voltage: 24V
Power: 2,4 Watt
LED qty: 1 pc
LED type: CREE XP
IP rate: IP67

IK rate: IK08
Connection type: Stripped wire
Wire length: 3 meter
Material: Stain steel 316, Alu
Dimmable: No



ART. NR.	POWER	LUMINOUS FLUX	COLOR TEMP. (CCT)	LIGHT COLOR	BEAM	COLOR RING	DIAMETER Ø	MOUNTING Ø	MOUNTING DEPTH
140-014	2,4 Watt	111 Lm	3000K	○ Warm white	120°	Grey	42 mm	39 mm	90 mm

GROUND SPOT | 24V | 55MM

IK08 Groundspot with aluminium cover. Driver exluded, see Drivers & Controllers for 24V drivers.



Input voltage: 24V
Power: 2,5 Watt
LED qty: 1 pc
LED type: CREE XP
IP rate: IP67

IK rate: IK08
Connection type: Stripped wire
Wire length: 3 meter
Material: Aluminium
Dimmable: No



ART. NR.	POWER	LUMINOUS FLUX	COLOR TEMP. (CCT)	LIGHT COLOR	BEAM	COLOR RING	DIAMETER Ø	MOUNTING Ø	MOUNTING DEPTH
140-012	2,5 Watt	111 Lm	3000K	○ Warm white	40°	Bronze	55 mm	42 mm	45 mm
140-013	2,5 Watt	111 Lm	3000K	○ Warm white	40°	Grey	55 mm	42 mm	45 mm

GROUND SPOT | 24V | 60MM

IK08 Groundspot with aluminium cover. Driver exluded, see Drivers & Controllers for 24V drivers.



Input voltage: 24V
Power: 2,4 Watt
LED qty: 1 pc
LED type: CREE XP
IP rate: IP67

IK rate: IK08
Connection type: Stripped wire
Wire length: 3 meter
Material: Aluminium
Dimmable: No



ART. NR.	POWER	LUMINOUS FLUX	COLOR TEMP. (CCT)	LIGHT COLOR	BEAM	COLOR RING	DIAMETER Ø	MOUNTING Ø	MOUNTING DEPTH
140-015	2,4 Watt	111 Lm	3000K	○ Warm white	120°	Grey	60 mm	41 mm	87 mm
140-016	2,4 Watt	111 Lm	3000K	○ Warm white	2 x 120°	Grey	60 mm	41 mm	87 mm

GROUND SPOT | 24V | 106MM

IK10 Groundspot with stainless steel ring. Driver exluded, see Drivers & Controllers for 24V drivers.



Input voltage: 24V
Power: 8,5 Watt
LED qty: 1 pc
LED type: CREE 1304
IP rate: IP67

IK rate: IK10
Connection type: Stripped wire
Wire length: 3 meter
Material: Stainless Steel + Alu Body
Dimmable: No



ART. NR.	POWER	LUMINOUS FLUX	COLOR TEMP. (CCT)	LIGHT COLOR	BEAM	COLOR RING	DIAMETER Ø	MOUNTING Ø	MOUNTING DEPTH
140-017	8,5 Watt	533 Lm	3000K	○ Warm white	36°	Grey	106 mm	98 mm	151 mm

Garden Lights & Spots | Ground Spots

GROUND SPOT | EMPTY HOUSING | Ø120MM

Empty housing with GU10 fitting and long PU-H07BQF cable for intensive and heavy use. GU10 Spot excluded (max. 5W Spot due to installation height).



IP rate: IP67

IK rate: IK08

Connection type: Stripped wire

Wire length: 3 meters

Material: Stainless steel, Aluminium, Glass



ART. NR.	DIAMETER Ø	MOUNTING Ø	MOUNTING DEPTH	FITTING
140-040	152 mm	105 mm	88 mm	GU10

SUITABLE LAMPS:



ACCESSORIES | CONNECTION TUBE 2 WAY / 3 WAY

For watertight connections



IP rate: IP65

Material: PC / RVS screws

ART. NR.	NR. OF OUTPUTS
142-007	1
142-006	2
142-011	2



142-007



142-006



142-011

Ground Spots | Garden Lights & Spots

GROUND SPOT | 100-240V | 145/195MM | 10,3/18,8W

With asymmetrical beam angle 25° x 53° and stainless steel cover.



Input voltage: 100-240V

Power: 10,3/18,8 Watt

LED type: CREE XP2

IP rate: IP67

IK rate: IK09

Connection type: Stripped wire

Wire length: 3 meter (rubber cable)

Material: Stainless steel, Aluminium

Dimmable: No



ART. NR.	POWER	LUMINOUS FLUX	COLOR TEMP. (CCT)	LIGHT COLOR	BEAM	DIAMETER Ø	MOUNTING Ø	MOUNTING DEPTH
140-074	10,3 Watt	700 Lm	3000K	○ Warm white	25° x 53°	145 mm	130 mm	91 mm
140-075	18,8 Watt	1300 Lm	3000K	○ Warm white	25° x 43°	195 mm	174 mm	111 mm

Groundspots and water drainage

Ground spots have a lot to endure outside so it is important to follow the guidelines below for maximum protection against water and dust.

- Install groundspots in a well draining subsoil
- Always install a ground spot on a flat or higher surface.
- Place the ground spot (with equipped pot) in a hole that leaves room for a 30-40 cm thick layer of gravel. This ensures faster draining after heavy rain fall and avoids the rising of groundwater.

Grondspots en waterafvoer

Grondspots hebben het buiten zwaar te verduren dus voor maximale bescherming tegen water en stof is het belangrijk om de volgende richtlijnen te volgen:

- Installeer grondspots altijd op een goed water doorlatende ondergrondlaag.
- Plaats grondspots altijd op een vlak of hoger oppervlak, nooit in een kuil.
- Plaats grondspots (incl. bijgeleverde kunststof kokor) in een gat dat onderin ruimte overlaat voor een grindlaag van 30-40 cm dik. Dit zorgt voor een snellere waterafvoer na zware regenval en voorkomt de stijging van grondwater.

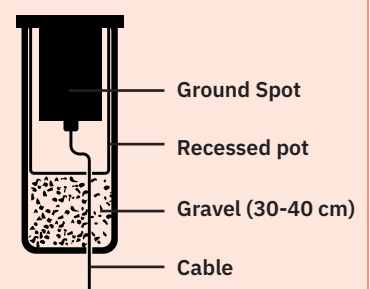

Garden Lights & Spots | Garden Spots

GARDEN SPOT | 40° | 2300K/2700K/3000K | 8W

Ideal for illuminate trees, facades, bushes or other outdoor objects.



Input voltage: 220-240V
Power: 8 Watt
LED qty: 3 pc
LED type: CREE XP-E2
IP rate: IP65

Connection type: Schuko plug
Wire length: 2 meter
Material: Aluminium
Dimmable: Yes



ART. NR.	POWER	LUMINOUS FLUX	BEAM	COLOR TEMP. (CCT)	LIGHT COLOR	SIZE LxWxH
149-356	8 Watt	521 Lm	40°	2300K	● Warm white++	104 x 67 x 92 mm
149-355	8 Watt	521 Lm	40°	2700K	● Warm white+	104 x 67 x 92 mm
149-350	8 Watt	521 Lm	40°	3000K	● Warm white	104 x 67 x 92 mm

GARDEN SPOT | 40° | 2700K/3000K | 10W

Ideal for illuminate trees, facades, bushes or other outdoor objects.



Input voltage: 220-240V
Power: 10 Watt
LED qty: 1 pc
LED type: CREE COB1507
IP rate: IP65

Connection type: Schuko plug
Wire length: 2 meter
Material: Aluminium
Dimmable: Yes



ART. NR.	POWER	LUMINOUS FLUX	BEAM	COLOR TEMP. (CCT)	LIGHT COLOR	SIZE LxWxH
149-358	10 Watt	909 Lm	40°	2700K	● Warm white+	123 x 79 x 117 mm
149-351	10 Watt	909 Lm	40°	3000K	● Warm white	123 x 79 x 117 mm

ACCESSORIES

ART. NR.	ACCESSORIES
149-352	Spike for Gardenspot 120 mm 149-350 & 149-351



Garden Spots | Garden Lights & Spots

GARDEN SPOT | 24V | 40° | 2,5W 2300K/2700K/3000K



Low voltage Garden Spot, ideal for safely illuminate trees, facades, bushes or other outdoor objects in public spaces.

Input voltage: 24V

Power: 2,5 Watt

LED qty: 1 pc

LED type: CREE XP-E2

IP rate: IP65

Connection type: Stripped wire

Wire length: 150 cm

Material: Aluminium

Dimmable: Yes



ART. NR.	POWER	LUMINOUS FLUX	BEAM	COLOR TEMP. (CCT)	LIGHT COLOR	SIZE (L X W X H)
149-403	2,5 Watt	179 Lm	40°	2300K	● Warm white++	68 x 58 x 68 mm
149-402	2,5 Watt	179 Lm	40°	2700K	● Warm white+	68 x 58 x 68 mm
149-401	2,5 Watt	179 Lm	40°	3000K	● Warm white	68 x 58 x 68 mm

ACCESSORIES

ART. NR.	ACCESSORIES
149-400	Spike for Gardenspot 24V 149-401, 149-402 & 149-403



Garden Lights & Spots | Garden Lights

WALL LAMP | CUBE | UP & DOWN | 6W DIMMABLE

With two independently adjustable beam angles (1° to 120°).

Input voltage: 220-240V

Power: 6 Watt

Dimming method: Triac

Beam angle: 2 x 1° to 120° (independently adjustable)

IP rate: IP65

Connection type: Terminal block

Housing material: Aluminium

Housing color: Black, white or grey (RAL7016)



ART.NR.	HOUSING COLOR	POWER	LUMINOUS FLUX	COLOR TEMP. (CCT)	LIGHT COLOR	SIZE (L X W X H)
149-138	● Black	6 Watt	2 x 110 Lm	2300K	● Warm white++	100 x 100 x 101 mm
149-139	○ White	6 Watt	2 x 110 Lm	2300K	● Warm white++	100 x 100 x 101 mm
149-134	● Grey	6 Watt	2 x 110 Lm	2300K	● Warm white++	100 x 100 x 101 mm
149-144	● Black	6 Watt	2 x 110 Lm	2700K	● Warm white+	100 x 100 x 101 mm
149-145	○ White	6 Watt	2 x 110 Lm	2700K	● Warm white+	100 x 100 x 101 mm
149-133	● Grey	6 Watt	2 x 110 Lm	2700K	● Warm white+	100 x 100 x 101 mm
149-142	● Black	6 Watt	2 x 110 Lm	3000K	○ Warm white	100 x 100 x 101 mm
149-143	○ White	6 Watt	2 x 110 Lm	3000K	○ Warm white	100 x 100 x 101 mm
149-132	● Grey	6 Watt	2 x 110 Lm	3000K	○ Warm white	100 x 100 x 101 mm

WALL LAMP | CUBE | UP & DOWN | 20W DIMMABLE

With two independently adjustable beam angles (1° to 120°).

Input voltage: 220-240V

Power: 20 Watt

Dimming method: Triac

Beam angle: 2 x 1° to 120° (independently adjustable)

IP rate: IP65

Connection type: Terminal block

Housing material: Aluminium

Housing color: Black



ART.NR.	HOUSING COLOR	POWER	LUMINOUS FLUX	COLOR TEMP. (CCT)	LIGHT COLOR	SIZE (L X W X H)
149-244	● Black	20 Watt	2 x 254 Lm	2700K	● Warm white+	200 x 100 x 101 mm
149-242	● Black	20 Watt	2 x 287 Lm	3000K	○ Warm white	200 x 100 x 101 mm

Garden Lights | Garden Lights & Spots

WALL LAMP | ROUND | UP & DOWN | 6W DIMMABLE



With two independently adjustable beam angles (1° to 120°).

Input voltage: 220-240V

Power: 6 Watt

Dimming method: Triac

Beam angle: 2 x 1° to 120° (independently adjustable)

IP rate: IP65

Connection type: Terminal block

Housing material: Aluminium

Housing color: Black or white



ART.NR.	HOUSING COLOR	POWER	LUMINOUS FLUX	COLOR TEMP. (CCT)	LIGHT COLOR	SIZE (L X W X H)
149-146	● Black	6 Watt	2 x 110 Lm	3000K	○ Warm white	136 x 115 x 100 mm
149-147	○ White	6 Watt	2 x 110 Lm	3000K	○ Warm white	136 x 115 x 100 mm
149-148	● Black	6 Watt	2 x 110 Lm	2700K	● Warm white+	136 x 115 x 100 mm
149-149	○ White	6 Watt	2 x 110 Lm	2700K	● Warm white+	136 x 115 x 100 mm

WALL LAMP | DOWNLIGHT | 5,8W | 2700K DIMMABLE



Pyramid shaped downlight with a beam angle of 36°.

Input voltage: 220-240V

Power: 5,8 Watt

Dimming method: Triac

Beam angle: 36°

IP rate: IP65

Connection type: Terminal block

Housing material: Aluminium

Housing color: Black



ART.NR.	HOUSING COLOR	POWER	LUMINOUS FLUX	COLOR TEMP. (CCT)	LIGHT COLOR	SIZE (L X W X H)
149-170	● Black	5,8 Watt	640 Lm	2700K	● Warm white+	143 x 90 x 90 mm

Garden Lights & Spots | Garden Lights

WALL LIGHT | UP- & DOWNLIGHT | 5,5W 3000K NON DIMMABLE

Up- and downlight with a beam angle of 25°

Input voltage: 220-240V
Power: 5,5 Watt
Dimmable: No
Beam angle: 25°
IP rate: IP65
Connection type: Terminal block
Housing material: Aluminium
Housing color: Black



ART.NR.	HOUSING COLOR	POWER	LUMINOUS FLUX	COLOR TEMP. (CCT)	LIGHT COLOR	SIZE (L X W X H)
149-160	● Black	5,5 Watt	2 x 161 Lm	3000K	○ Warm white	100 x 61 x 38 mm

WALL LIGHT | UP- & DOWNLIGHT | 2 SIZES DIMMABLE

Black or white up- and downlight in two sizes.

Input voltage: 220-240V
Power: 6,9/12,9 Watt
Dimming method: Triac
Beam angle: 90°
IP rate: IP54
Connection type: Terminal block
Housing material: Aluminium
Housing color: Black or white



ART.NR.	HOUSING COLOR	POWER	LUMINOUS FLUX	COLOR TEMP. (CCT)	LIGHT COLOR	SIZE (L X W X H)
149-150	● Black	6,9 Watt	2 x 346 Lm	2700K	○ Warm white+	115 x 90 x 28 mm
149-151	○ White	6,9 Watt	2 x 346 Lm	2700K	○ Warm white+	115 x 90 x 28 mm
	● Black	12,9 Watt	2 x 508 Lm	2700K	○ Warm white+	175 x 90 x 28 mm
149-156	○ White	12,9 Watt	2 x 508 Lm	2700K	○ Warm white+	175 x 90 x 28 mm



Tronix Wall Light Up- & Down Black (Art.nr. 149-155) at van Tienen Zeeland - The Netherlands

Garden Lights & Spots | Garden Lights

GARDEN LIGHT FIXTURE | 3000K

Combine the fixture (head-part) with a 20, 50 or 80 cm high aluminium lamp Post.



Input voltage: 220-240V
Power: 15 Watt
Dimming method: Triac
LED type: Cree CXA1512
Beam angle: 360°
IP rate: IP65
Diameter: Ø115 mm
Cable length: 150 cm (3x0,75)
Connection type: 2-PG9 connector
Material: Aluminium/PC



ART.NR.	POWER	LUMINOUS FLUX	COLOR TEMP. (CCT)	LIGHT COLOR	DIMMABLE
149-330	15 Watt	1425 Lm	3000K	○ Warm white	Yes (Triac)

LAMP POST

ART.NR.	HEIGHT
149-331	20 cm
149-332	50 cm
149-333	80 cm



*Including floor mounting ring and screws (inbus)



Art.nr. 149-331 with 149-330



Art.nr. 149-332 with 149-330



Art.nr. 149-333 with 149-330



Tronix Garden Light Fixture Art.nr. 149-333 with Art.nr. 149-330 at garden residence



Tronix Ground Spots illuminating a bamboo wall

Garden Lights | Garden Lights & Spots

WALL LIGHT | 7W | IP65 | 2700K-3000K

With CCT switch for pre-settable color temperature 2700K-3000K



Input voltage: 220-240V
Power: 7W
Dimmable: No
Beam angle: 120°
IP rate: IP65
IK rate: IK08
Connection type: Terminal block
Material: PC/Aluminium



ART.NR.	POWER	LUMINOUS FLUX	COLOR TEMP. (CCT)	LIGHT COLOR	SIZE (L X W X H)	DIMMABLE	MOTION SENSOR
136-240	7W	700 Lm	2700K-3000K	☉☉ Warm white+ warm white	251 x 167 x 80 mm	No	No
136-241	7W	700 Lm	2700K-3000K	☉☉ Warm white+ warm white	251 x 167 x 80 mm	No	Yes

WALL LIGHT | 3W | IP65 | 2700K-3000K

With CCT switch for pre-settable color temperature 2700K-3000K



Input voltage: 220-240V
Power: 3W/6W
Dimmable: No
Beam angle: 120°
IP rate: IP65
IK rate: IK06
Connection type: Terminal block
Material: PC



ART.NR.	POWER	LUMINOUS FLUX	COLOR TEMP. (CCT)	LIGHT COLOR	SIZE	DIMMABLE	MOTION SENSOR
136-250	3W	700 Lm	2700K-3000K	☉☉ Warm white+ warm white	Ø 125 mm	No	No
136-255	6W	700 Lm	2700K-3000K	☉☉ Warm white+ warm white	Ø 160 mm	No	No

Register

136-002	45	136-147	15	136-283	18	140-082	124
136-003	45	136-149	15	136-284	18	140-085	124
136-024	45	136-150	15	136-285	18	140-086	124
136-040	44	136-152	15	136-286	18	140-089	124
136-041	44	136-153	15	136-287	18	140-090	124
136-042	44	136-160	14	136-288	18	140-093	124
136-043	44	136-161	14	136-289	18	140-094	124
136-043	93	136-161	15	136-290	18	142-006	126
136-044	44	136-162	14	136-291	18	142-007	126
136-044	93	136-163	14	136-292	18	142-011	126
136-045	44	136-164	14	136-300	48	146-300	114
136-045	93	136-165	15	136-301	48	146-303	114
136-046	44	136-166	15	136-305	109	146-306	114
136-046	93	136-167	15	136-305	48	146-307	114
136-075	27	136-168	15	136-310	109	146-309	114
136-078	26	136-169	15	136-310	49	146-310	114
136-079	26	136-176	25	136-311	109	146-312	114
136-080	26	136-177	25	136-311	49	146-318	114
136-081	26	136-178	25	136-415	20	146-319	114
136-082	26	136-179	25	136-416	20	146-320	115
136-083	26	136-180	12	136-417	20	146-321	115
136-084	26	136-181	12	136-418	20	146-325	115
136-085	26	136-182	12	136-419	20	146-327	115
136-086	26	136-183	12	136-420	20	146-329	115
136-087	26	136-184	12	136-421	20	146-330	115
136-088	26	136-185	12	136-422	20	146-331	115
136-089	26	136-186	12	136-423	20	146-334	115
136-096	52	136-187	12	136-424	20	146-335	115
136-097	52	136-189	12	136-425	20	146-337	115
136-098	52	136-190	25	136-426	20	146-340	115
136-099	52	136-191	25	136-427	21	146-345	115
136-101	25	136-195	23	136-428	21	146-346	115
136-102	25	136-196	23	136-429	21	146-347	115
136-103	25	136-197	23	136-430	21	146-350	115
136-104	25	136-198	23	136-431	21	146-352	115
136-105	25	136-221	45	136-432	21	146-355	115
136-106	25	136-231	53	136-433	21	146-356	115
136-107	25	136-232	53	136-434	21	146-357	115
136-108	25	136-240	137	136-435	21	146-360	115
136-112	22	136-240	46	136-436	21	146-361	115
136-115	22	136-241	137	136-437	21	148-026	75
136-118	22	136-241	46	136-438	21	148-027	75
136-121	22	136-250	137	138-001	58	148-028	75
136-122	13	136-250	46	138-011	58	148-030	75
136-124	13	136-255	137	140-012	125	148-031	75
136-125	13	136-255	46	140-013	125	148-032	75
136-126	13	136-275	19	140-014	125	148-033	75
136-127	13	136-276	19	140-015	125	148-034	75
136-128	13	136-277	19	140-016	125	148-035	75
136-140	15	136-278	19	140-017	125	148-036	75
136-141	15	136-279	19	140-040	126	148-037	75
136-143	15	136-280	19	140-074	127	148-038	75
136-144	15	136-281	18	140-075	127	148-043	70
136-146	15	136-282	18	140-081	124	148-044	70



Register

148-045	70	149-143	55	169-006	66	169-118	67
148-046	70	149-144	130	169-007	66	169-119	67
148-050	70	149-144	55	169-008	66	169-120	67
148-051	70	149-145	130	169-009	66	169-270	63
148-052	70	149-145	55	169-010	66	169-271	63
148-053	70	149-146	131	169-011	66	169-272	63
148-060	70	149-146	56	169-012	66	169-273	63
148-061	70	149-147	131	169-013	66	169-290	63
148-062	70	149-147	56	169-014	67	169-291	63
148-063	70	149-148	131	169-015	66	169-294	63
148-507	74	149-148	56	169-016	66	169-295	63
148-550	74	149-149	131	169-017	66	169-307	65
148-551	74	149-149	56	169-020	67	169-310	65
148-552	74	149-150	132	169-021	67	169-311	65
148-553	74	149-150	57	169-022	67	169-360	63
148-555	74	149-151	132	169-023	66	169-361	63
148-556	74	149-151	57	169-024	66	170-065	85
148-557	74	149-155	132	169-025	66	174-029	39
148-558	74	149-155	57	169-026	66	174-048	32
148-559	74	149-156	132	169-027	66	174-050	40
148-560	74	149-156	57	169-028	66	174-057	41
148-563	74	149-160	132	169-029	66	174-058	40
148-565	74	149-160	57	169-030	66	174-101	40
148-569	74	149-170	131	169-031	66	174-103	40
148-570	74	149-170	56	169-032	66	174-105	40
148-571	74	149-242	130	169-035	66	174-106	40
148-572	74	149-242	55	169-036	67	174-107	40
148-573	74	149-244	130	169-037	67	174-130	30
148-574	74	149-244	55	169-038	67	174-131	31
148-575	74	149-330	134	169-039	67	174-132	31
148-576	74	149-331	134	169-040	66	174-140	30
148-577	74	149-332	134	169-041	66	174-141	30
148-578	74	149-333	134	169-042	66	174-154	31
148-579	74	149-350	128	169-043	66	174-155	30
148-580	74	149-351	128	169-044	66	174-156	30
148-581	74	149-352	128	169-045	66	174-176	30
148-582	74	149-355	128	169-046	66	174-177	30
148-583	74	149-356	128	169-047	66	174-178	30
148-584	74	149-358	128	169-048	66	174-182	30
148-585	74	149-400	129	169-049	66	174-183	30
148-586	74	149-401	129	169-072	66	174-184	30
149-132	130	149-402	129	169-073	67	174-185	30
149-132	55	149-403	129	169-074	67	174-186	30
149-133	130	165-000	82	169-101	66	174-187	30
149-133	55	165-031	82	169-102	66	174-188	30
149-134	130	165-032	82	169-103	66	174-189	30
149-134	55	165-033	82	169-104	66	174-190	30
149-138	130	165-034	82	169-105	66	174-191	30
149-138	55	165-035	82	169-106	66	174-192	30
149-139	130	165-036	82	169-107	67	174-193	30
149-139	55	165-038	82	169-108	67	174-194	31
149-142	130	169-002	67	169-109	67	174-195	31
149-142	55	169-003	67	169-112	67	174-196	31
149-143	130	169-005	66	169-113	67	174-197	31

Register

174-198	31	174-323	17	177-101	84	595-036	41
174-199	31	174-324	17	177-102	84	595-037	41
174-204	38	174-326	17	177-105	84	595-038	41
174-205	38	174-327	17	177-106	84	595-039	41
174-208	31	174-330	17	177-107	84	595-040	41
174-209	31	174-331	17	177-110	84	600-019	90
174-210	31	174-332	17	177-123	84	600-020	90
174-211	38	174-700	40	177-124	84	600-021	88
174-212	38	174-701	40	177-125	84	600-022	89
174-213	38	174-731	31	177-200	84	600-023	92
174-214	38	174-740	30	177-300	109	600-024	92
174-215	38	174-741	30	177-301	109	600-025	92
174-216	38	174-754	31	179-002	51	600-026	92
174-221	31	174-755	30	179-004	51	600-027	93
174-222	31	174-756	30	179-022	51	600-028	41
174-223	31	174-821	31	179-024	51	600-028	97
174-224	31	174-822	31	179-050	51	600-029	93
174-225	31	175-137	78	179-060	51	600-030	89
174-226	31	175-138	79	179-061	51	600-031	89
174-227	31	175-142	79	179-080	51	600-032	89
174-228	31	175-143	79	179-081	51	600-033	67
174-229	31	175-144	79	179-082	51	600-033	95
174-230	31	175-154	79	214-051	41	600-035	94
174-231	31	175-299	81	214-142	32	600-036	94
174-232	31	175-316	81	214-143	32	600-037	94
174-233	30	175-323	81	214-159	34	600-038	94
174-234	30	175-324	81	214-167	34	600-039	91
174-235	30	175-343	80	214-172	34	600-040	91
174-236	30	175-344	80	214-175	34	600-100	97
174-237	39	175-347	80	215-265	22	600-101	97
174-240	32	175-350	80	215-266	22	600-102	97
174-241	33	175-370	80	215-267	22	600-103	97
174-242	32	175-372	80	215-280	22	600-104	97
174-250	34	175-536	118	215-281	22	950-024	103
174-255	34	175-536	83	215-282	22	950-067	106
174-270	37	175-537	118	215-380	22	950-075	106
174-271	37	175-537	83	215-509	22	950-076	106
174-275	37	175-538	118	215-517	22	950-080	107
174-276	37	175-538	83	220-040	118	950-081	107
174-300	16	175-539	118	220-050	121	950-082	107
174-301	16	175-539	83	220-051	121	950-083	107
174-303	16	175-550	78	220-052	121	950-084	107
174-304	16	175-570	78	220-055	121	950-085	107
174-306	16	177-061	108	220-062	121	950-090	107
174-307	16	177-061	49	220-080	121	950-095	108
174-309	16	177-061	85	220-081	121	950-105	100
174-310	16	177-062	108	230-001	118	950-106	100
174-315	16	177-062	49	230-004	118	950-110	100
174-316	16	177-062	85	230-009	118	950-111	100
174-317	16	177-068	85	595-030	41	950-112	100
174-318	16	177-069	85	595-033	41	950-113	100
174-320	17	177-099	84	595-034	41	950-114	100
174-321	17	177-100	84	595-035	41	950-120	100

