















BEAM TRACK LIGHT

art.	W	lm	K		Ø	L	L1		 8011905	
TB50L130-W	12		920	3000	15°	50	136	136	305	936884
TB50L140-W	12		990	4000	15°	50	136	136	305	936907
TB50L130-B	12		920	3000	15°	50	136	136	305	936891
TB50L140-B	12		990	4000	15°	50	136	136	305	936914
TB60L130-W	20		1700	3000	36°	60	148	146	394	936921
TB60L140-W	20		1800	4000	36°	60	148	146	394	936945
TB60L130-B	20		1700	3000	36°	60	148	146	394	936938
TB60L140-B	20		1800	4000	36°	60	148	146	394	936952
TB80L130-W	30		2500	3000	36°	80	189	166	673	936969
TB80L140-W	30		2700	4000	36°	80	189	166	673	936983
TB80L130-B	30		2500	3000	36°	80	189	166	673	936976
TB80L140-B	30		2700	4000	36°	80	189	166	673	936990

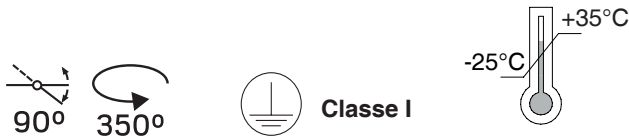
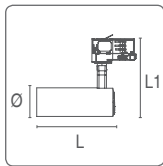

IP20 Adatto al funzionamento all'interno - Suitable for indoor use. 25°C

RG1 UNLIMITED RG1 secondo norma IEC/TR 62778:2014 / RG1 in accordance with IEC/TR 62778:2014
RG1 selon la norme IEC/TR 62778:2014 / RG1 nach der norm IEC/TR 62778:2014
RG1 enlight IEC/TR 62778:2014 / RG1 volgens IEC/TR 62778:2014
RG1 de acordo com norma IEC/TR 62778:2014

IT - L'apparecchio deve essere installato da personale qualificato. L'azienda declina ogni responsabilità qualora l'installazione non avvenga secondo le norme vigenti. Conservare l'etichetta dell'imballo originale per eventuali reclami futuri. Attenzione nell'area di prodotto del sito web - www.duralamp.it - potrebbe essere disponibile una versione più aggiornata del presente manuale.

EN - This fixture must be installed by a qualified electrician. DURALAMP is not responsible if its fixtures are not installed according to local safety standards. Keep the label of the original packaging for the eventual future claims. Attention in the product area of the website - www.duralamp.it - could be available one most updated version of this manual.

FR - L'appareil doit être installer par des électriciens qualifiés. DURALAMP ne peut être tenu responsable pour les installations qui ne respectent pas les normes de sécurité en vigueur. Garder l'étiquette de l'emballage original pour d'éventuelles réclamations futures. Attention, sur le site internet - www.duralamp.it -, dans la partie concernant ce produit une version plus récente de cette notice pourrait être disponible.

SP - El aparato debe ser instalado por electricistas cualificados. DURALAMP no se responsabilizara de todas las instalaciones que no respeten las normas da seguridad en vigor. Conservar la etiqueta del embalaje original para posibles reclamaciones.

D - as Gerät muss von Elektroinstallateuren montiert werden. DURALAMP ist nicht verantwortlich, wenn die Montage nicht gemäß der Sicherheitsvorschriften stattfindet. Die Etikette der Originalverpackung muss für eventuelle zukünftige Reklamationen aufbewahrt werden. Achtung, in der produktspalte www.duralamp.it koennte eine ueberarbeitete version dieser anleitung zur verfuegung stehen



IT - Note: Non smaltire apparecchi elettrici nei rifiuti urbani indifferenziati, usare le apposite strutture di raccolta differenziata. Contattare le amministrazioni locali per informazioni relative ai sistemi di raccolta disponibili. Se gli apparecchi elettrici subiscono opercolazione ed entrano nelle falde acquifere, entrano nella catena alimentare, danneggiando la salute e il benessere di tutti.



EN - Note: Do not dispose of electrical appliances as unsorted municipal waste, Use separate collection facilities. Contact you local government for Information regarding the collection systems available. If electrical appliances a re groundwater and get into the food chain, damaging your health and well-being.

IT - SI RACCOMANDA DI NON ELETTRIFICARE IL PRODOTTO IN FASE DI INSTALLAZIONE E PUNTAMENTO A BINARIO IN QUANTO SONO INTEGRATI ALIMENTATORI ELETTRONICI CHE POTREBBERO CAUSARE FENOMENI DI INRUSH CURRENT DANNOSI PER L'IMPIANTO.

! La sorgente luminosa di questo apparecchio non è sostituibile. Quando la sorgente luminosa raggiunge il fine vita deve essere sostituito l'intero apparecchio.

EN - NO ELECTRIFY THE TRACK SYSTEM DURING THE INSTALLATION AND SETTING OF THE PRODUCTS, THE INTEGRATED ELECTRONIC BALLASTS COULD CAUSE INRUSH CURRENT PHENOMENON THAT COULD IMPAIR WITH THE SAFETY OF THE ELECTRICAL POWER SYSTEM

! The light source of this device is not replaceable. When the light source reaches the end of its life the entire unit must be replaced.

FR - NE PAS INSTALLER OU RÉGLER LE PRODUIT AVEC L'ALIMENTATION RELIÉE AU RÉSEAU : LE PRODUIT EST FOURNI AVEC DES COMPOSANTS ÉLECTRONIQUES POUVANT CAUSER DES CHOCS ÉLECTRIQUES PENDANT LA MANIPULATION ET ENDOMMAGER L'ALIMENTATION ÉLECTRIQUE ET/OU L'APPAREIL.

! La source lumineuse de cet appareil ne peut pas être remplacée. Lorsque la source lumineuse atteint sa fin de vie, il faut remplacer l'intégralité de l'appareil

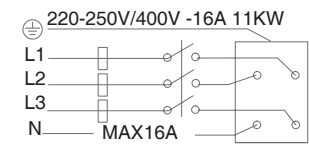
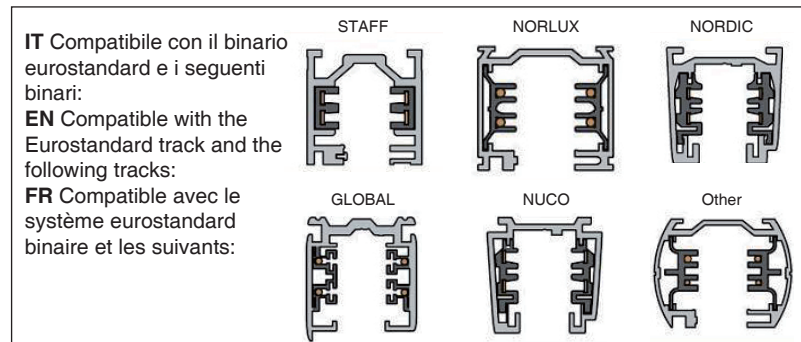

3 - PHASE

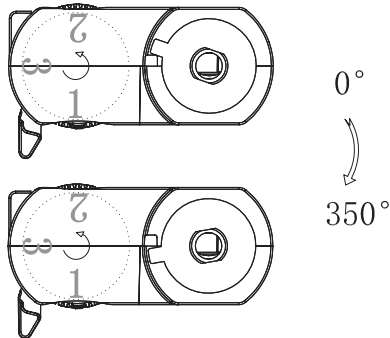

Installazione Installation Installation

