

## LED Post Top

Item Code	CCT	kg	Item Code	CCT	kg
543016005700	3000K	7.8kg	708000000100	3000K	7.8kg
543016005800	3000K	7.9kg	708000000200	3000K	7.9kg
543016005900	3000K	8.0kg	708000000300	3000K	8.0kg
543016006000	3000K	7.8kg	708000000400	3000K	7.8kg
543016006100	3000K	7.9kg	708000000500	3000K	7.9kg
543016006200	3000K	8.0kg	708000000600	3000K	8.0kg
543016006300	4000K	7.8kg	708000000700	4000K	7.8kg
543016006400	4000K	7.9kg	708000000800	4000K	7.9kg
543016006500	4000K	8.0kg	708000000900	4000K	8.0kg
543016006600	4000K	7.8kg	708000001000	4000K	7.8kg
543016006700	4000K	7.9kg	708000001100	4000K	7.9kg
543016006800	4000K	8.0kg	708000001200	4000K	8.0kg

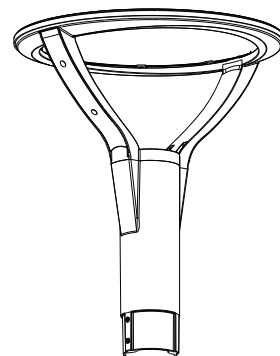

Model Name	Diameter (mm)	Ø (mm)	H (mm)	Rated Voltage(V~)	Frequency (Hz)	Current (A)	Rated Power(w)
LED PT-P1 33W	Spigot A: 60	450	565	220-240	50/60	0.75	33
LED PT-P1 50W						1.2	50
LED PT-P1 68W						1.6	68
LED PT-P1 33W D76	Spigot B: 76	450	565	220-240	50/60	0.75	33
LED PT-P1 50W D76						1.2	50
LED PT-P1 68W D76						1.6	68

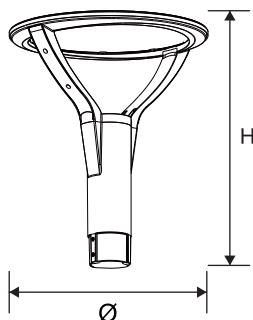

### Installation

①

M4  
1.2N.m

Application height: 3m - 6m

②

Put the connector back to the luminaire after wiring

L Brown  
 PE Yellow/green  
 N Blue

Ø7-Ø10

L  
 PE  
 N

5mm 20mm

External Wire Diameter: Min:3×1.0mm<sup>2</sup>  
Max:3×1.5mm<sup>2</sup>

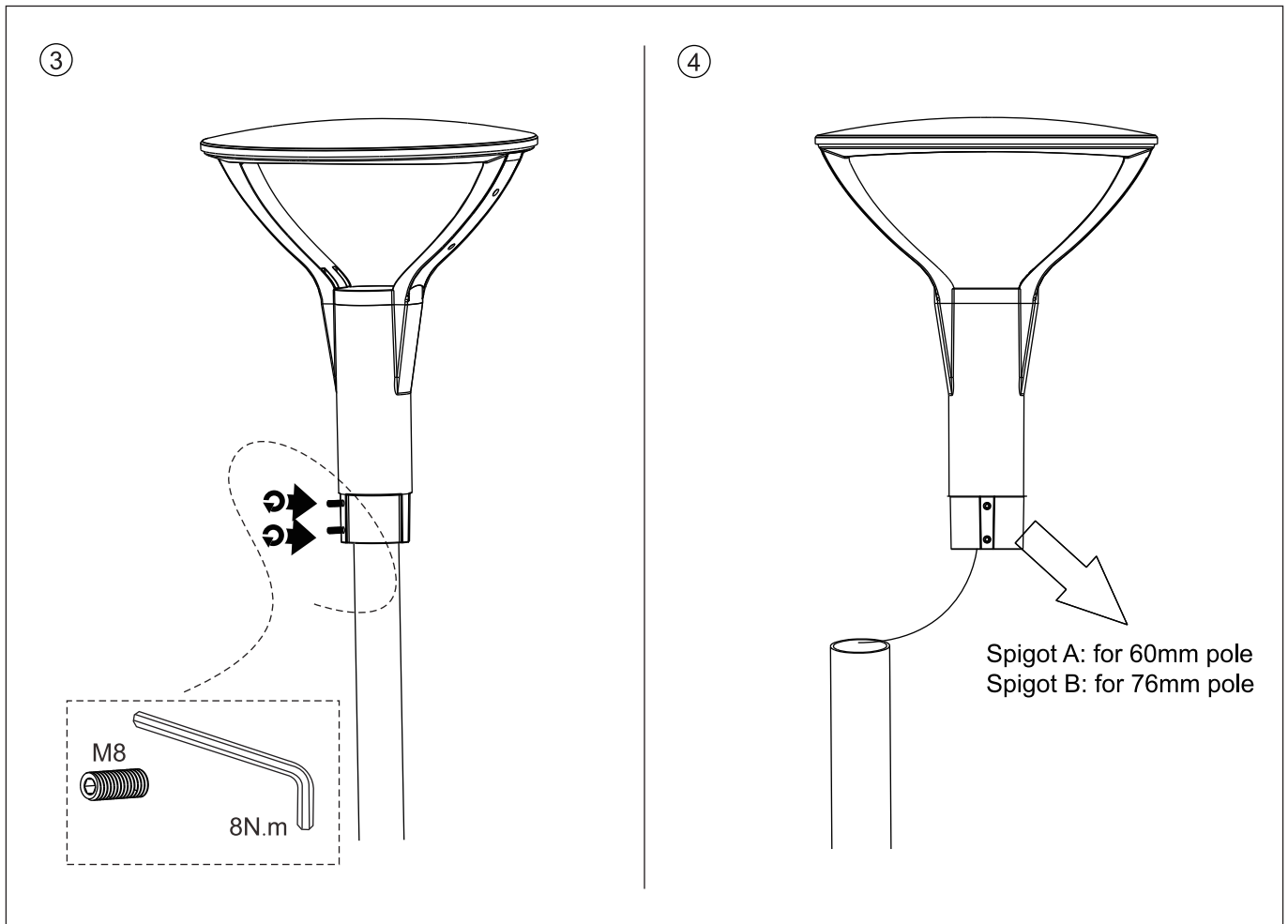

Caution: Any operation on LED module is forbidden while power-on.  
Zur Vermeidung von Risiken müssen defekte Leitungen ausschließlich vom Hersteller, Inverkehrbringer oder Fachmann ausgetauscht werden.  
Achtung: In Betrieb ist keine Arbeit am LED-Modul erlaubt.



For non-user replaceable light sources:  
The light source contained in this luminaire shall only be replaced by the manufacturer or his service agent or a similar qualified person.  
Das Leuchtmittel dieser Leuchte ist nicht austauschbar. Wenn das Leuchtmittel das Ende seiner Lebensdauer erreicht hat, muss die gesamte Leuchte ersetzt werden.



For use in environments where normal non-conductive/conductive dust accumulation may be expected, not for use in environments with expected high/unusual dust accumulation.

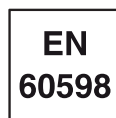
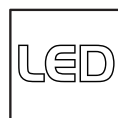
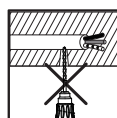
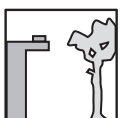

Data subject to change  
Les données sont sujettes à modifications  
Änderungen vorbehalten

Oppl Lighting Electronic (Zhongshan) Co., Ltd.  
Building A, No.275 Dongan Bei Road, Haizhou District,  
Guzhen Town, Zhongshan City, Guangdong, China.

OPPLE Lighting B.V.  
Meerenakkerweg 1.11  
5652 AR Eindhoven  
The Netherlands  
service@opple.com  
www.opple.com