



UP&DOWN TRANSLUCENT DIMMABLE PANEL

Typology

Translucent LED panel with double emission, dimmable.

Features

Fixture with visual interest characterised by dual emission - 50% downwards and 50% upwards - along with the translucency of the panel itself.

Material

White frame with methacrylate panel.

Power supply

The luminaire comes complete with a remote power supply integrated into one of two white metal parallelepipeds to be fixed to the ceiling.

Notes

Adjustable suspension wires: MAX 150 cm.
Cable attachment with screw and steel cylinder.

Connections

Use 0-10V dimmers.

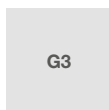
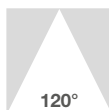
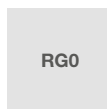
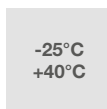
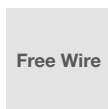
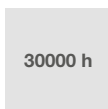
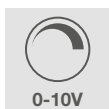
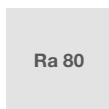
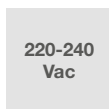
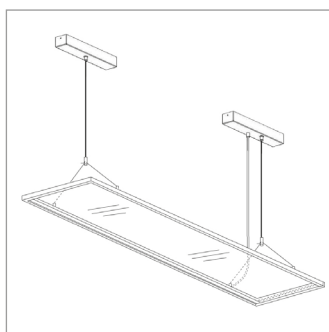

Characteristic data

Power	40 W	Beam	120°	Dimmable	0-10V	Input	220-240 Vac
Base	Free Wire	IP	20	Flux	4000 lm	PF	0.95
Tc	4000 K	Ra	80	LED Warranty	G3	RG	RG0

Dimensional characteristics

L	1200 mm
L1	300 mm
H	14.5 mm

Lighting and photometric features

Beam opening	120°
Flux	4000 lm
CCT nominal colour temperature	4000 K
Colour of the light	Natural light
Colour rendering index	80
Lifespan	30000 h
LED lifespan	L70 B20
Trigger time	<0,2 s
Heating time up to 60% of full efficiency	Instant Full Light

Electrical characteristics

Rated power	40 W
Input voltage	220-240 Vac
Frequency	50-60 Hz
Dimmable	0-10V
Power factor (PF)	0.95
Operating temperature	-25°C / +40°C

Photometry

[EuLumDat file on the site](#)

Other Infotech

Flicker Free	Yes
--------------	-----

LED Warranty

G3	Up to 3 years (4000h/year) *4000h = 11h a day x 365 days. Without limitations on the duration of use for the first year, provided the observance of the installation conditions.
----	--

Standards and Directives

2009/125/EC, 1194/2012, 2015/1428, 2010/30/EU	CEI EN 61000-3-3:2014
874/2012, 2011/65/EU, 2012/19/EU, 2014/30/EU	CEI EN 61547:2010
2014/35/EU, 2015/863	CEI EN 62031:2009
CEI EN 55015:2020	CEI EN 62031/A1/A2:2015
CEI EN 60598-1:2015	CEI EN 62471:2010
CEI EN 60598-1/A1:2019	IEC TR 62471-2:2009
CEI EN 60598-2-2:2012	CEI EN 62493:2015
CEI EN 61000-3-2:2019	CEI 34-141:2014

Logistics data

Item net weight	3800 gr
Barcode single item	8011905984274
Number of pieces multiple pack	5
Barcode multiple pack	8011905985714
Minimum order quantity	5
Minimum packaging	5