



## Roadlight

- Modern-looking Roadlight solution with robust die-cast aluminium body
- Up to 60% energy saving compared to HID roadlights
- Advanced optical design optimized for road lighting
- Flexible and adjustable pole connector for both side entry and pole top mounting
- IP66 and suitable for use on the coastal applications
- Including 10m H07RN-F rubber cable 5x1,5mm<sup>2</sup> pre-assembled for faster installation
- Double pole-top adapter available as accessory



Separate Roadlight Pole Adapter (543098007000 or 599006051700) is necessary to be ordered with Roadlight to install the product, also when combined with other accessories.

## Specifications

Item Code	Item Description	Equivalent to (W)	Power (W)	Lumen	Efficacy (lm/W)	CCT (K)	Weight (kg/pc)
DALI							
543014005700	LEDRoadlight-120W-4000-DALI	HID 150W	120	15000	125	4000	9.20

For more technical information, please go to the appendix.

## Accessories



543098007000  
Pole Adapter-Roadlight-60mm



599006051700  
Pole Adapter-Roadlight-76mm



705098003600  
LEDStreetlight Wall-Bracket-60



705098003700  
LEDStreetlight Pole-Top-60-Adapter-60



705098003400  
LEDStreetlight Pole-Top-76-Adapter-60



705098005500  
LEDStreetlight Pole-Top-60-Adapter-2x60



543098022000  
LEDFixture-IP68-Connector-Kit-5

## Packaging Information

Item			Box			
Item Code	Item Description	Commodity Code	Dimensions (mm) (LxWxH)	Gross Weight (kg)	EAN	pc/box
543014005700	LEDRoadlight-120W-4000-DALI	94054239	645x310x98	9.60	6956321824013	1
543098007000	Pole Adapter-Roadlight-60mm	94059900	111x106x137	0.40	6956321811129	1
543098022000	LEDFixture-IP68-Connector-Kit-5	73121049	265x245x205	3.16	6941497708984	1
599006051700	Pole Adapter-Roadlight-76mm	94059900	119x199x237	1.06	6956321897468	1
705098003400	LEDStreetlight Pole-Top-76-Adapter-60	94059900	223x116x314	1.62	6941497755100	1
705098003600	LEDStreetlight Wall-Bracket-60	94059900	201x78x239	1.05	6941497755124	1
705098003700	LEDStreetlight Pole-Top-60-Adapter-60	94059900	215x97x301	1.45	6941497755117	1
705098005500	LEDStreetlight Pole-Top-60-Adapter-2x60	94059900	505x97x230	2.31	6941491705491	1

### Technical Specifications

Lifetime (L70)	100,000 h
Lifetime (L80)	70,000 h
On-/Off-cycles	100,000
Colour consistency (SDCM)	6
Dimmability	DALI
Beam angle	150° x 70°
Maximum tilt angle	15°
Finishing	Grey
Colour rendering index CRI	≥ 80
Degree of protection (IP)	IP66
Impact strength	IK08
Protection class	I
Risk group (EN 62471)	RG1
With control gear	Yes
Glow wire test	850°C
Driver failure rate (at 5,000 hrs)	0.5 %
Power factor	≥ 0.9
Surge protection	10 kV

### Electrical Supply

Frequency	50/60 Hz
Nominal voltage	220-240 V AC
DC input voltage	See catalogue appendix Connection Specifications
230V Cable length	10 m

### Mechanical Properties

Housing material	Aluminium
Optical material	Polycarbonate
Compatible pole Ø	48-76 mm
Effective wind area	1478 cm <sup>2</sup>
Coastal proof	Yes

### Ambient Conditions

Operating temperature	-30-+50°C
Application temperature	+25°C
Storage environment	-30-+65°C

**5 YEARS WARRANTY**



**ENERGY**

OPPLE Lighting  
543014005700

A  
B  
C  
D  
**E**  
F  
G

**120**  
kWh/1000h

2019/2015

## Dimensional Drawing (mm)

LEDRoadlight

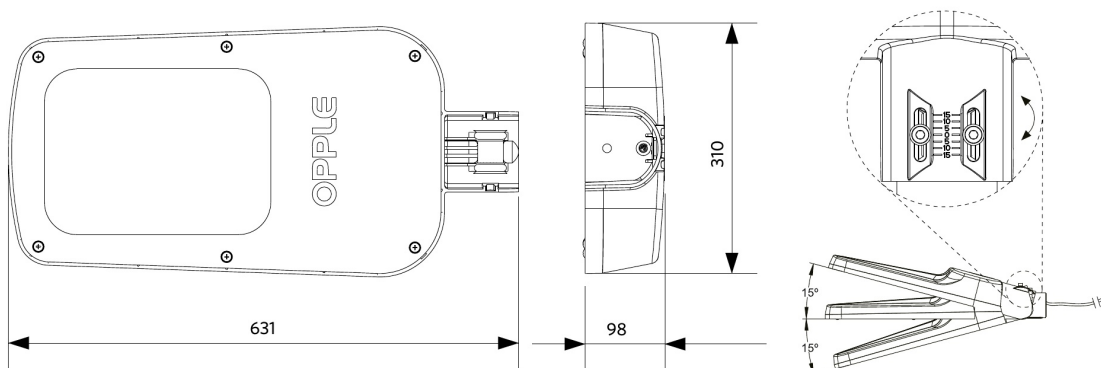

Pole Adapter-Roadlight-60mm

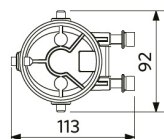
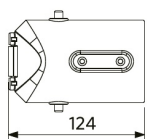

Pole Adapter-Roadlight-76mm

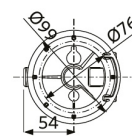
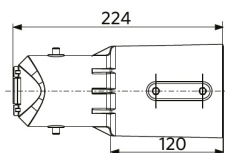

## Photometric Data

