



Waterproof EcoMax G3

- Waterproof luminaire in "sealed-for-life" concept
- Improved installation due to new twist-and-lock endcap
- Supplied with vandal-proof stainless steel ceiling and suspension clips
- Equipped with 3x25mm² throughwiring



Specifications

Item Code	Item Description	Equivalent to (W)	Power (W)	Lumen	Efficacy (lm/W)	CCT (K)	Weight (kg/pc)
On-Off							
531000012400	LEDWaterproof-E3 L1500-44/55W-865	TL 1/2x58W	44/55	6600/8250	150	6500	0.97

Packaging Information

Item			Box			
Item Code	Item Description	EU HS Code	Dimensions (mm) (LxWxH)	Gross Weight (kg)	EAN	pc/box
531000012400	LEDWaterproof-E3 L1500-44/55W-865	94051190	1611x67x66	1.46	6931783027837	1

Technical Specifications

Lifetime (L70)	70,000 h
Lifetime (L80)	50,000 h
On-/Off-cycles	100,000
Colour consistency (SDCM)	4
Dimmability	On-Off
Beam angle	120°
Finishing	Grey RAL 7035
Colour rendering index (CRI)	> 80
Degree of protection (IP)	IP66
Impact strength	IK08
Protection class	II
Risk group (EN 62471)	RG0
With control gear	Yes
Glow wire test	850°C
Power factor	≥ 0.9
Input wire diameter	1mm ² - 2.5mm ²
Internal wiring (mm ²)	3x2.5
Max. input cable diameter (mm)	7-11.5 mm

Electrical Supply

Frequency	50/60 Hz
Nominal voltage	220-240 V
DC input voltage	See catalogue appendix
Connection	Specifications

Mechanical Properties

Material housing	Polycarbonate
UV resistant	Yes
Optical material	Polycarbonate
Mounting clips	Stainless steel

Ambient Conditions

Operating temperature	-20-+45°C
Application temperature	+25°C
Storage environment	-30-+60°C



Dimensional Drawing (mm)

LEDWaterproof-E3 L1500

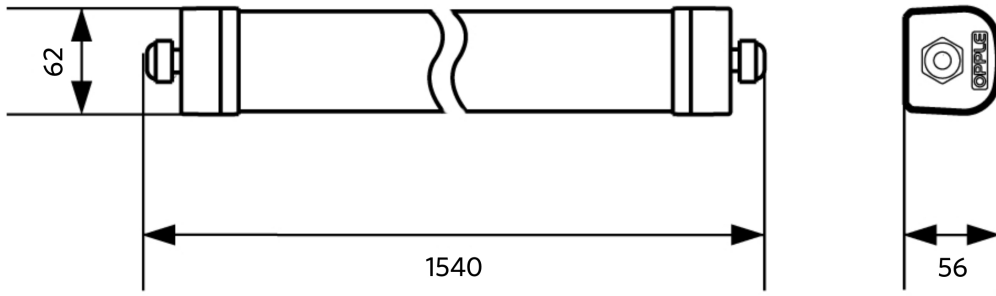

Installation Possibilities

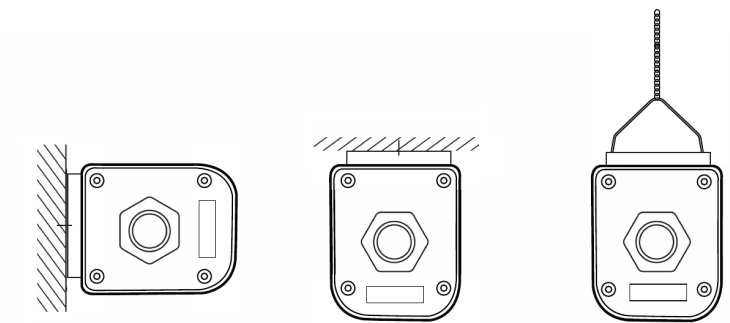

Photometric Data

