

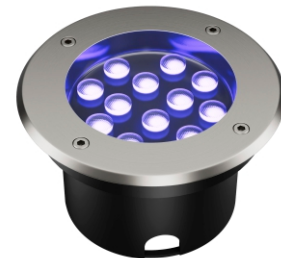

MLX UG WALKY LED TAPOSÓ LÁMPA 24 V

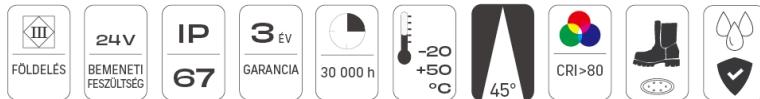

HL0019921 HL0019943
HL0019936 HL0019944
HL0019937 HL0019824
HL0019938 HL0019920
HL0019939 HL0019945
HL0019940 HL0019946
HL0019941 HL0019947
HL0019942 HL0019948



36W



24W



18W



12W



9W



6W



3W





MLX UG WALKY LED TAPOSÓ LÁMPA 24 V

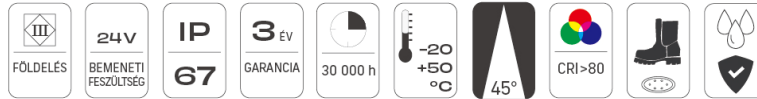

304 stainless steel face ring



LED driver inside

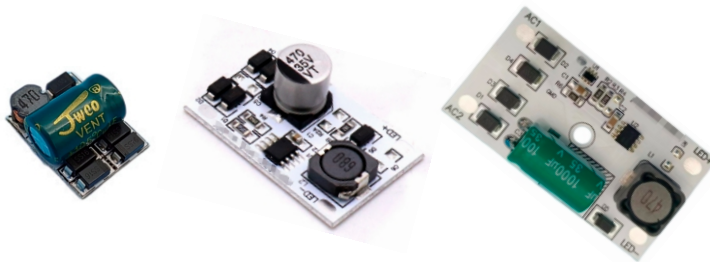

Potting waterproofing



Color temperature



White(6000K/4000K/3000K)

Red



Blue

Yellow

Green

RGB



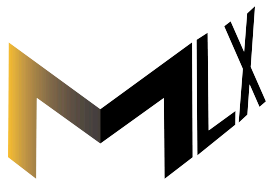

MLX UG WALKY LED TAPOSÓ LÁMPA 24 V

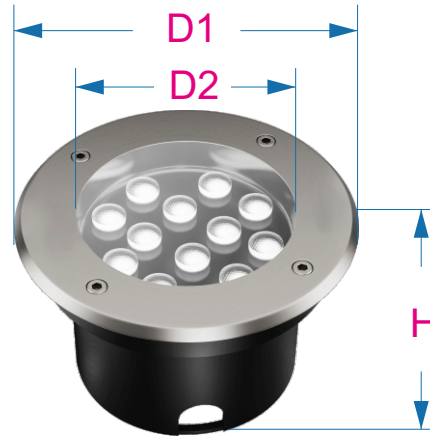
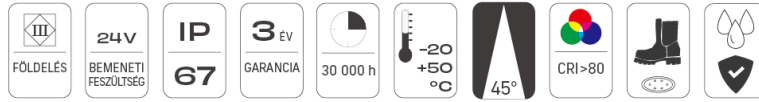

	Power	Product Size(D1*H)	Surface Size(D2)	Hole Size
	3W	Φ100*H90mm	Φ58mm	Φ95mm
	6W	Φ120*H90mm	Φ80mm	Φ115mm
	9W	Φ160*H95mm	Φ100mm	Φ145mm
	12W	Φ180*H90mm	Φ115mm	Φ155mm
	18W	Φ200*H90mm	Φ146mm	Φ185mm
	24W	Φ220*H90mm	Φ165mm	Φ205mm
	36W	Φ250*H90mm	Φ190mm	Φ240mm
	48W	Φ300*H94mm	Φ240mm	Φ285mm





MLX UG WALKY LED TAPOSÓ LÁMPA 24 V

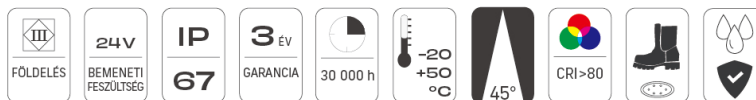

3W

Input Voltage	Max.Current	Operating Voltage	Constant Current	Power	Factor				
AC/DC24V	0.125A	DC18V	0.15A	3W ± 10%	≥ 0.5				
LED Type	LED Q'ty	CRI	CCT	2900-3100K	4000-4500K	5500-6000K	Wave length		
			Luminous efficiency	75LM/W	80LM/W	80LM/W	Red	Green	Blue
SMD2835	3 PCS	≥ 80Ra	Luminous flux	225LM±10%	240LM±10%	240LM±10%	620-625nm	517-522nm	456-460nm
			Beam Angle	45° 【30° / 60° / 90° / 120° Optional】					
Life Time	Certifications	IP Code	Luminaires Class	product dimension	N.W				
30.000Hours	CE,RoHS	IP67	ClassIII	Φ100*90mm	0.39Kg				
Operating Temperature	Storage Temperature	Lamp Body Material	Lamp Shade Material	Packing dimension	G.W				
-20°Cto+50°C	-30°Cto+60°C	304 Stainless Steel	304 Stainless Steel	L105*W105*H100mm	0.41Kg				
Outer carton package	50*1layer=50PCS/carton,K=K corrugated paper, L540*W225*H525mm,GW:22.4KG								

6W

Input Voltage	Max.Current	Operating Voltage	Constant Current	Power	Factor				
AC/DC24V	0.25A	DC18V	0.3A	6W ± 10%	≥ 0.5				
LED Type	LED Q'ty	CRI	CCT	2900-3100K	4000-4500K	5500-6000K	Wave length		
			Luminous efficiency	75LM/W	80LM/W	80LM/W	Red	Green	Blue
SMD2835	6 PCS	≥ 80Ra	Luminous flux	450LM±10%	480LM±10%	480LM±10%	620-625nm	517-522nm	456-460nm
			Beam Angle	45° 【30° / 60° / 90° / 120° Optional】					
Life Time	Certifications	IP Code	Luminaires Class	product dimension	N.W				
30.000Hours	CE,RoHS	IP67	ClassIII	Φ120*90mm	0.64Kg				
Operating Temperature	Storage Temperature	Lamp Body Material	Lamp Shade Material	Packing dimension	G.W				
-20°Cto+50°C	-30°Cto+60°C	304 Stainless Steel	304 Stainless Steel	L125*W100*H125mm	0.67Kg				
Outer carton package	30*1layer=30PCS/carton,K=K corrugated paper, L520*W265*H395mm,GW:18.8KG								





MLX UG WALKY LED TAPOSÓ LÁMPA 24 V

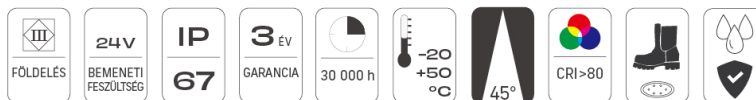

9W

Input Voltage	Max. Current	Operating Voltage	Constant Current	Power	Factor				
AC/DC24V	0.375A	DC18V	0.45A	9W ± 10%	≥ 0.5				
LED Type	LED Q'ty	CRI	CCT	2900-3100K	4000-4500K	5500-6000K	Wave length		
			Luminous efficiency	75LM/W	80LM/W	80LM/W	Red	Green	Blue
SMD2835	9 PCS	≥ 80Ra	Luminous flux	675LM±10%	720LM±10%	720LM±10%	620-625nm	517-522nm	456-460nm
			Beam Angle	45° 【30° / 60° / 90° / 120° Optional】					
Life Time	Certifications	IP Code	Luminaires Class	product dimension	N.W				
30.000Hours	CE, RoHS	IP67	ClassIII	Φ160*95mm	1.01Kg				
Operating Temperature	Storage Temperature	Lamp Body Material	Lamp Shade Material	Packing dimension	G.W				
-20°C to +50°C	-30°C to +60°C	304 Stainless Steel	304 Stainless Steel	L160*W95*H185mm	1.06Kg				
Outer carton package	20*1layer=20PCS/carton, K=K corrugated paper, L500*W335*H395mm, GW:18.8KG								

12W

Input Voltage	Max. Current	Operating Voltage	Constant Current	Power	Factor				
AC/DC24V	0.5A	DC18V	0.6A	12W ± 10%	≥ 0.5				
LED Type	LED Q'ty	CRI	CCT	2900-3100K	4000-4500K	5500-6000K	Wave length		
			Luminous efficiency	75LM/W	80LM/W	80LM/W	Red	Green	Blue
SMD2835	12 PCS	≥ 80Ra	Luminous flux	900LM±10%	960LM±10%	960LM±10%	620-625nm	517-522nm	456-460nm
			Beam Angle	45° 【30° / 60° / 90° / 120° Optional】					
Life Time	Certifications	IP Code	Luminaires Class	product dimension	N.W				
30.000Hours	CE, RoHS	IP67	ClassIII	Φ180*90mm	1.19Kg				
Operating Temperature	Storage Temperature	Lamp Body Material	Lamp Shade Material	Packing dimension	G.W				
-20°C to +50°C	-30°C to +60°C	304 Stainless Steel	304 Stainless Steel	L190*W100*H185mm	1.25Kg				
Outer carton package	20*1layer=20PCS/carton, K=K corrugated paper, L520*W390*H390mm, GW:23.2KG								





MLX UG WALKY LED TAPOSÓ LÁMPA 24 V

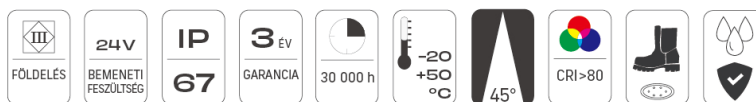

18W

Input Voltage	Max.Current	Operating Voltage	Constant Current	Power	Factor				
AC/DC24V	0.75A	DC18V	0.9A	18W±10%	≥0.5				
LED Type	LED Q'ty	CRI	CCT	2900-3100K	4000-4500K	5500-6000K	Wave length		
			Luminous efficiency	75LM/W	80LM/W	80LM/W	Red	Green	Blue
			Luminous flux	1350LM±10%	1440LM±10%	1440LM±10%	620-625nm	517-522nm	456-460nm
			Beam Angle	45° 【30° / 60° / 90° / 120° Optional】					
Life Time	Certifications	IP Code	Luminaires Class	product dimension	N.W				
30.000Hours	CE,RoHS	IP67	ClassIII	Φ200*90mm	1.53Kg				
Operating Temperature	Storage Temperature	Lamp Body Material	Lamp Shade Material	Packing dimension	G.W				
-20°Cto+50°C	-30°Cto+60°C	304 Stainless Steel	304 Stainless Steel	L195*W115*H220mm	1.61Kg				
Outer carton package	12*1layer=12PCS/carton,K=K corrugated paper, L600*W250*H460mm,GW:17.4KG								

24W

Input Voltage	Max.Current	Operating Voltage	Constant Current	Power	Factor				
AC/DC24V	1.0A	DC18V	1.2A	24W±10%	≥0.5				
LED Type	LED Q'ty	CRI	CCT	2900-3100K	4000-4500K	5500-6000K	Wave length		
			Luminous efficiency	75LM/W	80LM/W	80LM/W	Red	Green	Blue
			Luminous flux	1800LM±10%	1920LM±10%	1920LM±10%	620-625nm	517-522nm	456-460nm
			Beam Angle	45° 【30° / 60° / 90° / 120° Optional】					
Life Time	Certifications	IP Code	Luminaires Class	product dimension	N.W				
30.000Hours	CE,RoHS	IP67	ClassIII	Φ220*90mm	1.84Kg				
Operating Temperature	Storage Temperature	Lamp Body Material	Lamp Shade Material	Packing dimension	G.W				
-20°Cto+50°C	-30°Cto+60°C	304 Stainless Steel	304 Stainless Steel	L225*W100*H225mm	1.92Kg				
Outer carton package	10*1layer=10PCS/carton,K=K corrugated paper, L520*W240*H470mm,GW:17.6KG								





MLX UG WALKY LED TAPOSÓ LÁMPA 24 V

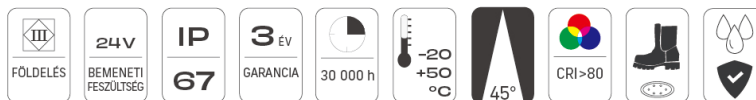

36W

Input Voltage	Max. Current	Operating Voltage	Constant Current	Power	Factor				
AC/DC24V	1.5A	DC18V	0.9A*2	36W ± 10%	≥ 0.5				
LED Type	LED Q'ty	CRI	CCT	2900-3100K	4000-4500K	5500-6000K	Wave length		
			Luminous efficiency	75LM/W	80LM/W	80LM/W	Red	Green	Blue
SMD2835	36 PCS	≥ 80Ra	Luminous flux	2700LM ± 10%	2880LM ± 10%	2880LM ± 10%	620-625nm	517-522nm	456-460nm
			Beam Angle	45° 【30° / 60° / 90° / 120° Optional】					
Life Time	Certifications	IP Code	Luminaires Class	product dimension	N.W				
30.000Hours	CE, RoHS	IP67	Class III	Φ250*90mm	2.42Kg				
Operating Temperature	Storage Temperature	Lamp Body Material	Lamp Shade Material	Packing dimension	G.W				
-20°C to +50°C	-30°C to +60°C	304 Stainless Steel	304 Stainless Steel	L305*W100*H305mm	2.55Kg				
Outer carton package	8*1layer=8PCS/carton, K=K corrugated paper, L420*W270*H530mm, GW: 18.65KG								

48W

Input Voltage	Max. Current	Operating Voltage	Constant Current	Power	Factor				
AC/DC24V	2.0A	DC18V	1.2A*2	48W ± 10%	≥ 0.5				
LED Type	LED Q'ty	CRI	CCT	2900-3100K	4000-4500K	5500-6000K	Wave length		
			Luminous efficiency	75LM/W	80LM/W	80LM/W	Red	Green	Blue
SMD2835	48 PCS	≥ 80Ra	Luminous flux	3600LM ± 10%	3840LM ± 10%	3840LM ± 10%	620-625nm	517-522nm	456-460nm
			Beam Angle	45° 【30° / 60° / 90° / 120° Optional】					
Life Time	Certifications	IP Code	Luminaires Class	product dimension	N.W				
30.000Hours	CE, RoHS	IP67	Class III	Φ300*90mm	3.8Kg				
Operating Temperature	Storage Temperature	Lamp Body Material	Lamp Shade Material	Packing dimension	G.W				
-20°C to +50°C	-30°C to +60°C	304 Stainless Steel	304 Stainless Steel	L355*W100*H355mm	4.0Kg				
Outer carton package	4*1layer=4PCS/carton, K=K corrugated paper, L420*W370*H370mm, GW: 17KG								





MLX UG WALKY LED TAPOSÓ LÁMPA 24 V

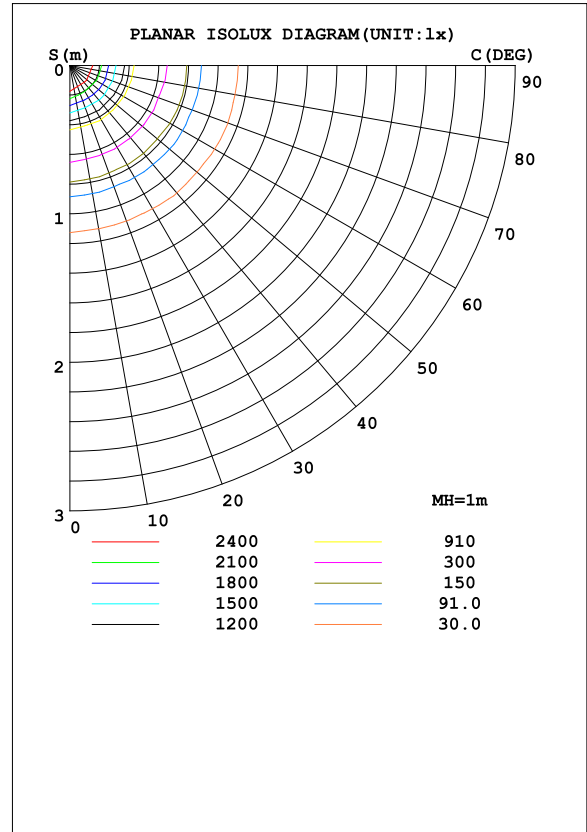
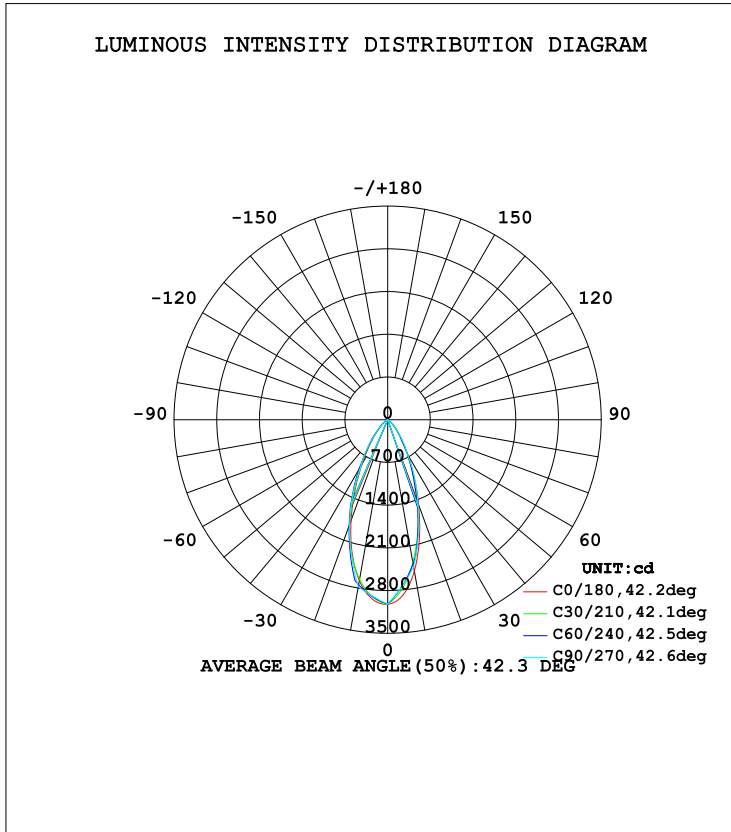

AC/DC24V Input: V+ -Brown
V- -Blue

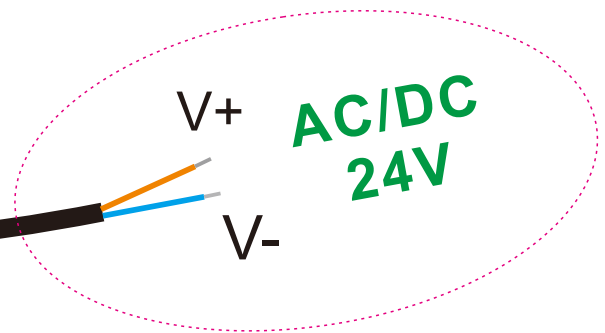

Ne csatlakoztasson 230 V-os vagy 24 V-nál magasabb AC feszültséget, különben a lámpa károsodhat.



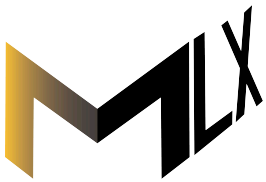

MLX UG WALKY LED TAPOSÓ LÁMPA 24 V



Esztétikus:

A taposólámpák talajszint alá telepíthetők, nem foglalnak el helyet és nem zavarják a táj szépségét.

Energiatakarékos:

LED fényforrásokat használnak, amelyek hatékonyak és energiatakarékosak, csökkentve az energiafogyasztást.

Tartós:

Kiváló minőségű rozsdamentes acélból vagy alumíniumötvözetből készülnek, vízálló, korrózióálló tulajdonságokkal rendelkeznek, így hosszú élettartamot biztosítanak.

Biztonságos:

Alacsony feszültségű egyenáramú tápegységet használnak, amely nem bocsát ki elektromágneses impulzusokat és hőszugárzást, így biztonságosak és megbízhatóak.

Széleskörű felhasználási módok:

A taposólámpák a szín és a fényerő, valamint más paraméterek, szerint állíthatók be, és számos alkalmazási forgatókönyvhöz igazíthatók, például kertvilágításhoz, tájvilágításhoz, térvilágításhoz és épületvilágításhoz.

A taposólámpákat széles körben használják köztereken, éttermekben, magánvillákban, kertekben, konferenciatermekben, kiállítótermekben, közösségi tereprendezésben, színpadi bárókban, bevásárlóközpontokban, parkolósobrokban, turisztikai látványosságokban és más helyeken, például fénydekorációkban.

